



Industrial Automation Headquarters

Delta Electronics, Inc.
Taoyuan Technology Center
No.18, Xinglong Rd., Taoyuan City,
Taoyuan County 33068, Taiwan
TEL: 886-3-362-6301 / FAX: 886-3-371-6301

Asia

Delta Electronics (Jiangsu) Ltd.
Wujiang Plant 3
1688 Jiangxing East Road,
Wujiang Economic Development Zone
Wujiang City, Jiang Su Province, P.R.C. 215200
TEL: 86-512-6340-3008 / FAX: 86-769-6340-7290

Delta Greentech (China) Co., Ltd.
238 Min-Xia Road, Pudong District,
Shanghai, P.R.C. 201209
TEL: 86-21-58635678 / FAX: 86-21-58630003

Delta Electronics (Japan), Inc.
Tokyo Office
2-1-14 Minato-ku Shibadaimon,
Tokyo 105-0012, Japan
TEL: 81-3-5733-1111 / FAX: 81-3-5733-1211

Delta Electronics (Korea), Inc.
1511, Byucksan Digital Valley 6-cha, Gasan-dong,
Geumcheon-gu, Seoul, Korea, 153-704
TEL: 82-2-515-5303 / FAX: 82-2-515-5302

Delta Electronics Int'l (S) Pte Ltd.
4 Kaki Bukit Ave 1, #05-05, Singapore 417939
TEL: 65-6747-5155 / FAX: 65-6744-9228

Delta Electronics (India) Pvt. Ltd.
Plot No 43 Sector 35, HSIIDC
Gurgaon, PIN 122001, Haryana, India
TEL : 91-124-4874900 / FAX : 91-124-4874945

Americas

Delta Products Corporation (USA)
Raleigh Office
P.O. Box 12173, 5101 Davis Drive,
Research Triangle Park, NC 27709, U.S.A.
TEL: 1-919-767-3800 / FAX: 1-919-767-8080

Delta Greentech (Brasil) S.A.
Sao Paulo Office
Rua Itapeva, 26 - 3º andar Edifício Itapeva One-Bela Vista
01332-000-São Paulo-SP-Brazil
TEL: 55 11 3568-3855 / FAX: 55 11 3568-3865

Europe

Delta Electronics (Netherlands) B.V.
Eindhoven Office
De Witbogt 20, 5652 AG Eindhoven, The Netherlands
TEL : +31 (0)40-8003800 / FAX : +31 (0)40-8003898

DVP-0191920-02

2020-01-13

*We reserve the right to change the information in this manual without prior notice.

DVP-15MC Series Motion Controller Operation Manual



DVP-15MC Series Motion Controller Operation Manual

www.deltaww.com



DVP-15MC Series Motion Controller

Operation Manual

Table of Contents

Chapter 1	Preface	
1.1	Explanation of Symbols in This Manual	1-2
1.2	Revision History	1-2
Chapter 2	Overview	
1.1	Product Description.....	2-2
1.2	Functions	2-2
1.3	Profile and Components	2-3
Chapter 3	Specifications	
3.1	Function Specifications	3-2
3.1.1	Specifications	3-2
3.1.2	Devices and Data Types.....	3-3
3.1.2.1	Devices.....	3-3
3.1.2.2	Valid Ranges of Devices	3-4
3.1.2.3	Latched Devices	3-5
3.1.2.4	Data Types and Valid Ranges Supported	3-6
3.2	Electrical Specifications	3-7
Chapter 4	System Architecture	
4.1	System Constitution	4-2
4.2	Power Supply	4-2
4.3	Left-side Extension	4-2
4.3.1	Connectable Left-side Extension Module	4-2
4.3.2	Allocation of Left-side Network Module Addresses	4-3
4.3.3	Method of Reading/Writing of Left-side Modules	4-3
4.4	Right-side Extension	4-3

4.4.1	Connectable Right-side Extension Modules.....	4-3
4.4.2	Allocation of Right-side Extension Module Addresses.....	4-4
4.5	Connectable Servo Drives	4-5
4.6	SD Memory Card	4-7
4.6.1	Model and Specification.....	4-7
Chapter 5 Installation		
5.1	Dimensions	5-2
5.1.1	Profile and Dimensions.....	5-2
5.1.2	Dimensions of Left-side and Right-side Extension Modules.....	5-2
5.1.3	Connecting to the Left-side Extension Module	5-3
5.1.4	Connecting to the Right-side Extension Module	5-4
5.1.5	Installing and Removing the SD Card	5-5
5.2	Installing the Module in the Control Cabinet	5-7
5.2.1	Installing the Module to DIN rail.....	5-7
5.2.2	Illustration of Installation Inside the Control Cabinet.....	5-7
5.2.3	Environmental Temperature in the Control Cabinet	5-7
5.2.4	Actions for Anti-interference	5-8
5.2.5	Dimension Requirement in the Control Cabinet	5-8
Chapter 6 Wiring, Communication Setting and Network Construction		
6.1	Wiring	6-3
6.1.1	Power Supply.....	6-3
6.1.2	Safety Circuit Wiring.....	6-4
6.2	Input Point and Output Point Wiring.....	6-5
6.2.1	Function that Input Points Support	6-5
6.2.2	Input Point Wiring	6-6
6.2.3	Output Point Wiring	6-8
6.3	RS-485 Communication Port	6-9
6.3.1	Function that RS-485 Port Supports.....	6-9
6.3.2	Definitions of RS-485 Port Pins.....	6-9
6.3.3	RS-485 Hardware Connection	6-9
6.3.4	Supported Function Codes and Exception Codes	6-10
6.4	RS-232 Communication Port	6-11

6.4.1	Function that RS-232 Port Supports	6-11
6.4.2	Definitions of RS-232 Port Pins	6-11
6.4.3	RS-232 Hardware Connection	6-12
6.4.4	Supported Function Codes and Exception Codes	6-12
6.5	SSI Absolute Encoder Port	6-13
6.5.1	Function of SSI Absolute Encoder	6-13
6.5.2	Definitions of SSI Port Pins	6-13
6.5.3	SSI Absolute Encoder Hardware Connection.....	6-14
6.6	Incremental Encoders	6-15
6.6.1	Function of Incremental Encoder	6-15
6.6.2	Definition of Incremental Encoder Port Pins.....	6-15
6.6.3	Incremental Encoder Hardware Connection.....	6-16
6.7	Ethernet Communication Port	6-17
6.7.1	Function that Ethernet Communication Port Supports.....	6-17
6.7.2	Pins of Ethernet Communication Port	6-17
6.7.3	Network Connection of Ethernet Communication Port.....	6-17
6.7.4	Function Codes that Ethernet Communication Port Supports	6-18
6.8	Motion Communication Port	6-18
6.8.1	Function that Motion Communication Port Supports	6-18
6.8.2	Pins of Motion Communication Port	6-18
6.8.3	Motion Network Connection	6-19
6.8.4	Communication Speed and Communication Distance.....	6-19
6.9	CANopen Communication Port.....	6-20
6.9.1	Functions that CANopen Communication Port Supports	6-20
6.9.2	Pins of CANopen Communication Port.....	6-21
6.9.3	PDO Mapping at CANopen Communication Port	6-21
6.9.4	Network Connection at CANopen Communication Port	6-21
6.9.5	CANopen Communication Rate and Communication Distance	6-22
Chapter 7 Execution Principle		
7.1	Tasks.....	7-2
7.1.1	Task Types	7-2
7.1.2	Priority levels of Tasks	7-4
7.1.3	Watchdog for a Task	7-6

7.1.4	Motion Instructions for Each Task Type	7-7
7.2	The Impact of PLC RUN or STOP on Variables and Devices.....	7-8
7.3	Relationship between Motion Program and Motion Bus.....	7-8
7.4	Synchronization Cycle Period Setting.....	7-9
Chapter 8 Logic Instructions		
8.1	Table of Logic Instructions.....	8-6
8.2	Explanation of Logic Instructions.....	8-10
8.2.1	EN and ENO	8-10
8.3	Sequence Input /Output Instructions	8-10
8.3.1	R_TRIG	8-10
8.3.2	F_TRIG.....	8-12
8.3.3	RS	8-14
8.3.4	SR	8-16
8.3.5	SEMA	8-18
8.4	Sequence Control Instructions.....	8-20
8.4.1	JMP.....	8-20
8.5	Data Movement Instructions.....	8-21
8.5.1	MOVE.....	8-21
8.5.2	MoveBit.....	8-22
8.5.3	TransBit	8-24
8.5.4	MoveDigit	8-26
8.5.5	Exchange.....	8-28
8.5.6	Swap	8-30
8.6	Comparison Instructions.....	8-32
8.6.1	LT8-32	
8.6.2	LE8-34	
8.6.3	GT	8-36
8.6.4	GE	8-38
8.6.5	EQ	8-40
8.6.6	NE	8-42
8.7	Timer Instructions	8-44

8.7.1	TON	8-44
8.7.2	TOF	8-46
8.7.3	TP8-48	
8.7.4	Sys_ReadTime.....	8-50
8.7.5	Sys_ReadTotalWorkTime	8-51
8.7.6	Sys_ReadPowerOnTime	8-52
8.7.7	Sys_WdgStatus	8-53
8.8	Counter Instructions	8-55
8.8.1	CTU	8-55
8.8.2	CTD	8-57
8.8.3	CTUD	8-59
8.9	Math Instructions.....	8-62
8.9.1	ADD	8-62
8.9.2	SUB	8-65
8.9.3	MUL	8-68
8.9.4	DIV	8-71
8.9.5	MOD	8-74
8.9.6	MODREAL	8-76
8.9.7	MODTURNS.....	8-78
8.9.8	MODABS.....	8-80
8.9.9	ABS	8-82
8.9.10	DegToRad.....	8-84
8.9.11	RadToDeg.....	8-86
8.9.12	SIN.....	8-88
8.9.13	COS	8-90
8.9.14	TAN	8-92
8.9.15	ASIN.....	8-94
8.9.16	ACOS.....	8-96
8.9.17	ATAN	8-98
8.9.18	LN	8-100
8.9.19	LOG	8-102
8.9.20	SQRT	8-104
8.9.21	EXP	8-106
8.9.22	EXPT.....	8-108
8.9.23	RAND.....	8-110

8.9.24	TRUNC	8-112
8.9.25	FLOOR	8-114
8.9.26	FRACTION	8-116
8.10	Bit String Instructions	8-118
8.10.1	AND.....	8-118
8.10.2	OR.....	8-121
8.10.3	NOT.....	8-124
8.10.4	XOR.....	8-126
8.10.5	XORN.....	8-129
8.11	Shift Instructions.....	8-132
8.11.1	SHL	8-132
8.11.2	SHR.....	8-134
8.11.3	ROL	8-136
8.11.4	ROR.....	8-138
8.12	Selection Instructions.....	8-140
8.12.1	MAX.....	8-140
8.12.2	MIN	8-142
8.12.3	SEL	8-145
8.12.4	MUX	8-147
8.12.5	LIMIT.....	8-149
8.12.6	BAND.....	8-151
8.12.7	ZONE.....	8-154
8.13	Data Type Conversion Instructions	8-157
8.13.1	BOOL_TO_***	8-157
8.13.2	Bit strings_TO_***	8-160
8.13.3	Integers_TO_***	8-167
8.13.4	Real numbers_TO_***	8-176
8.13.5	Times,dates_TO_***	8-179
8.13.6	Strings_TO_***	8-181
8.14	Communication Instructions.....	8-184
8.14.1	CANopen Communication Instructions.....	8-184
8.14.1.1	DMC_ReadParameter_CANopen	8-184
8.14.1.2	DMC_WriteParameter_CANopen.....	8-189
8.14.2	Ethernet Instructions	8-193

8.14.2.1	ETH_Link_Config	8-193
8.14.2.2	ETH_Link_Manage	8-198
8.14.2.3	ETH_Link_Status	8-199
8.14.2.4	MODBUS TCP Data Exchange Example	8-202
8.14.2.5	ETH_Link_Config_Ext	8-209
8.14.2.6	ETH_SetServerlinkkeepTime	8-211
8.14.2.7	ETH_Socket_Manage	8-212
8.14.2.8	ETH_Socket_Config	8-214
8.14.2.9	ETH_Socket_Open	8-217
8.14.2.10	ETH_Socket_Send	8-219
8.14.2.11	ETH_Socket_Receive	8-223
8.14.2.12	ETH_Socket_Close	8-227
8.14.2.13	ETH_Socket_Status	8-229
8.14.2.14	Ethernet Free Protocol Example	8-232
8.14.3	RS485 Communication Instructions	8-237
8.14.3.1	RS485_Link_Manage	8-237
8.14.3.2	RS485_Link_Config	8-239
8.14.3.3	RS485_Link_Status	8-243
8.14.3.4	RS485 Data Exchange Example	8-246
8.14.3.5	RS485_RS	8-249
8.14.3.6	RS485 Free Protocol Example	8-255
8.14.3.7	RS485_SetDelayTime	8-259
8.14.4	RS232 Communication Instructions	8-261
8.14.4.1	RS232_Link_Manage	8-261
8.14.4.2	RS232_Link_Config	8-263
8.14.4.3	RS232_Link_Status	8-267
8.14.4.4	RS232 Data Exchange Example	8-270
8.14.4.5	RS232_RS	8-273
8.14.4.6	RS232 Free Protocol Example	8-279
8.14.4.7	RS232_SetDelayTime	8-282
8.15	String Processing Instructions	8-284
8.15.1	CONCAT	8-284
8.15.2	DELETE	8-286
8.15.3	INSERT	8-288
8.15.4	LEFT / RIGHT	8-290

8.15.5	MID	8-292
8.15.6	REPLACE	8-294
8.15.7	LEN	8-296
8.15.8	FIND.....	8-297
8.16	Immediate Refresh Instructions	8-299
8.16.1	FROM.....	8-299
8.16.2	TO	8-303
8.16.3	ImmediateInput	8-307
8.16.4	ImmediateOutput	8-309
8.16.5	Left_Manage.....	8-311
8.17	PID-related Instructions	8-315
8.17.1	PID.....	8-315
8.17.2	GPWM.....	8-326
8.18	Address Instruction	8-328
8.18.1	ADR.....	8-328
8.19	Network Diagnosis	8-330
8.19.1	Motion Diagnosis	8-330
8.19.1.1	CANmotion_SysDiag (Motion System Diagnosis)	8-330
8.19.1.2	CANmotion_NodeDiag (Motion Axis Diagnosis).....	8-332
8.19.2	CANopen Diagnosis.....	8-334
8.19.2.1	CANopen_SysDiag (CANopen System Diagnosis)	8-334
8.19.2.2	CANopen_NodeDiag (CANopen Slave Diagnosis)	8-336
8.19.2.3	CANopen_State (CANopen Master Diagnosis)	8-338
8.20	Read and Write Offset Bit Value	8-340
8.20.1	SetBitOffsetValue	8-340
8.20.2	GetBitOffsetValue	8-342
8.21	FCS Instructions	8-344
8.21.1	CRC	8-344
8.21.2	LRC	8-346

Chapter 9 Introductions of Axis Parameters

9.1	Description of Axis Parameters	9-2
------------	---	------------

Chapter 10 Motion Control Function

10.1	EN and ENO	10-2
10.2	Relation among Velocity, Acceleration and Jerk	10-3
10.3	Introduction of BufferMode	10-6
10.4	The State Machine	10-32

Chapter 11 Motion Control Instructions

11.1	Table of Motion Control Instructions	11-4
11.2	About Motion Control Instructions	11-6
11.2.1	Composition of A Motion Control Instruction	11-6
11.2.2	Program Languages that Motion Control Instructions Support	11-6
11.2.3	Configuration of Motion Control Instructions	11-6
11.3	Single-axis Instructions	11-7
11.3.1	MC_Power	11-7
11.3.2	MC_Home	11-16
11.3.3	MC_MoveVelocity	11-21
11.3.4	MC_Halt	11-28
11.3.5	MC_Stop	11-33
11.3.6	MC_MoveRelative	11-38
11.3.7	MC_MoveAdditive	11-46
11.3.8	MC_MoveAbsolute	11-54
11.3.9	MC_MoveSuperimposed	11-63
11.3.10	MC_HaltSuperimposed	11-70
11.3.11	MC_SetPosition	11-75
11.3.12	MC_SetOverride	11-86
11.3.13	MC_Reset	11-90
11.3.14	DMC_SetTorque	11-93
11.3.15	MC_ReadAxisError	11-98
11.3.16	MC_ReadActualPosition	11-100
11.3.17	MC_ReadStatus	11-105
11.3.18	MC_ReadMotionState	11-110
11.3.19	DMC_ReadParameter_Motion	11-115
11.3.20	DMC_WriteParameter_Motion	11-119
11.3.21	DMC_TouchProbe	11-123
11.3.22	DMC_TouchProbeCyclically	11-131

11.3.23	DMC_Jog	11-135
11.3.24	DMC_MoveVelocityStopByPos	11-137
11.3.25	DMC_MoveVelocityStopByLinePos	11-141
11.3.26	DMC_ReadPositionLagStatus	11-145
11.3.27	DMC_WritePositionLagSetting	11-148
11.3.28	DMC_ChangeMechanismGearRatio	11-150
11.3.29	DMC_TorqueControl	11-152
11.3.30	DMC_MoveVelocity	11-157
11.3.31	DMC_SwitchSoftLimit	11-158
11.4	Multi-axis Instructions	11-160
11.4.1	MC_GearIn	11-160
11.4.2	MC_GearOut	11-166
11.4.3	MC_CombineAxes	11-170
11.4.4	Introduction of Electronic Cam	11-178
11.4.5	MC_CamIn	11-179
11.4.6	MC_CamOut	11-200
11.4.7	DMC_CamReadPoint	11-206
11.4.8	DMC_CamWritePoint	11-210
11.4.9	DMC_CamSet	11-212
11.4.10	DMC_CamReadTappetStatus	11-216
11.4.11	DMC_CamReadTappetValue	11-221
11.4.12	DMC_CamWriteTappetValue	11-224
11.4.13	DMC_CamAddTappet	11-228
11.4.14	DMC_CamDeleteTappet	11-232
11.5	Application Instructions	11-235
11.5.1	Rotary Cut Technology	11-235
11.5.2	Rotary Cut Parameters	11-236
11.5.3	Control Feature of Rotary Cut Function	11-237
11.5.4	Introduction to Cam Curve with Rotary Cut Function	11-238
11.5.5	Rotary-cut Instructions	11-242
11.5.5.1	APF_RotaryCut_Init	11-242
11.5.5.2	APF_RotaryCut_In	11-245
11.5.5.3	APF_RotaryCut_Out	11-247
11.5.6	Application Example of Rotary Cut Instructions	11-249

11.6	G Code Instructions	11-253
11.6.1	CNC Introduction	11-253
11.6.2	G Code Input Format	11-253
11.6.3	Explanation of G Code Formats	11-254
11.6.4	G Code Functions	11-256
11.6.4.1	G90 (Absolute Mode)	11-256
11.6.4.2	G91 (Relative Mode)	11-256
11.6.4.3	G0 (Rapid Positioning)	11-257
11.6.4.4	G1 (Linear Interpolation)	11-260
11.6.4.5	G2 (Clockwise Circular/ Helical Interpolation)	11-264
11.6.4.6	G3 (Anticlockwise Circular /Helical Interpolation)	11-271
11.6.4.7	G17/G18/G19 (Specify Circular Interpolation Plane)	11-277
11.6.4.8	G4 (Dwell Instruction)	11-278
11.6.4.9	G50 (Precise Stop)	11-278
11.6.4.10	G51 (Round path transition)	11-279
11.6.4.11	G52 (Smooth path transition)	11-280
11.6.4.12	M Code	11-281
11.6.5	G Code Instruction	11-284
11.6.5.1	DMC_CartesianCoordinate	11-284
11.6.5.2	DMC_ReadMFunction	11-290
11.6.5.3	DMC_ResetMFunction	11-293
11.6.5.4	DMC_SetG0Para	11-296
11.6.5.5	DMC_SetG1Para	11-299
11.6.5.6	DMC_SetStartPosition	11-302
11.7	Axes Group Instructions	11-305
11.7.1	DMC_AddAxisToGroup	11-305
11.7.2	DMC_RemoveAxisFromGroup	11-307
11.7.3	DMC_UngroupAllAxes	11-309
11.7.4	DMC_GroupEnable	11-311
11.7.5	DMC_GroupStop	11-314
11.7.6	DMC_GroupInterrupt	11-320
11.7.7	DMC_GroupContinue	11-325
11.7.8	DMC_MoveDirectAbsolute	11-327
11.7.9	DMC_MoveDirectRelative	11-332
11.7.10	DMC_MoveLinearAbsolute	11-337

11.7.11	DMC_MoveLinearRelative	11-350
11.7.12	DMC_MoveCircularAbsolute	11-363
11.7.13	DMC_MoveCircularRelative	11-374
11.7.14	DMC_GroupSetOverride	11-385
11.7.15	DMC_GroupReadActualPosition	11-390
11.8	Coordination Instructions	11-392
11.8.1	DMC_ControlAxisByPos	11-392
11.8.2	DMC_NC	11-397
 Chapter12 Troubleshooting		
12.1	Explanation of LED Indicators	12-2
12.2	Table of Error IDs in Motion Instructions	12-8
12.3	System Trouble Diagnosis through System Error Codes	12-12
 Appendix A Modbus Communication		
A.1	Message Format in ASCII Mode	A-2
A.2	Message Format in RTU Mode	A-5
A.3	Modbus Function Codes Supported	A-7
A.4	Modbus Exception Response Code Supported	A-7
A.5	Introduction to Modbus Function Codes	A-8
A.6	Table of Registers and Corresponding Modbus addresses	A-15
 Appendix B Modbus TCP Communication		
B.1	Modbus TCP Message Structure	B-2
B.2	Modbus Function Codes Supported in Modbus TCP	B-2
B.3	Exception Response Code in Modbus TCP	B-3
B.4	Modbus Function Codes in Modbus TCP	B-3
B.5	Registers and Corresponding Modbus Addresses	B-12
 Appendix C CANopen Protocol		
C.1	Node States	C-4

C.2	Network Management (NMT)	C-6
C.3	PDO (Process Data Object)	C-6
C.4	SDO (Service Data Object)	C-8

Appendix D Explanation of Homing Modes

D.1	Explanation of Homing Modes	D-2
------------	--	------------

Appendix E List of Accessories

E.1	Accessories for CANopen Communication	E-2
E.2	Accessories for PROFIBUS DP Communication	E-4
E.3	Accessories for DeviceNet Communication	E-4

Caution

- This manual provides an introduction to product functions, specifications, installation, basic operations and settings.
- This product is an OPEN TYPE device and therefore should be installed in an enclosure free of airborne dust, humidity, electric shock and vibration. The enclosure should prevent non-maintenance staff from operating the device (e.g. key or specific tools are required for operating the enclosure) in case that danger and damage on the device may occur.
- Be sure to read the manual carefully and follow the instructions herein so as to avoid injuries to personnel and damage to products.

Chapter 1 Preface

Table of Contents

1.1	Explanation of Symbols in This Manual.....	1-2
1.2	Revision History	1-3

1

Thank you for purchasing DVP-15MC series motion controller which is created on the basis of motion control and we are providing you with a high-end motion control system.



This manual describes the product specifications, functions, system architecture, installation, wiring, execution principle, logic instructions and motion control instructions, trouble-shooting, communication protocols, homing modes and other relevant information.

Make sure that you have well known about the motion control system configuration and product operation before using DVP-15MC series motion controller.

1.1 Explanation of Symbols in This Manual

- **Precautions before operation**

Before operation, please read relevant safety instructions carefully so as to prevent an injury to personnel and damage to products.

 Danger	It indicates the highly potential hazards. It is possible to cause a severe injury or even fatal harm to personnel if you do not follow the instructions.
 Warning	It indicates the potential hazards. It is possible to cause a minor injury or even fatal harm to personnel if you do not follow the instructions.
 Caution	It indicates much attention should be paid. An unexpected result may occur if you do not follow the instructions.

1.2 Revision History

DVP-15MC series operation manual revision history:

Version	Revision	Release Date
1 st	The first version was published.	Jun. 15, 2018
2 nd	<ol style="list-style-type: none"> 1. The contents about DVP15MC11T-06 is added. 2. Function that Ethernet Communication port Supports in Section 6.7.1 is added. 3. Communication instructions in Section 8.14 are added. 4. PID-related instructions in Section 8.17 are added. 5. Network Diagnosis instructions in Section 8.19 are added. 6. Read and Write Offset Bit Value instructions in Section 8.20 are added. 7. FCS instructions in Section 8.21 are added. 8. The instructions with the name starting with DMC in Section 11.3 are added. 9. G code instructions in Section 11.6 are added. 10. Axes group instructions in Section 11.7 are added. 11. Coordination instructions in Section 11.8 are added. 12. Communication instructions in section 8.14 are added. 13. The contents about error IDs in motion instructions in Section 12.2 are modified and added. 14. The contents about system error codes in Section 12.3 are modified and added. 	Jan. 13 2020

MEMO

1

Chapter 2 Overview

Table of Contents

2.1	Product Description.....	2-2
2.2	Functions.....	2-2
2.3	Profile and Components	2-3

2.1 Product Description

DVP-15MC series motion controllers are multi-axis motion controllers researched and produced by Delta autonomously on the basis of CANopen field bus. It complies with CANopen DS301 basic communication protocol and DSP402 motion control protocol. In addition, it also supports standard instruction libraries defined by international organizations for motion control. It brings great convenience to user to learn and develop projects quickly. Multiple axes can be controlled by means of Motion port. The single-axis motion instructions including velocity, position, torque and homing instructions as well as multi-axis instructions such as electronic gear, electronic cam, rotary cut and G code are supported.

Multiple communication ports are built in DVP-15MC series motion controller. And thus various communication functions can be realized without adding modules. DVP-15MC series motion controller has left-side and right-side extension ports for adding DVP-S series modules to its left and right sides. (The left-side port is a high-speed parallel extension port.)

The communication system adopts highly reliable CAN bus as the main line and hence users just need simple cables for wiring.

Thanks to the high-speed reliable motion control system, DVP-15MC-series controller can be widely applied to a variety of automation control industries such as packaging, printing, encapsulating, wire cutting, drug manufacturing and so on.

DVP-15MC series motion controllers include DVP15MC11T and DVP15MC11T-06. For the two models, the max. numbers of axes they controlled are different. Their specifications such as peripheral communication ports, left-side and right-side extension and program capacity are the same.

2.2 Functions

- DVP15MC11T can control up to 24 real axes (with axis No. ranging from 1 to 32).
- DVP15MC11T-06 can control up to 6 real axes (with axis No. ranging from 1 to 16).
- The virtual axis and encoder axis can be built inside DVP15MC11T (with the axis No. ranging from 1 to 32, which can not be the same as that of real axes).
- The virtual axis and encoder axis can be built inside DVP15MC11T-06 (with the axis No. ranging from 1 to 16, which can not be the same as that of real axes).
- Equipped with 1GHz high-speed floating-point operation processor; supporting 64-bit floating point (Lreal) and capable to meet various complicated motion control.
- With two built-in incremental encoder ports and one SSI absolute encoder port.
- With one RS232 port, one RS485 port and two Ethernet ports.
- With one built-in CAN port serving as CANopen master or slave.
- Supports powerful field network (as Profibus-DP slave) for construction of a function-complicated control system.
- With a variety of I/O extensions (Left-side high-speed AIAO; right-side low-speed AIAO and DIDO and temperature modules).
- Using the easy-to-use software interface with the features of complete function and convenient application.
- Providing standard bus cables, terminal resistors, distributor boxes and other accessories as well as easy and convenient plug-and-play wiring.

2.3 Profile and Components

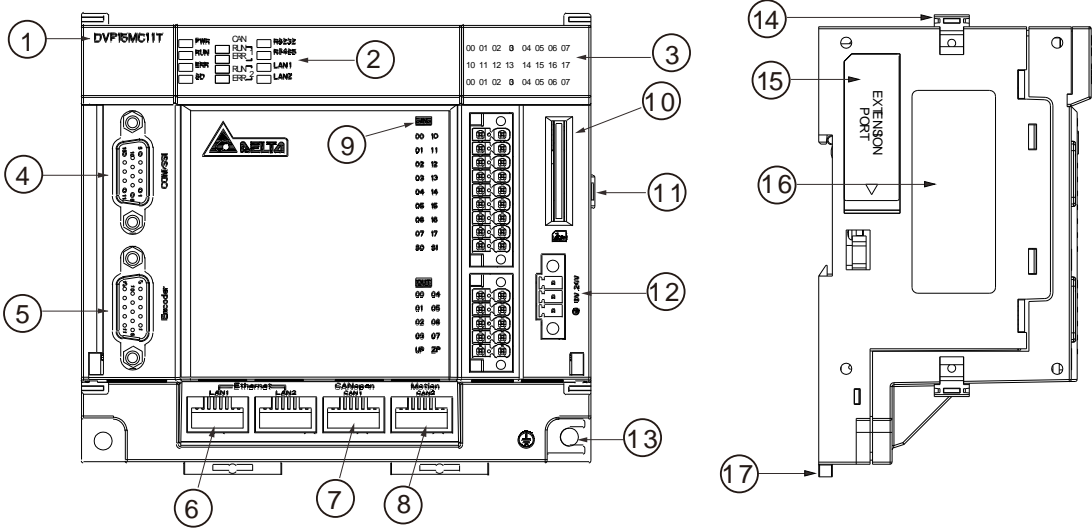

①	Model name	⑩	SD card slot
②	State indicators	⑪	Right-side extension module port
③	IO indicators	⑫	24V power port
④	COM/SSI communication port	⑬	Screw fixing clip
⑤	Incremental encoder port	⑭	Extension module fixing clip
⑥	Ethernet communication port	⑮	Left-side extension module port
⑦	CANopen communication port	⑯	Nameplate
⑧	CANmotion communication port	⑰	DIN rail fixing clip
⑨	Input and output pins and symbols		

MEMO

2

Chapter 3 Specifications

Table of Contents

3.1 Functional Specifications	3-2
3.1.1 Specifications	3-2
3.1.2 Devices and Data Types	3-3
3.1.2.1 Devices	3-3
3.1.2.2 Valid Ranges of Devices	3-4
3.1.2.3 Latched Devices	3-5
3.1.2.4 Data Types and Valid Ranges Supported	3-5
3.2 Electrical Specifications	3-6

3.1 Functional Specifications

3.1.1 Specifications

Item				Specification			
Programming	Program capacity	Size		20M			
		Quantity	Number of POU definitions	1024			
	Memory capacity for variables	Retained	Size	128K			
		Non-retained	Size	20M			
	G code	One single G code program	Size	256K			
		G code programs	Quantity	64			
Motion control	Number of controlled axes	Max. number of axes for single-axis control	Model name	No. of real axes	No. of virtual axes	No. of real axes & virtual axes	
			DVP15MC11T	24	32	32	
			DVP15MC11T-06	6	16	16	
		Max. number of axes for linear interpolation	8				
		Max. number of axes for circular interpolation	3				
	Number of cams	Size	Quantity	64			
Cam key points	Key points of one single cam	Quantity	2048				
Built-in ports of DVP-15MC series controller	CAN	2	One CAN port supports the standard CANopen protocol and the other CAN port is used in Motion.				
	Ethernet	2	Two independent Ethernet ports				
	RS-232	1	Used as a master or slave				
	RS-485	1	Used as a master or slave				
	Incremental encoder	2	Builds an encoder axis. Z signal can trigger an interrupt program.				
	SSI absolute encoder	1	Builds an encoder axis				
	Input points	Quantity	16 points (External interrupt trigger is supported.)				
	Output points	Quantity	8 points				
	Left-side extension port	1	DVP-S series left-side extension module				
	Right-side extension port	1	DVP-S series special module				

Item				Specification
Left-side and right-side extension	Left-side extension	Left-side extension modules	Quantity	8 pieces of DVP-S series left-side extension modules
	Right-side extension	Special modules	Quantity	8 pieces of DVP-S series special modules
		Digital modules	Number of points	240 input points and 240 output points

3.1.2 Devices and Data Types

3.1.2.1 Devices

- Device Name Explanation

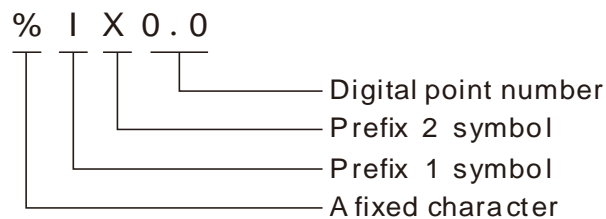

- Relevant Devices of DVP-15MC Series Motion Controller Used in the Software

No.	Item	Content				
1	Prefix 1 symbol	I	Q	M		
2	Prefix 1 name	Input device	Output device	Intermediate device		
3	Prefix 2 symbol	X	B	W	D	L
4	Data type of prefix 2	BIT	BYTE	WORD	DWORD	QWORD
5	Device example	%IX0.0	%IB0	%IW0	%ID0	%IL0
6		%QX0.0	%QB0	%QW0	%QD0	%QL0
7		%MX0.0	%MB0	%MW0	%MD0	%ML0

- The Corresponding Relationships of Devices

%ML0 includes %MB0~%MB7, %MD0 includes %MB0~%MB3 and %MW0 includes %MB0~%MB1 as shown in the following table.

Device name	Corresponding relationships																																							
	The 1 st WORD					The 2 nd WORD					The 3 rd WORD					The 4 th WORD																								
	Bit 0	...	Bit 7	Bit 8	...	Bit 15	Bit 0	...	Bit 7	Bit 8	...	Bit 15	Bit 0	...	Bit 7	Bit 8	...	Bit 15	Bit 0	...	Bit 7	Bit 8	...	Bit 15																
%MX	%MX0.0~0.7					%MX1.0~1.7					%MX2.0~2.7					%MX3.0~3.7					%MX4.0~4.7					%MX5.0~5.7					%MX6.0~6.7					%MX7.0~7.7				
%MB	%MB0					%MB1					%MB2					%MB3					%MB4					%MB5					%MB6					%MB7				
%MW	%MW0					%MW1					%MW2					%MW3																								
%MD	%MD0										%MD1																													
%ML	%ML0																																							

%ML1 includes %MB8~%MB15, %MD2 includes %MB8~%MB11, %MW4 includes %MB8~%MB9 and %MB8 includes %MX8.0~8.7 as shown in the following table.

Device name	Corresponding relationships																																							
	The 5 th WORD					The 6 th WORD					The 7 th WORD					The 8 th WORD																								
	Bit 0	...	Bit 7	Bit 8	...	Bit 15	Bit 0	...	Bit 7	Bit 8	...	Bit 15	Bit 0	...	Bit 7	Bit 8	...	Bit 15	Bit 0	...	Bit 7	Bit 8	...	Bit 15																
%MX	%MX8.0~8.7					%MX9.0~9.7					%MX10.0~10.7					%MX11.0~11.7					%MX12.0~12.7					%MX13.0~13.7					%MX14.0~14.7					%MX15.0~15.7				
%MB	%MB8					%MB9					%MB10					%MB11					%MB12					%MB13					%MB14					%MB15				
%MW	%MW4					%MW5					%MW6					%MW7																								
%MD	%MD2										%MD3																													
%ML	%ML1																																							

3.1.2.2 Valid Ranges of Devices

- The table of valid ranges of the devices in DVP-15MC series motion controller

Device name	Expression	Range
%IX	%IX0.0~%IX0.7	%IX0.0~%IX127.7
%QX	%QX0.0~%QX0.7	%QX0.0~%QX127.7
%MX	%MX0.0	%MX0.0~%MX131071.7
%IB	%IB0	%IB0~%IB127
%QB	%QB0	%QB0~%QB127
%MB	%MB0	%MB0~%MB131071
%IW	%IW0	%IW0~%IW63
%QW	%QW0	%QW0~%QW63
%MW	%MW0	%MW0~%MW65535
%ID	%ID0	%ID0~%ID31
%QD	%QD0	%QD0~%QD31
%MD	%MD0	%MD0~%MD32767
%IL	%IL0	%IL0~%IL15
%QL	%QL0	%QL0~%QL15
%ML	%ML0	%ML0~%ML16383

- The table of Modbus device addresses

The Modbus addresses which are within the range of 16#0000~16#FFFF can be accessed via the standard MODBUS function code 01, 02, 03, 05, 06, 16#0F and 16#10. When a MODBUS function code is used to access bit devices, please access QX and IX bit devices. If MX bit devices need be accessed, the MW device is accessed and then the values in the MX bit devices can be got through the MW device.

See Section 3.1.2.1 for details on the corresponding relationship between MW and MX devices.

Device area	Device type	Range	Modbus address	Modbus address type
I (Input)	Bit	%IX0.0~%IX0.7	16#6000~16#6007	Standard Modbus address
		%IX1.0~%IX1.7	16#6008~16#600F	
		
		%IX127.0~%IX127.7	16#63F8~16#63FF	
	Word	%IW0~%IW63	16#8000~16#803F	

Device area	Device type	Range	Modbus address	Modbus address type
Q (Output)	Bit	%QX0.0~%QX0.7	16#A000~16#A007	
		%QX1.0~%QX1.7	16#A008~16#A00F	
		
	%QX127.0~%QX127.7	16#A3F8~16#A3FF		
	Word	%QW0~%QW63	16#A000~16#A03F	
M (Register)	Word	%MW0~%MW32767	16#0000~16#7FFF	

3.1.2.3 Latched Devices

The %MW0~%MW999 devices are latched devices in which data are retained when power off. Besides, the variables defined in the software can select Retain as its property. The capacity of latched devices is 128K bytes.

3.1.2.4 Data Types and Valid Ranges Supported

The data types and valid ranges of the variables in the software that DVP-15MC series motion controller uses are shown in the following table.

No.	Data type	Valid range	Initial value
1	BOOL	TRUE or FALSE	FALSE
2	BYTE	16#00 ~ FF	16#00
3	WORD	16#0000 ~ FFFF	16#0000
4	DWORD	16#00000000 ~ FFFFFFFF	16#00000000
5	LWORD	16#0000000000000000 ~ FFFFFFFFFFFFFFFF	16#0000000000000000
6	USINT	0 ~ +255	0
7	UINT	0 ~ +65535	0
8	UDINT	0 ~ +4294967295	0
9	ULINT	0 ~ +18446744073709551615	0
10	SINT	-128 ~ +127	0
11	INT	-32768 ~ +32767	0
12	DINT	-2147483648 ~ +2147483647	0
13	LINT	-9223372036854775808 ~ +9223372036854775807	0
14	REAL	-3.402823e+38 ~ -1.175495e-38, 0, +1.175495e-38 ~ +3.402823e+38	0.0
15	LREAL	-1.79769313486231e+308 ~ -2.22507385850721e-308, 0, +2.22507385850721e-308 ~ +1.79769313486231e+308,	0.0
16	TIME	T#XXXXXXdXXhXXmXXsXXXms · Unit: ns. Range:T#0ms~213503d23h34m33s709.551ms	T#0ms
17	DATE	D#Y-M-D. Range: D#1970-01-01~D#2106-02-07. Unit: s.	D#1970-01-01
18	TOD	TOD#H:M:S:MS, Range:TOD#00:00:00~23:59:59.999. Unit: ms. If 0 is written, TOD#00:00:00 is displayed. If 1 is written, TOD#00:00:00.001 is displayed. If 86399999 is written, TOD#23:59:59.999 is displayed. If 86400000 is written, TOD#00:00:00 is displayed. If 4294967295 is written, TOD#17:2:47.295 is displayed.	TOD#00:00:00
19	DT	DT#Y-M-D-H-M-S. Range: DT#1970-01-01-0:0:0~2106-02-07-6:28:15. Unit: s.	DT#1970-01-01-0:0:0
20	STRING	0~32000 characters	“

3.2 Electrical Specifications

- Electrical specification

Item	Content
Power voltage	24 VDC (-15% ~ +20%)
Fuse capacity	3 A/30 VDC, Polyswitch
Isolation voltage	500 VDC (Secondary-PE)
Consumption power	8W Max
Vibration/shock immunity	Standard: IEC61131-2, IEC 68-2-6 (TEST Fc) / IEC61131-2 & IEC 68-2-27 (TEST Ea)
Interference immunity	Static electricity: 8KV Air Discharge, 4KV Contact Discharge EFT: Power Line: ± 2 KV, Digital Input: ± 1 KV, Communication I/O: ± 1 KV RS: 80MHz ~ 1000MHz, 10V/m. Conducted Susceptibility Test: 150kHz ~ 80MHz, 3V/m Surge Test: Power line 0.5KV DM/CM
Environment	Work: 0°C ~ 55°C (Temperature), 5 ~ 95% (Humidity), pollution level 2 Storage: -25°C ~ 70°C (Temperature), 5 ~ 95% (Humidity).
Weight	About 425g

- Electrical specification for input points

Item	Content
Number of input channels	16 channels
Channel type	High-speed digital input type for the 16 channels
Input terminals	Terminal I0~I7 · I10~I17
Common terminal for input points	Terminal S0/S1
Input type	Sink or Source mode
Input delay	2.5 μ S (OFF -> ON) , 5 μ S (ON -> OFF)
Input current	24 VDC, 5mA
Max. cable length	The shielded cable: 500m ; The unshielded cable: 300m

- Electrical specification for output points

Item	Content
Number of output channels	8 transistors for output (N-MOS)
Channel type	High-speed digital output type for 8 channels
Output terminals	Terminal Q0~Q7
Common terminal for output points	Terminal UP/ZP (Used for connection of anode or cathode of supply power)
Power voltage for output points	24 VDC (-15% ~ +20%) #1
Output delay	2 μ S (OFF -> ON) , 3 μ S (ON -> OFF)
Max. switch frequency	1KHZ

Item	Content
Max. loading	Resistance: 0.5A/1point (2A/ZP)
	Inductance: 13W (24VDC)
	Bulb: 2.5W (24VDC)
Max. cable length	The shielded cable: 500m
	The unshielded cable: 300m

#1: UP and ZP must connect the auxiliary power 24VDC (-15%~20%).

MEMO

Chapter 4 System Architecture

Table of Contents

4.1 System Constitution	4-2
4.2 Power Supply.....	4-2
4.3 Left-side Extension.....	4-2
4.3.1 Connectable Left-side Extension Module.....	4-2
4.3.2 Allocation of Left-side Network Module Addresses.....	4-3
4.3.3 Method of Reading/Writing of Left-side Modules	4-3
4.4 Right-side Extension.....	4-3
4.4.1 Connectable Right-side Extension Modules	4-3
4.4.2 Allocation of Right-side Extension Module Addresses.....	4-4
4.5 Connectable Servo Drives	4-5
4.6 SD Memory Card	4-7
4.6.1 Model and Specification	4-7

4.1 System Constitution

A multi-layer industrial network can be built by means of the motion controller. By using the motion controller, the network can consist of top-layer Ethernet, middle-layer CANopen and Profibus bus as well as bottom-layer RS-485 bus which supports Modbus as follows.

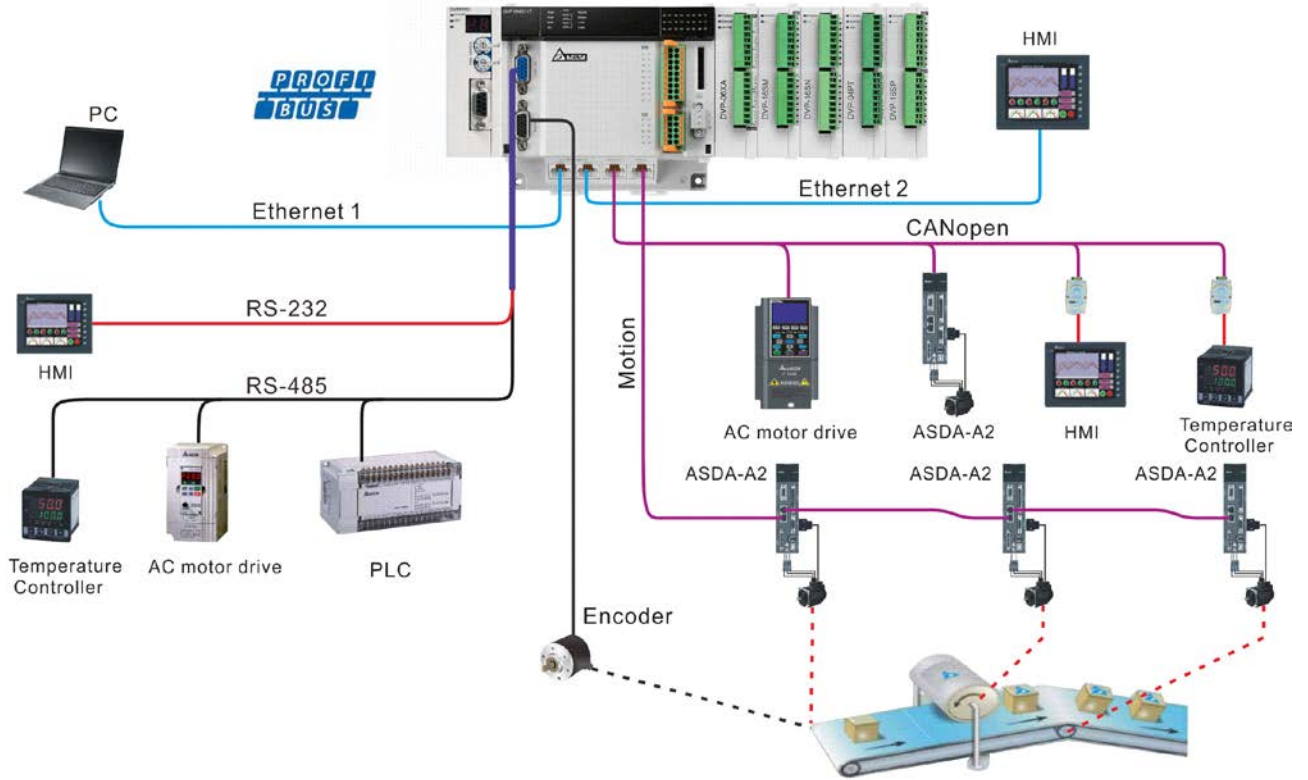

The figure above illustrates the peripheral devices which are connected to various ports of the motion controller in the entire system. Refer to chapter 6 for details on the functions of communication ports.

4.2 Power Supply

Delta power modules are recommended as the power supply for the motion controller. The information of Delta power modules is shown in the following table.

No.	Module name	Phase	Input voltage	Output voltage	Power	Output current	International Standard
1	DVPPS02	Single phase	85~264VAC	24VDC	48W	2A	
2	DVPPS05				120W	5A	

4.3 Left-side Extension

4.3.1 Connectable Left-side Extension Module

Max. 8 high-speed extension modules can be connected to the left side of the motion controller and the connectable modules are listed in the following table.

No.	Module name	Module type	Description
1	DVP04AD-SL	Analog module	Analog input

No.	Module name	Module type	Description
2	DVP04DA-SL	Analog module	Analog output
3	DVPPF02-SL	Network module	Profibus communication

4.3.2 Allocation of Left-side Network Module Addresses

- **About Input and Output Mapping Areas of Left-side Network Modules**

The input and output mapping areas of different positions of the left side of PLC CPU are listed as follows when the network modules connected to the left side of the motion controller serve as a slave. The position 1 is for the first module connected to the left side of PLC CPU; the position 2 is for the second one connected to the left side of PLC CPU and so on.

Mapping area Position	Output mapping area	Input mapping area
1	%MW6250~%MW6377	%MW6000~%MW6127
2	%MW6750~%MW6877	%MW6500~%MW6627
3	%MW7250~%MW7377	%MW7000~%MW7127
4	%MW7750~%MW7877	%MW7500~%MW7627
5	%MW8250~%MW8377	%MW8000~%MW8127
6	%MW8750~%MW8877	%MW8500~%MW8627
7	%MW9250~%MW9377	%MW9000~%MW9127
8	%MW9750~%MW9877	%MW9500~%MW9627

Refer to the operation manuals of modules for details on allocation of left-side extension module mapping areas. Pay attention to how the mapping address expression format is changed in the operation manual.

For example, the output mapping area for DVPPF02-SL is D6250~D6349. But the area address is expressed as %MW6250~%MW6349 when the module is connected to the left of the motion controller.

4.3.3 Method of Reading/Writing of Left-side Modules

The controller can read and write the data in CR registers of the left-side extension modules via FROM/TO instruction. For instance, the modules such as DVP04AD-SL and DVP04DA-SL may use FROM/TO to read and write data in CR.

4.4 Right-side Extension

4.4.1 Connectable Right-side Extension Modules

DVP-S series extension modules including digital modules, analog modules and temperature modules can be connected to the right side of the motion controller. Digital modules can connect maximum 240 input points and 240 output points. Maximum 8 analog modules can be connected. The connectable right-side extension modules are listed in the following table.

No.	Module name	Input data length	Output data length	Extension type
1	DVP08SM11N	8 bits	-	Input point extension
2	DVP16SM11N	16 bits	-	
3	DVP06SN11R	-	6 bits	Output point extension

No.	Module name	Input data length	Output data length	Extension type
4	DVP08SN11R/T	-	8 bits	Input extension and output extension
5	DVP16SN11T	-	16 bits	
6	DVP08SP11R/T	4 bits	4 bits	
7	DVP16SP11R/T	8 bits	8 bits	
8	DVP16SP11TS (PNP)	8 bits	8 bits	
9	DVP32SM11N	32 bits	-	Pin-connector input
10	DVP32SN11TN	-	32 bits	Pin-connector output
11	DVP08ST11N	8 bits	-	Digital switch
12	DVP04AD-S	4 words	-	Analog input
13	DVP06AD-S	6 words	-	
14	DVP04DA-S	-	4 words	Analog output
15	DVP02DA-S	-	2 words	
16	DVP06XA-S	4 words	2 words	Analog input and analog output
17	DVP04PT-S	4 words	-	Sensor (Model: PT100)
18	DVP06PT-S	6 words	-	
19	DVP04TC-S	4 words	-	Sensor (Model: J, K, R, S, T thermocouples)
20	DVP01PU-S	-	-	Pulse output Three modes using the differential output way: Pulse/Dir, FP (CW)/RP (CCW), A/B

4.4.2 Allocation of Right-side Extension Module Addresses

The motion controller can connect DVP-S series extension modules to its right side and max. 240 digital input points and 240 digital output points are connectable. Max. 8 special modules are connectable such as analog modules, temperature modules and pulse modules. Up to 14 digital modules and special modules at most are connectable to the right side of the motion controller.

- **Digital point numbers of right-side digital extension modules**

1. The digital point number of the digital extension modules on the right of the motion controller starts from 2.0. For example, the input point for the first digital module starts from %IX2.0 and the output point starts from %QX2.0. It is counted as 8 points if the number is less than 8.
2. Digital input points and output points are numbered in decimal system as below.
%IX2.0 ~ %IX2.7,....., %IX8.0 ~ %IX8.7,....., %IX31.0 ~ %IX31.7
%QX2.0 ~ %QX2.7,....., %QX8.0 ~ %QX8.7,....., %QX31.0 ~ %QX31.7

- **About the right-side special module and serial number**

1. The right-side extension modules such as analog modules, temperature modules and pulse modules are regarded as special modules.
2. The serial number of the first special module to the right side of the motion controller is 0; the serial number of the second one is 1, and so on. Maximum 8 special modules can be connected. The start address for input of the right-side special module is %MW10000 and the start address for output of the right-side special module is %MW10500.

4.5 Connectable Servo Drives

There are many models for ASDA-A2, ASDA-B3 and ASDA-A3-series servo drives. ASDA-A2-XXXX-M, ASDA-A2-XXXX-MN, ASDA-B3-XXXX-M and ASDA-A3-XXXX-M models support CANopen communication. Only these models of servo drives can be used to build CANopen motion control network through the connection to the Motion port of the motion controller.

- **Illustration of the servo drive model**

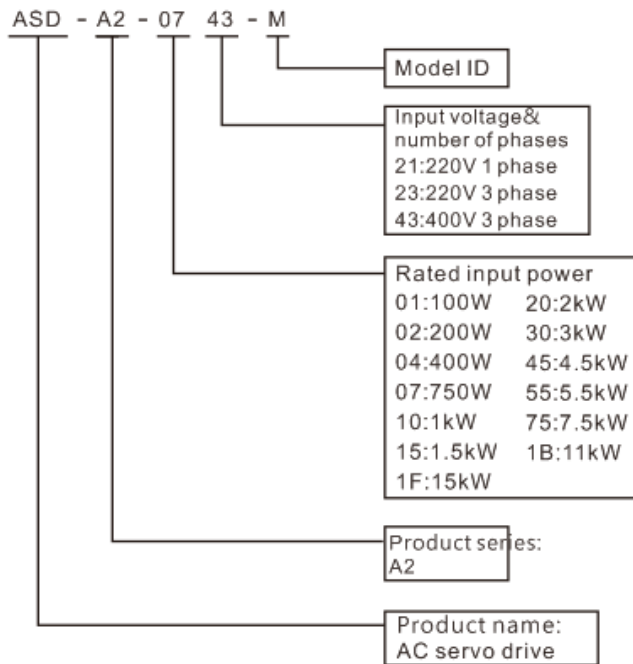

- **Relevant servo parameter settings are shown in the following table when the motion controller and the servo drive are connected.**

Parameter	Explanation	Setting value	Explanation
P1-01	Setting the control mode of the servo	X0B*1	Set as CANopen mode
P3-00	Setting a node ID	Setting range: 1~24	The setting of this parameter corresponds to the node address of the servo in the CANopen network
P3-01	Baud rate	0403	The baud rate that the parameter value corresponds to must be consistent with that of the motion controller. 0403: CANopen baud rate is 1Mbps 0203: CANopen baud rate is 500Kbps

*1 : The output directions of the torque are illustrated as below when the value of X is 0 and 1 respectively.

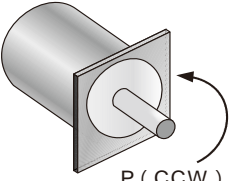
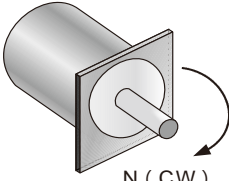
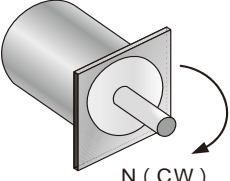
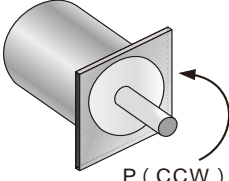
	0	1
Positive direction	 P (CCW)	 N (CW)
Negative direction	 N (CW)	 P (CCW)

● The wiring figure of the motion controller and ASDA-A2-XXXX-M-series servo drives
DVP15MC11T

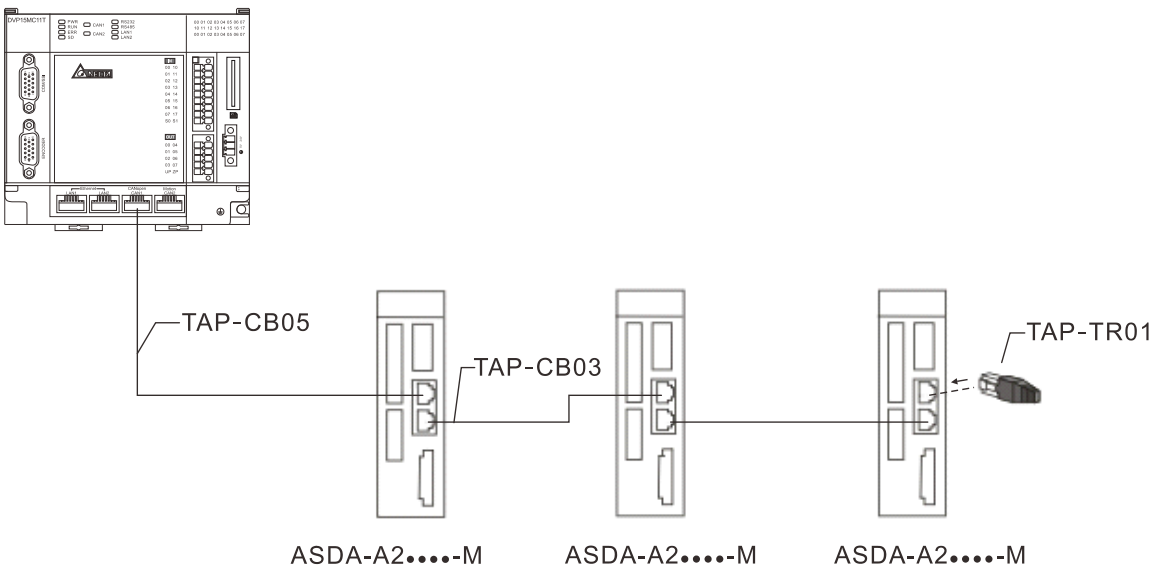

Notes:

1. Please refer to the servo user manual for the wiring of ASDA-A2-XXXX-M-series servo drives, servo motors and encoders.
2. Choose UC-CMC003-01A or UC-CMC005-01A or UC-CMC010-01A communication cable according to the field status.
3. There is one 120Ω terminal resistor embedded at Motion port. In the CANopen network consisting of Motion port and servos, the other end of the network must be connected with a terminal resistor TAP-TR01 which could be found in the packing box of the motion controller.

4.6 SD Memory Card

4.6.1 Model and Specification

- **Model and Appearance**

SD memory cards can be classified into SD, Mini SD and Micro SD according to its size. The motion controller only supports the first type of SD as below.

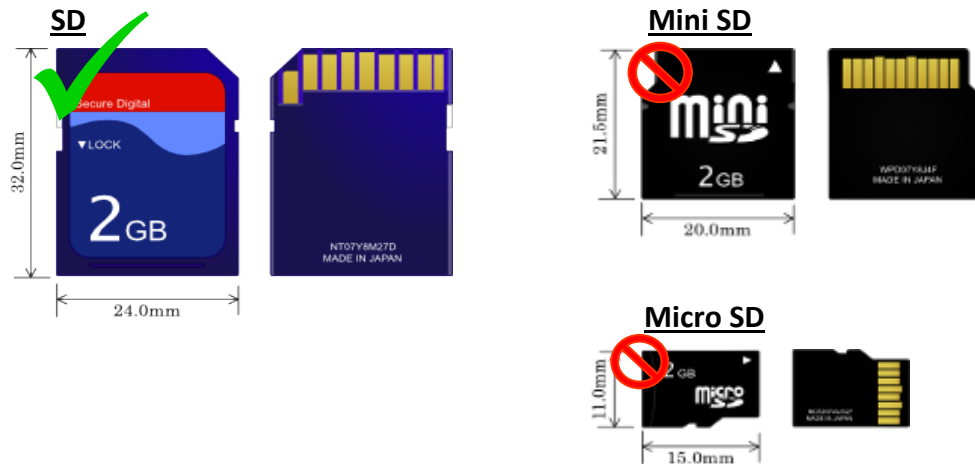

- **Specification**

There are various SD card specifications on current market. Except that SD cards are different in size, they can be classified into SD, SDHC and SDXC according to its capacity. However, controllers only supports basic SD specification currently. The following table includes the information of SD card family members. Controllers only supports SD and SDHC. Please make sure to purchase the SD card of the right specification that the controller supports.

- **SD card classification**

Class	SD	SDHC			SDXC	
Capacity	32MB~2GB	4GB~32GB			32GB~2TB	
File system	FAT16/FAT32	FAT32			exFAT (FAT64)	
Size	SD	SDHC	Mini SDHC	Micro SDHC	SDXC	Micro SDXC
SD speed level	N/A	CLASS 2 (Min. 2MB/Sec.) CLASS 4 (Min. 4MB/Sec.) CLASS 6 (Min. 6MB/Sec.) CLASS 10 (Min. 10MB/Sec.)			CLASS 2 (Min. 2MB/Sec.) CLASS 4 (Min. 4MB/Sec.) CLASS 6 (Min. 6MB/Sec.) CLASS 10 (Min. 10MB/Sec.)	

* Please notice that there is a kind of MMC card which is very similar to SD card in appearance and thus please differentiate them carefully during purchase.

- **Before use of SD card**

- **Write-protection function of the memory card**

There is a write-protection switch for general SD cards. The data can not be written into SD card if the switch is moved to the Lock position. Hence, please ensure that the write-protection switch of SD card has been released correctly before SD card is used and then the write-into function can be executed in motion controllers.

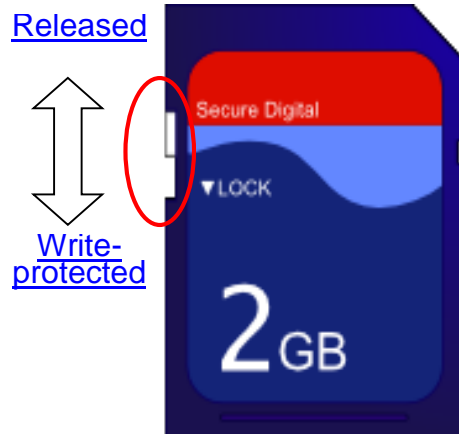

Chapter 5 Installation

Table of Contents

5.1 Dimensions	5-2
5.1.1 Profile and Dimensions	5-2
5.1.2 Dimensions of Left-side and Right-side Extension Modules	5-2
5.1.3 Connecting to the Left-side Extension Module.....	5-3
5.1.4 Connecting to the Right-side Extension Module.....	5-5
5.1.5 Installing and Removing the SD Card	5-6
5.2 Installing the Module in the Control Cabinet	5-8
5.2.1 Installing the Module to DIN rail	5-8
5.2.2 Illustration of Installation Inside the Control Cabinet	5-8
5.2.3 Environmental Temperature in the Control Cabinet.....	5-9
5.2.4 Actions for Anti-interference.....	5-9
5.2.5 Dimension Requirement in the Control Cabinet	5-10

5.1 Dimensions

5.1.1 Profile and Dimensions

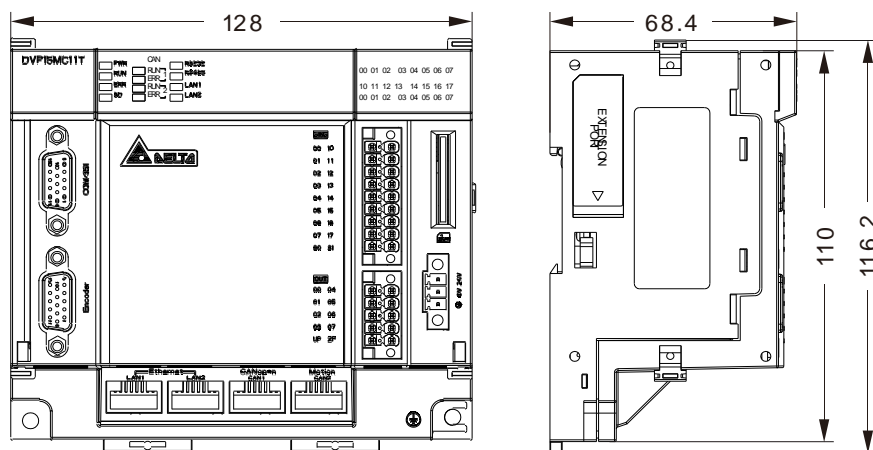

Unit: mm

5.1.2 Dimensions of Left-side and Right-side Extension Modules

- See the following dimension figure of a left-side extension module by taking DVPCOPM-SL for example. The length, width and height of all left-side modules are the same as that of DVPCOPM-SL.

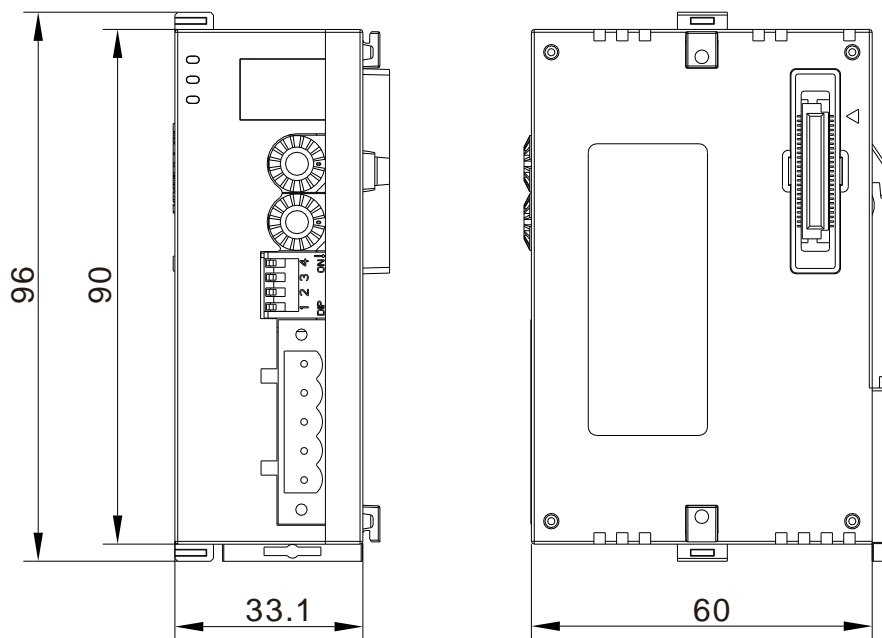

Unit: mm

- See the following dimension figure of a right-side extension module, which takes DVP04AD-S for example. The length, width and height of all left-side modules are the same as that of DVP04AD-S.

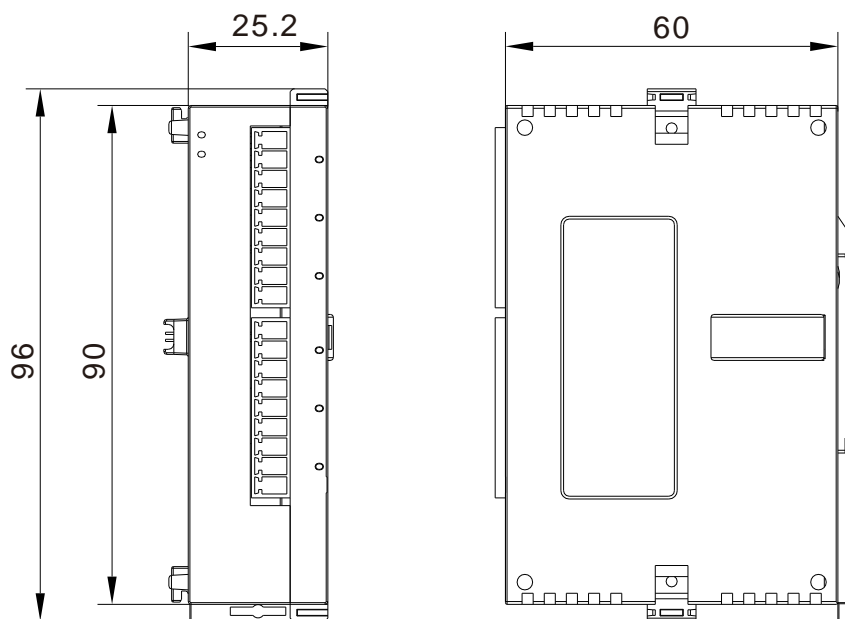

Unit: mm

5.1.3 Connecting to the Left-side Extension Module

- Connection of DVP-15MC series motion controller and DVPDNET-SL
 - Pull open the extension module clips on the top left and bottom left of DVP-15MC series motion controller and install DVPDNET-SL along four mounting holes in the four angles of DVP-15MC series motion controller as step 1 in figure 5.1.3.1.
 - Press the clips respectively on the top left and bottom left of DVP-15MC series motion controller to fix the module tightly and ensure that their contact is normal as step 2 in figure 5.1.3.1.

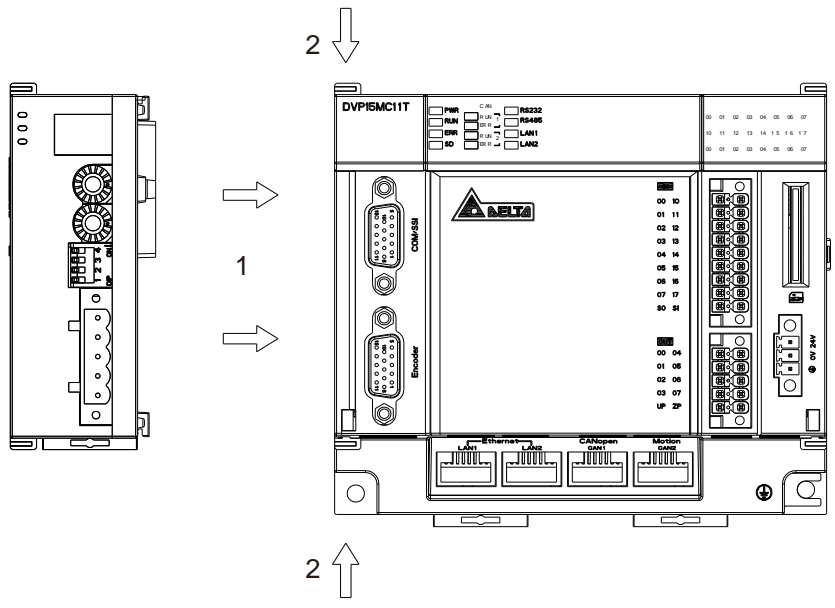

Figure 5.1.3.1

- Installing DVP-15MC series motion controller and DVPDNET-SL into DIN rail
 - Use standard 35mm DIN rail.
 - Pull open DIN rail clips of DVP-15MC series motion controller and DVPDNET-SL and then insert the two modules into DIN rail.
 - Press the DIN rail clips into DVP-15MC series motion controller and DVPDNET-SL to fix the two modules in DIN rail as figure 5.1.3.2.

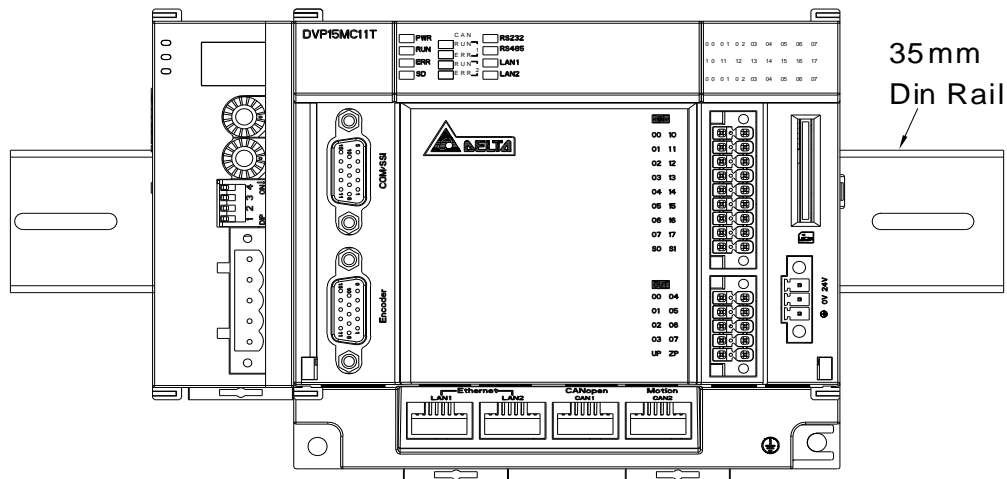

Figure 5.1.3.2

5.1.4 Connecting to the Right-side Extension Module

- Connection of DVP-15MC series motion controller and DVP16SP11T
 - Pull open the extension module clips on the top right and bottom right of DVP-15MC series motion controller and install DVP16SP11T along four mounting holes in the four angles of DVP-15MC series motion controller as step 1 in figure 5.1.4.1.
 - Press the clips on the upper right and bottom right of DVP-15MC series motion controller to fix the module tightly and ensure that their contact is normal as step 2 in figure 5.1.4.1

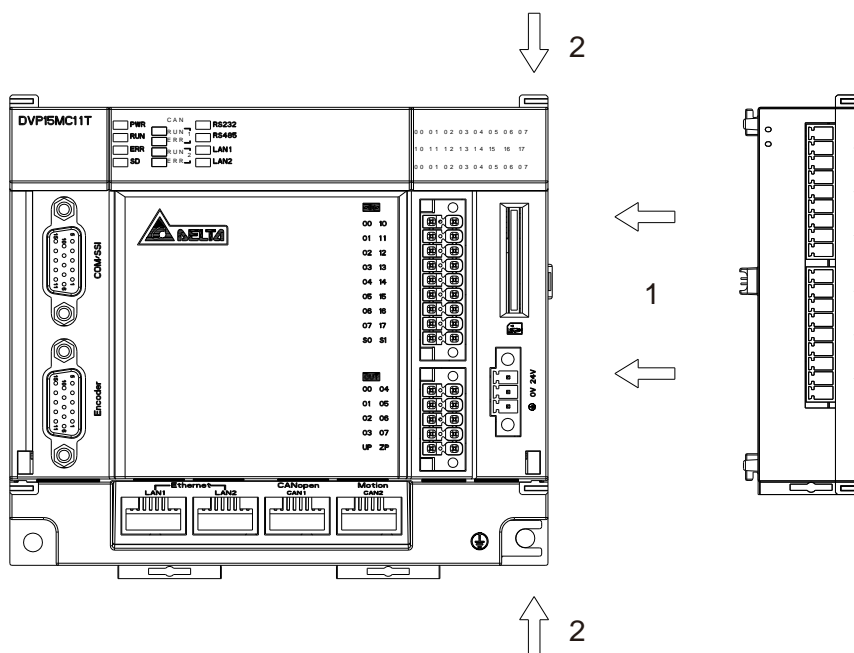

Figure 5.1.4.1

- Installing DVP-15MC series motion controller and DVP16SP11T in DIN Rail
 - Use standard 35mm DIN rail.
 - Pull open DIN rail clips of DVP-15MC series motion controller and DVP16SP11T and then insert the two modules into DIN rail.
 - Press the DIN rail clips into DVP-15MC series motion controller and DVP16SP11T to fix the two modules in DIN rail as figure 5.1.4.2.

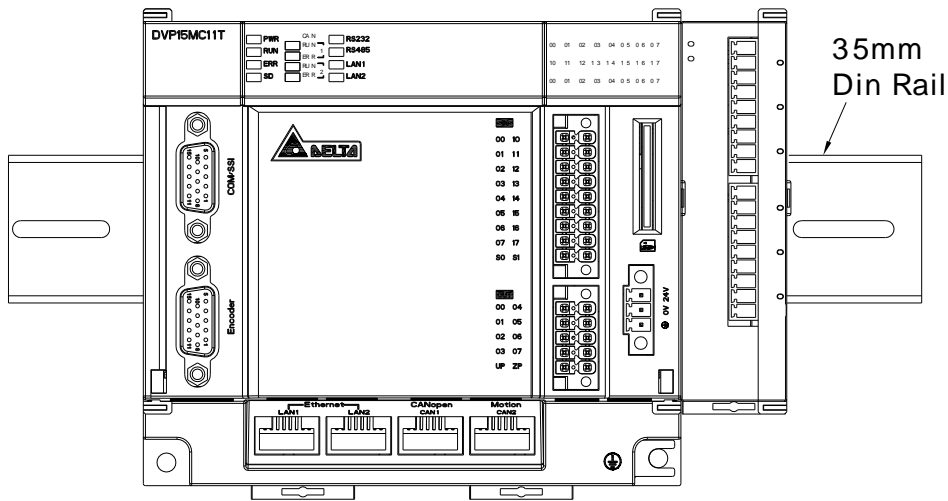
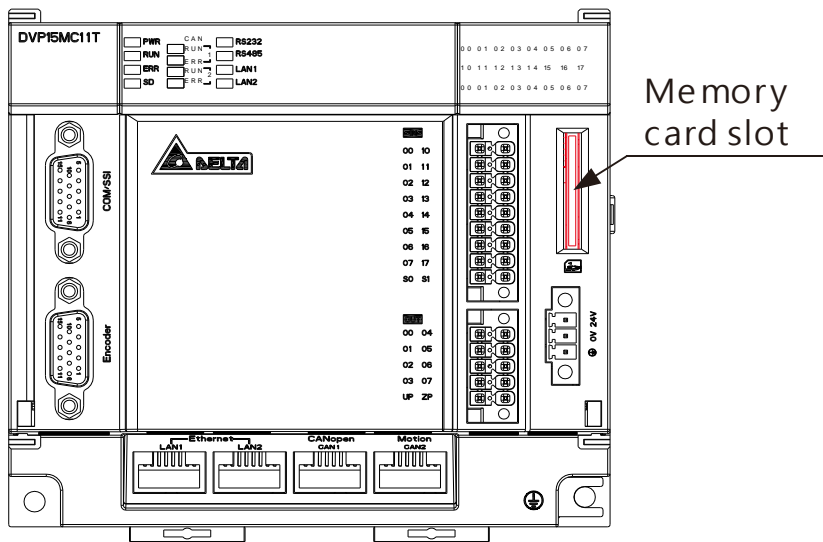

Figure 5.1.4.2

5.1.5 Installing and Removing the SD Card

- The memory card slot of DVP-15MC series motion controller

The memory card slot is seated in the right side of the front of DVP-15MC series motion controller as illustrated below.



- Installing SD card

Insert an SD card to the memory card slot directly and push it to the end of the slot until hearing a click. After the installation is finished, the SD card should be fixed tightly. If the SD card inserted to the slot is loose, the installation is unsuccessful. In addition, the SD card has a fool-proofing design. If the direction in which SD card is inserted is wrong, the card will fail to reach the end of the slot. In this case, do not force to push the SD card toward the end of the slot in order to avoid the damage to the module and SD card.

Follow the instructions in the figures below to insert the SD card in the right direction.

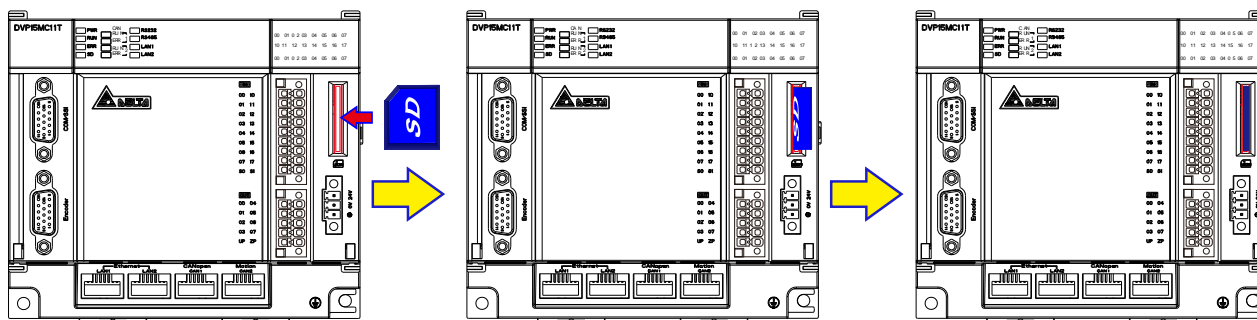

- Removing SD card

Just push the SD card to the end of the slot so that the SD card will loosen and rebound from inside the slot. And then remove the SD card out of the slot easily.

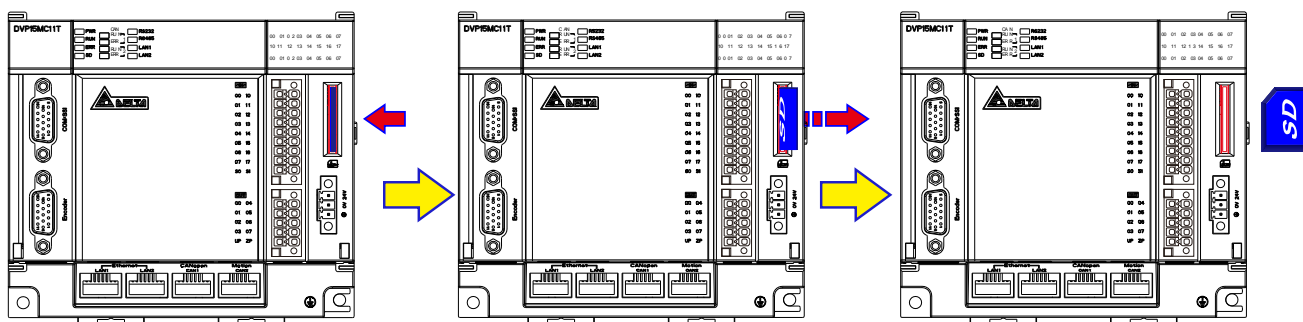

5.2 Installing the Module in the Control Cabinet

5.2.1 Installing the Module to DIN rail

Pull out the clips at the rear of the motion controller. Then stick the horizontal slots at the rear of the module on the DIN rail. Finally, push in the clips to fix the module inside the control cabinet.

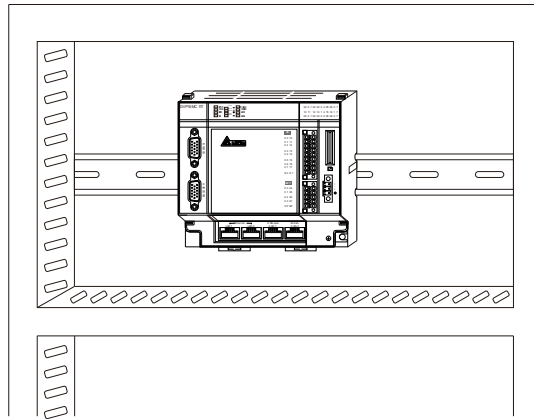

5.2.2 Illustration of Installation Inside the Control Cabinet

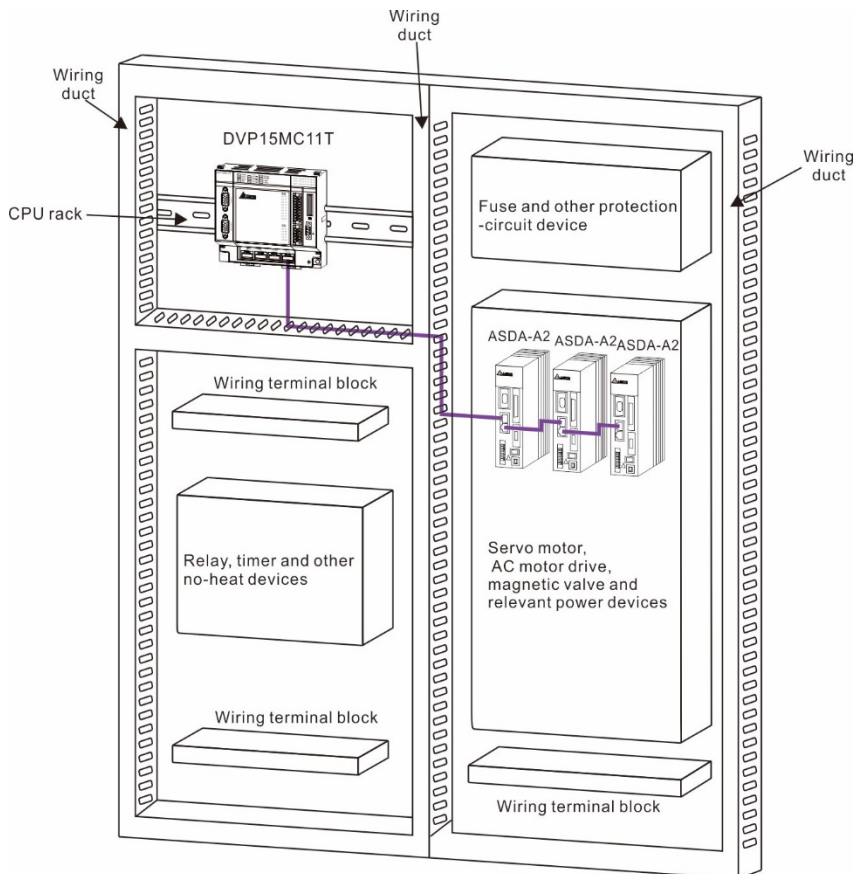

5.2.3 Environmental Temperature in the Control Cabinet

- Requirements

 **Warning**

- The ambient temperature of the motion controller inside the control cabinet is 0~55°C and the humidity is 5 ~ 95%.
- Please avoid making the installation near the high-temperature equipment.
- Keep enough space for air ventilation.
- The fan or air conditioner must be installed if the environment temperature exceeds 55°C.
- The motion controller is for indoor use only.
- The control cabinet which is 1.0m~2.0m in height is easier for installation and operation.
- Keep the installation away from the high-voltage equipment and power equipment.
- The power supply in the control cabinet must be cut off before installation.

5.2.4 Actions for Anti-interference

 **Warning**

- Do not install the controller in the control cabinet which contains high-voltage equipment.
- Please keep at least 200mm far away from the power wire for the installation.
- There should be a grounding wire for the control cabinet.
- If the equipment is used in a manner not specified by the manufacturer, the protection provided by the equipment may be impaired.

5.2.5 Dimension Requirement in the Control Cabinet

- **Installation Figure**

DVP-15MC series motion controller has to be installed in an enclosure. In order to ensure that the controller radiates heat normally, the space between the controller and the enclosure has to be larger than 50 millimeters. $D > 50\text{mm}$

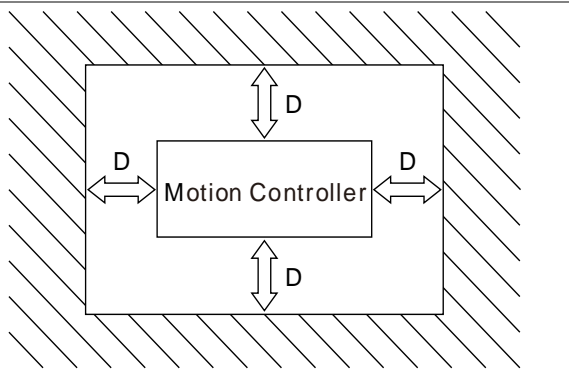

Chapter 6 Wiring, Communication Setting and Network Construction

Table of Contents

6.1	Wiring	6-3
6.1.1	Power Supply	6-3
6.1.2	Safety Circuit Wiring.....	6-4
6.2	Input Point and Output Point Wiring	6-6
6.2.1	Function that Input Points Support	6-6
6.2.2	Input Point Wiring	6-7
6.2.3	Output Point Wiring	6-9
6.3	RS-485 Communication Port	6-10
6.3.1	Function that RS-485 Port Supports	6-10
6.3.2	Definitions of RS-485 Port Pins	6-10
6.3.3	RS-485 Hardware Connection	6-10
6.3.4	Supported Function Codes and Exception Codes.....	6-11
6.4	RS-232 Communication Port	6-13
6.4.1	Function that RS-232 Port Supports	6-13
6.4.2	Definitions of RS-232 Port Pins	6-13
6.4.3	RS-232 Hardware Connection	6-13
6.4.4	Supported Function Codes and Exception Codes.....	6-14
6.5	SSI Absolute Encoder Port	6-15
6.5.1	Function of SSI Absolute Encoder.....	6-15
6.5.2	Definitions of SSI Port Pins.....	6-15
6.5.3	SSI Absolute Encoder Hardware Connection	6-16
6.6	Incremental Encoders	6-17
6.6.1	Function of Incremental Encoder	6-17
6.6.2	Definition of Incremental Encoder Port Pins	6-17
6.6.3	Incremental Encoder Hardware Connection	6-18
6.7	Ethernet Communication Port	6-19
6.7.1	Function that Ethernet Communication Port Supports	6-19
6.7.2	Pins of Ethernet Communication Port	6-20
6.7.3	Network Connection of Ethernet Communication Port	6-20
6.7.4	Function Codes that Ethernet Communication Port Supports....	6-20

6.8	Motion Communication Port	6-22
6.8.1	Function that Motion Communication Port Supports	6-22
6.8.2	Pins of Motion Communication Port	6-22
6.8.3	Motion Network Connection.....	6-22
6.8.4	Communication Speed and Communication Distance.....	6-22
6.9	CANopen Communication Port	6-23
6.9.1	Functions that CANopen Communication Port Supports.....	6-23
6.9.2	Pins of CANopen Communication Port.....	6-24
6.9.3	PDO Mapping at CANopen Communication Port.....	6-24
6.9.4	Network Connection at CANopen Communication Port	6-24
6.9.5	CANopen Communication Rate and Communication Distance ..	6-25

6.1 Wiring

6.1.1 Power Supply

The power input of the motion controller is 24V DC. Please notice the following points during use.

Warning

- Connect the supply power to the two terminals, 24V and 0V and the grounding terminal to the earth. Be cautious that the motion controller may be damaged if the positive and negative polarities of the supply power are connected reversely.
- Please be sure to use certified power supply with SELV output or certified power supply providing double insulation evaluated by UL60950, or UL61010-1 and UL61010-2-201 standards
- Use copper conductors as power wires only. The diameter of power wires must be between 12 and 28AWG and the rated temperature should be greater than 70°C. The power terminal block plug wiring torque is 4.5 in-lbs.
- Separate the supply power for the controller, the external supply power for input and output points of the controller and the supply power for other loads. The controller uses an individual supply power.
- Add a noise filter and an isolation transformer before the controller's supply power. The isolation transformer is installed between the supply power and the noise filter. The transformer secondary side need not be earthed. See the wiring diagram below.
- The isolation transformer effectively reduces interference from the ground, electrical surge noise and etc. The power wires between the isolation transformer and the controller should be tightly twisted. The shorter the distance between them is, the better effect is produced. Be sure to keep away from the power lines and high voltage lines.
- The noise filter can effectively reduce interference. The incoming cable and the outgoing cable of the filter should be arranged separately to avoid coupling the interference before the noise filter to the cable after the noise filter.
- The long power shutdown or power voltage drop will stop the motion controller from running and the controller will stop communicating with the servo drive when all outputs are FALSE. The motion controller will resume the connection with the servo drive when the power supply returns to normal.

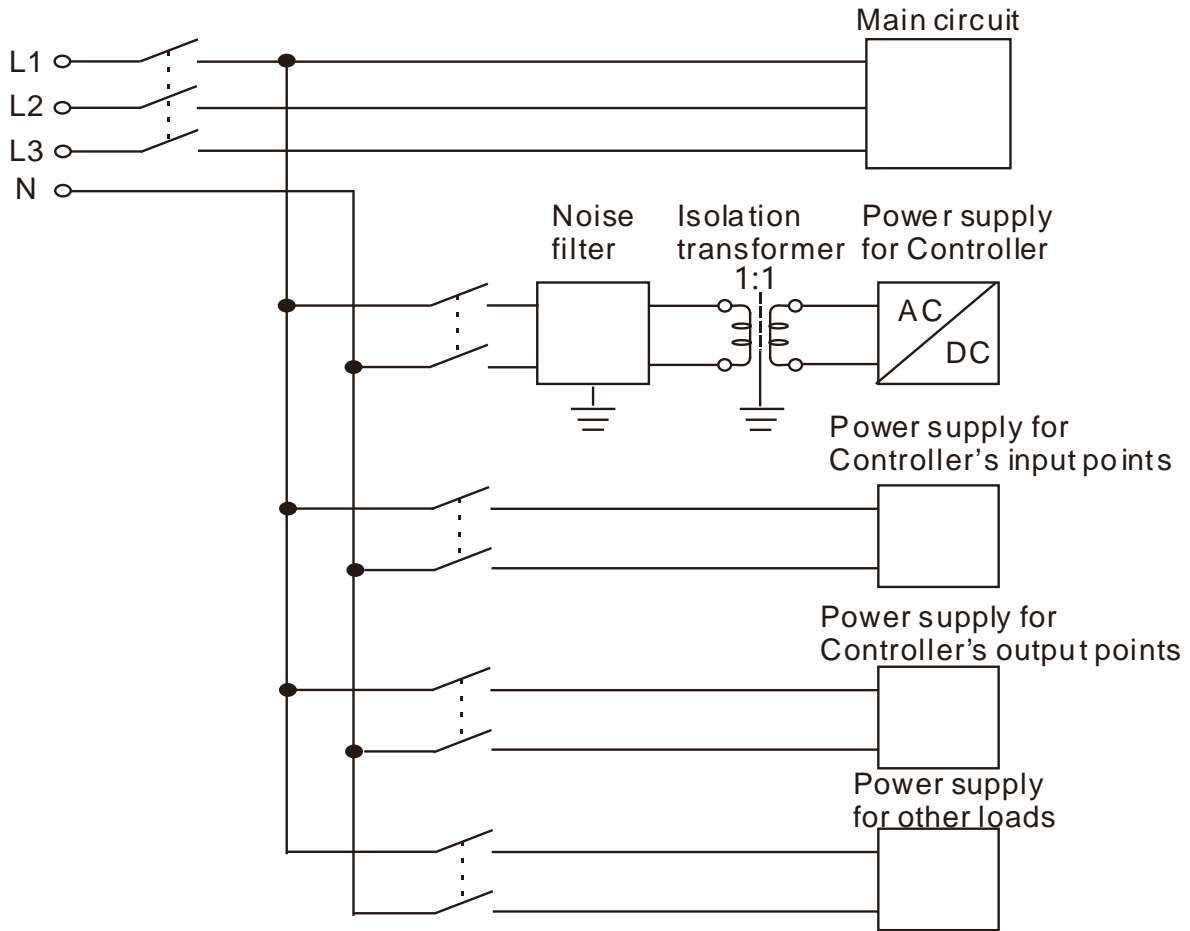

6

6.1.2 Safety Circuit Wiring

⚠ Warning

The action of any device inside the motion controller may affect the behavior of the external equipment under the motion controller's control over the servo drive. Therefore, any device trouble may cause the entire automatic control system to lose control and even result in injuries and death of personnel. For these reasons, we suggest the following safety device should be included in the power input circuit.

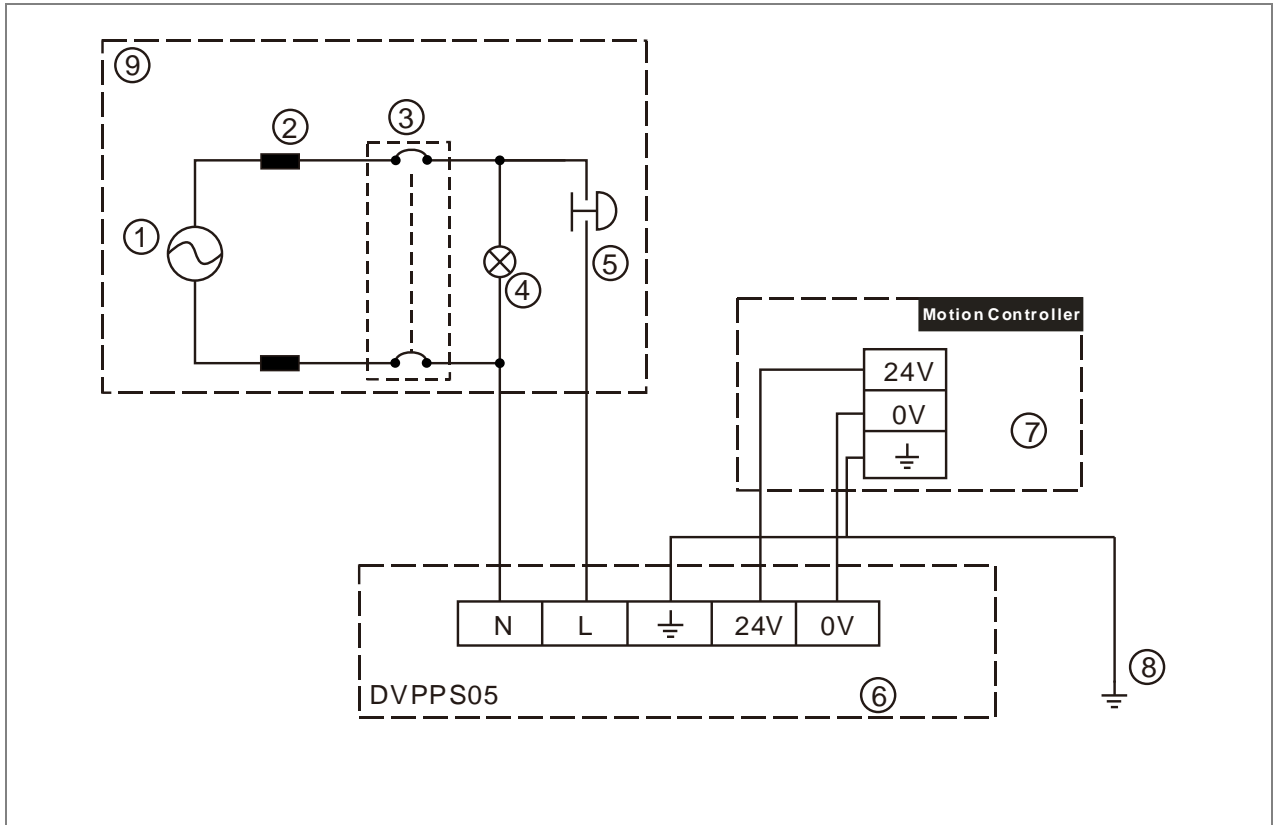

- ① AC power supply: 100~240VAC; 50/60Hz.
- ② Power supply circuit protection fuse
- ③ System circuit isolation device: The electromagnetic contactor, relay and other switch can be used as the isolation device to prevent the system from becoming unstable when the power supply is discontinuous.
- ④ Power indicator
- ⑤ Emergency stop button: The button cuts off the system power supply when an accidental emergency takes place.
- ⑥ Delta power module DVPPS05/24VDC (DVPPS05 is recommended for the motion controller)
- ⑦ The motion controller
- ⑧ Ground
- ⑨ Safety circuit

6.2 Input Point and Output Point Wiring

6.2.1 Function that Input Points Support

There are 16 input points which support external interrupt and filter functions in the motion controller. In addition, the input points can be used to capture the encoder position.

Refer to the explanation of the DMC_TouchProbe instruction for details on position capture.

- **The work principle of the input filter**

The input filter filters short pulse signals via the 16 I points I0~I7 and I10~I17 to reduce the influence of the input interference signals. Increasing the filter value can decrease the vibration of input signals or the influence from external interference.

Input filter time: $t=31\mu s * (0\sim 255)$. So the filter time is a multiple of 31 μs and 0 is the default value.

The input filter time can be set through the software.

- ◆ **When there is the set filter:**

When the filter time is set to t (μs), the signal is valid if the ON or OFF time of the input signal is greater than t (μs). If the ON or OFF time of input signal is less than t (μs), the signal will be eliminated. The input signal left after being filtered will be input after being delayed by t (μs).

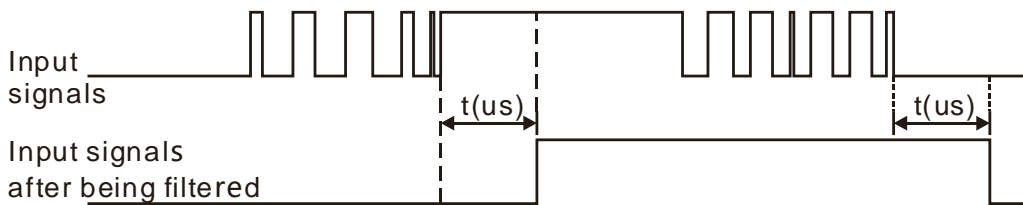

Figure 6.2.1.1

- ◆ **When there is no filter set:**

The input signals have no change when no filter time is set.

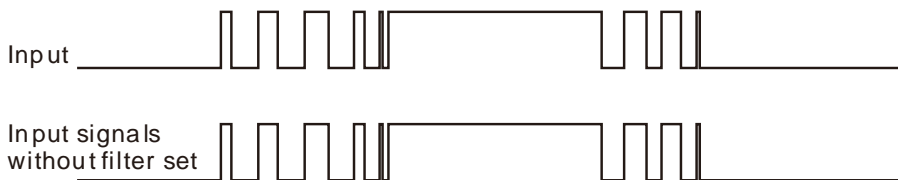

Figure 6.2.1.2

6.2.2 Input Point Wiring

There are two types of DC inputs, SINK and SOURCE. See the details for the wiring in the following two modes.

- **Sink Mode**

Under Sink mode, the simplified model is shown below and the current flows into the common ports S0 and S1.

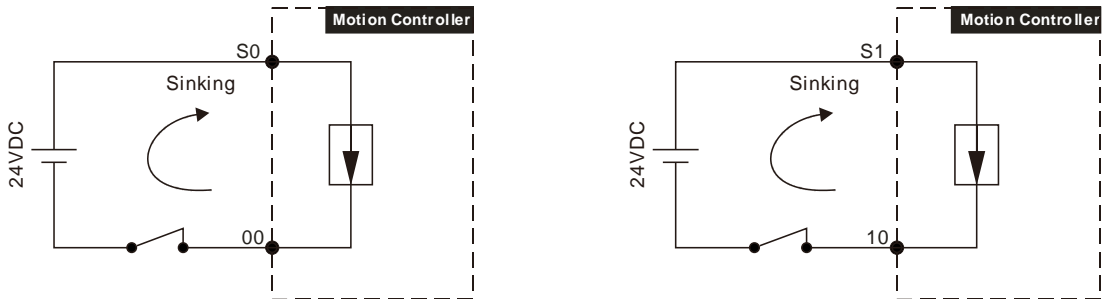

Figure 6.2.2.1

See the relevant wiring circuit in the following figures.

- The input points of the motion controller, 00~07 correspond to S0 as shown below.

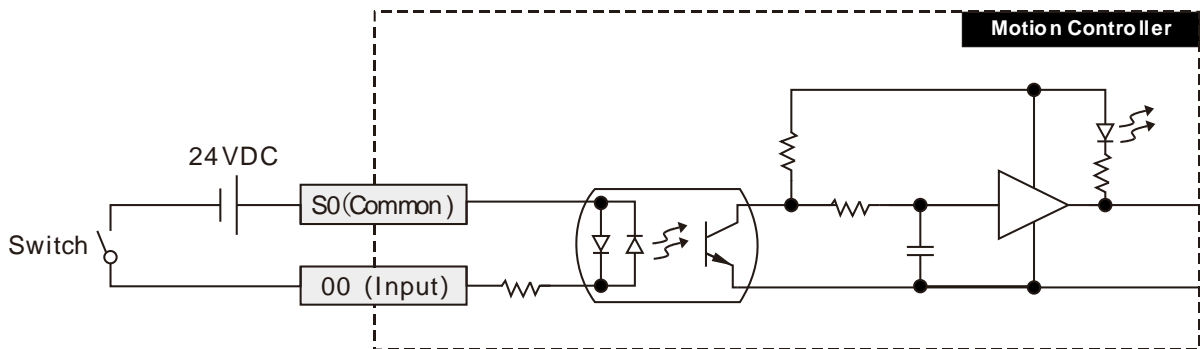

Figure 6.2.2.2

- The input points of the motion controller, 10~17 correspond to S1 as shown below.

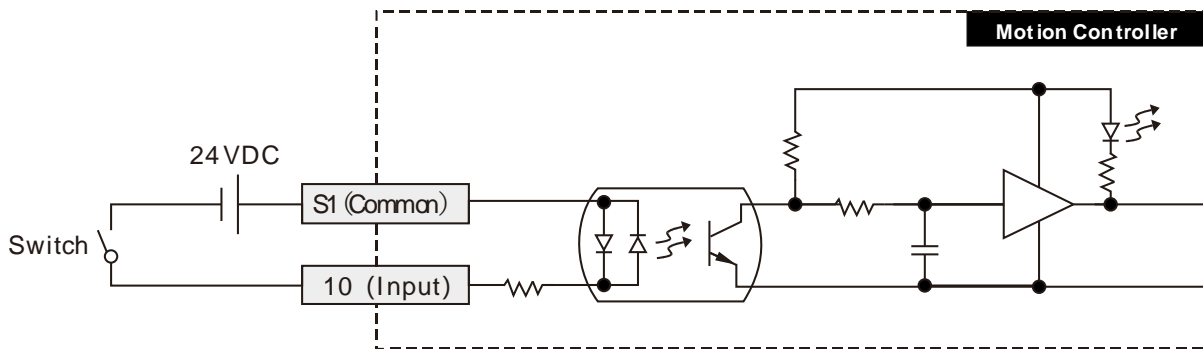

Figure 6.2.2.3

● **Source Mode**

Under Source mode, the simplified model is illustrated below and the current flows into the common ports S0 and S1.

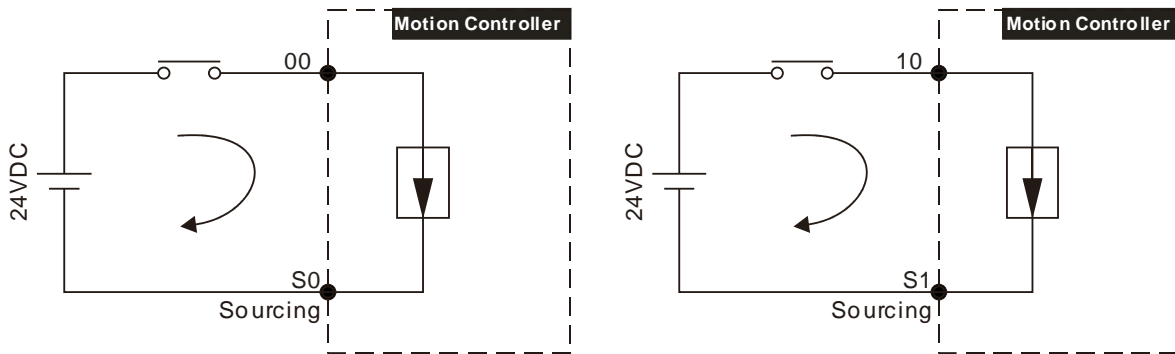

Figure 6.2.2.4

See the wiring circuit below.

- The input points of the motion controller, 00-07 correspond to S0 as shown below.

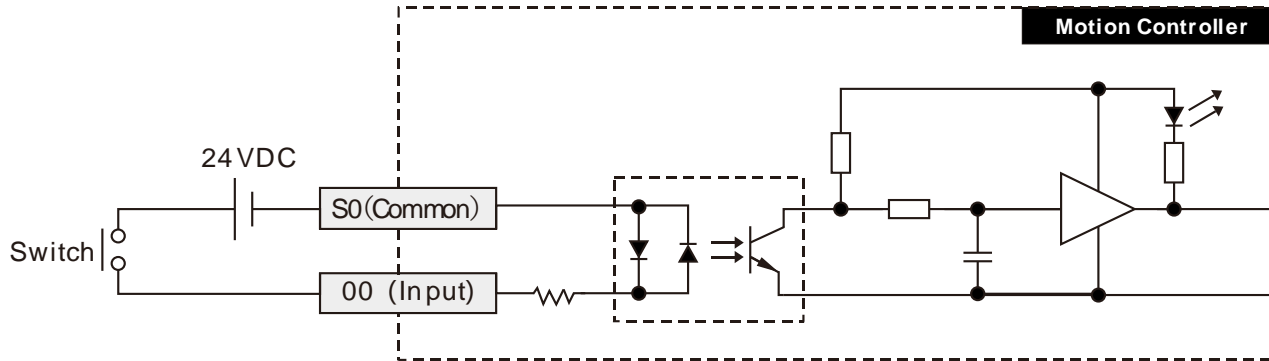

Figure 6.2.2.5

- The input points of the motion controller, 10-17 correspond to S1 as shown below.

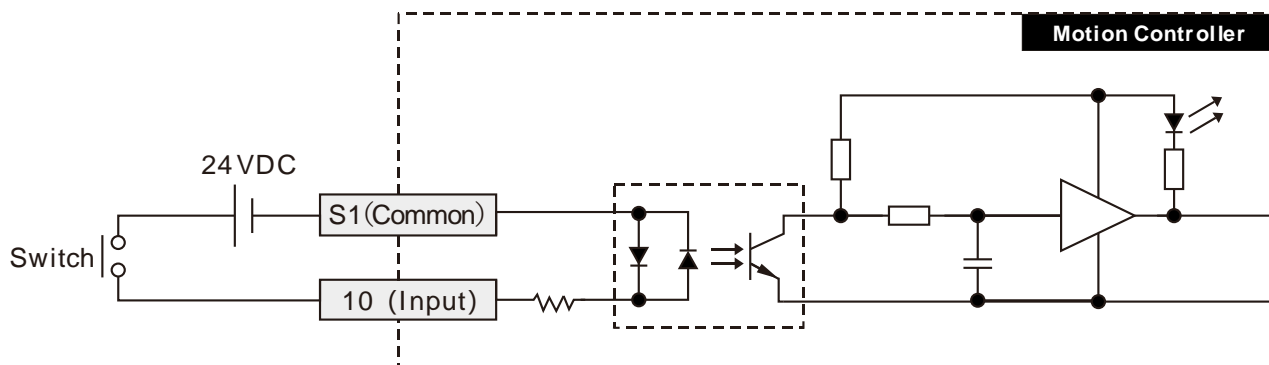
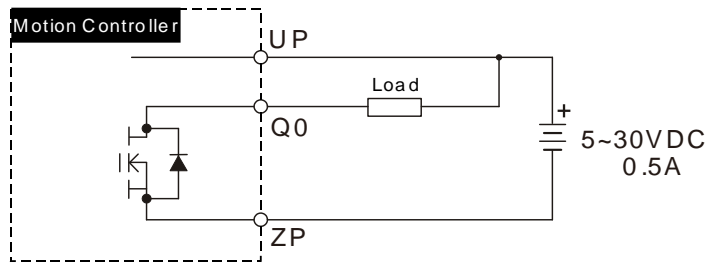

Figure 6.2.2.6

6.2.3 Output Point Wiring

All local output points of the motion controller are of transistor output. The wiring circuit is shown as below.



6.3 RS-485 Communication Port

6.3.1 Function that RS-485 Port Supports

The RS-485 communication port of the motion controller can function as Modbus master or slave. HMI, PLC or other Modbus master device can read and write data in the devices inside the motion controller. The interval time when the Modbus master accesses the motion controller should exceed 5ms.

The program can not be downloaded via RS-485 port. RS-485 supports Modbus protocol, ASCII as well as RTU mode. The function codes which RS-485 port supports include 16#01, 16#02, 16#03, 16#05, 16#06, 16#0F and 16#10. The station addresses that RS-485 port supports are 1~255. The broadcast function is not supported.

Refer to appendix A for details on Modbus communication and Modbus device addresses.

6.3.2 Definitions of RS-485 Port Pins

The motion controller’s COM/SSI port consists of 15 pins. The external port is commonly used for RS-485 communication and SSI absolute encoder. See the table below for definitions of respective RS-485 communication port pins.

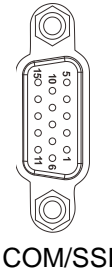
Pin No.	Signal	Definition	
11	D+	Positive pole	
12	D-	Negative pole	
5	SG	Signal ground	COM/SSI

6.3.3 RS-485 Hardware Connection

- Example on Connection of DVP-15MC Series Motion Controller into Modbus Network

The controller is connected to Modbus network via RS-485.

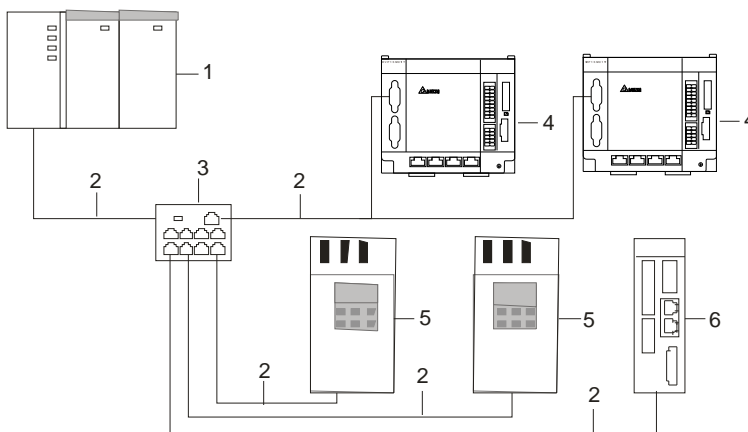

Device No.	1	2	3	4	5	6
Device name	Modbus master	Communication cable	VFD-CM08	The motion controller	AC motor drive	Servo drive

● **RS-485 Wiring:**

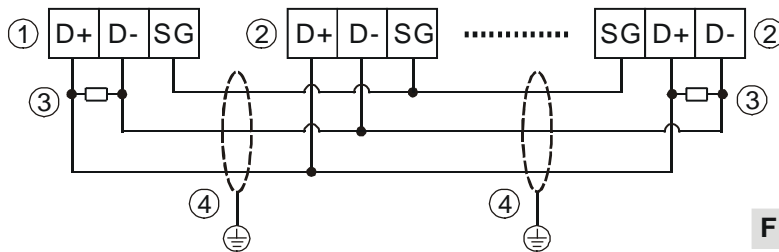

Figure 19

Explanation of numbers

①	②	③	④
Master	Slave	Terminal resistor	Shielded cable

Notes:

1. Terminal resistors with the value of 120Ω are recommended to connect to both ends of the bus.
2. To ensure high communication quality, please use the shielded twisted pair cable (20AWG).
3. When the internal voltages of two devices are different, make SG (Signal Ground) of the two devices connected with each other to balance their SG voltages and make the communication more stable.

● **Communication Format that RS-485 Supports**

RS-485 communication port supports ASCII or RTU communication formats and the supported baud rate can be up to 115200bps.

Baud rate	9600, 19200, 38400, 57600, 115200					
Mode	ASCII				RTU	
Communication format	7,E,1	7,E,2	7,N,1	7,N,2	8,E,1	8,E,2
	7,O,1	7,O,2	8,E,1	8,E,2	8,N,1	8,N,2
	8,N,1	8,N,2	8,O,1	8,O,2	8,O,1	8,O,2

6.3.4 Supported Function Codes and Exception Codes

● **Modbus Function Codes:**

1. The function codes that RS-485 port of the motion controller supports are listed in the following table.

Function code	Indication	Max. number of writable/readable registers	Available register
16#01	Read output bit register values.	256	Bit register
16#02	Read bit register values.	256	Bit register
16#03	Read one single or multiple word register values.	100	Word register
16#05	Write one single bit register value.	1	Bit register
16#06	Write one single word register value.	1	Word register
16#0F	Write multiple bit register values.	256	Bit register
16#10	Write multiple word register values.	100	Word register

2. The exception codes that RS-485 port of the motion controller supports are listed in the following table.

Exception response code	Indication
16#01	Unsupportive function code
16#02	Unsupportive Modbus address
16#03	The data length is out of the valid range.

6.4 RS-232 Communication Port

6.4.1 Function that RS-232 Port Supports

The RS-232 communication port of the motion controller can function as Modbus master or slave. HMI, PLC or other Modbus device can read and write data in the devices inside the motion controller. The program can not be downloaded through RS-232 port. RS-232 supports Modbus protocol, ASCII mode as well as RTU mode. The function codes which RS-232 port supports include 16#01, 16#02, 16#03, 16#05, 16#06, 16#0F and 16#10. The station addresses that RS-232 port supports are 1~255. The broadcast function is not supported.

Refer to appendix A for details on Modbus communication and Modbus device addresses.

6.4.2 Definitions of RS-232 Port Pins

The motion controller's COM/SSI port consists of 15 pins. See the table below for definitions of respective RS-232 communication port pins.

Pin No.	Signal	Definition
3	Tx	Transmitting data
9	Rx	Receiving data
5	GND	Signal ground

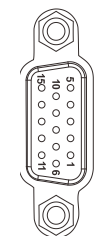

COM/SSI

6.4.3 RS-232 Hardware Connection

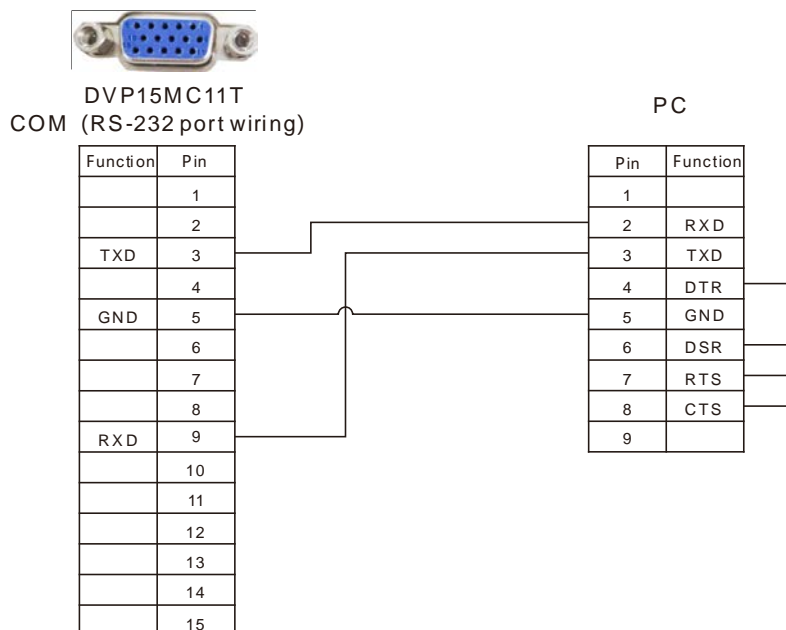

- RS-232 port is connected to HMI when the motion controller functions as a slave.

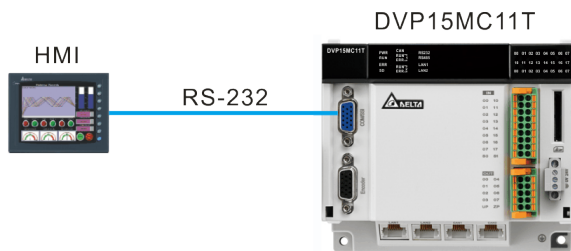

● The communication format that RS-232 supports

Baud rate	9600, 19200, 38400, 57600, 115200					
Mode	ASCII				RTU	
Communication format	7,E,1	7,E,2	7,N,1	7,N,2	8,E,1	8,E,2
	7,O,1	7,O,2	8,E,1	8,E,2	8,N,1	8,N,2
	8,N,1	8,N,2	8,O,1	8,O,2	8,O,1	8,O,2

6.4.4 Supported Function Codes and Exception Codes

● Modbus Function Codes:

1. The function codes that RS-232 port of the motion controller supports are listed in the following table.

Function code	Indication	Max. number of writable/readable registers	Available register
16#01	Read output bit register values.	256	Bit register
16#02	Read bit register values.	256	Bit register
16#03	Read one single or multiple word register values.	100	Word register
16#05	Write one single bit register value.	1	Bit register
16#06	Write one single word register value.	1	Word register
16#0F	Write multiple bit register values.	256	Bit register
16#10	Write multiple word register values.	100	Word register

2. The exception codes that RS-232 port of the motion controller supports are listed in the following table.

Exception code	Indication
16#01	Unsupported function code
16#02	Unsupported Modbus address
16#03	The data length is out of the valid range.

6.5 SSI Absolute Encoder Port

6.5.1 Function of SSI Absolute Encoder

The motion controller's COM/SSI port is a 15-pin D-SUB interface which can be used to connect SSI encoder. In addition, the port also includes the 5V (400mA) power output which provides the power supply to the encoder. Users can create an SSI encoder axis to control the motion of slave axes according to the number of pulses received via the encoder port.

6.5.2 Definitions of SSI Port Pins

The motion controller's COM/SSI port is a 15-pin D-SUB interface. See the table below for definitions of respective SSI communication port pins.

Pin No.	Signal	Definition
1	DATA+	Positive pole of absolute encoder data
2	DATA-	Negative pole of absolute encoder data
6	CLK+	Positive pole of absolute encoder clock
14	CLK-	Negative pole of absolute encoder clock
8	GND	Power ground of the absolute encoder
15	5V	Absolute encoder power

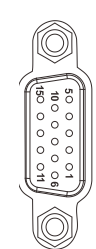

COM/SSI

6.5.3 SSI Absolute Encoder Hardware Connection

- Illustration of SSI Absolute Encoder Wiring

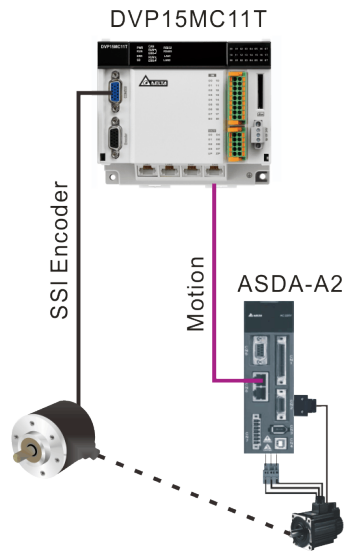

- Specification for SSI Absolute Encoder Interface Wiring
SSI encoder interface of the motion controller and the wiring method are shown below.

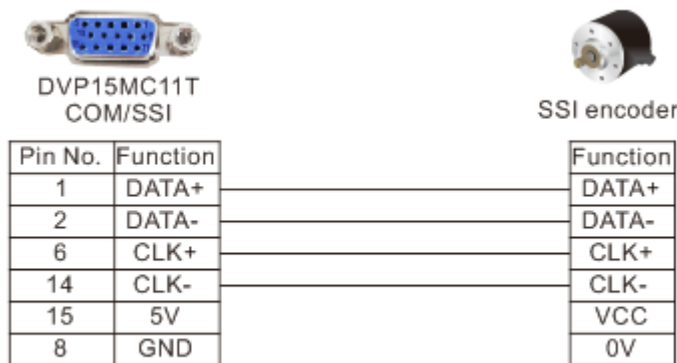

Note: The power supply for COM/SSI port of the motion controller is 5V power.
 When VCC = 5V, connect the power voltage VCC of SSI encoder to pin 15 of COM/SSI interface and 0V of SSI encoder to pin 8 of COM/SSI interface.
 When VCC ≠ 5V, the power is supplied to SSI encoder alone according to the actual power voltage of the SSI encoder which is connected.

- Specification for SSI Absolute Encoder Communication Cable
Please use the shielded pair-twisted cable for CLK+, CLK-, DATA+ and DATA- signal transmission.

6.6 Incremental Encoders

6.6.1 Function of Incremental Encoder

The motion controller's incremental encoder port is a 15-pin D-SUB interface which can connect two independent incremental encoders. Both of the two encoder ports support differential signal input with maximum work frequency of 1MHz (250Kx 4 = 1MHz) per one. Additionally, the port integrates two 5V (400mA) power outputs to supply power to the two encoders. Users can create an incremental encoder axis for either of the two encoders to control the motion of slave axes according to the number of pulses received at the encoder port.

6.6.2 Definition of Incremental Encoder Port Pins

The motion controller's incremental encoder port is a 15-pin interface. See the table below for definitions of respective encoder communication port pins.

Pin No.	Signal	Definition
1	A1+	Differential signals of the first incremental encoder
2	A1-	
10	B1+	
11	B1-	
4	Z1+	
5	Z1-	
15	+5V	Power supply for the first encoder
3	A2+	Differential signals of the second incremental encoder
9	A2-	
6	B2+	
12	B2-	
13	Z2+	
14	Z2-	
7	+5V	Power supply for the second encoder
8	0V	0V shared by the two encoders
Outer metal shell		Shielding layer

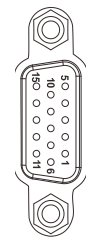

6.6.3 Incremental Encoder Hardware Connection

- Illustration of Incremental Encoder Wiring

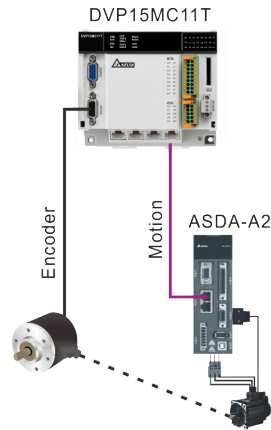

- Specification for Incremental Encoder Port Wiring

The incremental encoder interface of the motion controller and the wiring method are shown below.

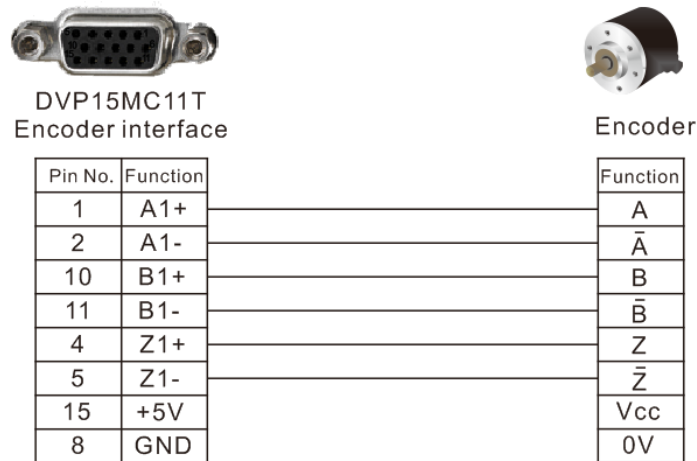

Note: The power supply for Encoder port of the motion controller is 5V power.

1. When VCC = 5V, connect the power voltage VCC of an encoder to pin 15 of the motion controller's Encoder interface and 0V of the encoder to pin 8 of Encoder interface.
2. When VCC ≠ 5V, the power is supplied to the encoder alone according to the actual power voltage of the encoder which is connected.

6.7 Ethernet Communication Port

6.7.1 Function that Ethernet Communication Port Supports

There are two independent Ethernet communication ports: LAN1 and LAN2 in the motion controller, and their IP addresses need be set individually.

Both of the two Ethernet ports can be used to download configuration files, execution files and CAM files. They also support automatic jumper function and users do not need to additionally select wire jumper when one of Ethernet ports is connected to the computer or switchboard. Besides, they can automatically detect the transmission speed of 10Mbps and 100 Mbps as well.

HMI, PLC or other Modbus TCP master device can read and write data in the devices inside the motion controller via the two Ethernet ports. For details on Modbus TCP communication, refer to appendix B.

Both of the two Ethernet ports support Modbus protocol. LAN1 port can work as a slave only and LAN2 port can work as a master or a slave. LAN2 supports EtherNet/IP slave function and Socket function. For more details on the two ports, see the following table.

Item		LAN1	LAN2
Communication protocol		MODBUS TCP	MODBUS TCP, Socket, EtherNet/IP
MODBUS TCP	Connections (Server)	16	16
	Connections (Client)	0	
Socket	TCP connections	0	8
	UDP connections		
Device type		Adapter	Adapter
EtherNet/IP	CIP_IO Connection	CIP connections	8
		TCP connections	16
		Interval time for sending messages (RPI)	5ms~1000ms
		Maximum data size per message	200bytes
	CIP_Explicit Message	Class 3 (Connected Type)	Unsupported
UCMM (Non-Connected Type)		16	
Supports CIP objects		Identity, Message Router, Assembly, Connection Manager, Port, TCP/IP interface, Ethernet link, Vendor specific	

When the controller serves as the EtherNet/IP slave, IO connections correspond to default start devices as shown in the following table.

Start device IO Connection	Default start device for receiving data from the master	Default start device for sending data to the master
Connection 1	%MW11000	%MW12000
Connection 2	%MW11100	%MW12100
Connection 3	%MW11200	%MW12200
Connection 4	%MW11300	%MW12300
Connection 5	%MW11400	%MW12400
Connection 6	%MW11500	%MW12500
Connection 7	%MW11600	%MW12600
Connection 8	%MW11700	%MW12700

6.7.2 Pins of Ethernet Communication Port

The motion controller has two independent Ethernet ports supporting Modbus TCP protocol with the pins shown in the following table. The two Ethernet ports are independent and their IP addresses need be set separately. The default IP address for LAN1 is 192.168.0.1 and the default IP address for LAN2 is 192.168.1.1.

Pin No.	Signal	Definition
1	Tx+	Positive pole for transmitting data
2	Tx-	Negative pole for transmitting data
3	Rx+	Positive pole for receiving data
4	Reserved	Reserved
5	Reserved	Reserved
6	Rx-	Negative pole for receiving data
7	Reserved	Reserved
8	Reserved	Reserved

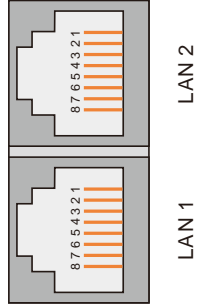

6

6.7.3 Network Connection of Ethernet Communication Port

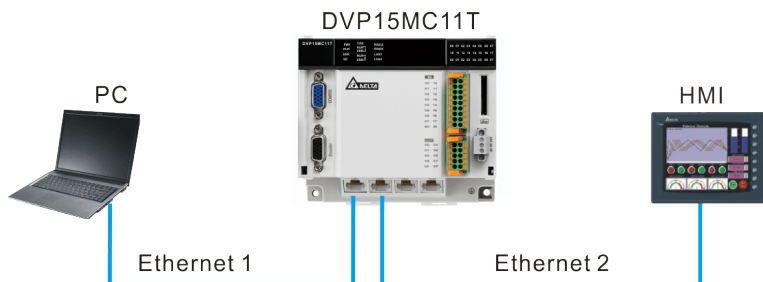

6.7.4 Function Codes that Ethernet Communication Port Supports

Below is the list of the function codes and exception response codes which are supported when the motion controller's Ethernet communication ports LAN1 and LAN2 use Modbus TCP protocol.

Function code	Indication	Max. number of writable/readable registers	Available register
16#01	Read output bit register values.	256	Bit register
16#02	Read bit register values.	256	Bit register
16#03	Read one single or multiple word register values.	100	Word register
16#05	Write one single bit register value.	1	Bit register
16#06	Write one single word register value.	1	Word register
16#0F	Write multiple bit register values.	256	Bit register
16#10	Write multiple word register values.	100	Word register

Exception response code	Indication
16#01	Unsupported function code
16#02	Unsupported Modbus address
16#03	The data length is out of the valid range.

6.8 Motion Communication Port

6.8.1 Function that Motion Communication Port Supports

Motion communication port is used for motion control. Motion instructions control a servo via the communication port. SDO command can be sent out through the communication port. But users can not carry out the PDO configuration through the communication port.

6.8.2 Pins of Motion Communication Port

The following table lists the pins of Motion communication port which is used for the motion control.

Pin No.	Signal	Definition
1	CAN_H	Signal+
2	CAN_L	Signal-
3	CAN_GND	0 VDC
4	Reserved	Reserved
5	Reserved	Reserved
6	Reserved	Reserved
7	CAN_GND	0 VDC
8	Reserved	Reserved

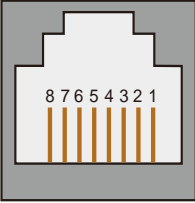

Motion
CAN2

6.8.3 Motion Network Connection

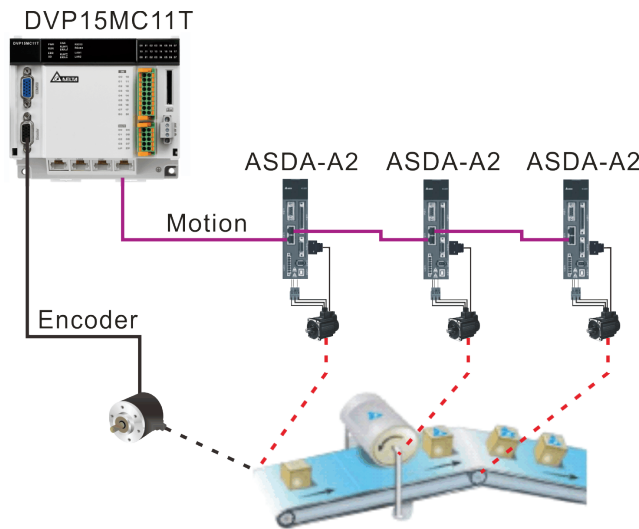

1. The motion controller has one 120 Ohm terminal resistor embedded in its Motion interface.
2. Please use Delta cables as CANopen cables. For specifications of Delta cables, refer to Appendix E

6.8.4 Communication Speed and Communication Distance

The transmission distance of the bus network depends on the transmission speed of Motion bus. Below is the table where the maximum communication distances correspond to different transmission speeds.

Transmission speed (Bit/second)	500K	1M
Max. communication distance (Meter)	100	25

6.9 CANopen Communication Port

6.9.1 Functions that CANopen Communication Port Supports

CANopen communication port can be used as CANopen network master or as a slave of other master.

- As a master, CAN1 communication port supports following functions.
 - Standard CANopen protocol DS301V4.02;
 - NMT (Network Management Object) Master service;
 - NMT Error control;
NMT error control is used to watch if some slave is offline. NMT error control includes Heartbeat and Node Guarding. The module supports Heartbeat function.
 - Connects max. 32 slaves.
 - PDO (Process Data Object) service.

The number of RxPDOs: max. 200, data length: max. 1000 bytes

The number of TxPDOs: max. 200, data length: max. 1000 bytes

Maximum 8 TxPDOs and 8 RxPDOs are configured for each slave.

PDO transmission type: supporting event trigger, time trigger, synchronous and cyclic, synchronous and acyclic

PDO mapping: every PDO can map 32 parameters at most.

The data type that CAN communication port supports

Storage capacity	Data type
1bit	BOOL
8bit	SINT, USINT, BYTE
16bit	INT, UINT, WORD
32bit	DINT, UDINT, REAL, DWORD
64bit	LINT, ULINT, LREAL, LWORD

- Supports SDO service
Supports standard expedited SDO transmission mode;
Supports Auto SDO function; capable of sending a maximum of 30 Auto SDOs to each slave;
Supports reading and writing of slave data by using SDO service in PLC ladder diagram program.
- SYNC producer, range 0-65535ms
Multiple devices perform an action synchronously through SYNC message.
- As the connection interface between Delta CANopen Builder configuration software and CANopen network, the configuration software can be directly used to configure the network through DVPCOPM-SL module
- Supports the CANopen communication speeds: 20K, 50K, 125K, 250K, 500K, 1Mbps
- As a slave, CAN1 communication port supports following functions.
 - Standard CANopen protocol DS301V4.02
 - NMT slave service
 - NMT Error control
Supporting Heartbeat Protocol error control instead of Node Guarding error control
 - PDO service
The number of RxPDOs: max. 8, data length: max. 64 bytes
The number of TxPDOs: max .8, data length: max. 64 bytes
 - PDO transmission type: event trigger, time trigger, synchronous and cyclic, synchronous and acyclic
 - SDO service

Supporting standard expedited SDO transmission mode.

6.9.2 Pins of CANopen Communication Port

The motion controller’s CANopen communication port is used in the standard CANopen communication and its pin descriptions are listed in the following table.

Pin No.	Signal	Definition
1	CAN_H	Signal+
2	CAN_L	Signal-
3	CAN_GND	0 VDC
4	Reserved	Reserved
5	Reserved	Reserved
6	Reserved	Reserved
7	CAN_GND	0 VDC
8	Reserved	Reserved

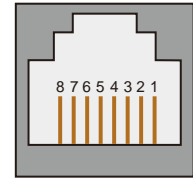

6.9.3 PDO Mapping at CANopen Communication Port

The input mapping area is %MW5000~%MW5499 and output mapping area is %MW5500~%MW5999 when the motion controller works as CANopen master.

The input mapping area is %MW5000~%MW5031 and output mapping area is %MW5500~%MW5531 when the motion controller works as CANopen slave.

6.9.4 Network Connection at CANopen Communication Port

- CANopen Bus Terminals and Network Topology**

Both of the two ends of a CANopen network need be connected with the terminal resistors of 120Ω to enhance the stability of CANopen communication. See the illustration of a basic CAN network topology below.

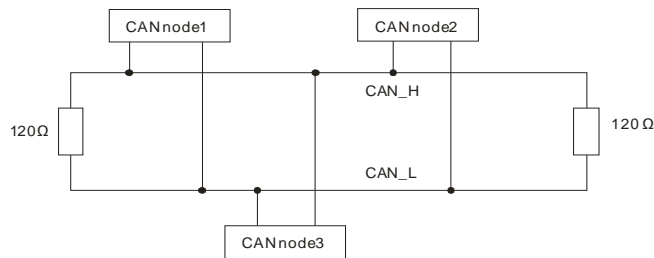

- CANopen Bus Network Topology**

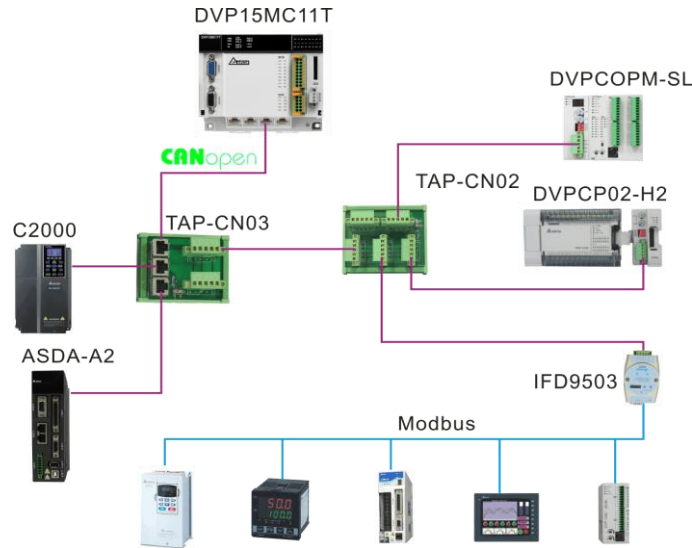

- 1> Delta's standard cables such as UC-DN01Z-01A thick cable, UC-DN01Z-02A thin cable and UC-CMC010-01A thin cable are recommended to use in construction of a CANopen network. The communication cable must keep away from the power cable.
- 2> The terminal resistor of 120Ω should be connected between CAN_H and CAN_L of two respective ends of the network. Users can purchase Delta terminal resistor, TAP-TR01.

6.9.5 CANopen Communication Rate and Communication Distance

The transmission distance of CANopen bus network depends on the transmission speed of CANopen bus. Below is the table where the maximum communication distances correspond to different transmission speeds.

Transmission speed (Bit/second)	20K	50K	125K	250K	500K	1M
Max. communication distance (Meter)	2500	1000	500	250	100	25

MEMO

Chapter 7 Execution Principle

Table of Contents

7.1	Tasks	7-2
7.1.1	Task Types	7-2
7.1.2	Priority levels of Tasks	7-4
7.1.3	Watchdog for a Task	7-6
7.1.4	Motion and Communication Instructions for Each Task Type	7-7
7.2	The Impact of PLC RUN or STOP on Variables and Devices	7-10
7.3	Relationship between Motion Program and Motion Bus	7-10
7.4	Synchronization Cycle Period Setting	7-11

7.1 Tasks

- Tasks are a series of functions of processing specified execution conditions and execution sequences for I/O refresh and user program execution.
- A task is defined with a name, priority level and type. Tasks can be classified into three types, the cyclic task, freewheeling task and event-triggered task.
- For every task, a group of POU's which are triggered by the task can be specified. If the task is executed in current period, the POU's will be processed within a period of time.
- The priority level and task type determine the execution sequence of the task.
- A watchdog can be assigned for every task.

7.1.1 Task Types

- **Three task types that DVP-15MC series motion controller supports**
 1. Cyclic
 2. Freewheeling
 3. Triggered by event
- **Maximum 24 tasks that DVP-15MC series motion controller supports are respectively described below.**

■ Cyclic task

The cyclic task will be executed cyclically according to the set time interval.

➤ The way the cyclic task is executed

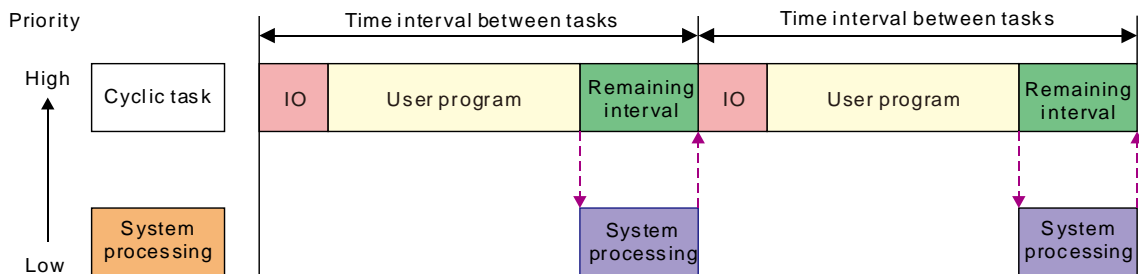

IO: IO means I/O refresh. I/O includes local I/O points and left-side and right-side extension module data and CANopen data. The data can be specified to refresh before the set task is executed. If not specified, the data will be refreshed during the system processing.

User Program: User Program stands for user program execution which is based on the execution sequences of programs assigned in a task.

Remaining interval:

When the controller is to perform system processing, the low-priority task is executed first if any and then the system processing is performed.

System processing:

The controller will perform the system processing which includes Ethernet, RS232 and RS485 communication processing after all task requests are completed.

The four terms mentioned above have the same meanings as those in the following sections.

Note: If the cycle set for a cyclic task is too short, after the user program execution is finished, the task execution will be repeated immediately and no low-priority task or no system processing will be executed. In this case, the execution of all tasks will be affected. If the watchdog is set for the task, the watchdog timeout will occur, the controller will enter Error status and user program execution will stop. If the watchdog is not set for the task, the controller will not be

able to perform system processing and the problems such as communication timeout will take place.

■ **Freewheeling task**

Freewheeling task : The task will be handled as soon as the program running starts. The task will be restarted automatically in the next cycle after one execution cycle ends.

➤ **The way a freewheeling task is executed**

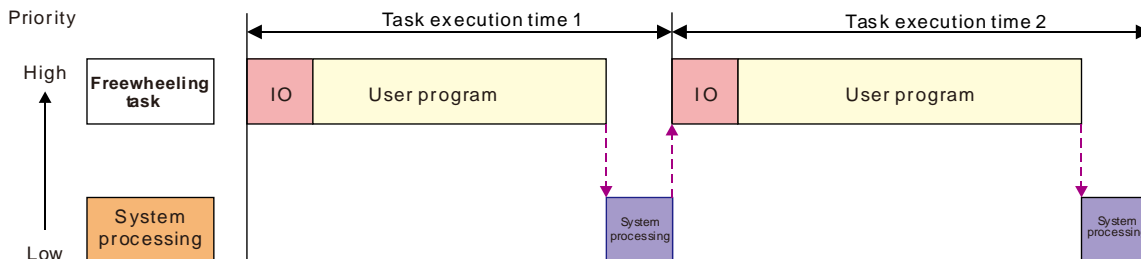

Note: There is no fixed execution time for the freewheeling task. So the values of task execution time 1 and task execution time 2 may not be equal in the above figure.

■ **Task triggered by event**

Event task : An event task is executed once just when the specified event happens. The timing for execution of an event task depends on the timing for occurring of the event and the priority level of the event task.

➤ **The way an event task is executed**

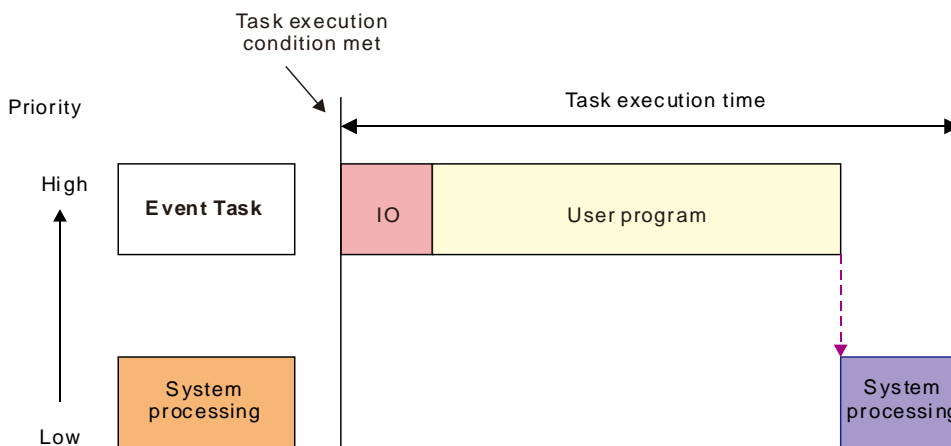

➤ **The event tasks for option contain following few types.**

- Motion event (Motion control task)
- Rising edge or falling edge of local input points (I0~I7 and I10~I17)
- CANopen SYNC signal
- Z pulse rising edge of incremental encoder 1 or encoder 2

The condition for the second-time execution is ignored when the condition required for execution of the event task is met again before the event task is completed. The period before an event task is completed is the course while the event task is being executed or is waiting to be executed.

● **Motion Event**

Motion port of the controller sends out SYNC signal and the task is triggered.

Note: The motion task is set to priority 1 by default. The priority level can be modified. However, make sure that there is enough time for execution of the motion task within CANopen SYNC period.

■ **SYNC cycle setting should meet following conditions.**

- There must be enough time for execution of the program defined in a motion task.
- There must be sufficient time for PDO and SDO data exchange between the controller and servo drive.

Insufficient SYNC period time will result in the controlled device to fail to receive SYNC signal and unpredictable operations. Refer to section 7.3 for SYNC period setting.

● **Rising edge or falling edge of local input points (I0~I7 · I10~I17)**

The task is triggered when rising edge or falling edge of input point signal is detected. The response time of input points can be set through the filter function.

● **CANopen bus SYNC message**

The task is triggered when SYNC signal is produced at CANopen port of the controller.

● **Z pulse rising edge for incremental encoder 1**

The task is triggered when the rising edge of Z signal of the first encoder is detected at Encoder port of the controller.

● **Z pulse rising edge for incremental encoder 2**

The task is triggered when the rising edge of Z signal of the second encoder is detected at Encoder port of the controller.

7.1.2 Priority levels of Tasks

The controller can not perform multiple tasks simultaneously. Every task must be given a priority level and they are executed according to preset priorities. Priority level can be set within the range of 1 to 24. (1 is the highest priority and 24 is the lowest priority.) The priority level of each task must be unique. The task with higher priority takes priority to perform. The high-priority task can interrupt the low-priority task.

We recommend that the task which has a high requirement of real time should be given a high priority and the task which has a low requirement of real time should be given a low priority. The priority of the default motion control task built in the CANopen Builder software is 1 by default.

● **The principle for multi-task execution**

■ **When the execution conditions of two tasks are met simultaneously (Cyclic task and freewheeling task)**

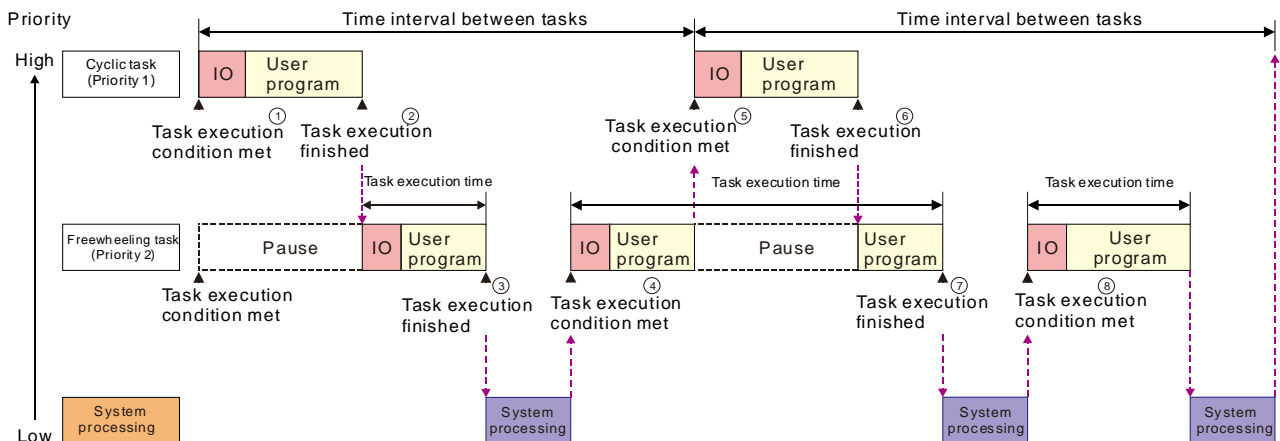

- ① The execution conditions for the cyclic task and freewheeling task are met at the same time. The cyclic task is executed first because of its higher priority.
- ② When the cyclic task execution is finished, the freewheeling task execution starts.
- ③ The controller will execute the system processing if there is no other task after the execution of the freewheeling task is completed.
- ④ The execution of the freewheeling task continues since the high-priority cyclic task request has not arrived.
- ⑤ The cyclic task interrupts the freewheeling task execution and the controller executes the cyclic task because of the arrival of the high-priority cyclic task request during the execution of the freewheeling task.
- ⑥ The controller continues to execute the part of the low-priority freewheeling task, which has not been executed yet when the execution of the cyclic task is completed.
- ⑦ When the execution of the freewheeling task is completed, the controller executes the system processing due to no other task request.
- ⑧ When the system processing is completed, the execution of the freewheeling task continues due to no high-priority cyclic task request.

■ When three tasks are executed in mixture (Event task, Cyclic task and Freewheeling task)

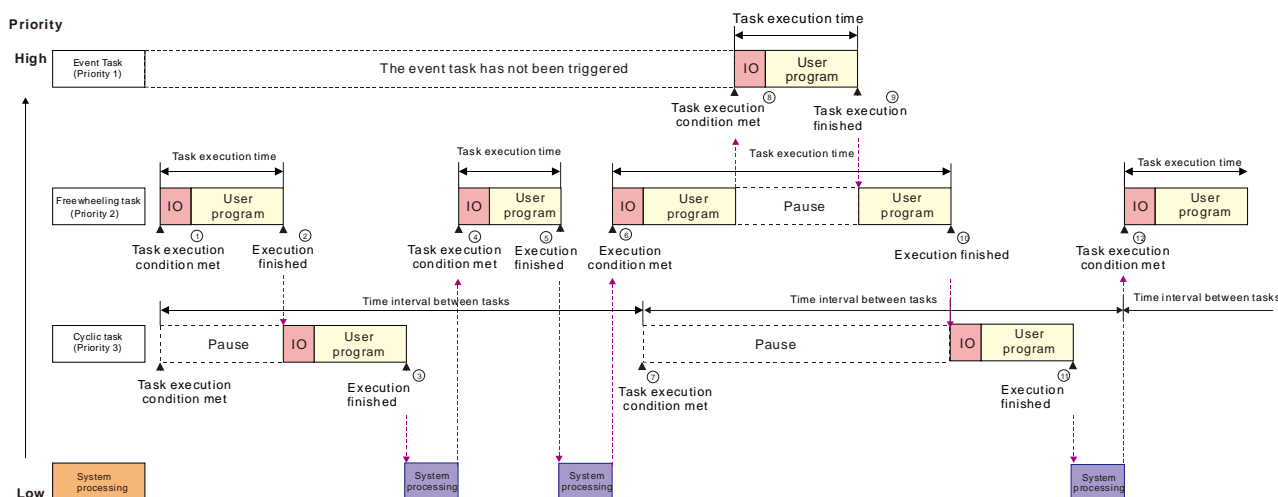

- ① When the conditions for execution of the freewheeling task and cyclic task are both met, the freewheeling task is executed first because the priority of the freewheeling task is higher.
- ② The cyclic task execution starts when the freewheeling task execution is completed.
- ③ When the cyclic task execution is completed, the controller executes the system processing due to no other task request.
- ④ The freewheeling task is executed when the system processing is completed.
- ⑤ When the freewheeling task execution is completed, the controller executes the system processing due to no other task request.
- ⑥ The freewheeling task is executed when the system processing is completed.
- ⑦ The freewheeling task execution continues because the freewheeling task has a higher priority than the cyclic task although the execution condition for the cyclic task is met. And the cyclic task waits to execute.
- ⑧ The event task interrupts the freewheeling task execution because the event task has the highest priority and the execution condition for the event task is met.
- ⑨ The controller continues to execute the part of the low-priority freewheeling task, which has not been executed yet when the event task execution is completed.

- ⑩ The freewheeling task execution is completed. The controller executes the cyclic task since the cyclic task request in ⑦ is not responded yet.
- ⑪ The cyclic task execution is completed. The controller executes the system processing due to no other task request.

7.1.3 Watchdog for a Task

Every task can be given a watchdog. When the task execution time exceeds the set watchdog time, the controller will enter Error state and the user program execution will stop.

Watchdog time: The longest time allowed for the execution of a task

7.1.4 Motion and Communication Instructions for Each Task Type

Here is the table of motion instructions for different task types. “V” means the motion instruction can be executed for the task type and “-” means the motion instruction can not be executed for the task type.

Classification	Instruction name	Task type			
		Cyclic task	Freewheeling task	Event-triggered task	
				Motion task	Motion task
Single-axis instructions	MC_Power	-	-	V	-
	MC_Home	-	-	V	-
	MC_MoveVelocity	-	-	V	-
	MC_Halt	-	-	V	-
	MC_Stop	-	-	V	-
	MC_MoveRelative	-	-	V	-
	MC_MoveAdditive	-	-	V	-
	MC_MoveAbsolute	-	-	V	-
	MC_MoveSuperimposed	-	-	V	-
	MC_Haltsuperimposed	-	-	V	-
	MC_SetPosition	-	-	V	-
	MC_SetOverride	-	-	V	-
	MC_Reset	-	-	V	-
	DMC_SetTorque	-	-	V	-
	MC_ReadAxisError	V	V	V	V
	MC_ReadActualPosition	V	V	V	V
	MC_ReadStatus	V	V	V	V
	MC_ReadMotionState	V	V	V	V
	DMC_ReadParameter_Motion	V	V	V	V
	DMC_WriteParameter_Motion	V	V	V	V
	DMC_TouchProbe	-	-	V	-
	DMC_ChangeMechanismGearRatio	-	-	V	-
	DMC_Jog	-	-	V	-
	DMC_MoveVelocity	-	-	V	-
	DMC_MoveVelocityStopByPos	-	-	V	-
	DMC_MoveVelocityStopByLinePos	-	-	V	-
	DMC_ReadPositionLagStatus	V	V	V	V
	DMC_SwitchSoftLimit	V	V	V	V
DMC_TorqueControl	-	-	V	-	
DMC_TouchProbeCyclically	-	-	V	-	
DMC_WritePositionLagSetting	V	V	V	V	

Classification	Instruction name	Task type			
		Cyclic task	Freewheeling task	Event-triggered task	
				Motion task	Motion task
Multi-axis instructions	MC_GearIn	-	-	V	-
	MC_GearOut	-	-	V	-
	MC_CombineAxes	-	-	V	-
	MC_CamIn	-	-	V	-
	MC_CamOut	-	-	V	-
	DMC_CamAddTappet	V	V	V	V
	DMC_CamDeleteTappet	V	V	V	V
	DMC_CamReadPoint	V	V	V	V
	DMC_CamWritePoint	V	V	V	V
	DMC_CamSet	-	-	V	-
	DMC_CamReadTappetStatus	V	V	V	V
	DMC_CamReadTappetValue	V	V	V	V
	DMC_CamWriteTappetValue	V	V	V	V
Application instructions	APF_RotaryCut_Init	-	-	V	-
	APF_RotaryCut_In	-	-	V	-
	APF_RotaryCut_Out	-	-	V	-
G code instructions	DMC_CartesianCoordinate	-	-	V	-
	DMC_ReadMFunction	V	V	V	V
	DMC_ResetMFunction	V	V	V	V
	DMC_SetG0Para	V	V	V	V
	DMC_SetG1Para	V	V	V	V
	DMC_SetStartPosition	V	V	V	V
Axes group instructions	DMC_AddAxisToGroup	-	-	V	-
	DMC_RemoveAxisFromGroup	-	-	V	-
	DMC_UngroupAllAxes	-	-	V	-
	DMC_GroupEnable	-	-	V	-
	DMC_GroupStop	-	-	V	-
	DMC_GroupInterrupt	-	-	V	-
	DMC_GroupContinue	-	-	V	-
	DMC_MoveDirectAbsolute	-	-	V	-
	DMC_MoveDirectRelative	-	-	V	-
	DMC_MoveLinearAbsolute	-	-	V	-
	DMC_MoveLinearRelative	-	-	V	-
	DMC_MoveCircularAbsolute	-	-	V	-
DMC_MoveCircularRelative	-	-	V	-	

Classification	Instruction name	Task type			
		Cyclic task	Freewheeling task	Event-triggered task	
				Motion task	Motion task
	DMC_GroupSetOverride	-	-	V	-
	DMC_GroupReadActualPosition	V	V	V	V
Coordination Instructions	DMC_ControlAxisByPos	-	-	V	-
	DMC_NC	-	-	V	-
Communication instructions	DMC_ReadParameter_CANopen	V	V	V	V
	DMC_WriteParameter_CANopen	V	V	V	V
	ETH_Link_Config	V	V	V	V
	ETH_Link_Manage	V	V	V	V
	ETH_Link_Status	V	V	V	V
	ETH_Link_Config_Ext	V	V	V	V
	ETH_SetServerlinkkeepime	V	V	V	V
	ETH_Socket_Manage	V	V	V	V
	ETH_Socket_Config	V	V	V	V
	ETH_Socket_Open	V	V	V	V
	ETH_Socket_Send	V	V	V	V
	ETH_Socket_Receive	V	V	V	V
	ETH_Socket_Close	V	V	V	V
	ETH_Socket_Status	V	V	V	V
	RS485_Link_Manage	V	V	V	V
	RS485_Link_Config	V	V	V	V
	RS485_Link_Status	V	V	V	V
	RS485_RS	V	V	V	V
	RS485_SetDelayTime	V	V	V	V
	RS232_Link_Manage	V	V	V	V
	RS232_Link_Config	V	V	V	V
	RS232_Link_Status	V	V	V	V
RS232_RS	V	V	V	V	
RS232_SetDelayTime	V	V	V	V	

7.2 The Impact of PLC RUN or STOP on Variables and Devices

When DVP-15MC series motion controller is switched from RUN to STOP, variables and devices keep current values. When DVP-15MC series motion controller is switched from STOP to RUN, users can select one option that the values of variables and non-latched devices are cleared or retained as below.

- **The values of variables and non-latched devices are cleared.**

When DVP-15MC series motion controller is switched from STOP to RUN, the values of variables and non-latched devices are cleared and restored to the initial values. If variables and non-latched devices have no initial values, the values of variables and non-latched areas will be restored to the default value 0.

- **The values of variables and devices are retained.**

When DVP-15MC series motion controller is switched from STOP to RUN, variables and devices keep current values.

7.3 Relationship between Motion Program and Motion Bus

DVP-15MC series motion controller makes the synchronization achieved through issuing SYNC signal in the method of broadcasting while more than one servo is connected with DVP-15MC series motion controller. The servo drives receive the control data sent by DVP-15MC series motion controller. But the control data received will not be effective right away until the SYNC signal comes to the servos so as to realize the synchronization of multiple servos.

In the following figure, DVP-15MC series motion controller is connected with 4 servo drives and T is the synchronization period. The four servo drives receive control data at different time (t1, t2, t3 and t4) but the control data received are not effective at once. As the servo drives receive SYNC signal, the control data will go effective immediately.

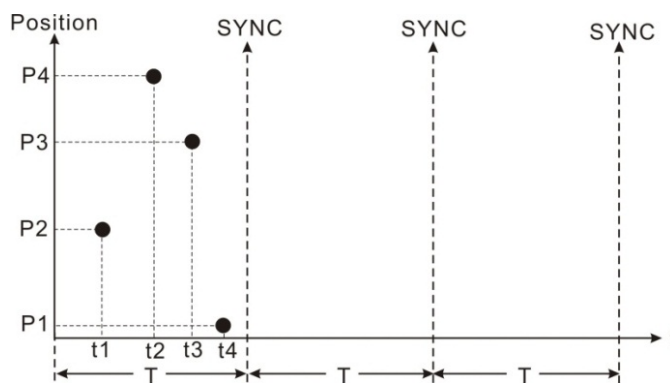

7.4 Synchronization Cycle Period Setting

The synchronization cycle is a very important parameter for the bus motion control. If the synchronization period is not set properly, the servo may display AL303/AL302/AL301 fault alarm in communication or the servo could not run normally.

Let's introduce the constitution of the synchronization period first.

The motion control program is scanned at the very beginning of the synchronization period, and then the control messages got through calculation are sent to all axes. So we can regard the synchronization period as the time for execution of motion control program plus the time for communication between DVP-15MC series motion controller and all servos.

The time for execution of motion control program is the maximum execution time of motion event tasks with the unit: μs (microsecond) which can be viewed by double clicks on **Task** on the CANopen Builder software interface. 1000 μs (microseconds) are 1ms (millisecond).

The value is rounded up to an integer in the actual application. For example, the maximum time for program execution is 2567 μs =2.5ms, in this case, we can regard 3ms as the time for program execution.

It is about 0.5ms for the communication between DVP-15MC series motion controller and a servo.

We recommend that the value is rounded up to an integer in application. For example, 5 servos are configured in an application. And the communication time is 5*0.5ms=2.5ms. In this case, we can regard 3ms as the time for communication.

Therefore, we can get the formula: a synchronization time (ms) = an integer obtained by rounding up the value of maximum program execution time (ms) + time for the communication between DVP-15MC series motion controller and all servos (ms) +1 (time reserved for a program change) (ms).

If the running time of the program is increased too much after the program changes, the preset synchronization time will not fit any more. So the reserved time should be set to 1~2ms.

For example, the maximum program execution time is 1634 μs and there are totally 5 servos in the application. The reserved time for a program change is 1ms.

A synchronization cycle period= 2ms (obtained by rounding up the maximum program execution time, 1634 μs) + 3ms (obtained by rounding up 5*0.5) +1ms (reserved for a program change)=6ms

Note:

The above method is used for getting an estimated time, which is suitable for most applications. If you need a more precise synchronization cycle period, the actual time can be recalculated by omitting the reserved time after the application development is completed.

MEMO

Chapter 8 Logic Instructions

Table of Contents

8.1	Table of Logic Instructions	8-5
8.2	Explanation of Logic Instructions	8-9
8.2.1	EN and ENO	8-9
8.3	Sequence Input /Output Instructions	8-9
8.3.1	R_TRIG	8-9
8.3.2	F_TRIG.....	8-11
8.3.3	RS	8-13
8.3.4	SR	8-15
8.3.5	SEMA	8-17
8.4	Sequence Control Instructions	8-19
8.4.1	JMP.....	8-19
8.5	Data Movement Instructions	8-20
8.5.1	MOVE.....	8-20
8.5.2	MoveBit	8-21
8.5.3	TransBit.....	8-23
8.5.4	MoveDigit	8-25
8.5.5	Exchange.....	8-27
8.5.6	Swap	8-29
8.6	Comparison Instructions	8-31
8.6.1	LT.....	8-31
8.6.2	LE.....	8-33
8.6.3	GT	8-35
8.6.4	GE	8-37
8.6.5	EQ.....	8-39
8.6.6	NE	8-41
8.7	Timer Instructions.....	8-43
8.7.1	TON	8-43
8.7.2	TOF.....	8-45
8.7.3	TP.....	8-47
8.7.4	Sys_ReadTime.....	8-49
8.7.5	Sys_ReadTotalWorkTime.....	8-50
8.7.6	Sys_ReadPowerOnTime	8-51
8.7.7	Sys_WdgStatus	8-52
8.8	Counter Instructions	8-54
8.8.1	CTU	8-54
8.8.2	CTD	8-56
8.8.3	CTUD	8-58

8.9	Math Instructions	8-61
8.9.1	ADD	8-61
8.9.2	SUB	8-64
8.9.3	MUL	8-67
8.9.4	DIV	8-70
8.9.5	MOD	8-73
8.9.6	MODREAL	8-75
8.9.7	MODTURNS	8-77
8.9.8	MODABS	8-79
8.9.9	ABS	8-81
8.9.10	DegToRad	8-83
8.9.11	RadToDeg	8-85
8.9.12	SIN	8-87
8.9.13	COS	8-89
8.9.14	TAN	8-91
8.9.15	ASIN	8-93
8.9.16	ACOS	8-95
8.9.17	ATAN	8-97
8.9.18	LN	8-99
8.9.19	LOG	8-101
8.9.20	SQRT	8-103
8.9.21	EXP	8-105
8.9.22	EXPT	8-107
8.9.23	RAND	8-109
8.9.24	TRUNC	8-111
8.9.25	FLOOR	8-113
8.9.26	FRACTION	8-115
8.10	Bit String Instructions	8-117
8.10.1	AND	8-117
8.10.2	OR	8-120
8.10.3	NOT	8-123
8.10.4	XOR	8-125
8.10.5	XORN	8-128
8.11	Shift Instructions	8-131
8.11.1	SHL	8-131
8.11.2	SHR	8-133
8.11.3	ROL	8-135
8.11.4	ROR	8-137
8.12	Selection Instructions	8-139
8.12.1	MAX	8-139
8.12.2	MIN	8-141
8.12.3	SEL	8-143
8.12.4	MUX	8-145
8.12.5	LIMIT	8-147
8.12.6	BAND	8-149
8.12.7	ZONE	8-152
8.13	Data Type Conversion Instructions	8-155

8.13.1	BOOL_TO_***	8-155
8.13.2	Bit strings_TO_***	8-158
8.13.3	Integers_TO_***	8-165
8.13.4	Real numbers_TO_***	8-174
8.13.5	Times,dates_TO_***	8-177
8.13.6	Strings_TO_***	8-179
8.14	Communication Instructions	8-182
8.14.1	CANopen Communication Instructions	8-182
8.14.1.1	DMC_ReadParameter_CANopen	8-182
8.14.1.2	DMC_WriteParameter_CANopen	8-187
8.14.2	Ethernet Instructions.....	8-191
8.14.2.1	ETH_Link_Config	8-191
8.14.2.2	ETH_Link_Manage	8-196
8.14.2.3	ETH_Link_Status	8-198
8.14.2.4	MODBUS TCP Data Exchange Example	8-200
8.14.2.5	ETH_Link_Config_Ext	8-207
8.14.2.6	ETH_SetServerlinkkeepTime	8-209
8.14.2.7	ETH_Socket_Manage	8-210
8.14.2.8	ETH_Socket_Config	8-212
8.14.2.9	ETH_Socket_Open	8-215
8.14.2.10	ETH_Socket_Send	8-217
8.14.2.11	ETH_Socket_Receive	8-221
8.14.2.12	ETH_Socket_Close	8-225
8.14.2.13	ETH_Socket_Status	8-227
8.14.2.14	Ethernet Free Protocol Example	8-230
8.14.3	RS485 Communication Instructions.....	8-235
8.14.3.1	RS485_Link_Manage	8-235
8.14.3.2	RS485_Link_Config	8-237
8.14.3.3	RS485_Link_Status	8-241
8.14.3.4	RS485 Data Exchange Example	8-244
8.14.3.5	RS485_RS	8-247
8.14.3.6	RS485 Free Protocol Example	8-253
8.14.3.7	RS485_SetDelayTime	8-256
8.14.4	RS232 Communication Instructions.....	8-258
8.14.4.1	RS232_Link_Manage	8-258
8.14.4.2	RS232_Link_Config	8-260
8.14.4.3	RS232_Link_Status	8-264
8.14.4.4	RS232 Data Exchange Example	8-267
8.14.4.5	RS232_RS	8-270
8.14.4.6	RS232 Free Protocol Example	8-276
8.14.4.7	RS232_SetDelayTime	8-279
8.15	String Processing Instructions	8-281
8.15.1	CONCAT.....	8-281
8.15.2	DELETE.....	8-283
8.15.3	INSERT.....	8-285
8.15.4	LEFT / RIGHT	8-287
8.15.5	MID.....	8-289

8.15.6 REPLACE	8-291
8.15.7 LEN	8-293
8.15.8 FIND	8-294
8.16 Immediate Refresh Instructions	8-296
8.16.1 FROM	8-296
8.16.2 TO	8-300
8.16.3 ImmediateInput	8-304
8.16.4 ImmediateOutput	8-306
8.16.5 Left_Manage	8-308
8.17 PID-related Instructions	8-312
8.17.1 PID	8-312
8.17.2 GPWM	8-323
8.18 Address Instruction	8-325
8.18.1 ADR	8-325
8.19 Network Diagnosis	8-327
8.19.1 Motion Diagnosis	8-327
8.19.1.1 CANmotion_SysDiag (Motion System Diagnosis)	8-327
8.19.1.2 CANmotion_NodeDiag (Motion Axis Diagnosis)	8-329
8.19.2 CANopen Diagnosis	8-331
8.19.2.1 CANopen_SysDiag	8-331
8.19.2.2 CANopen_NodeDiag	8-333
8.19.2.3 CANopen_State	8-335
8.20 Read and Write Offset Bit Value	8-337
8.20.1 SetBitOffsetValue	8-337
8.20.2 GetBitOffsetValue	8-339
8.21 FCS Instructions	8-341
8.21.1 CRC16	8-341
8.21.2 LRC	8-343

8.1 Table of Logic Instructions

Instruction set	Instruction code	Function
Sequence Input/Output Instructions	<u>R_TRIG</u>	Rising Edge Trigger
	<u>F_TRIG</u>	Falling Edge Trigger
	<u>RS</u>	Reset–Priority Instruction
	<u>SR</u>	SET–Priority Instruction
	<u>SEMA</u>	Claim-Priority Instruction
Sequence Control Instructions	<u>JMP</u>	Jump
Data Movement Instructions	<u>MOVE</u>	Move
	<u>MoveBit</u>	Move One Bit
	<u>TransBit</u>	Move Bits
	<u>MoveDigit</u>	Move Digits
	<u>Exchange</u>	Data Exchange
	<u>Swap</u>	Swap Bytes
Comparison Instructions	<u>LT</u>	Less Than
	<u>LE</u>	Less Than or Equal to
	<u>GT</u>	Greater Than
	<u>GE</u>	Greater Than or Equal to
	<u>EQ</u>	Equal to
	<u>NE</u>	Not Equal to
Timer Instructions	<u>TON</u>	On-Delay Timer
	<u>TOF</u>	Off-Delay Timer
	<u>TP</u>	Pulse-type Timer
	<u>Sys_ReadTime</u>	Read Real-Time Clock's Time
	<u>Sys_ReadTotalWorkTime</u>	Read Total Work Time
	<u>Sys_ReadPowerOnTime</u>	Read Power-On Time
	<u>Sys_WdgStatus</u>	Read Task Timeout Status
Counter Instructions	<u>CTU</u>	Up-Counter
	<u>CTD</u>	Down-Counter
	<u>CTUD</u>	Up-Down Counter
Math Instructions	<u>ADD</u>	Addition
	<u>SUB</u>	Subtraction
	<u>MUL</u>	Multiplication

Instruction set	Instruction code	Function
	<u>DIV</u>	Division
	<u>MOD</u>	Integer Modulo Division to Get the Remainder
	<u>MODREAL</u>	Real-Number Modulo Division to Get the Remainder
	<u>MODTURNS</u>	Real-Number Modulo Division to Get Signed Integral Part
	<u>MODABS</u>	Real-Number Modulo Division to Get the Unsigned Modulo Value
	<u>ABS</u>	Absolute value
	<u>DegToRad</u>	Degrees to Radians
	<u>RadToDeg</u>	Radians to Degrees
	<u>SIN</u>	Sine
	<u>COS</u>	Cosine
	<u>TAN</u>	Tangent
	<u>ASIN</u>	Arc sine
	<u>ACOS</u>	Arc cosine
	<u>ATAN</u>	Arc tangent
	<u>LN</u>	Natural Logarithm
	<u>LOG</u>	Base-10 Logarithm
	<u>SQRT</u>	Square Root
	<u>EXP</u>	Natural Exponential Operation
	<u>EXPT</u>	Exponentiation
	<u>RAND</u>	Random Number
<u>TRUNC</u>	Truncate	
<u>FLOOR</u>	Real-Number Floor	
<u>FRACTION</u>	Real-Number Fraction	
Bit String Instructions	<u>AND</u>	Logical AND
	<u>OR</u>	Logical OR
	<u>NOT</u>	Bit Reversal
	<u>XOR</u>	Logical Exclusive OR
	<u>XORN</u>	Logical Exclusive NOR
Shift Instructions	<u>SHL</u>	Shift Bits Left
	<u>SHR</u>	Shift Bits Right
	<u>ROL</u>	Rotate Bits Left
	<u>ROR</u>	Rotate Bits Right

Instruction set	Instruction code	Function
Selection Instructions	<u>MAX</u>	Maximum
	<u>MIN</u>	Minimum
	<u>SEL</u>	Selection
	<u>MUX</u>	Multiplexer
	<u>LIMIT</u>	Limiter
	<u>BAND</u>	Deadband Control
	<u>ZONE</u>	Dead Zone Control
Data Type Conversion Instructions	<u>BOOL_TO ***</u>	Bool Conversion Group
	<u>Bit strings TO ***</u>	Bit String Conversion Group
	<u>Integers TO ***</u>	Integer Conversion Group
	<u>Real numbers TO ***</u>	Real Number Conversion Group
	<u>Times,dates TO ***</u>	Time and Data Conversion Group
	<u>Text strings TO ***</u>	String Conversion Group
Communication Instructions	<u>DMC_ReadParameter_CANopen</u>	Read a parameter value
	<u>DMC_WriteParameter_CANopen</u>	Write a parameter value
	<u>ETH_Link_Config</u>	Configure MODBUS TCP data exchange
	<u>ETH_Link_Manage</u>	Enable/disable MODBUS TCP data exchange
	<u>ETH_Link_Status</u>	Watch MODBUS TCP data exchange status
	<u>ETH_Link_Config_Ext</u>	Configure the extension parameters for MODBUS TCP exchange
	<u>ETH_SetServerlinkkeepertime</u>	Set the connection duration time as the controller works as a slave
	<u>ETH_Socket_Manage</u>	Manage Socket TCP/UDP
	<u>ETH_Socket_Config</u>	Configure Socket data exchange parameters
	<u>ETH_Socket_Open</u>	Enable Socket
	<u>ETH_Socket_Send</u>	Send Socket data
	<u>ETH_Socket_Receive</u>	Receive Socket data
	<u>ETH_Socket_Close</u>	Disable Socket
	<u>ETH_Socket_Status</u>	Read Socket status
	<u>RS485_Link_Manage</u>	Manage RS485 communication
	<u>RS485_Link_Config</u>	Configure RS485 communication parameters
	<u>RS485_Link_Status</u>	Watch RS485 communication status
<u>RS485_RS</u>	Configure RS485 free protocol parameters	

Instruction set	Instruction code	Function
	<u>RS485_SetDelayTime</u>	Set RS485 communication response delay time
	<u>RS232_Link_Manage</u>	Manage RS232 communication
	<u>RS232_Link_Config</u>	Configure RS232 communication parameters
	<u>RS232_Link_Status</u>	Watch RS232 communication status
	<u>RS232_RS</u>	Configure RS232 free protocol parameters
	<u>RS232_SetDelayTime</u>	Set RS232 communication response delay time
String Processing Instructions	<u>CONCAT</u>	Concatenate String
	<u>DELETE</u>	Delete String
	<u>INSERT</u>	Insert String
	<u>LEFT / RIGHT</u>	Get String Left/Right
	<u>MID</u>	Get String
	<u>REPLACE</u>	Replace String
	<u>LEN</u>	String Length
	<u>FIND</u>	Find String
Immediate Refresh Instructions	<u>FROM</u>	Read CR value
	<u>TO</u>	Write Value to CR
	<u>ImmediateInput</u>	Immediate Refresh of Input Points
	<u>ImmediateOutput</u>	Immediate Refresh of Output Points
	<u>Left_Manage</u>	Enable/disable left-side module device mapping
PID-related Instructions	<u>PID</u>	PID operation
	<u>GPWM</u>	Basic pulse width tuning
Address Instruction	<u>ADR</u>	Get the Address
	<u>CANmotion_SysDiag</u>	Motion system diagnosis
	<u>CANmotion_NodeDiag</u>	Motion axis diagnosis
	<u>CANopen_SysDiag</u>	CANopen system diagnosis
	<u>CANopen_NodeDiag</u>	CANopen slave diagnosis
	<u>CANopen_State</u>	CANopen master diagnosis
Read and Write Offset Bit Value	<u>SetBitOffsetValue</u>	Set the value of the specified bit
	<u>GetBitOffsetValue</u>	Read the value of the specified bit
FCS Instructions	<u>CRC16</u>	Calculate CRC Value
	<u>LRC</u>	Calculate LRC Value

8.2 Explanation of Logic Instructions

8.2.1 EN and ENO

If the used instruction has EN and ENO input parameters and the value of EN is FALSE (0), the function of the instruction will not be performed and the output of the instruction will not be updated. However, if the value of EN of the instruction is TRUE (1), the function of the instruction will be performed and the output will be updated.

The output state of ENO is consistent with that of EN. When EN is TRUE, ENO changes to TRUE. When EN is FALSE, ENO changes to FALSE.

When the instruction is a function block (FB) and its EN changes from TRUE to FALSE after the FB instruction is executed, the execution of the FB instruction will continue, but the output values of the FB instruction will not be updated.

8.3 Sequence Input /Output Instructions

8.3.1 R_TRIG

FB/FC	Explanation	Applicable model
FB	R_TRIG is used for the rising edge trigger.	DVP15MC11T DVP15MC11T-06

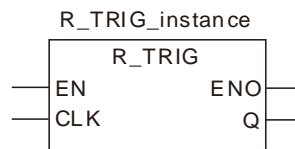

● Parameters

Parameter name	Meaning	Input/Output	Description	Valid range
CLK	Input signal	Input	Rising edge trigger signal	TRUE or FALSE
Q	Output signal	Output	Output for a period	TRUE or FALSE

	Boolean	Bit string				Integer						Real number		Time, date			String			
	BOOL	BYTE	WORD	DWORD	LWORD	USINT	UINT	UDINT	ULINT	SINT	INT	DINT	LINT	REAL	LREAL	TIME	DATE	TOD	DT	STRING
CLK	●																			
Q	●																			

Note:

The symbol ● indicates that the parameter is allowed to connect to the variable or constant of the data type.

● Function Explanation

When CLK of R_TRIG changes from FALSE to TRUE, Q output is TRUE for only one period. In other circumstances, Q is FALSE.

● Precautions for Correct Use

Q will have no output until the rising edge signal at CLK is detected.



Programming Example

■ The variable table and program

Variable name	Data type	Initial value
R_TRG	R_TRIG	
R_TRG_EN	BOOL	FALSE
R_TRG_CLK	BOOL	FALSE
R_TRG_Q	BOOL	

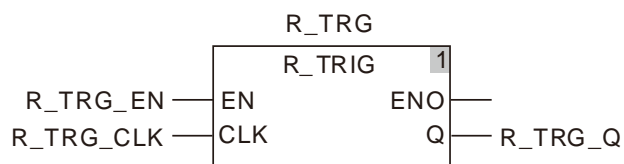

■ Timing Chart:

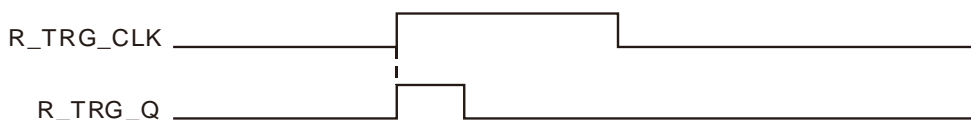

8.3.2 F_TRIG

FB/FC	Explanation	Applicable model
FB	F_TRIG is used for the falling edge trigger.	DVP15MC11T DVP15MC11T-06

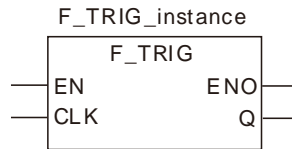

● Parameters

Parameter name	Meaning	Input/Output	Description	Valid range
CLK	Input signal	Input	Falling edge trigger signal	TRUE or FALSE
Q	Output signal	Output	Output for a period	TRUE or FALSE

	Boolean	Bit string					Integer					Real number		Time, date			String			
	BOOL	BYTE	WORD	DWORD	LWORD	USINT	UINT	UDINT	ULINT	SINT	INT	DINT	LINT	REAL	LREAL	TIME	DATE	TOD	DT	STRING
CLK	●																			
Q	●																			

Note:

The symbol ● indicates that the parameter is allowed to connect to the variable or constant of the data type.

● Function Explanation

When CLK of F_TRIG changes from TRUE to FALSE, Q output is TRUE for only one period. In other circumstances, Q is FALSE.

● Precautions for Correct Use

Q will have no output until the falling edge signal at CLK is detected.



Programming Example

■ The variable table and program

Variable name	Data type	Initial value
F_TRG	F_TRIG	
F_TRG_EN	BOOL	FALSE
F_TRG_CLK	BOOL	FALSE
F_TRG_Q	BOOL	

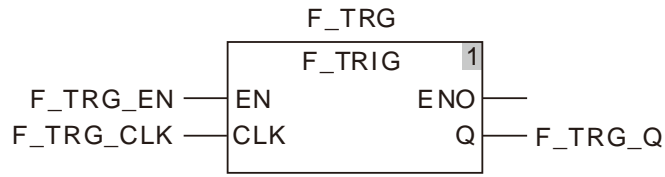

■ **Timing Chart:**



8.3.3 RS

FB/FC	Explanation	Applicable model
FB	RS is used for giving priority to the <i>Reset</i> input.	DVP15MC11T DVP15MC11T-06

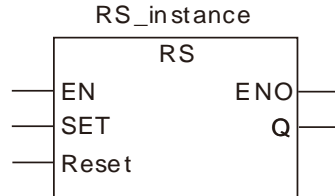

- **Parameters**

Parameter name	Meaning	Input/Output	Description	Valid range
SET	Input signal	Input	SET signal	TRUE or FALSE
Reset	Input signal	Input	Reset signal	TRUE or FALSE
Q	Output signal	Output	Output signal	TRUE or FALSE

	Boolean	Bit string				Integer						Real number		Time, date			String			
	BOOL	BYTE	WORD	DWORD	LWORD	USINT	UINT	UDINT	ULINT	SINT	INT	DINT	LINT	REAL	LREAL	TIME	DATE	TOD	DT	STRING
SET	●																			
Reset	●																			
Q	●																			

Note:

The symbol ● indicates that the parameter is allowed to connect to the variable or constant of the data type.

- **Function Explanation**

When the *SET* and *Reset* inputs of RS are both TRUE, *Reset* is given the priority.

 **Programming Example**

■ **The variable table and program**

Variable name	Data type	Initial value
RS1	RS	
RS1_EN	BOOL	FALSE
RS1_SET	BOOL	FALSE
RS1_Reset	BOOL	FALSE
RS1_Q	BOOL	

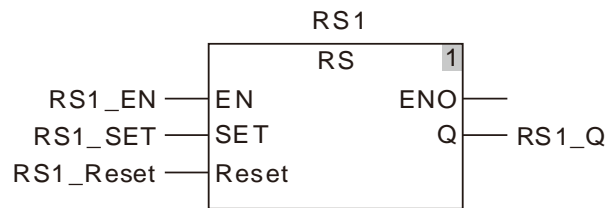

■ **Timing Chart:**

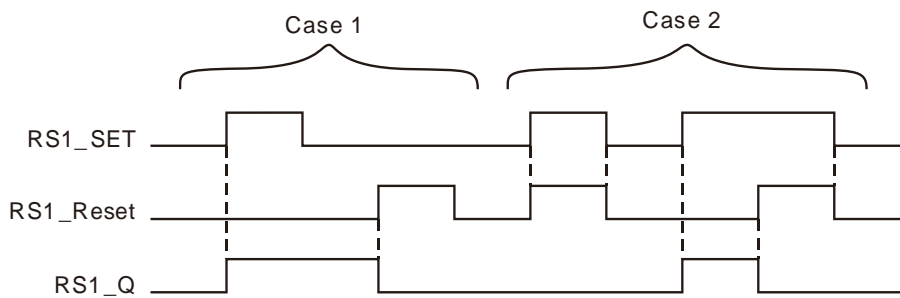

Case 1 : When RS1_SET is TRUE, the output RS1_Q is TRUE. If RS1_Reset is TRUE, RS1_Q is FALSE.

Case 2 : When RS1_Reset is TRUE, RS1_Q is always FALSE.

8.3.4 SR

FB/FC	Explanation	Applicable model
FB	SR is used for giving priority to the <i>Set</i> input.	DVP15MC11T DVP15MC11T-06

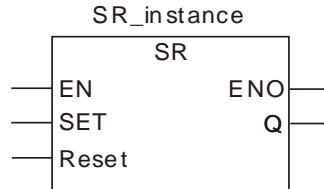

● Parameters

Parameter name	Meaning	Input/Output	Description	Valid range
SET	Input signal	Input	SET signal	TRUE or FALSE
Reset	Input signal	Input	Reset signal	TRUE or FALSE
Q	Output signal	Output	Output signal	TRUE or FALSE

	Boolean	Bit string					Integer						Real number		Time, date				String	
	BOOL	BYTE	WORD	DWORD	LWORD	USINT	UINT	UDINT	ULINT	SINT	INT	DINT	LINT	REAL	LREAL	TIME	DATE	TOD	DT	STRING
SET	●																			
Reset	●																			
Q	●																			

Note:

The symbol ● indicates that the parameter is allowed to connect to the variable or constant of the data type.

● Function Explanation

When the *SET* and *Reset* inputs of RS are both TRUE, *SET* is given the priority.

 **Programming Example**

■ **The variable table and program**

Variable name	Data type	Initial value
SR1	SR	
SR1_EN	BOOL	FALSE
SR1_SET	BOOL	FALSE
SR1_Reset	BOOL	FALSE
SR1_Q	BOOL	

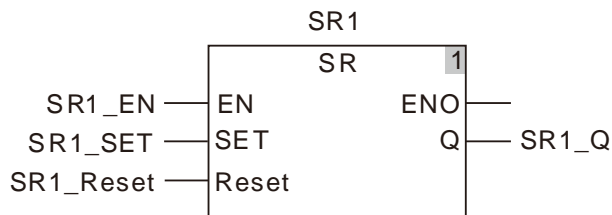

■ **Timing Chart:**

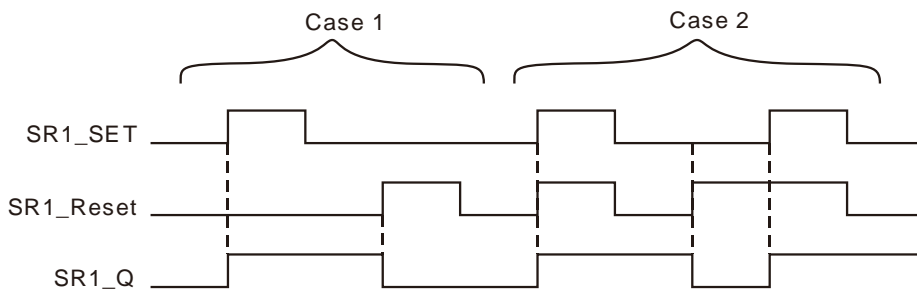

Case 1 : When SR1_SET is TRUE, SR1_Q is TRUE. When SR1_Reset is TRUE, SR1_Q is FALSE.

Case 2 : SR1_SET is given the priority when SR1_SET and SR1_Reset are both TRUE.

8.3.5 SEMA

FB/FC	Explanation	Applicable model
FB	SEMA is used for giving priority to CLAIM. (The output will be valid in the second period.)	DVP15MC11T DVP15MC11T-06

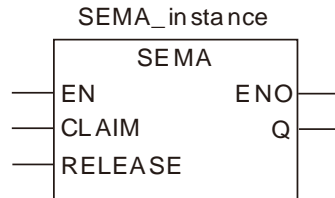

● Parameters

Parameter name	Meaning	Input/Output	Description	Valid range
CLAIM	Input signal	Input	Set signal	TRUE or FALSE
RELEASE	Input signal	Input	Reset signal	TRUE or FALSE
Q	Output signal	Output	Output signal	TRUE or FALSE

	Boolean	Bit string				Integer							Real number		Time, date			String	
	BOOL	BYTE	WORD	DWORD	USINT	UINT	UDINT	ULINT	SINT	INT	DINT	LINT	REAL	LREAL	TIME	DATE	TOD	DT	STRING
CLAIM	●																		
RELEASE	●																		
Q	●																		

Note:

The symbol ● indicates that the parameter is allowed to connect to the variable or constant of the data type.

● Function Explanation

When *CLAIM* of SEMA is TRUE, *Q* is TRUE. When *RELEASE* is TRUE, *Q* is FALSE. When *CLAIM* and *RELEASE* are both TRUE, *Q* is TRUE.

● Precautions for Correct Use

When *CLAIM* is TRUE, *Q* will be TRUE in the second period.

 **Programming Example**

■ **The variable table and program**

Variable name	Data type	Initial value
SEMA1	SEMA	
SEMA1_EN	BOOL	FALSE
SEMA1_CLAIM	BOOL	FALSE
SEMA1_RELEASE	BOOL	FALSE
SEMA1_Q	BOOL	

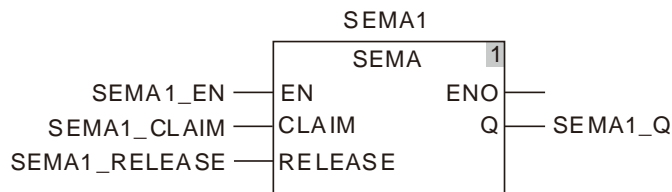

■ **Timing Chart:**

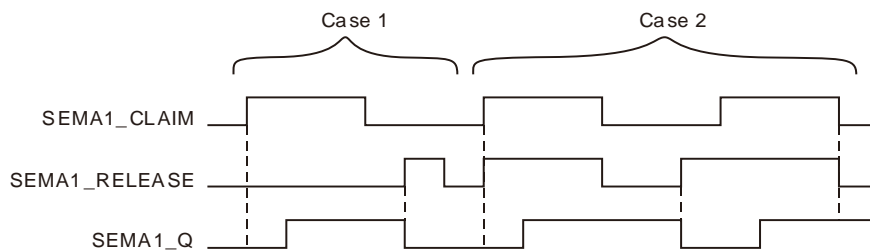

Case 1 : When SEMA1_CLAIM is TRUE, SEMA1_Q is TRUE in the second period. When SEMA1_RELEASE is TRUE, SEMA1_Q changes to FALSE immediately.

Case 2 : When SEMA1_CLAIM is TRUE, SEMA1_Q is TRUE in the second period no matter whether SEMA1_RELEASE is TRUE or FALSE.

8.4 Sequence Control Instructions

8.4.1 JMP

FB/FC	Explanation	Applicable model
FC	JMP is used for jumping to any position specified by a label in the LD program.	DVP15MC11T DVP15MC11T-06

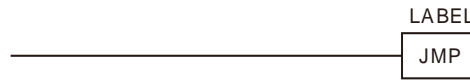

- **Function Explanation**

- JMP is used for jumping to any position specified by a label in the LD program.

- **Precautions for Correct Use**

- Label is any string.
- A key word can not be specified as a label.
- JMP can be used for an upward jump.
- More than one JMP instruction can jump to the same label.
- The label positions to which JMP instructions jump must be in the same POU in the LD program. Otherwise, the jump will not take effect.



Programming Example

Variable table

Variable name	Data type	Current value
Start	BOOL	TRUE
Start1	BOOL	TRUE
Out1	BOOL	FALSE
Start2	BOOL	TRUE
Out2	BOOL	TRUE

Program

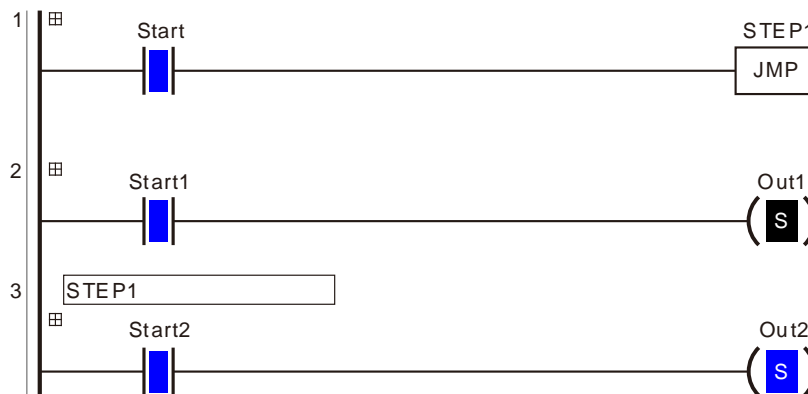

STEP1 is taken as the jump label of JMP instruction in the program above. When **Start** changes to TRUE, JMP instruction will jump to the position of STEP1 label and the program of network 3 will be executed.

When **Start2** changes to TRUE, **Out2** will also change to TRUE; the program of network 2 will not be executed. When **Start** changes to FALSE, the programs from network 1 to network 3 will all be executed.

8.5 Data Movement Instructions

8.5.1 MOVE

FB/FC	Explanation	Applicable model
FC	Move is used for moving data.	DVP15MC11T DVP15MC11T-06

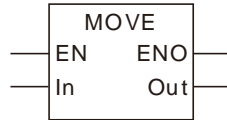

● **Parameters**

Parameter name	Meaning	Input/Output	Description	Valid range
In	Input signal	Input	Move Source	Depends on the data type of the variable that the input parameter is connected to.
Out	Output signal	Output	Move destination	Depends on the data type of the variable that the output parameter is connected to.

	Boolean	Bit string					Integer							Real number		Time, date				String	
	BOOL	BYTE	WORD	DWORD	LWORD	USINT	UINT	UDINT	ULINT	SINT	INT	DINT	LINT	REAL	LREAL	TIME	DATE	TOD	DT	STRING	
In	●	●	●	●	●	●	●	●	●	●	●	●	●	●	●	●	●	●	●	●	●
Out	●	●	●	●	●	●	●	●	●	●	●	●	●	●	●	●	●	●	●	●	●

Note:

The symbol ● indicates that the parameter is allowed to connect to the variable or constant of the data type.

● **Function Explanation**

- The Move instruction moves the value of move source *In* to move destination *Out*.
- The instruction supports the transmission of the values of array elements.

● **Precautions for Correct Use**

The data type of *Out* must be the same as that of *In*. Otherwise, an error will occur in the compiling of the software.



Programming Example

■ **The variable table and program**

Variable name	Data type	Current value
MOVE_EN	BOOL	TRUE
MOVE_In	INT	200
Out1	INT	200

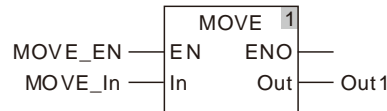

8.5.2 MoveBit

FB/FC	Explanation	Applicable model
FC	MoveBit is used for sending one bit in a string.	DVP15MC11T DVP15MC11T-06

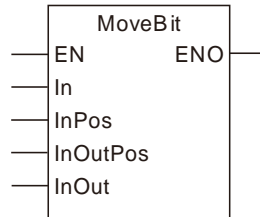

Parameters

Parameter name	Meaning	Input/Output	Description	Valid range
In	Input signal	Input	Move source	Depends on the data type of the variable that the input parameter is connected to.
InPos	Input signal	Input	Move source bit	Depends on the data type of the variable that the input parameter is connected to.
InOutPos	Input signal	Input	Move destination bit	Depends on the data type of the variable that the input parameter is connected to.
InOut	Input signal	Input	Move destination	Depends on the data type of the variable that the input parameter is connected to.

	Boolean	Bit string				Integer						Real number		Time, date			String			
	BOOL	BYTE	WORD	DWORD	LWORD	USINT	UINT	UDINT	ULINT	SINT	INT	DINT	LINT	REAL	LREAL	TIME	DATE	TOD	DT	STRING
In		●	●	●	●	●	●	●	●											
InPos							●													
InOutPos							●													
InOut		●	●	●	●	●	●	●	●											

Note:

The symbol ● indicates that the parameter is allowed to connect to the variable or constant of the data type.

Function Explanation

MoveBit moves one bit value from the bit position *InPos* in move source *In* to the bit position *InOutPos* in move destination *InOut*.

Precautions for Correct Use

- The instruction has no output but input.

- If the value of *InPos* exceeds the range of the data type of *In*, the movement of one bit is not performed.
- If the value of *InOutPos* exceeds the range of the data type of *InOut*, the movement of one bit is not performed.



Programming Example

■ **The variable table and program**

Variable name	Data type	Current value
MovBit_EN	BOOL	TRUE
MovBit_In	USINT	31
MovBit_Inpos	UINT	2
MovBit_InOutPos	UINT	3
MovBit_Inout	USINT	8

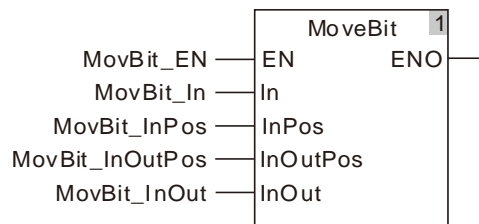

■ **Move Figure**

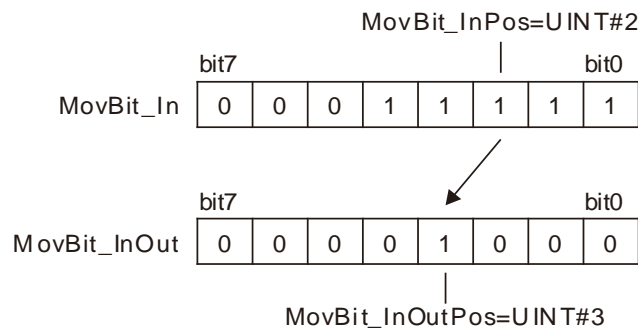

8.5.3 TransBit

FB/FC	Explanation	Applicable model
FC	TransBit is used for sending one or more bits in a bit string.	DVP15MC11T DVP15MC11T-06

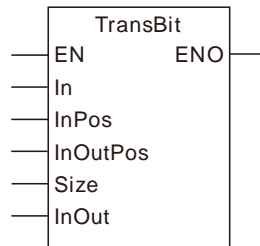

● Parameters

Parameter name	Meaning	Input/Output	Description	Valid range
In	Input signal	Input	Move source	Depends on the data type of the variable that the input parameter is connected to.
InPos	Input signal	Input	Move source bit	Depends on the data type of the variable that the input parameter is connected to.
InOutPos	Input signal	Input	Move destination bit	Depends on the data type of the variable that the input parameter is connected to.
Size	Input signal	Input	Number of bits to move	Depends on the data type of the variable that the input parameter is connected to.
InOut	Input signal	Input	Move destination	Depends on the data type of the variable that the input parameter is connected to.

	Boolean	Bit string				Integer							Real number		Time, date			String		
	BOOL	BYTE	WORD	DWORD	LWORD	USINT	UINT	UDINT	ULINT	SINT	INT	DINT	LINT	REAL	LREAL	TIME	DATE	TOD	DT	STRING
In		●	●	●	●	●	●	●	●											
InPos							●													
InOutPos							●													
Size							●													
InOut		●	●	●	●	●	●	●	●											

Note:

The symbol ● indicates that the parameter is allowed to connect to the variable or constant of the data type.

● Function Explanation

TransBit moves data of *Size* bits from the bit *InPos* in move source *In* to the bit *InOutPos* in move destination *InOut*.

● Precautions for Correct Use

- The instruction has no output but input.
- The movement can not be performed if the value of *Size* is 0.

- If the value of *InPos* exceeds the range of the data type of *In*, the movement is not performed.
- If the value of *InOutPos* exceeds the range of the data type of *InOut*, the movement is not performed.
- If the value of *Size* exceeds the range, the movement is not performed.

 **Programming Example**

■ **The variable table and program**

Variable name	Data type	Current value
TrsBit_EN	BOOL	TRUE
TrsBit_In	USINT	63
TrsBit_InPos	UINT	1
TrsBit_InOutPos	UINT	2
TrsBit_Size	UINT	2
TrsBit_Inout	USINT	12

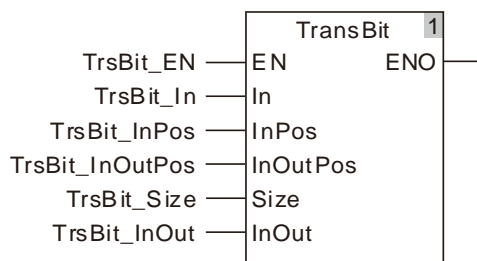

■ **Move Figure**

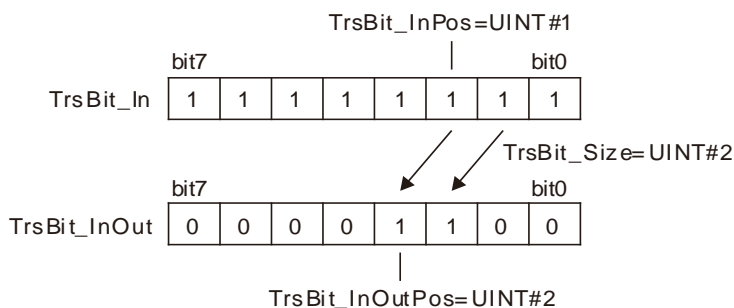

8.5.4 MoveDigit

FB/FC	Explanation	Applicable model
FC	MoveDigit is used for moving digits.	DVP15MC11T DVP15MC11T-06

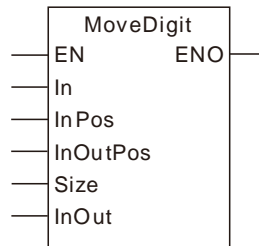

Parameters

Parameter name	Meaning	Input/Output	Description	Valid range
In	Input signal	Input	Move source	Depends on the data type of the variable that the input parameter is connected to.
InPos	Input signal	Input	Position of digit in <i>In</i> to move	Depends on the data type of the variable that the input parameter is connected to.
InOutPos	Input signal	Input	Position of digit in <i>Out</i> to receive the digit	Depends on the data type of the variable that the input parameter is connected to.
Size	Input signal	Input	Number of digits to move	Depends on the data type of the variable that the input parameter is connected to.
InOut	Input signal	Input	Move destination	Depends on the data type of the variable that the input parameter is connected to.

	Boolean	Bit string				Integer						Real number		Time, date			String			
	BOOL	BYTE	WORD	DWORD	LWORD	USINT	UINT	UDINT	ULINT	SINT	INT	DINT	LINT	REAL	LREAL	TIME	DATE	TOD	DT	STRING
In		●	●	●	●	●	●	●	●											
InPos							●													
InOutPos							●													
Size							●													
InOut		●	●	●	●	●	●	●	●											

Note:

The symbol ● indicates that the parameter is allowed to connect to the variable or constant of the data type.

Function Explanation

MoveDigit moves *Size* digits from *InPos* of move source *In* to *InOutPos* of move destination *InOut*.

Precautions for Correct Use

- The instruction has no output but input parameter.
- The move can not be performed if the value of *Size* is 0.
- If the value of *InPos* exceeds the range of the data type of *In*, the move will not be performed.

- If the value of *InOutPos* exceeds the range of the data type of *InOut*, the movement is not performed.
- If the value of *Size* exceeds the range, the movement is not performed.



Programming Example

■ **The variable table and program**

Variable name	Data type	Current value
MovDigt_EN	BOOL	TRUE
MovDigt_In	UDINT	16#1234
MovDigt_InPos	UINT	1
MovDigt_InOutPos	UINT	2
MovDigt_Size	UINT	2
MovDigt_Inout	UDINT	16#2300

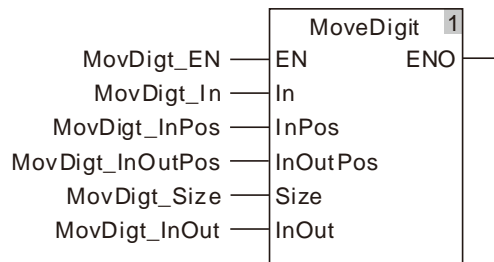

■ **Move Figure**

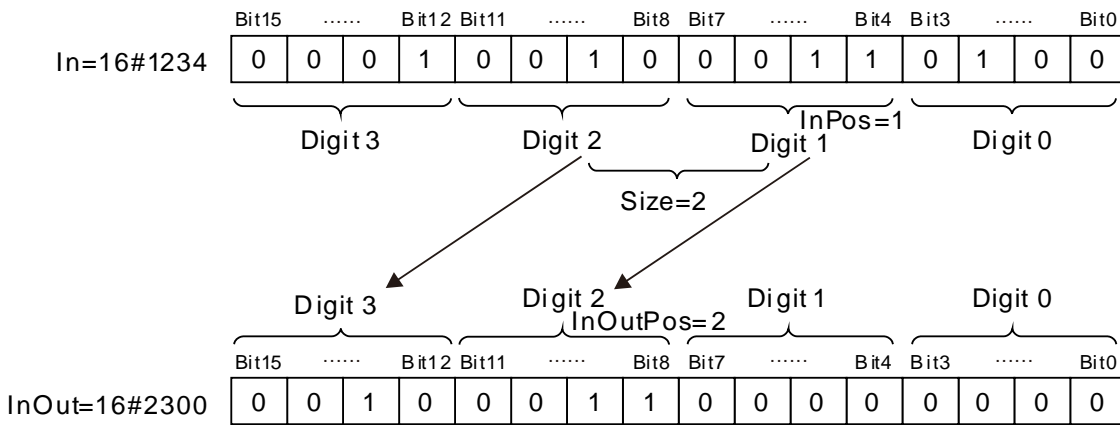

8.5.5 Exchange

FB/FC	Explanation	Applicable model
FC	Exchange is used for the data exchange.	DVP15MC11T DVP15MC11T-06

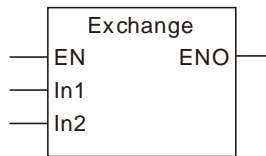

Parameters

Parameter name	Meaning	Input/Output	Description	Valid range
In1	Input signal	Input	Data to exchange	Depends on the data type of the variable that the input parameter is connected to.
In2	Input signal	Input	Data to exchange	Depends on the data type of the variable that the input parameter is connected to.

	Boolean	Bit string					Integer							Real number		Time, date			String	
	BOOL	BYTE	WORD	DWORD	LWORD	USINT	UINT	UDINT	ULINT	SINT	INT	DINT	LINT	REAL	LREAL	TIME	DATE	TOD	DT	STRING
In1	●	●	●	●	●	●	●	●	●	●	●	●	●	●	●	●	●	●	●	●
In2	●	●	●	●	●	●	●	●	●	●	●	●	●	●	●	●	●	●	●	●

Note:

The symbol ● indicates that the parameter is allowed to connect to the variable or constant of the data type.

Function Explanation

The Exchange instruction exchanges the values of *In1* and *In2*.

Precautions for Correct Use

- The data types of *In1* and *In2* must be same.
- The instruction has no output but two input parameters.



Programming Example

The variable table and program

Variable name	Data type	Current value
Exchg_EN	BOOL	TRUE
Exchg_In1	INT	30
Exchg_In2	INT	10

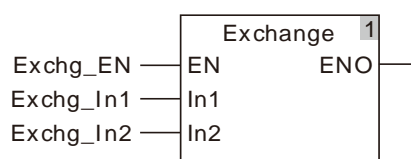

■ **Exchange Figure**

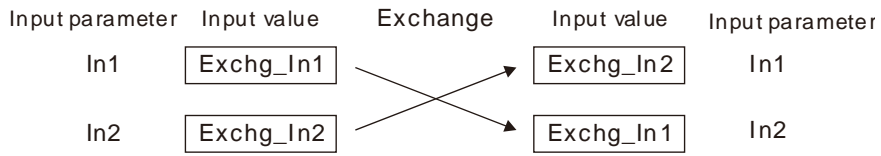

The values of In 1 and In2 are exchanged.

While the Exchange instruction is executed, the values of Exchg_In1 and Exchg_In2 are always exchanged.

8.5.6 Swap

FB/FC	Explanation	Applicable model
FC	Swap is used for swapping the high byte and low byte of a 16-bit value.	DVP15MC11T DVP15MC11T-06

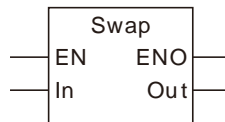

Parameters

Parameter name	Meaning	Input/Output	Description	Valid range
In	Input signal	Input	Data to swap	0~65535 for word data type
Out	Output signal	Output	Result	0~65535 for word data type

	Boolean	Bit string				Integer						Real number		Time, date			String			
	BOOL	BYTE	WORD	DWORD	LWORD	USINT	UINT	UDINT	ULINT	SINT	INT	DINT	LINT	REAL	LREAL	TIME	DATE	TOD	DT	STRING
In			●				●													
Out			●				●													

Note:

The symbol ● indicates that the parameter is allowed to connect to the variable or constant of the data type.

Function Explanation

The Swap instruction exchanges the high byte and low byte of the value of *In* and the result is output to *Out*.



Programming Example

The variable table and program

Variable name	Data type	Current value
Swap_EN	BOOL	TRUE
Swap_In	UINT	32768
Out1	UINT	128

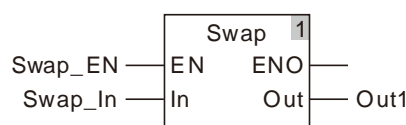

■ **Swap Figure**

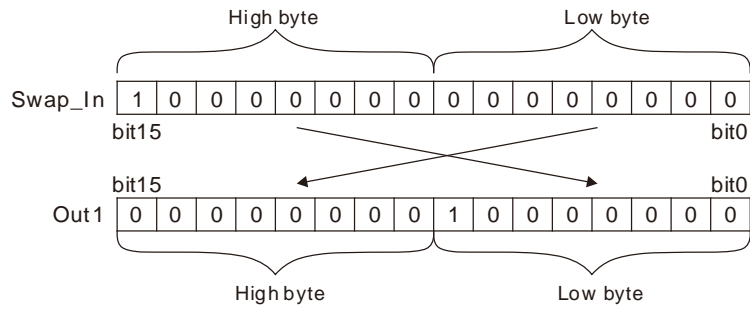

8.6 Comparison Instructions

8.6.1 LT

FB/FC	Explanation	Applicable model
FC	LT is used for a less-than comparison of two or more variables or constants.	DVP15MC11T DVP15MC11T-06

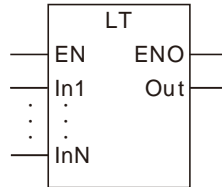

● Parameters

Parameter name	Meaning	Input/Output	Description	Valid range
In1 to InN	Comparison data	Input	The number of comparison data can be increased or decreased through the programming software. Maximum: 8. Minimum: 2. That is N=2~8.	Depends on the data type of the variable that the input parameter is connected to.
Out	Comparison result	Output	Comparison result	Depends on the data type of the variable that the output parameter is connected to.

	Boolean	Bit string					Integer							Real number		Time, date				String
	BOOL	BYTE	WORD	DWORD	LWORD	USINT	UINT	UDINT	ULINT	SINT	INT	DINT	LINT	REAL	LREAL	TIME	DATE	TOD	DT	STRING
In1 to InN	●	●	●	●	●	●	●	●	●	●	●	●	●	●	●	●	●	●	●	●
Out	●																			

Note:

The symbol ● indicates that the parameter is allowed to connect to the variable or constant of the data type.

● Function Explanation

- LT is used for a less-than comparison of two or more variables or constants. if $In1 < In2 < \dots < InN$, *Out* is TRUE. Otherwise, *Out* is FALSE.
- The input parameters $In1 \sim InN$ are allowed to be the variables of different data types in this instruction when the data types of input variables are not BOOL, TIME, DATE, TOD and STRING. When the data type of one input variable is one of BOOL, TIME, DATE, TOD and STRING, input parameters $In1 \sim InN$ are all required to be of the data type. For example, if the data type of $In1$ is TIME, the data type of $In2 \sim InN$ must be TIME. Otherwise, an error will occur in the compiling of the software.

● **Precautions for Correct Use**

- The input variables are not allowed to omit. An error will occur during the compiling of the software if any input variable is omitted. But the output variable is allowed to omit.
- The data type of output variables must be BOOL. Otherwise, an error will occur during the compiling of the software.



Programming Example

- **The data types of LT_In1, LT_In2 and LT_In3 are INT, UINT and DINT respectively and the data type of Out1 is BOOL.**

Out1 changes to TRUE when the values of LT_In1, LT_In2 and LT_In3 are -10, 50 and 100 respectively and LT_EN changes to TRUE as shown in Variable 1.

Out1 changes to FALSE when the values of LT_In1, LT_In2 and LT_In3 are 20, 10 and 100 respectively and LT_EN changes to TRUE as shown in Variable 2.

➤ **Variable 1**

Variable name	Data type	Current value
LT_EN	BOOL	TRUE
LT_In1	INT	-10
LT_In2	UINT	50
LT_In3	DINT	100
Out1	BOOL	TRUE

➤ **Variable 2**

Variable name	Data type	Current value
LT_EN	BOOL	TRUE
LT_In1	INT	20
LT_In2	UINT	10
LT_In3	DINT	100
Out1	BOOL	FALSE

➤ **The Program**

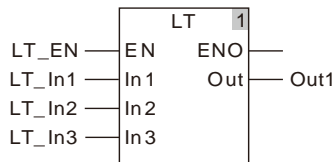

- **The data types of LT_In1 and LT_In2 are both TIME and the data type of Out1 is BOOL.**

Out1 changes to TRUE when the values of LT_In1 and LT_In2 are T#1ms and T#50ms respectively and LT_EN is TRUE.

➤ **The variable table and program**

Variable name	Data type	Current value
LT_EN	BOOL	TRUE
LT_In1	TIME	T#1ms
LT_In2	TIME	T#50ms
Out1	BOOL	TRUE

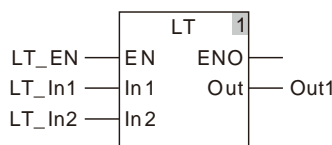

8.6.2 LE

FB/FC	Explanation	Applicable model
FC	LE is used for a less- than or equal comparison of two or more variables or constants.	DVP15MC11T DVP15MC11T-06

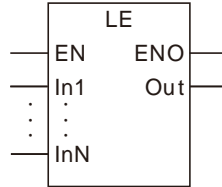

Parameters

Parameter name	Meaning	Input/Output	Description	Valid range
In1 to InN	Comparison data	Input	The number of comparison data can be increased or decreased through the programming software. Maximum: 8. Minimum: 2. That is N=2 ~ 8.	Depends on the data type of the variable that the input parameter is connected to.
Out	Comparison result	Output	Comparison result	Depends on the data type of the variable that the output parameter is connected to.

	Boolean	Bit string					Integer							Real number		Time, date				String
	BOOL	BYTE	WORD	DWORD	LWORD	USINT	UINT	UDINT	ULINT	SINT	INT	DINT	LINT	REAL	LREAL	TIME	DATE	TOD	DT	STRING
In1 to InN	●	●	●	●	●	●	●	●	●	●	●	●	●	●	●	●	●	●	●	●
Out	●																			

Note:

The symbol ● indicates that the parameter is allowed to connect to the variable or constant of the data type.

Function Explanation

- LE is used for a less than or equal comparison of two or more variables or constants. if $In1 \leq In2 \leq \dots \leq InN$, *Out* is TRUE. Otherwise, *Out* is FALSE.
- The input parameters *In1~InN* are allowed to be the variables of different data types in this instruction when the data types of input variables are not BOOL, TIME, DATE, TOD and STRING. When the data type of one input variable is one of BOOL, TIME, DATE, TOD and STRING, input parameters *In1~InN* are all required to be of the data type. For example, if the data type of *In1* is TIME, the data type of *In2~InN* must be TIME. Otherwise, an error will occur in the compiling of the software.

● **Precautions for Correct Use**

- The input variables are not allowed to omit. An error will occur during the compiling of the software if any input variable is omitted. But the output variable is allowed to omit.
- The data type of output variables must be BOOL. Otherwise, an error will occur during the compiling of the software.



Programming Example

- **The data types of LE_In1, LE_In2 and LE_In3 are INT, UINT and DINT respectively and the data type of Out1 is BOOL.**

Out1 changes to TRUE when the values of LE_In1, LE_In2 and LE_In3 are -10, 50 and 50 respectively and LE_EN changes to TRUE as shown in Variable 1.

Out1 changes to FALSE when the values of LE_In1, LE_In2 and LE_In3 are 20, 10 and 100 respectively and LE_EN changes to TRUE as shown in Variable 2.

➤ **Variable 1**

Variable name	Data type	Current value
LE_EN	BOOL	TRUE
LE_In1	INT	-10
LE_In2	UINT	50
LE_In3	DINT	50
Out1	BOOL	TRUE

➤ **Variable 2**

Variable name	Data type	Current value
LE_EN	BOOL	TRUE
LE_In1	INT	20
LE_In2	UINT	10
LE_In3	DINT	100
Out1	BOOL	FALSE

➤ **The Program**

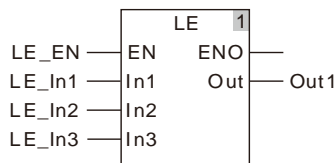

- **The data types of LE_In1 and LE_In2 are both TIME and the data type of Out1 is BOOL.**

Out1 changes to TRUE when the values of LE_In1 and LE_In2 are T#1ms and T#50ms respectively and LE_EN is TRUE.

➤ **The variable table and program**

Variable name	Data type	Current value
LE_EN	BOOL	TRUE
LE_In1	TIME	T#1ms
LE_In2	TIME	T#50ms
Out1	BOOL	TRUE

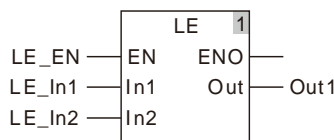

8.6.3 GT

FB/FC	Explanation	Applicable model
FC	GT is used for a greater-than comparison of two or more variables or constants.	DVP15MC11T DVP15MC11T-06

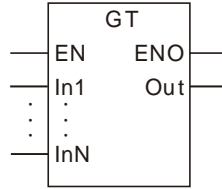

● Parameters

Parameter name	Meaning	Input/Output	Description	Valid range
In1 to InN	Comparison data	Input	The number of comparison data can be increased or decreased through the programming software. Maximum: 8. Minimum: 2. That is N=2 ~ 8.	Depends on the data type of the variable that the input parameter is connected to.
Out	Comparison result	Output	Comparison result	Depends on the data type of the variable that the output parameter is connected to.

	Boolean	Bit string					Integer							Real number		Time, date				String
	BOOL	BYTE	WORD	DWORD	LWORD	USINT	UINT	UDINT	ULINT	SINT	INT	DINT	LINT	REAL	LREAL	TIME	DATE	TOD	DT	STRING
In1 to InN	●	●	●	●	●	●	●	●	●	●	●	●	●	●	●	●	●	●	●	●
Out	●																			

Note:

The symbol ● indicates that the parameter is allowed to connect to the variable or constant of the data type.

● Function Explanation

- LE is used for a greater than comparison of two or more variables or constants. if $In1 > In2 > \dots > InN$, *Out* is TRUE. Otherwise, *Out* is FALSE.
- The input parameters $In1 \sim InN$ are allowed to be the variables of different data types in this instruction when the data types of input variables are not BOOL, TIME, DATE, TOD and STRING. When the data type of one input variable is one of BOOL, TIME, DATE, TOD and STRING, input parameters $In1 \sim InN$ are all required to be of the data type. For example, if the data type of $In1$ is TIME, the data type of $In2 \sim InN$ must be TIME. Otherwise, an error will occur in the compiling of the software.

● **Precautions for Correct Use**

- The input variables are not allowed to omit. An error will occur during the compiling of the software if any input variable is omitted. But the output variable is allowed to omit.
- The data type of output variables must be BOOL. Otherwise, an error will occur during the compiling of the software.



Programming Example

- **The data types of GT_In1, GT_In2 and GT_In3 are INT, UINT and DINT respectively and the data type of Out1 is BOOL.**

Out1 changes to TRUE when the values of GT_In1, GT_In2 and GT_In3 are 100, 50 and 10 respectively and GT_EN changes to TRUE as shown in Variable 1.

Out1 changes to FALSE when the values of GT_In1, GT_In2 and GT_In3 are 20, 10 and 100 respectively and GT_EN changes to TRUE as shown in Variable 2.

➤ **Variable 1**

Variable name	Data type	Current value
GT_EN	BOOL	TRUE
GT_In1	INT	100
GT_In2	UINT	50
GT_In3	DINT	10
Out1	BOOL	TRUE

➤ **Variable 2**

Variable name	Data type	Current value
GT_EN	BOOL	TRUE
GT_In1	INT	20
GT_In2	UINT	10
GT_In3	DINT	100
Out1	BOOL	FALSE

➤ **The Program**

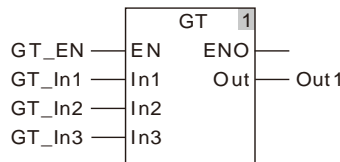

- **The data types of GT_In1 and GT_In2 are both TIME and the data type of Out1 is BOOL.**

Out1 changes to TRUE when the values of GT_In1 and GT_In2 are T#100ms and T#50ms respectively and GT_EN changes to TRUE.

➤ **The variable table and program**

Variable name	Data type	Current value
GT_EN	BOOL	TRUE
GT_In1	TIME	T#100ms
GT_In2	TIME	T#50ms
Out1	BOOL	TRUE

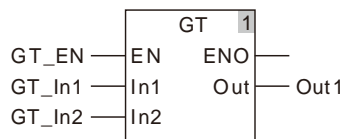

8.6.4 GE

FB/FC	Explanation	Applicable model
FC	GE is used for a greater- than or equal comparison of two or more variables or constants.	DVP15MC11T DVP15MC11T-06

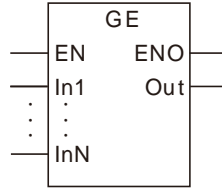

● Parameters

Parameter name	Meaning	Input/Output	Description	Valid range
In1 to InN	Comparison data	Input	The number of comparison data can be increased or decreased through the programming software. Maximum: 8. Minimum: 2. That is N=2 ~ 8.	Depends on the data type of the variable that the input parameter is connected to.
Out	Comparison result	Output	Comparison result	Depends on the data type of the variable that the output parameter is connected to.

	Boolean	Bit string					Integer							Real number		Time, date				String
	BOOL	BYTE	WORD	DWORD	LWORD	USINT	UINT	UDINT	ULINT	SINT	INT	DINT	LINT	REAL	LREAL	TIME	DATE	TOD	DT	STRING
In1 to InN	●	●	●	●	●	●	●	●	●	●	●	●	●	●	●	●	●	●	●	●
Out	●																			

Note:

The symbol ● indicates that the parameter is allowed to connect to the variable or constant of the data type.

● Function Explanation

- GE is used for a greater than or equal comparison of two or more variables or constants. if $In1 \geq In2 \geq \dots \geq InN$, *Out* is TRUE. Otherwise, *Out* is FALSE.
- The input parameters *In1~InN* are allowed to be the variables of different data types in this instruction when the data types of input variables are not BOOL, TIME, DATE, TOD and STRING. When the data type of one input variable is one of BOOL, TIME, DATE, TOD and STRING, input parameters *In1~InN* are all required to be of the data type. For example, if the data type of *In1* is TIME, the data type of *In2~InN* must be TIME. Otherwise, an error will occur in the compiling of the software.

● **Precautions for Correct Use**

- The input variables are not allowed to omit. An error will occur during the compiling of the software if any input variable is omitted. But the output variable is allowed to omit.
- The data type of output variables must be BOOL. Otherwise, an error will occur during the compiling of the software.



Programming Example

- **The data types of GE_In1, GE_In2 and GE_In3 are INT, UINT and DINT respectively and the data type of Out1 is BOOL.**

Out1 changes to TRUE when the values of GE_In1, GE_In2 and GE_In3 are 100, 50 and 50 respectively and GE_EN changes to TRUE as shown in Variable 1.

Out1 changes to FALSE when the values of GE_In1, GE_In2 and GE_In3 are 10, 10 and 100 respectively and GE_EN changes to TRUE as shown in Variable 2.

➤ **Variable 1**

Variable name	Data type	Current value
GE_EN	BOOL	TRUE
GE_In1	INT	100
GE_In2	UINT	50
GE_In3	DINT	50
Out1	BOOL	TRUE

➤ **Variable 2**

Variable name	Data type	Current value
GE_EN	BOOL	TRUE
GE_In1	INT	10
GE_In2	UINT	10
GE_In3	DINT	100
Out1	BOOL	FALSE

➤ **The program**

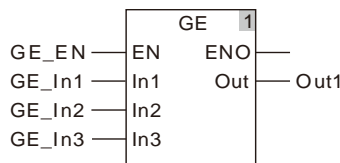

- **The data types of GE_In1 and GE_In2 are both TIME and the data type of Out1 is BOOL.**

Out1 changes to TRUE when the values of GE_In1 and GE_In2 are T#100ms and T#50ms respectively and GE_EN changes to TRUE.

➤ **The variable table and program**

Variable name	Data type	Current value
GE_EN	BOOL	TRUE
GE_In1	TIME	T#100ms
GE_In2	TIME	T#50ms
Out1	BOOL	TRUE

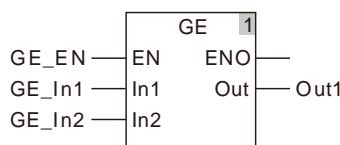

8.6.5 EQ

FB/FC	Explanation	Applicable model
FC	EQ is used for an equal comparison of two or more variables and constants.	DVP15MC11T DVP15MC11T-06

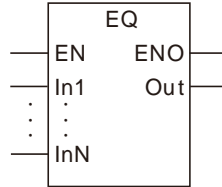

● Parameters

Parameter name	Meaning	Input/Output	Description	Valid range
In1 to InN	Comparison data	Input	The number of comparison data can be increased or decreased through the programming software. Maximum: 8. Minimum: 2. That is N=2 ~ 8.	Depends on the data type of the variable that the input parameter is connected to.
Out	Comparison result	Output	Comparison result	Depends on the data type of the variable that the output parameter is connected to.

	Boolean	Bit string					Integer							Real number		Time, date				String
	BOOL	BYTE	WORD	DWORD	LWORD	USINT	UINT	UDINT	ULINT	SINT	INT	DINT	LINT	REAL	LREAL	TIME	DATE	TOD	DT	STRING
In1 to InN	●	●	●	●	●	●	●	●	●	●	●	●	●	●	●	●	●	●	●	●
Out	●																			

Note:

The symbol ● indicates that the parameter is allowed to connect to the variable or constant of the data type.

● Function Explanation

- EQ is used for an equal comparison of two or more variables and constants. If $In1 = In2 = \dots = InN$, *Out* is TRUE. Otherwise, *Out* is FALSE.
- The input parameters $In1 \sim InN$ are allowed to be the variables of different data types in this instruction when the data types of input variables are not BOOL, TIME, DATE, TOD and STRING. When the data type of one input variable is one of BOOL, TIME, DATE, TOD and STRING, input parameters $In1 \sim InN$ are all required to be of the data type. For example, if the data type of $In1$ is TIME, the data type of $In2 \sim InN$ must be TIME. Otherwise, an error will occur in the compiling of the software.

● **Precautions for Correct Use**

- The input variables are not allowed to omit. An error will occur during the compiling of the software if any input variable is omitted. But the output variable is allowed to omit.
- The data type of output variables must be BOOL. Otherwise, an error will occur during the compiling of the software.



Programming Example

- **The data types of EQ_In1, EQ_In2 and EQ_In3 are INT, UINT and DINT respectively and the data type of Out1 is BOOL.**

Out1 changes to TRUE when the values of EQ_In1, EQ_In2 and EQ_In3 are 50, 50 and 50 respectively and EQ_EN changes to TRUE as shown in Variable 1.

Out1 changes to FALSE when the values of EQ_In1, EQ_In2 and EQ_In3 are 10, 50 and 100 respectively and EQ_EN changes to TRUE as shown in Variable 2.

➤ **Variable 1**

Variable name	Data type	Current value
EQ_EN	BOOL	TRUE
EQ_In1	INT	50
EQ_In2	UINT	50
EQ_In3	DINT	50
Out1	BOOL	TRUE

➤ **Variable 2**

Variable name	Data type	Current value
EQ_EN	BOOL	TRUE
EQ_In1	INT	10
EQ_In2	UINT	50
EQ_In3	DINT	100
Out1	BOOL	FALSE

➤ **The Program**

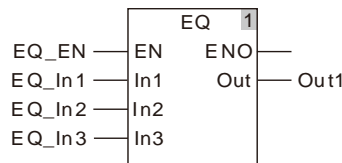

- **The data types of EQ_In1 and EQ_In2 are both TIME and the data type of Out1 is BOOL.**

Out1 changes to TRUE when the values of EQ_In1 and EQ_In2 are T#50ms and T#50ms respectively and EQ_EN changes to TRUE.

➤ **The variable table and program**

Variable name	Data type	Current value
EQ_EN	BOOL	TRUE
EQ_In1	TIME	T#50ms
EQ_In2	TIME	T#50ms
Out1	BOOL	TRUE

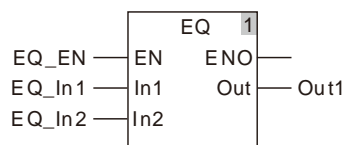

8.6.6 NE

FB/FC	Explanation	Applicable model
FC	NE is used for a not-equal comparison of two variables or constants.	DVP15MC11T DVP15MC11T-06

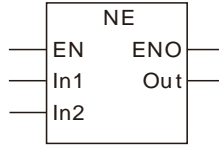

● Parameters

Parameter name	Meaning	Input/Output	Description	Valid range
In1	Comparison data	Input	A value to compare	Depends on the data type of the variable that the input parameter is connected to.
In2	Comparison data	Input	A value to compare	Depends on the data type of the variable that the input parameter is connected to.
Out	Comparison result	Output	Comparison result	Depends on the data type of the variable that the output parameter is connected to.

	Boolean	Bit string					Integer							Real number		Time, date				String
	BOOL	BYTE	WORD	DWORD	LWORD	USINT	UINT	UDINT	ULINT	SINT	INT	DINT	LINT	REAL	LREAL	TIME	DATE	TOD	DT	STRING
In1 and In2	●	●	●	●	●	●	●	●	●	●	●	●	●	●	●	●	●	●	●	●
Out	●																			

Note:

The symbol ● indicates that the parameter is allowed to connect to the variable or constant of the data type.

● Function Explanation

- NE is used for a not-equal comparison of two variables and constants. *Out* is TRUE if $In1 \neq In2$. Otherwise, *Out* is FALSE.
- The input parameters *In1* and *In2* are allowed to be the variables of different data types in this instruction when the data types of input variables are not BOOL, TIME, DATE, TOD and STRING. When the data type of one input variable is one of BOOL, TIME, DATE, TOD and STRING, input parameters *In1* and *In2* are both required to be of the data type. For example, if the data type of *In1* is TIME, the data type of *In2* must be TIME. Otherwise, an error will occur in the compiling of the software.

● Precautions for Correct Use

- The input variables are not allowed to omit. An error will occur during the compiling of the software if any input variable is omitted. But the output variable is allowed to omit.
- The data type of output variables must be BOOL. Otherwise, an error will occur during the compiling of the software.

Programming Example

- **The data types of NE_In1 and NE_In2 are INT and DINT respectively and the data type of Out1 is BOOL.**

Out1 changes to TRUE when the values of NE_In1 and NE_In2 are 100 and 50 respectively and NE_EN changes to TRUE as shown in Variable 1.

Out1 changes to FALSE when the values of NE_In1 and NE_In2 are 100 and 100 respectively and NE_EN changes to TRUE as shown in Variable 2.

➤ **Variable 1**

Variable name	Data type	Current value
NE_EN	BOOL	TRUE
NE_In1	INT	100
NE_In2	UINT	50
Out1	BOOL	TRUE

➤ **Variable 2**

Variable name	Data type	Current value
NE_EN	BOOL	TRUE
NE_In1	INT	100
NE_In2	UINT	100
Out1	BOOL	FALSE

➤ **The Program**

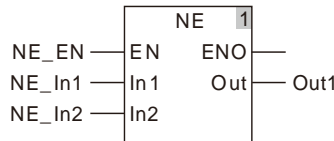

- **The data types of NE_In1 and NE_In2 are both TIME and the data type of Out1 is BOOL.**

Out1 changes to TRUE when the values of NE_In1 and NE_In2 are T#10ms and T#50ms respectively and NE_EN changes to TRUE.

➤ **The variable table and program**

Variable name	Data type	Current value
NE_EN	BOOL	TRUE
NE_In1	TIME	T#10ms
NE_In2	TIME	T#50ms
Out1	BOOL	TRUE

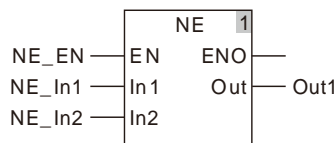

8.7 Timer Instructions

8.7.1 TON

FB/FC	Explanation	Applicable model
FB	TON is used for the ON delay.	DVP15MC11T DVP15MC11T-06

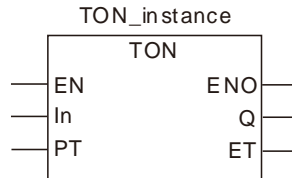

● Parameters

Parameter name	Meaning	Input/Output	Description	Valid range
In	Timer input	Input	Controls the timer to start or reset	TRUE or FALSE
PT	Set time	Input	Time from when the timer starts until Q changes to TRUE.	
Q	Timer output	Output	Q is TRUE when the set time <i>PT</i> is reached.	TRUE or FALSE
ET	Elapsed time	Output	Elapsed time from the time when the timer starts to current time.	

◆ T#0ms ~ 213503d23h34m33s709.551ms

	Boolean	Bit string				Integer							Real number		Time, date				String		
	BOOL	BYTE	WORD	DWORD	LWORD	USINT	UINT	UDINT	ULINT	SINT	INT	DINT	LINT	REAL	LREAL	TIME	DATE	TOD	DT	STRING	
In	●																				
PT																●					
Q	●																				
ET																●					

Note:

The symbol ● indicates that the parameter is allowed to connect to the variable or constant of the data type.

● Function Explanation

- The TON instruction is defined as the function of a timer for the ON delay.
- When *In* is TRUE, the timer starts to measure the time and the value of *ET* increases accordingly. When *ET* equals *PT*, *Q* is TRUE. When *In* is set to FALSE, the measuring of the time stops and *Q* and *ET* are both reset.

● Precautions for Correct Use

When the output value of *ET* reaches the set value of *PT*, the timer stops measuring time. *ET* is reset to 0 (0ms) when *In* changes from TRUE to FALSE.

Programming Example

■ **The variable table and program**

Variable name	Data type	Initial value
TON1	TON	
TON1_EN	BOOL	FALSE
TON1_In	BOOL	FALSE
TON1_PT	TIME	
TON1_Q	BOOL	
TON1_ET	TIME	

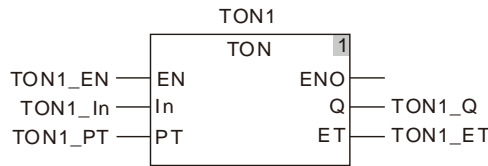

■ **Timing Chart:**

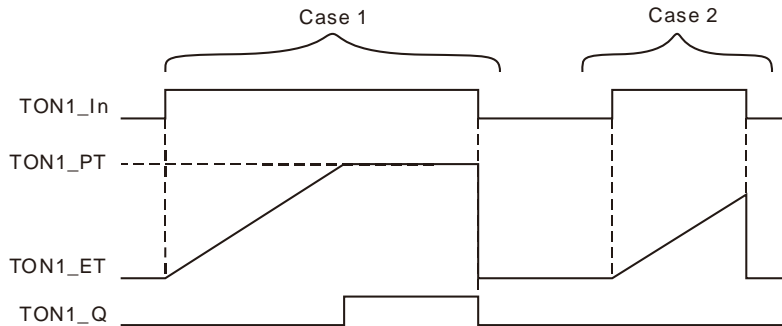

Case 1 : TON1_PT is the set time. When TON1_In is TRUE, the timer starts to measure the time. When the value of TON1_ET equals the setting value of TON1_PT, TON1_Q is TRUE. When the timer stops measuring time, TON1_In is reset to FALSE and TON1_ET and TON1_Q are both reset.

Case 2 : When the currently measured time of the timer TON1_ET is less than the set time TON1_PT and TON1_In is reset to FALSE, TON1_ET is reset and the state of TON1_Q does not change.

8.7.2 TOF

FB/FC	Explanation	Applicable model
FB	TOF is used for the off delay.	DVP15MC11T DVP15MC11T-06

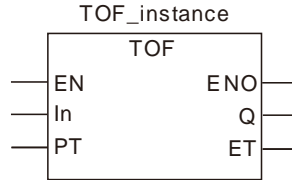

Parameters

Parameter name	Meaning	Input/Output	Description	Valid range
In	Timer input	Input	Controls the timer to start or reset	TRUE or FALSE
PT	Set time	Input	Set the time from when the timer starts until Q changes to TRUE	
Q	Timer output	Output	Q is FALSE when the set time <i>PT</i> is reached.	TRUE or FALSE
ET	Elapsed time	Output	Elapsed time from the time when the timer starts to current time.	

◆ T#0ms ~ 213503d23h34m33s709.551ms

	Boolean	Bit string					Integer						Real number		Time, date				String		
	BOOL	BYTE	WORD	DWORD	LWORD	USINT	UINT	UDINT	ULINT	SINT	INT	DINT	LINT	REAL	LREAL	TIME	DATE	TOD	DT	STRING	
In	●																				
PT																●					
Q	●																				
ET																●					

Note:

The symbol ● indicates that the parameter is allowed to connect to the variable or constant of the data type.

Function Explanation

- The TOF instruction is defined as the function of a timer for the OFF delay.
- When *In* is TRUE, Q is TRUE. When *In* changes from TRUE to FALSE, the timer starts to measure the time and the value of *ET* increases accordingly. At the moment, Q remains TRUE. When *ET* equals *PT*, Q is FALSE and the timer stops measuring time. When *In* is set to TRUE, *ET* is reset and Q changes to TRUE again.

Precautions for Correct Use

When the output value of *ET* reaches the set value of *PT*, the timer stops measuring time. *ET* is reset to 0 (0ms) when *In* changes from FALSE to TRUE.

Programming Example

■ **The variable table and program**

Variable name	Data type	Initial value
TOF1	TOF	
TOF1_EN	BOOL	FALSE
TOF1_In	BOOL	FALSE
TOF1_PT	TIME	
TOF1_Q	BOOL	
TOF1_ET	TIME	

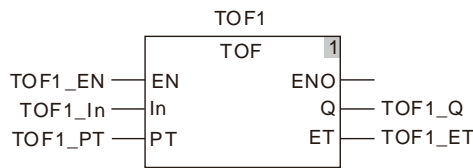

■ **Timing Chart:**

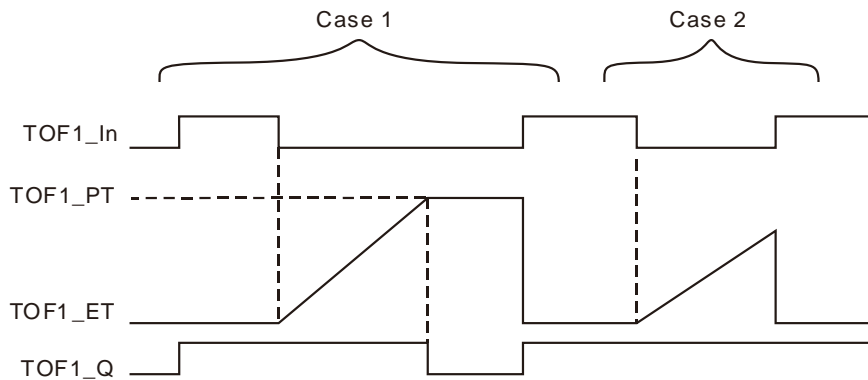

- Case 1 :** TOF1_PT is the set time for off delay. When TOF1_In is TRUE, TOF1_Q is TRUE. When TOF1_In is FALSE, the timer starts to measure the time. When the value of TOF1_ET equals the setting value of TOF1_PT, TOF1_Q is FALSE and the timer stops timing.
- Case 3 :** When TOF1_In changes from TRUE to FALSE, the timer starts timing. When current time (TOF1_ET) is less than the set time (TOF1_PT) and TOF1_In is set to TRUE, TOF1_ET is reset and the state of TOF1_Q does not change.

8.7.3 TP

FB/FC	Explanation	Applicable model
FB	TP is used for the off delay after the input <i>In</i> is TRUE.	DVP15MC11T DVP15MC11T-06

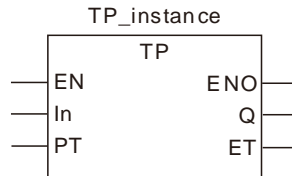

● Parameters

Parameter name	Meaning	Input/Output	Description	Valid range
In	Timer input	Input	Controls the timer to start or reset	TRUE or FALSE
PT	Set time	Input	Set the time from when the timer starts until Q changes to TRUE	◆
Q	Timer output	Output	Q is FALSE when the set time <i>PT</i> is reached.	TRUE or FALSE
ET	Elapsed time	Output	Elapsed time from the time when the timer starts to current time.	◆

◆ T#0ms ~ 213503d23h34m33s709.551ms

	Boolean	Bit string				Integer							Real number		Time, date			String			
	BOOL	BYTE	WORD	DWORD	LWORD	USINT	UINT	UDINT	ULINT	SINT	INT	DINT	LINT	REAL	LREAL	TIME	DATE	TOD	DT	STRING	
In	●																				
PT																●					
Q	●																				
ET																●					

Note:

The symbol ● indicates that the parameter is allowed to connect to the variable or constant of the data type.

● Function Explanation

When *In* is TRUE, Q is TRUE and the timer starts measuring time and the value of *ET* increases accordingly. At the moment, Q remains TRUE. When *ET* equals *PT*, Q is FALSE and the timer stops measuring time. When *In* changes from TRUE to FALSE, ET is reset.

● Precautions for Correct Use

When the output value of *ET* reaches the set value of *PT*, the timer stops measuring time. *ET* is reset to 0 (0ms) when *In* changes from TRUE to FALSE.

Programming Example

The variable table and program

Variable name	Data type	Initial value
TP1	TP	
TP1_EN	BOOL	FALSE
TP1_In	BOOL	FALSE
TP1_PT	TIME	
TP1_Q	BOOL	
TP1_ET	TIME	

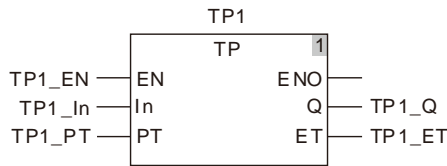

Timing Chart:

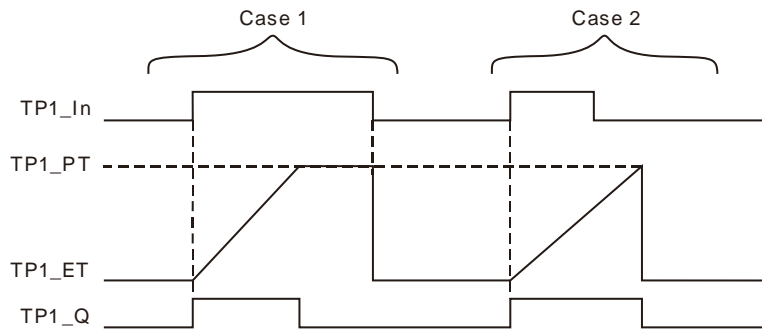

Case 1 : TP1_PT sets the time for off delay. When TP1_In is TRUE, the timer starts to measure time and TP1_Q is TRUE. When the value of TP1_ET equals the setting value of TP1_PT, TP1_Q is FALSE. When TP1_In is FALSE, TP1_ET is reset.

Case 2 : TP1_PT sets the time for off delay. When TP1_In is TRUE and the timer starts to measure time, TP1_Q is TRUE. When TP1_In is FALSE and the value of TP1_ET is less than the setting value of TP1_PT, TP1_ET keeps timing and TP1_Q keeps TRUE state. When the value of TP1_ET equals the setting value of TP1_PT, TP1_ET and TP1_Q are both reset.

8.7.4 Sys_ReadTime

FB/FC	Explanation	Applicable model
FB	Sys_ReadTime reads the time of the real-time clock of the controller.	DVP15MC11T DVP15MC11T-06

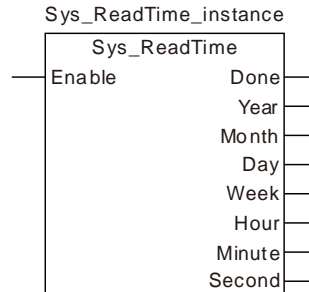

● Input Parameter

Parameter name	Function	Data type	Valid range (Default)	Validation timing
Enable	The instruction is executed when <i>Enable</i> changes from FALSE to TRUE.	BOOL	TRUE or FALSE (FALSE)	When <i>Enable</i> is TRUE.

● Output Parameters

Parameter name	Function	Data type	Valid range
Done	TRUE when the instruction execution is completed.	BOOL	TRUE/FALSE
Year	Year	UINT	1970~2106
Month	Month	UINT	1~12
Day	Day	UINT	1~31
Week	Week	UINT	1~7
Hour	Hour	UINT	0~23
Minute	Minute	UINT	0~59
Second	Second	UINT	0~59

● Function Explanation

Sys_ReadTime reads the time of the real-time clock of the controller. When *Enable* is TRUE, the real-time clock information in the controller such as year, month, day, week, hour, minute and second will be read in the specified variables.

8.7.5 Sys_ReadTotalWorkTime

FB/FC	Explanation	Applicable model
FB	Sys_ReadTotalWorkTime reads total work time of the controller.	DVP15MC11T DVP15MC11T-06

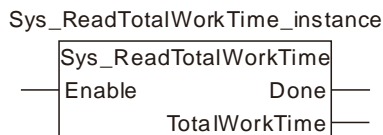

● Input Parameter

Parameter name	Function	Data type	Valid range (Default)	Validation timing
Enable	The instruction is executed when <i>Enable</i> changes from FALSE to TRUE.	BOOL	TRUE or FALSE (FALSE)	When <i>Enable</i> is TRUE.

● Output Parameters

Parameter name	Function	Data type	Valid range
Done	TRUE when the instruction execution is completed.	BOOL	TRUE/FALSE
TotalWorkTime	Shows total work time of the controller.	TIME	

◆ T#0ms ~ 213503d23h34m33s709.551ms

● Function Explanation

Sys_ReadTotalWorkTime reads total work time of the controller. When *Enable* is TRUE, the total work time of the controller is read in the variable specified by *TotalWorkTime*. For example, the controller worked for 3 hours yesterday and worked for 2 hours today. So the read total work time of the controller is 5 hours.

8.7.6 Sys_ReadPowerOnTime

FB/FC	Explanation	Applicable model
FB	Sys_ReadPowerOnTime reads power-on time of the controller.	DVP15MC11T DVP15MC11T-06

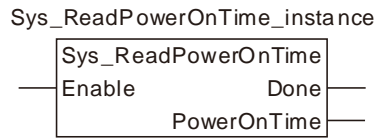

● Input Parameter

Parameter name	Function	Data type	Valid range (Default)	Validation timing
Enable	The instruction is executed when <i>Enable</i> changes from FALSE to TRUE.	BOOL	TRUE or FALSE (FALSE)	When <i>Enable</i> is TRUE.

● Output Parameters

Parameter name	Function	Data type	Valid range
Done	TRUE when the instruction execution is completed.	BOOL	TRUE/FALSE
PowerOnTime	Shows total power-on time of the controller.	TIME	

◆ T#0ms ~ 213503d23h34m33s709.551ms

● Function Explanation

Sys_ReadPowerOnTime reads total power-on time of the controller. The instruction will restart to measure the power-on time if the controller is repowered after power off. When *Enable* is TRUE, the total power-on time of the controller will be read in the variable specified by *PowerOnTime*.

8.7.7 Sys_WdgStatus

FB/FC	Explanation	Applicable model
FB	The Sys_WdgStatus instruction is used to read whether or not the execution time of the specified task exceeds the allowed setting time (watchdog time).	DVP15MC11T DVP15MC11T-06

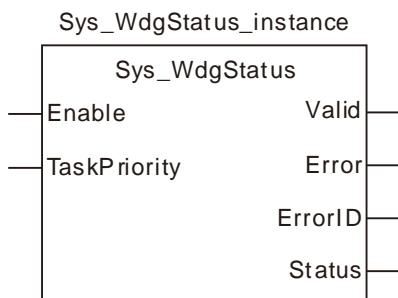

● Input Parameters

Parameter name	Function	Data type	Valid range (Default)	Validation timing
Enable	The instruction is executed when <i>Enable</i> changes from FALSE to TRUE.	BOOL	TRUE or FALSE (FALSE)	When <i>Enable</i> changes to TRUE
TaskPriority	Set the priority of a task, i.e. to specify the task via its priority.	UINT	1~24 (0)	When <i>Enable</i> changes to TRUE

● Output Parameters

Parameter name	Function	Data type	Valid range
Valid	TRUE when the output of the instruction is valid.	BOOL	TRUE / FALSE
Error	TRUE when an error occurs in the instruction execution.	BOOL	TRUE / FALSE
ErrorID	Contains the error code when an error occurs. Please refer to section 12.2 for the corresponding error ID.	WORD	
Status	TRUE when the execution time of the specified task exceeds the allowed setting time (watchdog time).	BOOL	TRUE / FALSE

● Output Update Timing

Parameter Name	Timing for changing to TRUE	Timing for changing to FALSE
Valid	◆ When <i>Enable</i> changes to TRUE	◆ When <i>Enable</i> changes from TRUE to FALSE. ◆ When <i>Error</i> changes from FALSE to TRUE.
Error	◆ When the input parameters for the instruction are illegal.	◆ When <i>Enable</i> changes from TRUE to FALSE
Status	◆ When the execution time of the specified task exceeds the allowed setting time (watchdog time).	◆ When the execution time of the specified task does not exceed the allowed setting time (watchdog time).

● Output Update Timing Chart

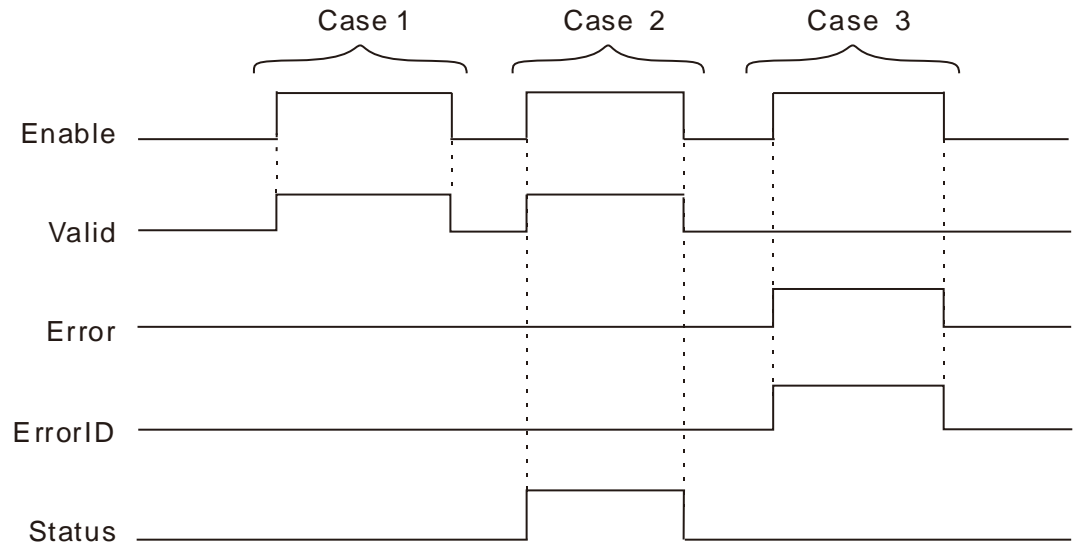

Case 1 : *Valid* changes from FALSE to TRUE when *Enable* changes from FALSE to TRUE.

Case 2 : *Valid* changes from FALSE to TRUE when *Enable* changes from FALSE to TRUE. When the task execution time exceeds the watchdog time, *Status* changes to TRUE. When *Enable* changes from TRUE to FALSE, *Valid* changes to FALSE and *Status* changes to FALSE.

Case 3 : When an error occurs as *Enable* changes from FALSE to TRUE, *Error* changes to TRUE and *ErrorID* shows corresponding error codes. When *Enable* changes from TRUE to FALSE, *Error* changes to FALSE.

- **Function**

The Sys_WdgStatus instruction is used to read whether or not the execution time of the specified task exceeds the allowed setting time (watchdog time). When this instruction is used, do not place it in the task specified by *TaskPriority*. It should be placed in other different task for execution.

The *Status* output of the instruction changes from FALSE to TRUE, the execution of the task specified by *TaskPriority* stops. *Status* of the instruction can be used to perform related operation in other task by users.

8.8 Counter Instructions

8.8.1 CTU

FB/FC	Explanation	Applicable model
FB	CTU is used as an up counter.	DVP15MC11T DVP15MC11T-06

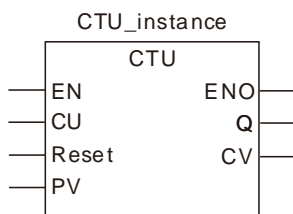

● **Parameters**

Parameter name	Meaning	Input/Output	Description	Valid range
CU	Up-counter input signal	Input	Control the up-counter to start counting up	TRUE or FALSE
Reset	Reset signal	Input	Reset the counter present value	TRUE or FALSE
PV	Preset value	Input	Counter setting value	0 ~ 4294967295
Q	Output signal	Output	Q is TRUE when CV equals PV.	TRUE or FALSE
CV	Counter value	Output	Counter present value	0 ~ 4294967295

	Boolean	Bit string					Integer						Real number		Time, date			String		
	BOOL	BYTE	WORD	DWORD	LWORD	USINT	UINT	UDINT	ULINT	SINT	INT	DINT	LINT	REAL	LREAL	TIME	DATE	TOD	DT	STRING
CU	●																			
Reset	●																			
PV								●												
Q	●																			
CV								●												

Note:

The symbol ● indicates that the parameter is allowed to connect to the variable or constant of the data type.

● **Function Explanation**

1. CTU functions as an up counter.
2. When *CU* changes from FALSE to TRUE, the counter performs the up-counting once and the value of *CV* is increased by 1. When *CV* equals *PV*, *Q* is TRUE. When *Reset* is set to TRUE, *CV* is cleared to 0 and *Q* is reset to FALSE.

- **Precautions for Correct Use**

- While *Reset* is TRUE, the counter will not count up.
- When CV equals PV, the counter stops counting.



- **Programming Example**

- **The variable table and program**

Variable name	Data type	Initial value
CTU1	CTU	
CTU1_EN	BOOL	FALSE
CTU1_CU	BOOL	FALSE
CTU1_Reset	BOOL	FALSE
CTU1_PV	UDINT	4
CTU1_Q	BOOL	
CTU1_CV	UDINT	

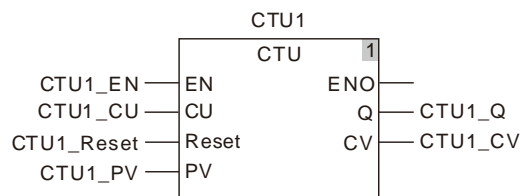

- **Timing Chart:**

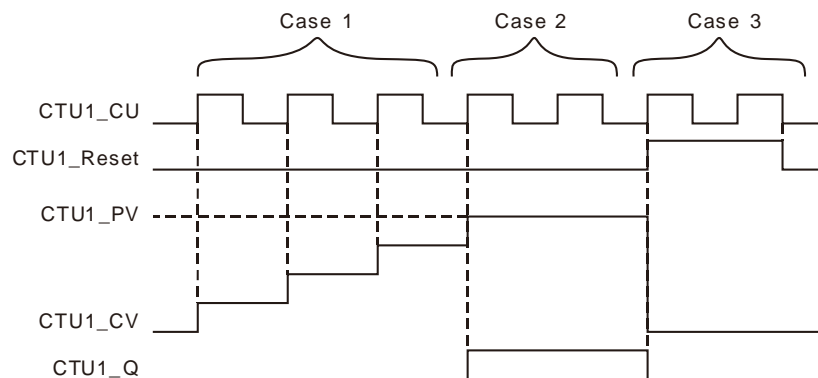

Case 1 : If CTU counts up normally, the value of CTU1_CV is increased by 1 whenever CTU1_CU is triggered once.

Case 2 : When CTU1_CV equals CTU1_PV, CTU1_Q is TRUE and CTU stops counting.

Case 3 : When CTU1_Reset is TRUE, CTU1_CV is cleared to 0, CTU1_Q is FALSE. And the counter will not count when CTU1_CU is triggered.

8.8.2 CTD

FB/FC	Explanation	Applicable model
FB	CTD is used as a down counter.	DVP15MC11T DVP15MC11T-06

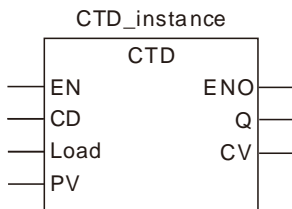

● **Parameters**

Parameter name	Meaning	Input/Output	Description	Valid range
CD	Down-counter input signal	Input	Control the counter to start counting down	TRUE or FALSE
Load	Load signal	Input	For writing the down-counter value	TRUE or FALSE
PV	Preset value	Input	Counter setting value	0 ~ 4294967295
Q	Output signal	Output	Q is TRUE when the counter counts down to 0.	TRUE or FALSE
CV	Counter value	Output	Counter present value	0 ~ 4294967295

	Boolean	Bit string					Integer						Real number		Time, date				String	
	BOOL	BYTE	WORD	DWORD	LWORD	USINT	UINT	UDINT	ULINT	SINT	INT	DINT	LINT	REAL	LREAL	TIME	DATE	TOD	DT	STRING
CU	●																			
Load	●																			
PV								●												
Q	●																			
CV								●												

Note:

The symbol ● indicates that the parameter is allowed to connect to the variable or constant of the data type.

● **Function Explanation**

- CTU functions as a down counter.
- When *Load* is reset to FALSE after being set to TRUE, the value of *PV* is written to *CV*. When *CD* changes from FALSE to TRUE, the counter makes the counter value decreased once and the value of *CV* is decreased by 1. When the value of *CV* reaches 0, *Q* is TRUE.

● **Precautions for Correct Use**

While *Load* is TRUE, the counter will not count down.



Programming Example

■ The variable table and program

Variable name	Data type	Initial value
CTD1	CTD	
CTD1_EN	BOOL	FALSE
CTD1_CD	BOOL	FALSE
CTD1_Load	BOOL	FALSE
CTD1_PV	UDINT	4
CTD1_Q	BOOL	
CTD1_CV	UDINT	

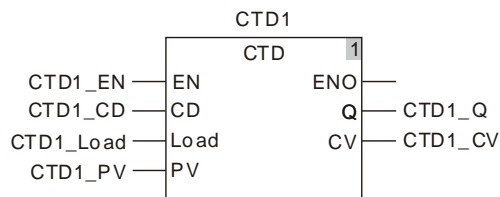

■ Timing Chart:

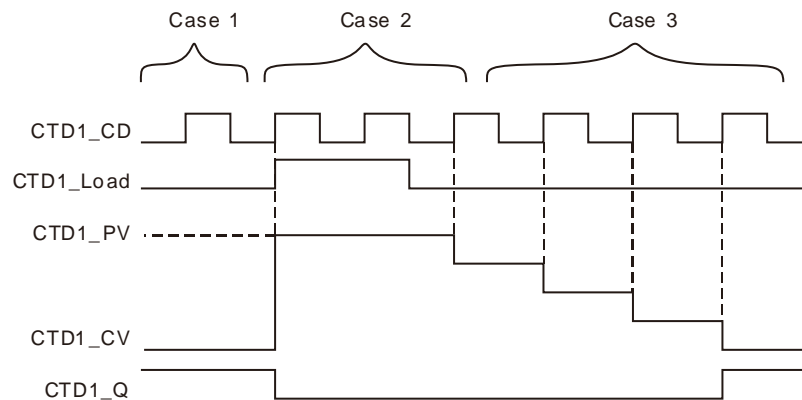

- Case 1 :** There is no impact on the output by triggering CTD1_CD when the value of CTD1_CV is 0.
- Case 2 :** When CTD1_Load is TRUE and CTD1_CV equals the set value of CTD1_PV, CTD1_Q changes from TRUE to FALSE. At the moment, CTD1_CV does not count down when CTD1_CD is triggered.
- Case 3 :** If CTD counts down normally and CTD1_Load is FALSE, the value of CTD1_CV is decreased by 1 whenever CTD1_CD is triggered once. CTD1_Q is TRUE when the value of CTD1_CV is decreased to 0.

8.8.3 CTUD

FB/FC	Explanation	Applicable model
FB	CTUD is used as an up-down counter.	DVP15MC11T DVP15MC11T-06

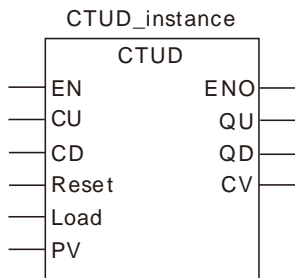

● Parameters

Parameter name	Meaning	Input/Output	Description	Valid range
CU	Up-counter input signal	Input	Control the counter to count up	TRUE or FALSE
CD	Down-counter input signal	Input	Control the counter to count down	TRUE or FALSE
Reset	Reset signal	Input	Reset counter present value	TRUE or FALSE
Load	Load signal	Input	For writing the down-counter value	TRUE or FALSE
PV	Preset value	Input	Counter setting value	0 ~ 4294967295
QU	Output signal	Output	Q is TRUE when CV equals PV.	TRUE or FALSE
QD	Output signal	Output	Q is TRUE when the counter counts down to 0.	TRUE or FALSE
CV	Counter value	Output	Counter present value	0 ~ 4294967295

	Boolean	Bit string					Integer						Real number		Time, date				String	
	BOOL	BYTE	WORD	DWORD	LWORD	USINT	UINT	UDINT	ULINT	SINT	INT	DINT	LINT	REAL	LREAL	TIME	DATE	TOD	DT	STRING
CU	●																			
CD	●																			
Reset	●																			
Load	●																			
PV								●												
QU	●																			
QD	●																			
CV								●												

Note:

The symbol ● indicates that the parameter is allowed to connect to the variable or constant of the data type.

- **Function Explanation**

CTUD is used as an up counter for counting up and a down counter for counting down.

- **Precautions for Correct Use**

- The counter will not count down while *Load* is TRUE.
- The counter will not count up while *Reset* is TRUE.



- **Programming Example**

- **The variable table and program**

Variable name	Data type	Initial value
CTUD1	CTUD	
CTUD1_EN	BOOL	FALSE
CTUD1_CU	BOOL	FALSE
CTUD1_CD	BOOL	FALSE
CTUD1_Reset	BOOL	FALSE
CTUD1_Load	BOOL	FALSE
CTUD1_PV	UDINT	4
CTUD1_QU	BOOL	
CTUD1_QD	BOOL	
CTUD1_CV	UDINT	

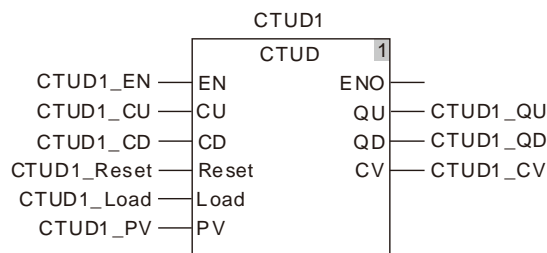

■ **Timing Chart:**

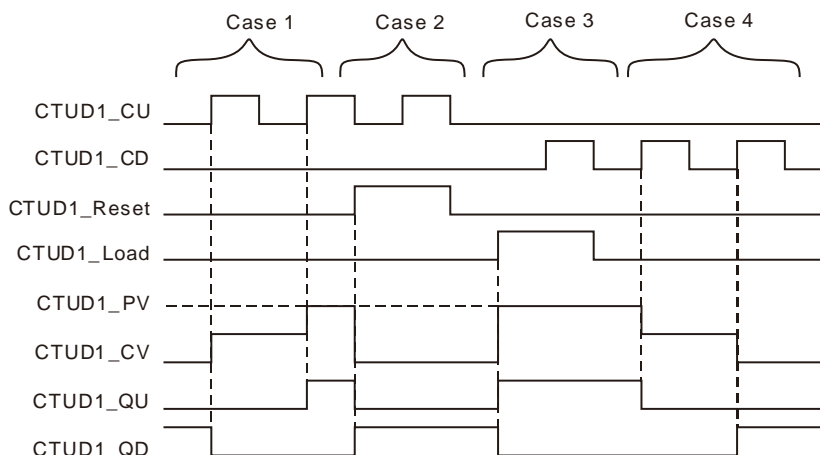

- Case 1 :** If CTUD counts up normally, the value of CTUD1_CV is increased by 1 whenever CTUD1_CU is triggered once.
- Case 2 :** When CTUD1_Reset is TRUE, CTUD1_CV is cleared to 0, CTUD1_QU changes to FALSE and CTUD1_QD changes to TRUE.
- Case 3 :** When CTUD1_Load is TRUE and CTUD1_CV equals CTUD1_PV, CTUD1_QU changes to TRUE and CTUD1_QD changes to FALSE. At the moment, if CTUD1_CD is triggered, the instruction can not count down.
- Case 4 :** If the instruction counts down normally, CTUD1_QU is FALSE when CTUD1_CD is TRUE. The value of CTUD1_CV is decreased by 1 whenever CTUD1_CD is triggered once. CTUD1_QD is TRUE when the value of CTUD1_CV is decreased to 0.

8.9 Math Instructions

8.9.1 ADD

FB/FC	Explanation	Applicable model
FC	ADD is used for the addition operation of two or more variables or constants.	DVP15MC11T DVP15MC11T-06

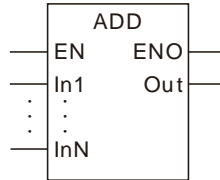

● Parameters

Parameter name	Meaning	Input/Output	Description	Valid range
In1	Augend	Input	Augend	Depends on the data type of the variable that the input parameter is connected to.
In2 to InN	Addend	Input	The maximum number of addends is 7, which means that N can be 2~8 and the number can be increased or reduced via the programming software in creating a program.	Depends on the data type of the variable that the input parameter is connected to.
Out	Sum	Output	The addition result of In1 to InN	Depends on the data type of the variable that the output parameter is connected to.

	Boolean	Bit string					Integer						Real number		Time, date			String		
	BOOL	BYTE	WORD	DWORD	LWORD	USINT	UINT	UDINT	ULINT	SINT	INT	DINT	LINT	REAL	LREAL	TIME	DATE	TOD	DT	STRING
In1 to InN		●	●	●	●	●	●	●	●	●	●	●	●	●	●			●	●	
In2 to InN		●	●	●	●	●	●	●	●	●	●	●	●	●	●	●				
Out		●	●	●	●	●	●	●	●	●	●	●	●	●	●	●		●	●	

Note:

The symbol ● indicates that the parameter is allowed to connect to the variable or constant of the data type.

● Function Explanation

- The instruction is used for the addition of two or more variables or constants. The result is output to *Out*, that is, $Out = In1 + In2 + \dots + InN$.
- The input parameters *In1~InN* in this instruction are allowed to be the variables of different types among bits, integers and real numbers. When *In1~InN* are the variables of different types, the addition operation will be performed based on the data type which can contain all valid ranges of *In1~InN* values. For example, the data type of *Out* is DINT if the data type of *In1* is INT and *In2* is DINT.

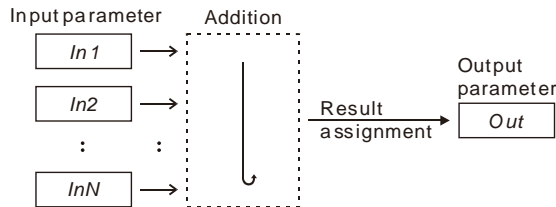

- The input and output variables are allowed to be of different data types among bits, integers and real numbers. When the data types of input and output variables are different, the data type of the output variable must include the valid ranges of data types of all input variables. Otherwise, there will be an error during the compiling of the software. For example, if the data types of *In1* and *In2* are INT and DINT respectively, the data type of *Out* is DINT. There will be an error during compiling of the software if the data type of the variable that *Out* is connected to is INT. No error will occur during the compiling of the software if the data type of the variable that *Out* is connected to is LINT.
- For the data type about time and date, following combinations are supported only.
 1. *In1* is TIME, *In2* is TIME and *Out* is TIME;
 2. *In1* is TOD (TIME_OF_DAY), *In2* is TIME and *Out* is TOD;
 3. *In1* is DT (DAY_AND_TIME), *In2* is TIME and *Out* is DT.

● **Precautions for Correct Use**

- The input variables are not allowed to omit. An error will occur during the compiling of the software if any input variable is omitted. But the output variable is allowed to omit.
- The sum of *In1~InN* may be out of the valid range of the data type of *Out*.
- The difference between *In1* and *In2* may be out of the valid range of the data type of *Out*.

For example, the data types of “ADD_In1” and “ADD_In2” are both INT with their respective values, 32767 and 1. If the data type of the output variable is INT, the output variable value will be -32768 as shown in the following table, variable 1. If the data type of the output variable is set to DINT, the output variable value will be 32768 as shown in the following table, variable 2.

➤ Variable 1

Variable name	Data type	Current value
ADD_EN	BOOL	TRUE
ADD_In1	INT	32767
ADD_In2	INT	1
Out1	INT	-32768

➤ Variable 2

Variable name	Data type	Current value
ADD_EN	BOOL	TRUE
ADD_In1	INT	32767
ADD_In2	INT	1
Out1	DINT	32768

➤ The program

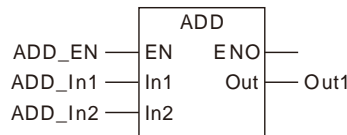

● **Programming Example1**

- The data types of variables *ADD_In1*, *ADD_In2* and *Out1* are all INT. The values of *ADD_In1* and *ADD_In2* are 10 and 50 respectively. The value of *Out1* is 60 when *ADD_EN* changes to TRUE as shown in Variable 1.
- The data types of variables *ADD_In1*, *ADD_In2* and *Out1* are all TIME. The values of *ADD_In1* and *ADD_In2* are TIME #1s and TIME #2s respectively. The value of *Out1* is TIME #3s when *ADD_EN* changes to TRUE as shown in Variable 2.
- The data types of variables *ADD_In1*, *ADD_In2* and *Out1* are DT, TIME and DT respectively. The values of *ADD_In1* and *ADD_In2* are DT#2016-9-1-8:00:00 and TIME#1H53M34S respectively. The value of *Out1* is DT#2016-09-01-09:53:34 when *ADD_EN* changes to TRUE as shown in Variable 3.

➤ **Variable 1**

Variable name	Data type	Current value
ADD_EN	BOOL	TRUE
ADD_In1	INT	10
ADD_In2	INT	50
Out1	INT	60

➤ **Variable 2**

Variable name	Data type	Current value
ADD_EN	BOOL	TRUE
ADD_In1	TIME	TIME #1s
ADD_In2	TIME	TIME #2s
Out1	TIME	TIME #3s

➤ **Variable 3**

Variable name	Data type	Current value
ADD_EN	BOOL	TRUE
ADD_In1	DT	DT#2016-9-1-8:00:00
ADD_In2	TIME	TIME#1H53M34S
Out1	DT	DT#2016-09-01-09:53:34

➤ **The program**

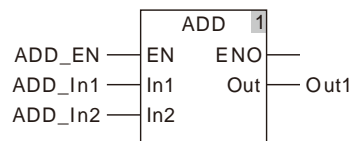

8.9.2 SUB

FB/FC	Explanation	Applicable model
FC	SUB is used for the subtraction operation of two variables or constants.	DVP15MC11T DVP15MC11T-06

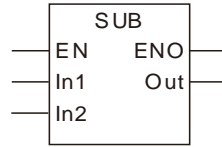

● Parameters

Parameter name	Meaning	Input/Output	Description	Valid range
In1	Minuend	Input	Minuend	Depends on the data type of the variable that the input parameter is connected to.
In2	Subtrahend	Input	Subtrahend	Depends on the data type of the variable that the input parameter is connected to.
Out	Difference	Output	The subtraction result of In1 and In2	Depends on the data type of the variable that the output parameter is connected to.

	Boolean	Bit string					Integer							Real number		Time, date				String
	BOOL	BYTE	WORD	DWORD	LWORD	USINT	UINT	UDINT	ULINT	SINT	INT	DINT	LINT	REAL	LREAL	TIME	DATE	TOD	DT	STRING
In1		●	●	●	●	●	●	●	●	●	●	●	●	●	●	●	●	●	●	
In2		●	●	●	●	●	●	●	●	●	●	●	●	●	●	●	●	●	●	
Out		●	●	●	●	●	●	●	●	●	●	●	●	●	●			●	●	

Note:

The symbol ● indicates that the parameter is allowed to connect to the variable or constant of the data type.

● Function Explanation

- The instruction is used for the subtraction of two or more variables or constants. The result is output to *Out*, that is, $Out = In1 - In2$.
- The input parameters *In1* and *In2* in this instruction are allowed to be the variables of different data types among bits, integers and real numbers. When *In1* and *In2* are the variables of different types, the subtraction operation will be performed based on the data type which can contain valid ranges of *In1* and *In2* values. For example, the data type of *Out* is DINT if the data type of *In1* is INT and *In2* is DINT.

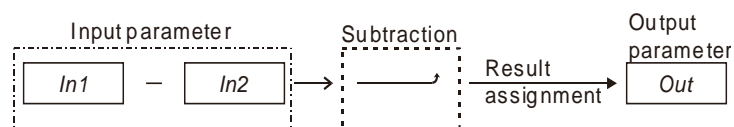

- The input and output variables are allowed to be of different data types among bits, integers and real numbers. When the data types of input and output variables are different, the data type of the output variable must include the valid ranges of data types of all input variables. Otherwise, there will be an error during the compiling of the software. For example, if the data types of *In1* and *In2* are INT and DINT respectively, the data type of *Out* is DINT. There will be an error during the compiling of the software if the data type of the variable that *Out* is connected to is INT. No error will occur during the compiling of the software if the data type of the variable that *Out* is connected to is LINT.
- For the data type of time and date, only following combinations are supported.
 1. In1 is TIME, In2 is TIME and Out is TIME;
 2. In1 is TOD, In2 is TIME and Out is TOD;
 3. In1 is TOD, In2 is TOD and Out is TIME;
 4. In1 is DATE, In2 is DATE and Out is TIME;
 5. In1 is DT, In2 is DT and Out is TIME;
 6. In1 is DT, In2 is TIME and Out is DT.

● Precautions for Correct Use

- The input variables are not allowed to omit. An error will occur during the compiling of the software if any input variable is omitted. But the output variable is allowed to omit.
- The difference between *In1* and *In2* may be out of the valid range of the data type of *Out*. For example, the data types of “SUB_In1” and “SUB_In2” are both INT with their respective values, -32768 and 1. If the data type of the output variable is INT, the output variable value will be 32767 as shown in the following table, variable 1. If the data type of the output variable is set to DINT, the output variable value will be -32769 as shown in the following table, variable 2.

➤ Variable 1

Variable name	Data type	Current value
SUB_EN	BOOL	TRUE
SUB_In1	INT	-32768
SUB_In2	INT	1
Out1	INT	32767

➤ Variable 2

Variable name	Data type	Current value
SUB_EN	BOOL	TRUE
SUB_In1	INT	-32768
SUB_In2	INT	1
Out1	DINT	-32769

➤ The Program

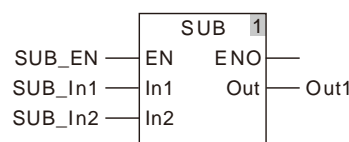

● Programming Example

- The data types of variables *SUB_In1*, *SUB_In2* and *Out1* are all INT and the values of *SUB_In1* and *SUB_In2* are 100 and 40 respectively. The value of *Out1* is 60 when *SUB_EN* changes to TRUE as shown in Variable 1.
- The data types of variables *SUB_In1*, *SUB_In2* and *Out1* are all TIME and the values of *SUB_In1* and *SUB_In2* are TIME#4s and TIME#1s respectively. The value of *Out1* is TIME#3s when *SUB_EN* changes to TRUE as shown in Variable 2.

- The data types of variables *SUB_In1*, *SUB_In2* and *Out1* are DATE, DATE and TIME and the values of *SUB_In1* and *SUB_In2* are DATE#2016-10-1 and DATE#2016-9-1 respectively. The value of *Out1* is TIME#30D when *SUB_EN* changes to TRUE as shown in Variable 3.

➤ **Variable 1**

Variable name	Data type	Current value
SUB_EN	BOOL	TRUE
SUB_In1	INT	100
SUB_In2	INT	40
Out1	INT	60

➤ **Variable 2**

Variable name	Data type	Current value
SUB_EN	BOOL	TRUE
SUB_In1	TIME	TIME#4s
SUB_In2	TIME	TIME#1s
Out1	TIME	TIME#3s

➤ **Variable 3**

Variable name	Data type	Current value
SUB_EN	BOOL	TRUE
SUB_In1	DATE	DATE#2016-10-1
SUB_In2	DATE	DATE#2016-9-1
Out1	TIME	TIME#30D

➤ **The program**

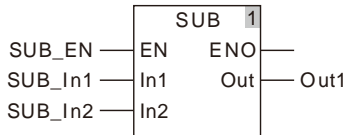

8.9.3 MUL

FB/FC	Explanation	Applicable model
FC	MUL is used for the multiplication of two or more variables or constants.	DVP15MC11T DVP15MC11T-06

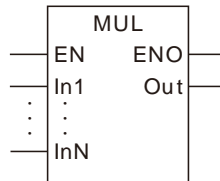

● Parameters

Parameter name	Meaning	Input/Output	Description	Valid range
In1	Multiplicand	Input	Multiplicand	Depends on the data type of the variable that the input parameter is connected to.
In2 to InN	Multiplier	Input	The maximum number of multipliers is 7, which means that N can be 2~8 and the number can be increased or reduced via the programming software in creating a program.	Depends on the data type of the variable that the input parameter is connected to.
Out	Product	Output	The multiplication result of In1 ~ InN	Depends on the data type of the variable that the output parameter is connected to.

	Boolean	Bit string				Integer							Real number		Time, date				String	
	BOOL	BYTE	WORD	DWORD	LWORD	USINT	UINT	UDINT	ULINT	SINT	INT	DINT	LINT	REAL	LREAL	TIME	DATE	TOD	DT	STRING
In1 to InN		●	●	●	●	●	●	●	●	●	●	●	●	●						
Out		●	●	●	●	●	●	●	●	●	●	●	●	●						

Note:

The symbol ● indicates that the parameter is allowed to connect to the variable or constant of the data type.

● Function Explanation

- The instruction is used for the multiplication of two or more variables or constants. The result is output to *Out*, that is, $Out = In1 * In2 * \dots * InN$.

- The input parameters $In1 \sim InN$ are allowed to be the variables of different data types in this instruction. When $In1 \sim InN$ are the variables of different data types, the multiplication will be performed based on the data type which can contain valid ranges of $In1 \sim InN$ values. For example, the data type of Out is DINT if the data type of $In1$ is INT and $In2$ is DINT.

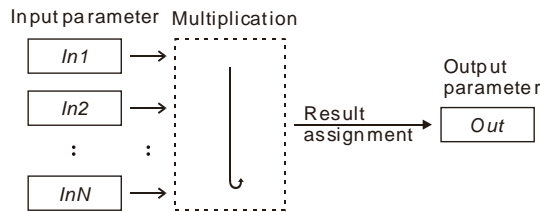

- The input and output variables are allowed to be of different data types in this instruction. When the data types of input and output variables are different, the range of the data type of the output variable must include the valid ranges of data types of all input variables. Otherwise, there will be an error during the compiling of the software. For example, if the data types of $In1$ and $In2$ are INT and DINT respectively, the data type of Out is DINT. There will be an error during the compiling of the software if the data type of the variable that Out is connected to is INT. No error will occur during the compiling of the software if the data type of the variable that Out is connected to is LINT.

● **Precautions for Correct Use**

- The input variables are not allowed to omit. An error will occur during the compiling of the software if any input variable is omitted. But the output variable is allowed to omit.
- The multiplication result of $In1 \sim In2$ may be out of the valid range of the data type of Out . For example, the data types of “ MUL_In1 ” and “ MUL_In2 ” are both INT with their respective values, 20000 and 2. If the data type of the output variable is INT, the output variable value will be -25536 as shown in the following table, Variable 1. If the data type of the output variable is set to DINT, the output variable value will be 40000 as shown in the following table, Variable 2.

➤ **Variable 1**

Variable name	Data type	Current value
MUL_EN	BOOL	TRUE
MUL_In1	INT	20000
MUL_In2	INT	2
Out1	INT	-25536

➤ **Variable 2**

Variable name	Data type	Current value
MUL_EN	BOOL	TRUE
MUL_In1	INT	20000
MUL_In2	INT	2
Out1	DINT	40000

➤ **The Program**

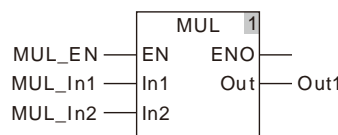

● **Programming Example**

- The data types of variables MUL_In1 , MUL_In2 and $Out1$ are all INT. The values of MUL_In1 and MUL_In2 are 10 and 50 respectively. The value of $Out1$ is 500 when MUL_EN changes to TRUE.

The variable table and program

Variable name	Data type	Initial value
MUL_EN	BOOL	TRUE
MUL_In1	INT	10
MUL_In2	INT	50
Out1	INT	500

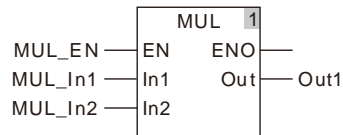

8.9.4 DIV

FB/FC	Explanation	Applicable model
FC	DIV is used for the division operation of two variables or constants.	DVP15MC11T DVP15MC11T-06

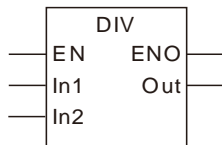

● Parameters

Parameter name	Meaning	Input/Output	Description	Valid range
In1	Dividend	Input	Dividend	Depends on the data type of the variable that the input parameter is connected to.
In2	Divisor	Input	Divisor	Depends on the data type of the variable that the input parameter is connected to. 0 is excluded.
Out	Quotient	Output	The division result of In1 and In2	Depends on the data type of the variable that the output parameter is connected to.

	Boolean	Bit string					Integer							Real number		Time, date				String
	BOOL	BYTE	WORD	DWORD	LWORD	USINT	UINT	UDINT	ULINT	SINT	INT	DINT	LINT	REAL	LREAL	TIME	DATE	TOD	DT	STRING
In1		●	●	●	●	●	●	●	●	●	●	●	●	●						
In2		●	●	●	●	●	●	●	●	●	●	●	●	●						
Out		●	●	●	●	●	●	●	●	●	●	●	●	●						

Note:

The symbol ● indicates that the parameter is allowed to connect to the variable or constant of the data type.

● Function Explanation

- The instruction is used for the division of two variables or constants. The result is output to *Out*, that is, $Out = In1 / In2$.
- The input parameters *In1* and *In2* are allowed to be the variables of different data types in this instruction. When *In1* and *In2* are the variables of different data types, the division will be performed based on the data type which can contain valid ranges of *In1* and *In2*. For example, the data type of *Out* is DINT if the data type of *In1* is INT and *In2* is DINT.

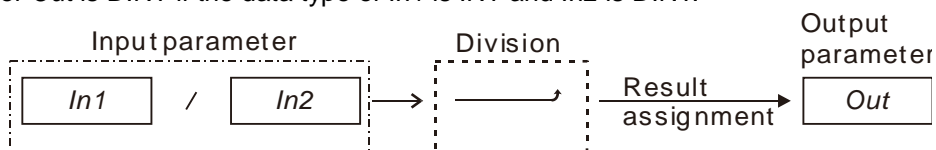

- The input and output variables are allowed to be of different data types in this instruction. When the data types of input and output variables are different, the range of the data type of the output variable must include the valid ranges of data types of all input variables. Otherwise, there will be an error during the compiling of the software. For example, if the data types of *In1* and *In2* are INT and DINT respectively, the data type of *Out* is DINT. There will be an error during the compiling of the software if the data type of *Out* is INT. No error will occur during the compiling of the software if the data type of *Out* is LINT.

● Precautions for Correct Use

- The input variables are not allowed to omit. An error will occur during the compiling of the software if any input variable is omitted. But the output variable is allowed to omit.
- The input value of *In2* can not be 0. In other words, the divisor in the division operation can not be 0. The value of *Out* will be 0 if the value of *In2* is 0.
- The division result of *In1* and *In2* may be out of the valid range of the data type of *Out*. For example, the data types of "DIV_In1" and "DIV_In2" are both INT with their respective values, -32768 and -1. If the data type of the output variable is INT, the output variable value will be -32768 as shown in the following table, variable 1. If the data type of the output variable is set to DINT, the output variable value will be 32768 as shown in the following table, variable 2.

➤ Variable 1

Variable name	Data type	Current value
DIV_EN	BOOL	TRUE
DIV_In1	INT	-32768
DIV_In2	INT	-1
Out1	INT	-32768

➤ Variable 2

Variable name	Data type	Current value
DIV_EN	BOOL	TRUE
DIV_In1	INT	-32768
DIV_In2	INT	-1
Out1	DINT	32768

➤ The Program

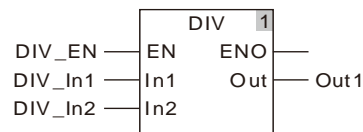

- The result is always an integer for the division of two integers. Even if there is a remainder for the division of two integers, the remainder is cut. For example, the data types of *In1* and *In2* are both INT with their respective values, 10 and 3. And the data type of *Out* is INT and Real and thus its value is 3 and 3.0 respectively as illustrated in the following figure.

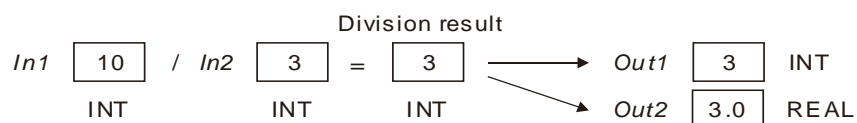

The data type of *Out* is a real number for the division of an integer and a real number or the division of two real numbers. The value of *Out* is shown as below including its fractional part when there is a remainder for this type of division.

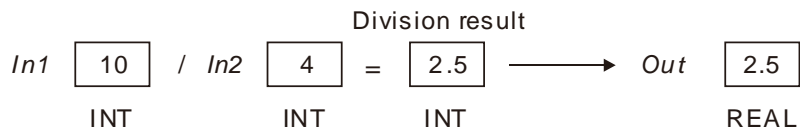

● **Programming Example**

- The data types of variables *DIV_In1*, *DIV_In2* and *Out1* are all INT. The values of *DIV_In1* and *DIV_In2* are 100 and 20 respectively. The value of *Out1* is 5 when *DIV_EN* changes to TRUE.

The variable table and program

Variable name	Data type	Initial value
DIV_EN	BOOL	TRUE
DIV_In1	INT	100
DIV_In2	INT	20
Out1	INT	5

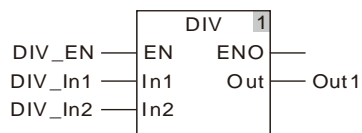

8.9.5 MOD

FB/FC	Explanation	Applicable model
FC	MOD finds the remainder for division of two integer variables or constants.	DVP15MC11T DVP15MC11T-06

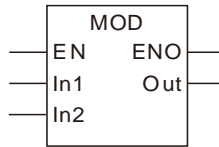

Parameters

Parameter name	Meaning	Input/Output	Description	Valid range
In1	Dividend	Input	Dividend	Depends on the data type of the variable that the input parameter is connected to.
In2	Divisor	Input	Divisor	Depends on the data type of the variable that the input parameter is connected to. 0 is excluded.
Out	Remainder	Output	The remainder got by dividing In1 by In2	Depends on the data type of the variable that the output parameter is connected to.

	Boolean	Bit string					Integer						Real number		Time, date			String		
	BOOL	BYTE	WORD	DWORD	LWORD	USINT	UINT	UDINT	ULINT	SINT	INT	DINT	LINT	REAL	LREAL	TIME	DATE	TOD	DT	STRING
In1		●	●	●	●	●	●	●	●	●	●	●								
In2		●	●	●	●	●	●	●	●	●	●	●								
Out		●	●	●	●	●	●	●	●	●	●	●								

Note:

The symbol ● indicates that the parameter is allowed to connect to the variable or constant of the data type.

Function Explanation

- The instruction is used to get the remainder of the division of two integer variables or constants. The result is output to *Out*, that is, $Out = In1 - (In1 / In2) * In2$.
- The input variable and input variable or the input variable and output variable are allowed to be of different data types in this instruction. When the data types of input and output variables are different, the data type of the output variable must include the valid ranges of data types of all input variables. Otherwise, there will be an error during the compiling of the software. For example, if the data types of *In1* and *In2* are INT and DINT respectively, the data type of *Out* is DINT. There will be an error during the compiling of the software if the data type of *Out* is INT. No error will occur during the compiling of the software if the data type of *Out* is LINT.

● **Precautions for Correct Use**

- The input variables are not allowed to omit. An error will occur during the compiling of the software if any input variable is omitted. But the output variable is allowed to omit.
- The input value of *In2* can not be 0. In other words, the divisor in the division operation can not be 0. The value of *Out* will be 0 if the value of *In2* is 0.

● **Programming Example**

- The data types of variables *MOD_In1*, *MOD_In2* and *Out1* are all INT. The values of *MOD_In1* and *MOD_In2* are 10 and 4 respectively. The value of *Out1* is 2 when *MOD_EN* changes to TRUE.

The Variable and program

Variable name	Data type	Current value
MOD_EN	BOOL	TRUE
MOD_In1	INT	10
MOD_In2	INT	4
Out1	INT	2

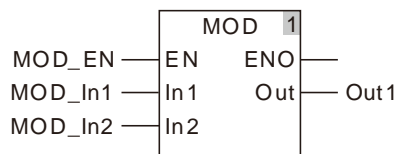

8.9.6 MODREAL

FB/FC	Explanation	Applicable model
FC	MODREAL finds the remainder for division of two floating- point variables or constants.	DVP15MC11T DVP15MC11T-06

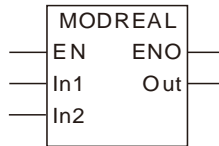

Parameters

Parameter name	Meaning	Input/Output	Description	Valid range
In1	Dividend	Input	Dividend	Depends on the data type of the variable that the input parameter is connected to.
In2	Divisor	Input	Divisor	Depends on the data type of the variable that the input parameter is connected to. 0 is excluded.
Out	Remainder	Output	The remainder got by dividing In1 by In2	Depends on the data type of the variable that the output parameter is connected to.

	Boolean	Bit string					Integer						Real number		Time, date				String	
	BOOL	BYTE	WORD	DWORD	LWORD	USINT	UINT	UDINT	ULINT	SINT	INT	DINT	LINT	REAL	LREAL	TIME	DATE	TOD	DT	STRING
In1														●	●					
In2														●	●					
Out														●	●					

Note:

The symbol ● indicates that the parameter is allowed to connect to the variable or constant of the data type.

Function Explanation

- The instruction is used to find the remainder of the division of two floating- point variables or constants and the result is output to *Out*.
- The input variable and input variable or the input variable and output variable are allowed to be of different data types in this instruction.

Precautions for Correct Use

- The input variables are not allowed to omit. An error will occur during the compiling of the software if any input variable is omitted. But the output variable is allowed to omit.
- The input value of *In2* can not be 0. In other words, the divisor in the division operation can not be 0. The value of *Out* will be 0 if the value of *In2* is 0.

● **Programming Example**

- The data types of variables *MODREAL_In1*, *MODREAL_In2* and *Out1* are REAL, REAL and LREAL respectively. The values of *MODREAL_In1* and *MOD_In2* are 10.5 and 2.5 respectively. The value of *Out1* is 0.5 when *MODREAL_EN* changes to TRUE.

The variable table and program

Variable name	Data type	Current value
MODREAL_EN	BOOL	TRUE
MODREAL_In1	REAL	10.5
MODREAL_In2	REAL	2.5
Out1	LREAL	0.5

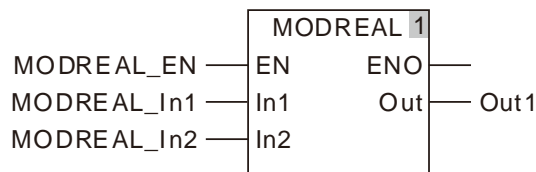

8.9.7 MODTURNS

FB/FC	Explanation	Applicable model
FC	MODTURN finds the signed integral part for modulo division of two floating-point variables or constants.	DVP15MC11T DVP15MC11T-06

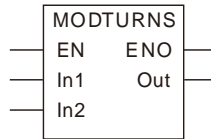

Parameters

Parameter name	Meaning	Input/Output	Description	Valid range
In1	Input value	Input	Input value	Depends on the data type of the variable that the input parameter is connected to.
In2	Modulo range	Input	Modulo range	Depends on the data type of the variable that the input parameter is connected to. 0 is excluded.
Out	Number of modulo rotations	Output	Number of modulo rotations	Depends on the data type of the variable that the output parameter is connected to.

	Boolean	Bit string					Integer						Real number		Time, date			String		
	BOOL	BYTE	WORD	DWORD	LWORD	USINT	UINT	UDINT	ULINT	SINT	INT	DINT	LINT	REAL	LREAL	TIME	DATE	TOD	DT	STRING
In1														●	●					
In2														●	●					
Out											●									

Note:

The symbol ● indicates that the parameter is allowed to connect to the variable or constant of the data type.

Function Explanation

- MODTURN is used to carry out modulo division of two floating-point variables or constants and get the signed integral component. The result is output to *Out*. The number of modulo rotations of an axis can be calculated according to its set absolute position.
- The input variable and input variable or the input variable and output variable are allowed to be of different data types in this instruction.

● **Precautions for Correct Use**

- The input variables are not allowed to omit. An error will occur during the compiling of the software if any input variable is omitted. But the output variable is allowed to omit.
- The input value of *In2* can not be 0. In other words, the divisor in the division operation can not be 0. The value of *Out* will be 0 if the value of *In2* is 0.

● **Programming Example**

- The data types of variables *MODTURNS_In1*, *MODTURNS_In2* are both REAL and *Out1* is DINT. The values of *MODTURNS_In1* and *MODTURNS_In2* are 800.23 and 360.0 respectively. The value of *Out1* is 2 when *MODTURNS_EN* changes to TRUE.

The variable table and program

Variable name	Data type	Current value
MODTURNS_EN	BOOL	TRUE
MODTURNS_In1	REAL	800.23
MODTURNS_In2	REAL	360.0
Out1	DINT	2

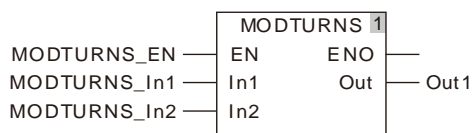

8.9.8 MODABS

FB/FC	Explanation	Applicable model
FC	MODABS finds the unsigned modulo value for modulo division of two floating-point variables or constants.	DVP15MC11T DVP15MC11T-06

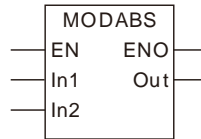

● Parameters

Parameter name	Meaning	Input/ Output	Description	Valid range
In1	Input value	Input	Input value	Depends on the data type of the variable that the input parameter is connected to.
In2	Modulo range	Input	Modulo range	Depends on the data type of the variable that the input parameter is connected to. 0 is excluded.
Out	Modulo value	Output	Modulo value	Depends on the data type of the variable that the output parameter is connected to.

	Boolean	Bit string					Integer						Real number		Time, date			String		
	BOOL	BYTE	WORD	DWORD	LWORD	USINT	UINT	UDINT	ULINT	SINT	INT	DINT	LINT	REAL	LREAL	TIME	DATE	TOD	DT	STRING
In1														●	●					
In2														●	●					
Out															●					

Note:

The symbol ● indicates that the parameter is allowed to connect to the variable or constant of the data type.

● Function Explanation

- MODABS is used to perform modulo division of two floating-point variables or constants and get the unsigned modulo value. The result is output to *Out*. The modulo position can be calculated according to the absolute position of the axis.
- The input variable and input variable or the input variable and output variable are allowed to be of different data types in this instruction.

● **Precautions for Correct Use**

- The input variables are not allowed to omit. An error will occur during the compiling of the software if any input variable is omitted. But the output variable is allowed to omit.
- The input value of *In2* can not be 0. In other words, the divisor in the division operation can not be 0. The value of *Out* will be 0 if the value of *In2* is 0.

● **Programming Example**

- The data types of variables *MODABS_In1* and *MODABS_In2* are both REAL and the data type of *Out1* is LREAL. The values of *MODABS_In1* and *MODABS_In2* are 400.23 and 360.0 respectively. The value of *Out1* is 40.2300109863281 when *MODABS_EN* changes to TRUE. The values of *MODABS_In1* and *MODABS_In2* are -400.23 and 360.0 respectively. The value of *Out1* is 319.769989013672 when *MODABS_EN* changes to TRUE.

➤ **Variable 1**

Variable name	Data type	Current value
MODABS_EN	BOOL	TRUE
MODABS_In1	REAL	400.23
MODABS_In2	REAL	360.0
Out1	LREAL	40.2300109863281

➤ **Variable 2**

Variable name	Data type	Current value
MODABS_EN	BOOL	TRUE
MODABS_In1	REAL	-400.23
MODABS_In2	REAL	360.0
Out1	LREAL	319.769989013672

➤ **The program**

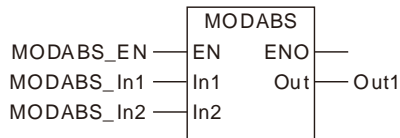

8.9.9 ABS

FB/FC	Explanation	Applicable model
FC	ABS finds the absolute value of an integer or a real number.	DVP15MC11T DVP15MC11T-06

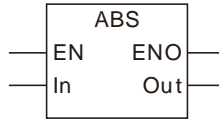

Parameters

Parameter name	Meaning	Input/Output	Description	Valid range
In	Number to process	Input	Number to process	Depends on the data type of the variable that the input parameter is connected to.
Out	Absolute value	Output	Absolute value of <i>In</i>	Depends on the data type of the variable that the output parameter is connected to.

	Boolean	Bit string					Integer							Real number		Time, date				String
	BOOL	BYTE	WORD	DWORD	LWORD	USINT	UINT	UDINT	ULINT	SINT	INT	DINT	LINT	REAL	LREAL	TIME	DATE	TOD	DT	STRING
In		●	●	●	●	●	●	●	●	●	●	●	●	●						
Out		●	●	●	●	●	●	●	●	●	●	●	●	●						

Note:

The symbol ● indicates that the parameter is allowed to connect to the variable or constant of the data type.

Function Explanation

- ABS finds the absolute value of the input parameter *In*.
The result is output to *Out*. That is, $Out = |In|$.
- The input variable and output variable are allowed to be of different data types in this instruction. When the data types of input and output variables are different, the range of the data type of the output variable must include the valid ranges of data types of all input variables. Otherwise, there will be an error during the compiling of the software.

Precautions for Correct Use

- The input variable is not allowed to omit. An error will occur during the compiling of the software if the input variable is omitted. But the output variable is allowed to omit.

Programming Example

- The data types of variables *ABS_In* and *Out1* are both INT and the value of *ABS_In* is -10. The value of *Out1* is 10 when *ABS_EN* changes to TRUE. The value of *Out1* is 20 as *ABS_In* is 20.

➤ **Variable 1**

Variable name	Data type	Current value
ABS_EN	BOOL	TRUE
ABS_In	INT	-10
Out1	INT	10

➤ **Variable 2**

Variable name	Data type	Current value
ABS_EN	BOOL	TRUE
ABS_In	INT	20
Out1	INT	20

➤ **The program**

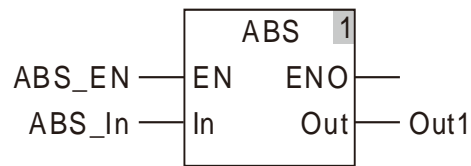

8.9.10 DegToRad

FB/FC	Explanation	Applicable model
FC	DegToRad is used to convert degrees to radians.	DVP15MC11T DVP15MC11T-06

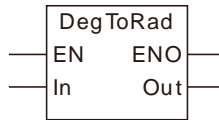

● Parameters

Parameter name	Meaning	Input/Output	Description	Valid range
In	Degrees	Input	Degrees to convert	Depends on the data type of the variable that the input parameter is connected to.
Out	Radians	Output	Radians converted from degrees	Depends on the data type of the variable that the output parameter is connected to.

	Boolean	Bit string					Integer						Real number		Time, date			String		
	BOOL	BYTE	WORD	DWORD	LWORD	USINT	UINT	UDINT	ULINT	SINT	INT	DINT	LINT	REAL	LREAL	TIME	DATE	TOD	DT	STRING
In		●	●	●	●	●	●	●	●	●	●	●	●	●						
Out														●						

Note:

The symbol ● indicates that the parameter is allowed to connect to the variable or constant of the data type.

● Function Explanation

- DegToRad is used to convert the input parameter *In* to a radian and the result is output to *Out*. That is, $Out = (In/180) * \pi$.
- The units of *In* and *Out* are degree (°) and radian respectively.
- Users can choose different data types for the input parameter in this instruction. But the data type of the output parameter is restricted to LREAL. An error will occur during the compiling of the software if the data type of the output parameter is not LREAL.

● Precautions for Correct Use

- The input variables are not allowed to omit. An error will occur during the compiling of the software if the input variable is omitted. But the output variables are allowed to omit.

● Programming Example

- The data types of *DegToRad_In* and *Out1* are INT and LREAL respectively. The value of *Out1* is 0.174532925199433 if the value of *DegToRad_In* is 10 when *DegToRad_EN* changes to TRUE. The value of *Out1* is -0.174532925199433 as *DegToRad_In* is -10.

➤ **Variable 1**

Variable name	Data type	Current value
DegToRad_EN	BOOL	TRUE
DegToRad_In	INT	10
Out1	LREAL	0.174532925199433

➤ **Variable 2**

Variable name	Data type	Current value
DegToRad_EN	BOOL	TRUE
DegToRad_In	INT	-10
Out1	LREAL	-0.174532925199433

➤ **The program**

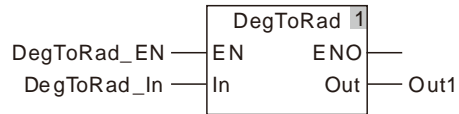

8.9.11 RadToDeg

FB/FC	Explanation	Applicable model
FC	DegToRad is used to convert radians to degrees.	DVP15MC11T DVP15MC11T-06

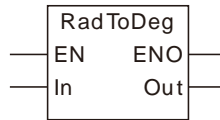

● Parameters

Parameter name	Meaning	Input/Output	Description	Valid range
In	Radians	Input	Radians to convert	Depends on the data type of the variable that the input parameter is connected to.
Out	Degrees	Output	Degrees converted from radians	Depends on the data type of the variable that the output parameter is connected to.

	Boolean	Bit string					Integer							Real number		Time, date			String	
	BOOL	BYTE	WORD	DWORD	LWORD	USINT	UINT	UDINT	ULINT	SINT	INT	DINT	LINT	REAL	LREAL	TIME	DATE	TOD	DT	STRING
In		●	●	●	●	●	●	●	●	●	●	●	●	●						
Out														●						

Note:

The symbol ● indicates that the parameter is allowed to connect to the variable or constant of the data type.

● Function Explanation

- RadToDeg is used to convert the input parameter *In* to degrees and the result is output to *Out*. That is, $Out = (In/\pi) * 180$.
- The units of *In* and *Out* are radian and degree (°) respectively.
- Users can choose different data types for the input parameter in this instruction. But the data type of the output parameter is restricted to LREAL. An error will occur during the compiling of the software if the data type of the output parameter is not LREAL.

● Precautions for Correct Use

- The input variable is not allowed to omit. An error will occur during the compiling of the software if the input variable is omitted. But the output variable is allowed to omit.

● **Programming Example**

- The data types of variables *RadToDeg_In* and *Out1* are INT and LREAL respectively. The value of *Out1* is 572. 957795130824 if the value of *RadToDeg_In* is 10 when *RadToDeg_EN* changes to TRUE. The value of *Out1* is -572. 957795130824 as *RadToDeg_In* is -10.

➤ **Variable 1**

Variable name	Data type	Current value
RadToDeg_EN	BOOL	TRUE
RadToDeg_In	INT	10
Out1	LREAL	572. 957795130824

➤ **Variable 2**

Variable name	Data type	Current value
RadToDeg_EN	BOOL	TRUE
RadToDeg_In	INT	-10
Out1	LREAL	-572. 957795130824

➤ **The program**

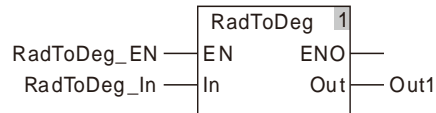

8.9.12 SIN

FB/FC	Explanation	Applicable model
FC	SIN is used to find the sine of a number and the result is output to <i>Out</i> . The unit of <i>In</i> is radian.	DVP15MC11T DVP15MC11T-06

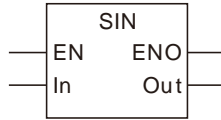

Parameters

Parameter name	Meaning	Input/Output	Description	Valid range
In	Radians to process	Input	Radians to process	Depends on the data type of the variable that the input parameter is connected to.
Out	Operation result	Output	Operation result	-1.0000000000000000 ~ 1.0000000000000000

	Boolean	Bit string					Integer						Real number		Time, date				String	
	BxOOL	BYTE	WORD	DWORD	LWORD	USINT	UINT	UDINT	ULINT	SINT	INT	DINT	LINT	REAL	LREAL	TIME	DATE	TOD	DT	STRING
In		●	●	●	●	●	●	●	●	●	●	●	●	●						
Out														●						

Note:

The symbol ● indicates that the parameter is allowed to connect to the variable or constant of the data type.

Function Explanation

- SIN is used to calculate the sine of the input parameter *In* and the result is output to *Out*.

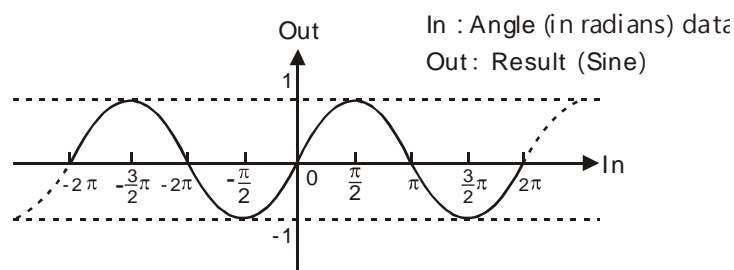

- Users can choose different data types for the input parameter in this instruction. But the data type of the output parameter is restricted to LREAL. An error will occur during the compiling of the software if the data type of the output parameter is not LREAL.

● **Precautions for Correct Use**

- The input variable setting is not allowed to omit. An error will occur during the compiling of the software if any input variable setting is omitted. But the output variable setting is allowed to omit.

● **Programming Example**

- The data types of variables *SIN_In* and *Out1* are INT and LREAL respectively. The value of *Out1* is -0.54402111088937 if the value of *SIN_In* is 10 when *SIN_EN* changes to TRUE. The value of *Out1* is 0.54402111088937 as *SIN_In* is -10.

➤ Variable 1

Variable name	Data type	Current value
SIN_EN	BOOL	TRUE
SIN_In	INT	10
Out1	LREAL	-0.54402111088937

➤ Variable 2

Variable name	Data type	Current value
SIN_EN	BOOL	TRUE
SIN_In	INT	-10
Out1	LREAL	0.54402111088937

➤ The program

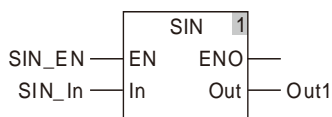

8.9.13 COS

FB/FC	Explanation	Applicable model
FC	COS is used to get the cosine of a number and the result is output to <i>Out</i> . The unit of <i>In</i> is radian.	DVP15MC11T DVP15MC11T-06

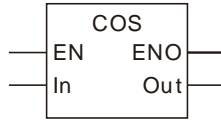

Parameters

Parameter name	Meaning	Input/Output	Description	Valid range
In	Radians to process	Input	Radians to process	Depends on the data type of the variable that the input parameter is connected to.
Out	Operation result	Output	Operation result	-1.0000000000000000~ 1.0000000000000000

	Boolean	Bit string					Integer							Real number		Time, date				String	
		BOOL	BYTE	WORD	DWORD	LWORD	USINT	UINT	UDINT	ULINT	SINT	INT	DINT	LINT	REAL	LREAL	TIME	DATE	TOD	DT	STRING
In		●	●	●	●	●	●	●	●	●	●	●	●	●	●						
Out															●						

Note:

The symbol ● indicates that the parameter is allowed to connect to the variable or constant of the data type.

Function Explanation

- COS is used to calculate the cosine of the input parameter *In* and the result is output to *Out*.

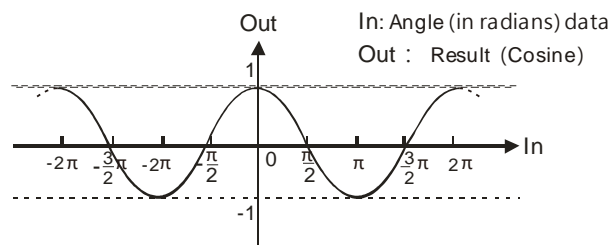

- Users can choose different data types for the input parameter in this instruction. But the data type of the output parameter is restricted to LREAL. An error will occur during the compiling of the software if the data type of the output parameter is not LREAL.

● **Precautions for Correct Use**

- The input variable is not allowed to omit. An error will occur during the compiling of the software if the input variable is omitted. But the output variable is allowed to omit.

● **Programming Example**

- The data types of variables *COS_In* and *Out1* are INT and LREAL respectively. The value of *Out1* is -0.839071529076452 if the value of *COS_In* is 10 when *COS_EN* changes to TRUE. The value of *Out1* is -0.839071529076452 as *COS_In* is -10.

➤ Variable 1

Variable name	Data type	Current value
COS_EN	BOOL	TRUE
COS_In	INT	10
Out1	LREAL	-0.839071529076452

➤ Variable 2

Variable name	Data type	Current value
COS_EN	BOOL	TRUE
COS_In	INT	-10
Out1	LREAL	-0.839071529076452

➤ The program

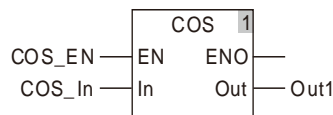

8.9.14 TAN

FB/FC	Explanation	Applicable model
FC	TAN is used to get the tangent of a number and the result is output to <i>Out</i> . The unit of <i>In</i> is radian.	DVP15MC11T DVP15MC11T-06

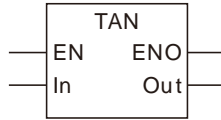

● Parameters

Parameter name	Meaning	Input/Output	Description	Valid range
In	Radians to process	Input	Radians to process	Depends on the data type of the variable that the input parameter is connected to.
Out	Operation result	Output	Operation result	Depends on the data type of the variable that the output parameter is connected to.

	Boolean	Bit string					Integer						Real number		Time, date			String		
	BOOL	BYTE	WORD	DWORD	LWORD	USINT	UINT	UDINT	ULINT	SINT	INT	DINT	LINT	REAL	LREAL	TIME	DATE	TOD	DT	STRING
In		●	●	●	●	●	●	●	●	●	●	●	●	●						
Out														●						

Note:

The symbol ● indicates that the parameter is allowed to connect to the variable or constant of the data type.

● Function Explanation

- TAN is used to calculate the tangent of the input parameter *In* and the result is output to *Out*.

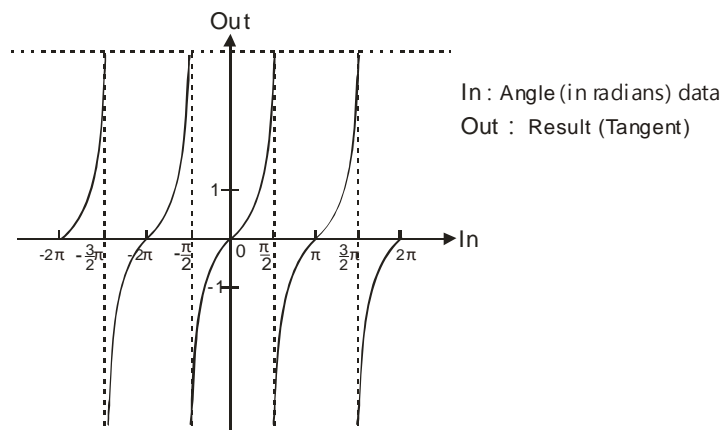

- Users can choose different data types for the input parameter in this instruction. But the data type of the output parameter is restricted to LREAL. An error will occur during the compiling of the software if the data type of the output parameter is not LREAL.

● **Precautions for Correct Use**

- The input variable is not allowed to omit. An error will occur during the compiling of the software if the input variable is omitted. But the output variable is allowed to omit.

● **Programming Example**

- The data types of variables *TAN_In* and *Out1* are INT and LREAL respectively. The value of *Out1* is 0.648360827459087 if the value of *TAN_In* is 10 when *TAN_EN* changes to TRUE. The value of *Out1* is -0.648360827459087 as *TAN_In* is -10.

➤ Variable 1

Variable name	Data type	Current value
TAN_EN	BOOL	TRUE
TAN_In	INT	10
Out1	LREAL	0.648360827459087

➤ Variable 2

Variable name	Data type	Current value
TAN_EN	BOOL	TRUE
TAN_In	INT	-10
Out1	LREAL	-0.648360827459087

➤ The program

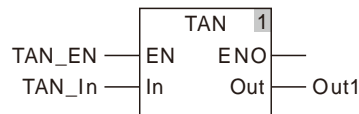

8.9.15 ASIN

FB/FC	Explanation	Applicable model
FC	ASIN is used to get the arc sine of a number and the result is output to <i>Out</i> . The unit of <i>Out</i> is radian.	DVP15MC11T DVP15MC11T-06

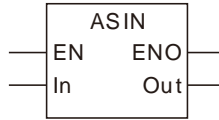

● Parameters

Parameter name	Meaning	Input/Output	Description	Valid range
In	Number to process	Input	Number to process	Depends on the data type of the variable that the input parameter is connected to.
Out	Operation result	Output	Operation result	$-\pi/2 \sim \pi/2$

	Boolean	Bit string					Integer						Real number		Time, date				String	
	BOOL	BYTE	WORD	DWORD	LWORD	USINT	UINT	UDINT	ULINT	SINT	INT	DINT	LINT	REAL	LREAL	TIME	DATE	TOD	DT	STRING
In		●	●	●	●	●	●	●	●	●	●	●	●	●	●					
Out														●						

Note:

The symbol ● indicates that the parameter is allowed to connect to the variable or constant of the data type.

● Function Explanation

- ASIN is used to calculate the arc sine of the input parameter *In* and the result is output to *Out*.

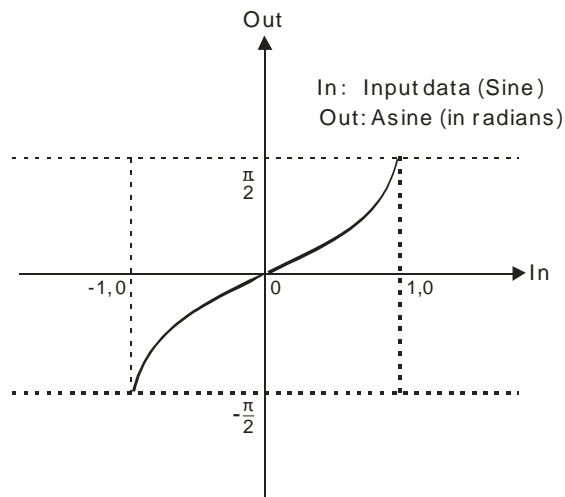

- Users can choose different data types for the input parameter in this instruction. But the data type of the output parameter is restricted to LREAL. An error will occur during the compiling of the software if the data type of the output parameter is not LREAL.

● Precautions for Correct Use

- The input variable is not allowed to omit. An error will occur during the compiling of the software if the input variable is omitted. But the output variable is allowed to omit.
- The value of *Out* varies between $-\pi/2$ and $\pi/2$ when the value of *In* changes between -1.0 and 1.0. The instruction will not go to the error state if the value of *In* is out of -1.0 ~1.0 and the value of *Out* is nonnumeric as shown in the following table and program.

The variable table and program

Variable name	Data type	Current value
ASIN_EN	BOOL	TRUE
ASIN_In	REAL	2.0
Out1	LREAL	1.#QNAN

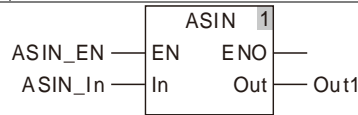

● Programming Example

- The data types of variables *ASIN_In* and *Out1* are REAL and LREAL respectively. The value of *Out1* is 1.5707963267949 if the value of *ASIN_In* is 1.0 when *ASIN_EN* changes to TRUE. The value of *Out1* is -1.5707963267949 as *ASIN_In* is -1.0.

➤ Variable 1

Variable name	Data type	Current value
ASIN_EN	BOOL	TRUE
ASIN_In	REAL	1.0
Out1	LREAL	1.5707963267949

➤ Variable 2

Variable name	Data type	Current value
ASIN_EN	BOOL	TRUE
ASIN_In	REAL	-1.0
Out1	LREAL	-1.5707963267949

➤ The program

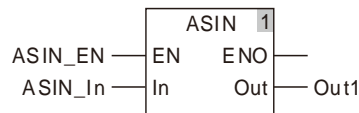

8.9.16 ACOS

FB/FC	Explanation	Applicable model
FC	ACOS is used to get the arc cosine of a number and the result is output to <i>Out</i> . The unit of <i>Out</i> is radian.	DVP15MC11T DVP15MC11T-06

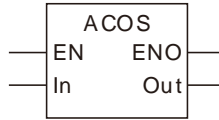

Parameters

Parameter name	Meaning	Input/Output	Description	Valid range
In	Number to process	Input	Number to process	Depends on the data type of the variable that the input parameter is connected to.
Out	Operation result	Output	Operation result	0 ~ π

	Boolean	Bit string					Integer						Real number		Time, date				String	
	BOOL	BYTE	WORD	DWORD	LWORD	USINT	UINT	UDINT	ULINT	SINT	INT	DINT	LINT	REAL	LREAL	TIME	DATE	TOD	DT	STRING
In		●	●	●	●	●	●	●	●	●	●	●	●	●						
Out														●						

Note:

The symbol ● indicates that the parameter is allowed to connect to the variable or constant of the data type.

Function Explanation

- ACOS is used to calculate the arc cosine of the input parameter *In* and the result is output to *Out*.

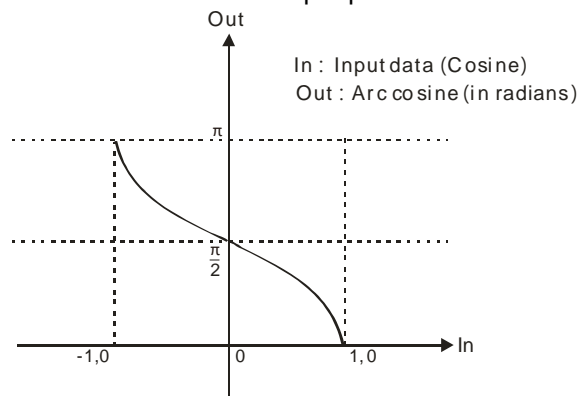

- Users can choose different data types for the input parameter in this instruction. But the data type of the output parameter is restricted to LREAL. An error will occur during the compiling of the software if the data type of the output parameter is not LREAL.

● **Precautions for Correct Use**

- The input variable is not allowed to omit. An error will occur during the compiling of the software if the input variable is omitted. But the output variable is allowed to omit.
- The value of *Out* varies between 0 and π when the value of *In* changes between -1.0 and 1.0. The instruction will not go to the error state if the value of *In* is out of -1.0 ~1.0 and the value of *Out* is nonnumeric.

The variable table and program

Variable name	Data type	Current value
ACOS_EN	BOOL	TRUE
ACOS_In	REAL	2.0
Out1	LREAL	1.#QNAN

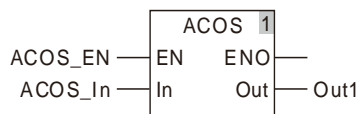

● **Programming Example**

- The data types of variables *ACOS_In* and *Out1* are REAL and LREAL respectively. The value of *Out1* is 0 if the value of *ACOS_In* is 1.0 when *ACOS_EN* changes to TRUE. The value of *Out1* is 3.14159265358979 as *ACOS_In* is -1.0.

➤ Variable

Variable name	Data type	Current value
ACOS_EN	BOOL	TRUE
ACOS_In	REAL	1.0
Out1	LREAL	0

➤ Variable

Variable name	Data type	Current value
ACOS_EN	BOOL	TRUE
ACOS_In	REAL	-1.0
Out1	LREAL	3.14159265358979

➤ The program

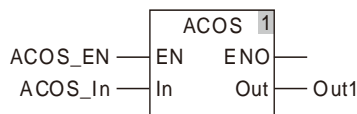

8.9.17 ATAN

FB/FC	Explanation	Applicable model
FC	ATAN is used to find the arc tangent of a number and the result is output to <i>Out</i> . The unit of <i>Out</i> is radian.	DVP15MC11T DVP15MC11T-06

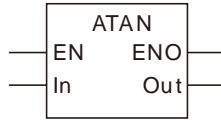

● Parameters

Parameter name	Meaning	Input/Output	Description	Valid range
In	Number to process	Input	Number to process	Depends on the data type of the variable that the input parameter is connected to.
Out	Operation result	Output	Operation result	$-\pi/2 \sim \pi/2$

	Boolean	Bit string					Integer						Real number		Time, date				String	
	BOOL	BYTE	WORD	DWORD	LWORD	USINT	UINT	UDINT	ULINT	SINT	INT	DINT	LINT	REAL	LREAL	TIME	DATE	TOD	DT	STRING
In		●	●	●	●	●	●	●	●	●	●	●	●	●	●					
Out														●						

Note:

The symbol ● indicates that the parameter is allowed to connect to the variable or constant of the data type.

● Function Explanation

- ATAN is used to calculate the arc tangent of the input parameter *In* and the result is output to *Out*.

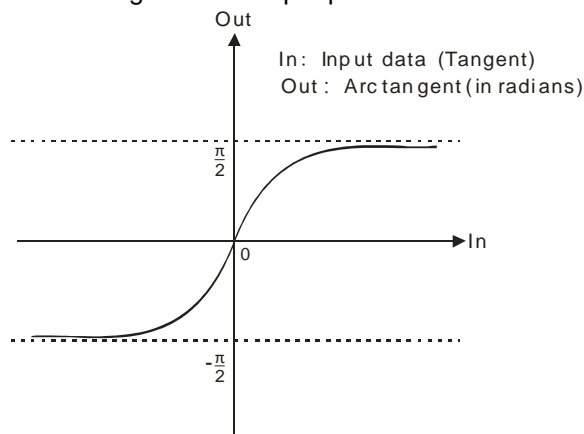

- Users can choose different data types for the input parameter in this instruction. But the data type of the output parameter is restricted to LREAL. An error will occur during the compiling of the software if the data type of the output parameter is not LREAL.

● **Precautions for Correct Use**

- The input variable is not allowed to omit. An error will occur during the compiling of the software if the input variable is omitted. But the output variable is allowed to omit.
- The output value of *Out* is $-\pi/2$ if the input value of *In* is $-\infty$. The output value of *Out* is $\pi/2$ if the input value of *In* is $+\infty$.

● **Programming Example**

- The data types of variables *ATAN_In* and *Out1* are REAL and LREAL respectively. The value of *Out1* is 0.785398163397448 if the value of *ATAN_In* is 1.0 when *ATAN_EN* changes to TRUE. The value of *Out1* is -0.785398163397448 as *ATAN_In* is -1.0.

➤ Variable 1

Variable name	Data type	Current value
ATAN_EN	BOOL	TRUE
ATAN_In	REAL	1.0
Out1	LREAL	0.785398163397448

➤ Variable 2

Variable name	Data type	Current value
ATAN_EN	BOOL	TRUE
ATAN_In	REAL	-1.0
Out1	LREAL	-0.785398163397448

➤ The program

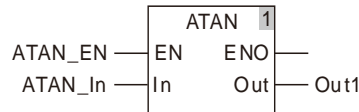

8.9.18 LN

FB/FC	Explanation	Applicable model
FC	LN is used to find the natural logarithm of a number and the result is output to <i>Out</i> .	DVP15MC11T DVP15MC11T-06

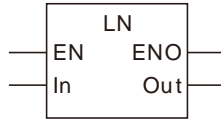

● **Parameters**

Parameter name	Meaning	Input/Output	Description	Valid range
In	Number to process	Input	Number to process	Depends on the data type of the variable that the input parameter is connected to.
Out	Logarithm	Output	The natural logarithm of <i>In</i>	Depends on the data type of the variable that the output parameter is connected to.

	Boolean	Bit string					Integer						Real number		Time, date			String		
	BOOL	BYTE	WORD	DWORD	LWORD	USINT	UINT	UDINT	ULINT	SINT	INT	DINT	LINT	REAL	LREAL	TIME	DATE	TOD	DT	STRING
In		●	●	●	●	●	●	●	●	●	●	●	●	●						
Out														●						

Note:

The symbol ● indicates that the parameter is allowed to connect to the variable or constant of the data type.

● **Function Explanation**

- LN is used to calculate the natural logarithm of the input parameter *In*, that is the logarithm with *e* ($e=2.718282$) as the base, and the result is output to *Out*.

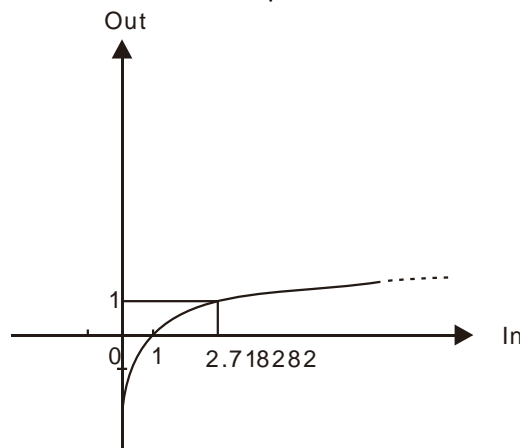

- Users can choose different data types for the input parameter in this instruction. But the data type of the output parameter is restricted to LREAL. An error will occur during the compiling of the software if the data type of the output parameter is not LREAL.

● Precautions for Correct Use

- The input variable is not allowed to omit. An error will occur during the compiling of the software if the input variable is omitted. But the output variable is allowed to omit.
- The output value of *Out* is nonnumeric when the input value of *In* is a non-positive number as shown in the following table.

The variable table and program

Variable name	Data type	Current value
LN_EN	BOOL	TRUE
LN_In	REAL	-2.0
Out1	LREAL	1.#QNAN

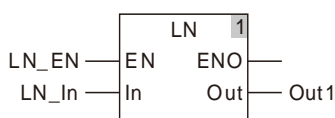

● Programming Example

- The data types of variables *LN_In* and *Out1* are INT and LREAL respectively. The value of *Out1* is 0.0 if the value of *LN_In* is 1 when *LN_EN* changes to TRUE. The value of *Out1* is 1.00000005734143 as *LN_In* is 2.718282.

➤ Variable 1

Variable name	Data type	Current value
LN_EN	BOOL	TRUE
LN_In	INT	1
Out1	LREAL	0.0

➤ Variable 2

Variable name	Data type	Current value
LN_EN	BOOL	TRUE
LN_In	REAL	2.718282
Out1	LREAL	1.00000005734143

➤ The program

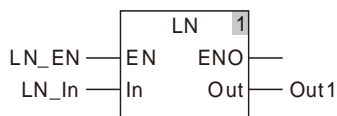

8.9.19 LOG

FB/FC	Explanation	Applicable model
FC	LOG is used to find the base-10 logarithm of a number and the result is output to <i>Out</i> .	DVP15MC11T DVP15MC11T-06

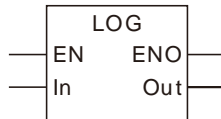

● Parameters

Parameter name	Meaning	Input/Output	Description	Valid range
In	Number to process	Input	Number to process	Depends on the data type of the variable that the input parameter is connected to.
Out	Logarithm	Output	The base-10 logarithm	Depends on the data type of the variable that the output parameter is connected to.

	Boolean	Bit string					Integer						Real number		Time, date			String		
	BOOL	BYTE	WORD	DWORD	LWORD	USINT	UINT	UDINT	ULINT	SINT	INT	DINT	LINT	REAL	LREAL	TIME	DATE	TOD	DT	STRING
In		●	●	●	●	●	●	●	●	●	●	●	●	●						
Out														●						

Note:

The symbol ● indicates that the parameter is allowed to connect to the variable or constant of the data type.

● Function Explanation

- LOG is used to calculate the base-10 logarithm of the input parameter *In* and the result is output to *Out*.

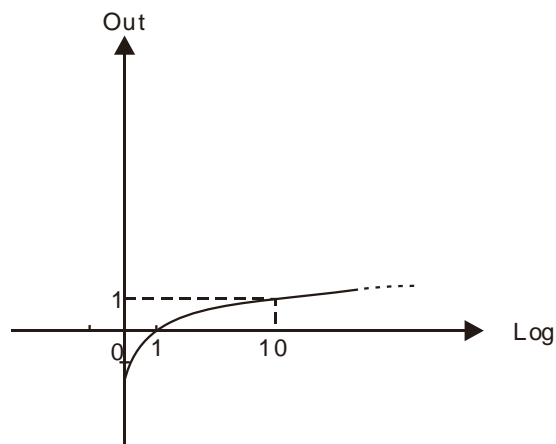

- Users can choose different data types for the input parameter in this instruction. But the data type of the output parameter is restricted to LREAL. An error will occur during the compiling of the software if the data type of the output parameter is not LREAL.

● Precautions for Correct Use

- The input variable is not allowed to omit. An error will occur during the compiling of the software if the input variable is omitted. But the output variable is allowed to omit.
- The output value of *Out* is a nonnumeric value when the input value of *In* is a non-positive number as shown in the following table.

The variable table and program

Variable name	Data type	Current value
LOG_EN	BOOL	TRUE
LOG_In	REAL	-2.0
Out1	LREAL	1.#QNAN

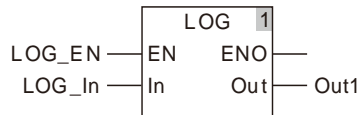

● Programming Example

- The data types of variables *LOG_In* and *Out1* are INT and LREAL respectively. The value of *Out1* is 0.0 if the value of *LOG_In* is 1 when *LOG_EN* changes to TRUE. The value of *Out1* is 1.0 as *LOG_In* is 10.

➤ Variable 1

Variable name	Data type	Current value
LOG_EN	BOOL	TRUE
LOG_In	INT	1
Out1	LREAL	0.0

➤ Variable 2

Variable name	Data type	Current value
LOG_EN	BOOL	TRUE
LOG_In	INT	10
Out1	LREAL	1.0

➤ The program

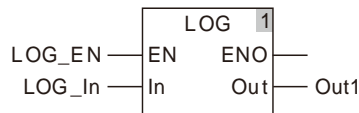

8.9.20 SQRT

FB/FC	Explanation	Applicable model
FC	SQRT is used to calculate the square root of a number and the result is output to <i>Out</i> .	DVP15MC11T DVP15MC11T-06

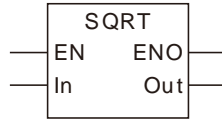

● Parameters

Parameter name	Meaning	Input/Output	Description	Valid range
In	Number to process	Input	Number to process	Depends on the data type of the variable that the input parameter is connected to. And it is a non-negative number.
Out	Square root	Output	Square root	Depends on the data type of the variable that the output parameter is connected to. And it is a non-negative number.

	Boolean	Bit string					Integer						Real number		Time, date				String	
	BOOL	BYTE	WORD	DWORD	LWORD	USINT	UINT	UDINT	ULINT	SINT	INT	DINT	LINT	REAL	LREAL	TIME	DATE	TOD	DT	STRING
In		●	●	●	●	●	●	●	●	●	●	●	●	●						
Out														●						

Note:

The symbol ● indicates that the parameter is allowed to connect to the variable or constant of the data type.

● Function Explanation

- SQRT is used to calculate the square root of *In* and the result is output to *Out*.

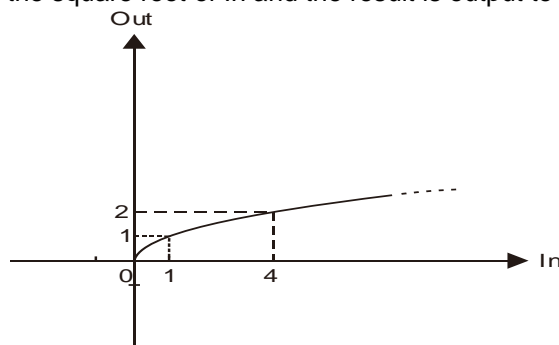

- Users can choose different data types for the input parameter in this instruction. But the data type of the output parameter is restricted to LREAL. An error will occur during the compiling of the software if the data type of the output parameter is not LREAL.

● Precautions for Correct Use

- The input variable is not allowed to omit. An error will occur during the compiling of the software if the input variable is omitted. But the output variable is allowed to omit.
- The output value of *Out* is a nonnumeric value when the input value of *In* is a negative number.

The variable table and program

Variable name	Data type	Current value
SQRT_EN	BOOL	TRUE
SQRT_In	REAL	-2.0
Out1	LREAL	1.#QNAN

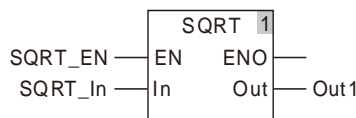

● Programming Example

- The data types of variables *SQRT_In* and *Out1* are INT and LREAL respectively. The value of *Out1* is 4.0 if the value of *SQRT_In* is 16 when *SQRT_EN* changes to TRUE. The value of *Out1* is 10.0 as *SQRT_In* is 100.

➤ Variable 1

Variable name	Data type	Current value
SQRT_EN	BOOL	TRUE
SQRT_In	INT	16
Out1	LREAL	4.0

➤ Variable 2

Variable name	Data type	Current value
SQRT_EN	BOOL	TRUE
SQRT_In	INT	100
Out1	LREAL	10.0

➤ The program

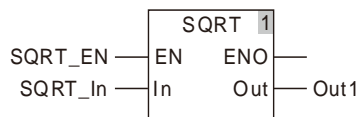

8.9.21 EXP

FB/FC	Explanation	Applicable model
FC	EXP is used to perform the operation with e as the base number and In as the exponent. The result is output to Out .	DVP15MC11T DVP15MC11T-06

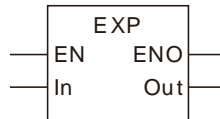

● Parameters

Parameter name	Meaning	Input/Output	Description	Valid range
In	Exponent	Input	Exponent	Depends on the data type of the variable that the input parameter is connected to.
Out	Operation result	Output	Operation result with the base number e and exponent In	Depends on the data type of the variable that the output parameter is connected to. And it is a non-negative number.

	Boolean	Bit string					Integer						Real number		Time, date			String		
	BOOL	BYTE	WORD	DWORD	LWORD	USINT	UINT	UDINT	ULINT	SINT	INT	DINT	LINT	REAL	LREAL	TIME	DATE	TOD	DT	STRING
In		●	●	●	●	●	●	●	●	●	●	●	●	●						
Out														●						

Note:

The symbol ● indicates that the parameter is allowed to connect to the variable or constant of the data type.

● Function Explanation

- EXP is used to perform the operation with e ($e=2.718282$) as the base number and In as the exponent. The result is output to Out .

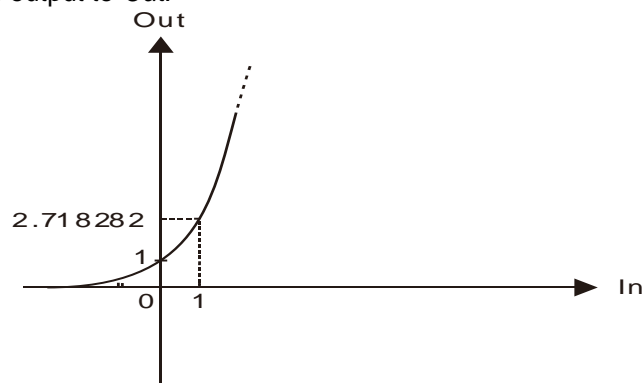

- Users can choose different data types for the input parameter in this instruction. But the data type of the output parameter is restricted to LREAL. An error will occur during the compiling of the software if the data type of the output parameter is not LREAL.

● Precautions for Correct Use

- The input variable is not allowed to omit. An error will occur during the compiling of the software if the input variable is omitted. But the output variable is allowed to omit.
- When the value of *In* is 0, +∞, -∞ and a nonnumeric value, the corresponding output values of *Out* is listed in the following table.

In	Out
0	1.0
+∞	+∞
-∞	0.0
nonnumeric	nonnumeric

● Programming Example

- The data types of *EXP_In* and *Out1* are INT and LREAL respectively. The value of *Out1* is 1.0 if the value of *EXP_In* is 0 when *EXP_EN* changes to TRUE. And the value of *Out1* is 2.71828182845905 as *EXP_In* is 1.

➤ Variable 1

Variable name	Data type	Current value
EXP_EN	BOOL	TRUE
EXP_In	INT	0
Out1	LREAL	1.0

➤ Variable 2

Variable name	Data type	Current value
EXP_EN	BOOL	TRUE
EXP_In	INT	1
Out1	LREAL	2.71828182845905

➤ The program

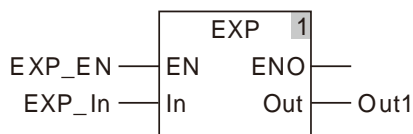

8.9.22 EXPT

FB/FC	Explanation	Applicable model
FC	EXPT is used to perform the exponentiation operation with <i>In</i> as the base number and <i>Pwr</i> as the exponent. The result is output to <i>Out</i> .	DVP15MC11T DVP15MC11T-06

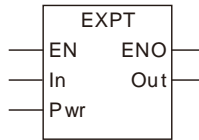

● Parameters

Parameter name	Meaning	Input/Output	Description	Valid range
In	Base number	Input	Base number	Depends on the data type of the variable that the input parameter is connected to.
Pwr	Exponent	Input	Exponent	Depends on the data type of the variable that the input parameter is connected to.
Out	Calculation result	Output	Operation result with <i>In</i> as the base number and <i>Pwr</i> as the exponent	Depends on the data type of the variable that the output parameter is connected to.

	Boolean	Bit string					Integer						Real number		Time, date				String	
	BOOL	BYTE	WORD	DWORD	LWORD	USINT	UINT	UDINT	ULINT	SINT	INT	DINT	LINT	REAL	LREAL	TIME	DATE	TOD	DT	STRING
In		●	●	●	●	●	●	●	●	●	●	●	●	●						
Pwr		●	●	●	●	●	●	●	●	●	●	●	●	●						
Out														●						

Note:

The symbol ● indicates that the parameter is allowed to connect to the variable or constant of the data type.

● Function Explanation

- EXPT is used to perform the exponentiation operation with *In* as the base number and *Pwr* as the exponent. And the result is output to *Out*.
- Users can choose different data types for the input parameter in this instruction. But the data type of the output parameter is restricted to LREAL. An error will occur during the compiling of the software if the data type of the output parameter is not LREAL.

● Precautions for Correct Use

- The input variable is not allowed to omit. An error will occur during the compiling of the software if the input variable is omitted. But the output variable is allowed to omit.

● **Programming Example**

- The data types of variables *EXPT_In* and *EXPT_Pwr* are both INT with their respective values 10 and 2. The data type of *Out1* is LREAL. Then the value of *Out1* is 100.0 when *EXPT_EN* changes to TRUE. The value of *Out1* is 100.0 as the values of *EXPT_In* and *EXPT_Pwr* are -10 and 2 respectively.

➤ Variable 1

Variable name	Data type	Current value
EXPT_EN	BOOL	TRUE
EXPT_In	INT	10
EXPT_Pwr	INT	2
Out1	LREAL	100.0

➤ Variable 2

Variable name	Data type	Current value
EXPT_EN	BOOL	TRUE
EXPT_In	INT	-10
EXPT_Pwr	INT	2
Out1	LREAL	100.0

➤ The program

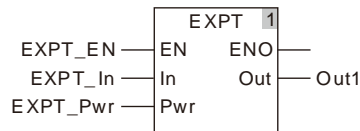

8.9.23 RAND

FB/FC	Explanation	Applicable model
FC	RAND is used to generate a random number.	DVP15MC11T DVP15MC11T-06

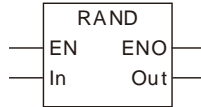

● Parameters

Parameter name	Meaning	Input/Output	Description	Valid range
In	Reserved	Input	Reserved	Depends on the data type of the variable that the input parameter is connected to.
Out	Random number	Output	Random number	Depends on the data type of the variable that the output parameter is connected to.

	Boolean	Bit string					Integer						Real number		Time, date			String		
	BOOL	BYTE	WORD	DWORD	LWORD	USINT	UINT	UDINT	ULINT	SINT	INT	DINT	LINT	REAL	LREAL	TIME	DATE	TOD	DT	STRING
In1								●												
Out												●								

Note:

The symbol ● indicates that the parameter is allowed to connect to the variable or constant of the data type.

● Function Explanation

- RAND is used to generate a random number and the result is output to *Out*, within the range $0 \sim 32767$.
- The input value does not have any effect on the random number to generate. But the value must be input for *In*.
- To get the random number within a specific range, users just need perform the MOD calculation over the generated value and get the remainder. For example, the random number between 0 and 10 can be generated by writing the program `RAND(0) MOD 10`.

● Precautions for Correct Use

- The input variable is not allowed to omit. An error will occur during the compiling of the software if the input variable is omitted. But the output variable is allowed to omit.

● **Programming Example**

- A random number is generated by writing RAND(0) as below.
The variable table and program

Variable name	Data type	Current value
RAND_EN	BOOL	TRUE
RAND_In	INT	0
Out1	DINT	256

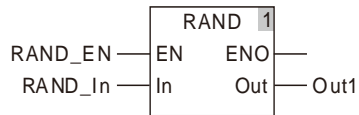

8.9.24 TRUNC

FB/FC	Explanation	Applicable model
FC	TRUNC is used to get the integral part of a real number.	DVP15MC11T DVP15MC11T-06

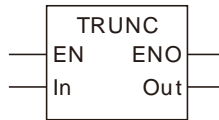

● Parameters

Parameter name	Meaning	Input/Output	Description	Valid range
In	Real number to convert	Input	Real number whose integer part is got	Depends on the data type of the variable that the input parameter is connected to.
Out	Conversion result	Output	Integral part of a real number	Depends on the data type of the variable that the output parameter is connected to.

	Boolean	Bit string					Integer							Real number		Time, date			String	
	BOOL	BYTE	WORD	DWORD	LWORD	USINT	UINT	UDINT	ULINT	SINT	INT	DINT	LINT	REAL	LREAL	TIME	DATE	TOD	DT	STRING
In													●	●						
Out												●								

Note:

The symbol ● indicates that the parameter is allowed to connect to the variable or constant of the data type.

● Function Explanation

- TRUNC is used to get the integral part of a real number and the result is output to *Out*.
- Users can choose different data types for the input parameter in this instruction. But the data type of the output parameter is only LINT. An error will occur during the compiling of the software if the data type of the output parameter is not LINT.

● Precautions for Correct Use

- The input variable is not allowed to omit. An error will occur during the compiling of the software if the input variable is omitted. But the output variable is allowed to omit.

● **Programming Example**

- The data type of *TRUNC_In* is REAL with the value -5.6. The data type of *Out1* is LINT. Then the value of *Out1* is -5 when *TRUNC_EN* changes to TRUE. And the value of *Out1* is 10 as the values of *TRUNC_In* 10.8.

➤ Variable 1

Variable name	Data type	Current value
TRUNC_EN	BOOL	TRUE
TRUNC_In	REAL	-5.6
Out1	LINT	-5

➤ Variable 2

Variable name	Data type	Current value
TRUNC_EN	BOOL	TRUE
TRUNC_In	REAL	10.8
Out1	LINT	10

➤ The program

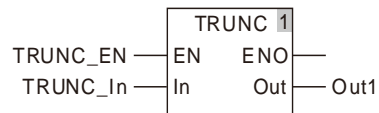

8.9.25 FLOOR

FB/FC	Explanation	Applicable model
FC	FLOOR is used to get the integral part of a real number. The output value is the integral part of the real number subtracted by 1 if the input real number is a negative number.	DVP15MC11T DVP15MC11T-06

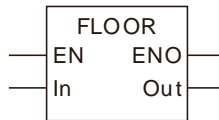

● Parameters

Parameter name	Meaning	Input/Output	Description	Valid range
In	Real number to convert	Input	Real number whose integer part is got	Depends on the data type of the variable that the input parameter is connected to.
Out	Conversion result	Output	Integer part of a real number	Depends on the data type of the variable that the output parameter is connected to.

	Boolean	Bit string					Integer						Real number		Time, date			String		
	BOOL	BYTE	WORD	DWORD	LWORD	USINT	UINT	UDINT	ULINT	SINT	INT	DINT	LINT	REAL	LREAL	TIME	DATE	TOD	DT	STRING
In													●	●						
Out												●								

Note:

The symbol ● indicates that the parameter is allowed to connect to the variable or constant of the data type.

● Function Explanation

- FLOOR is used to get the integral part of a real number and the result is output to *Out*. The output value is the integral part of the real number if the input real number is a positive number. For example, the output value is 3 if the input value is 3.5. The output value is the integral part of the real number subtracted by 1 if the input real number is a negative number. For example, the output value is -4 if the input value is -3.5.
- Users can choose different data types for the input parameter in this instruction. But the data type of the output parameter is restricted to LINT. An error will occur during the compiling of the software if the data type of the output parameter is not LINT.

● Precautions for Correct Use

- The input variable is not allowed to omit. An error will occur during the compiling of the software if the input variable is omitted. But the output variable is allowed to omit.

● **Programming Example**

- The data type of variable *FLOOR_In* is REAL with the value 5.6. The data type of *Out1* is LINT. Then the value of *Out1* is 5 when *FLOOR_EN* changes to TRUE. And the value of *Out1* is -11 as the values of *FLOOR_In* -10.2.

➤ Variable 1

Variable name	Data type	Current value
FLOOR_EN	BOOL	TRUE
FLOOR_In	REAL	5.6
Out1	LINT	5

➤ Variable 2

Variable name	Data type	Current value
FLOOR_EN	BOOL	TRUE
FLOOR_In	REAL	-10.2
Out1	LINT	-11

➤ The program

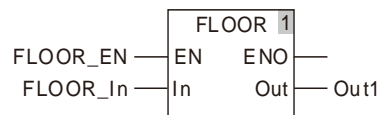

8.9.26 FRACTION

FB/FC	Explanation	Applicable model
FC	FRACTION is used to get the fraction part of a real number.	DVP15MC11T DVP15MC11T-06

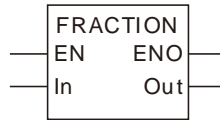

● Parameters

Parameter name	Meaning	Input/Output	Description	Valid range
In	Real number to convert	Input	Real number whose fraction part is got	Depends on the data type of the variable that the input parameter is connected to.
Out	Conversion result	Output	Fraction part of a real number	Depends on the data type of the variable that the output parameter is connected to.

	Boolean	Bit string					Integer						Real number		Time, date			String		
	BOOL	BYTE	WORD	DWORD	LWORD	USINT	UINT	UDINT	ULINT	SINT	INT	DINT	LINT	REAL	LREAL	TIME	DATE	TOD	DT	STRING
In														●	●					
Out															●					

Note:

The symbol ● indicates that the parameter is allowed to connect to the variable or constant of the data type.

● Function Explanation

- FRACTION is used to get the fraction part of a real number and the result is output to *Out*. The sign of the result value should be the same as that of the input value.
- Users can choose different data types for the input parameter in this instruction. But the data type of the output parameter is restricted to LREAL. An error will occur during the compiling of the software if the data type of the output parameter is not LREAL.

● Precautions for Correct Use

- The input variable is not allowed to omit. An error will occur during the compiling of the software if the input variable is omitted. But the output variable is allowed to omit.

● **Programming Example**

- The data type of variable *FRACTION_In* is REAL with the value -5.6. The data type of *Out1* is LREAL. Then the value of *Out1* is -0.6 when *FRACTION_EN* changes to TRUE. And the value of *Out1* is 0.8 as the values of *FRACTION_In* 10.8.

➤ Variable 1

Variable name	Data type	Current value
FRACTION_EN	BOOL	TRUE
FRACTION_In	REAL	-5.6
Out1	LREAL	-0.6

➤ Variable 2

Variable name	Data type	Current value
FRACTION_EN	BOOL	TRUE
FRACTION_In	REAL	10.8
Out1	LREAL	0.8

➤ The program

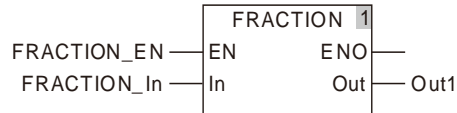

8.10 Bit String Instructions

8.10.1 AND

FB/FC	Explanation	Applicable model
FC	AND is used for performing a logical AND operation of two or more variables or constants.	DVP15MC11T DVP15MC11T-06

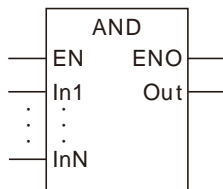

● Parameters

Parameter name	Meaning	Input/Output	Description	Valid range
In1 to InN	Operands	Input	The number of operands can be increased or decreased through the programming software. Maximum: 8. Minimum: 2. That is N=2 ~ 8.	Depends on the data type of the variable that the input parameter is connected to.
Out	Operation result	Output	AND operation result of In1 ~ InN	Depends on the data type of the variable that the output parameter is connected to.

	Boolean	Bit string				Integer							Real number		Time, date				String	
	BOOL	BYTE	WORD	DWORD	LWORD	USINT	UINT	UDINT	ULINT	SINT	INT	DINT	LINT	REAL	LREAL	TIME	DATE	TOD	DT	STRING
In1 to InN	●	●	●	●	●	●	●	●	●											
Out	●	●	●	●	●	●	●	●	●											

Note:

The symbol ● indicates that the parameter is allowed to connect to the variable or constant of the data type.

● Function Explanation

- AND is used for performing a bitwise logical AND operation of two or more variables or constants and the result is output to *Out*. That is $Out = In1 \& In2 \& \dots \& InN$

The operational rule:

The corresponding bit of the output variable is TRUE when corresponding bits of input variables are all TRUE as shown below. Otherwise, the corresponding bit of the output variable is FALSE.

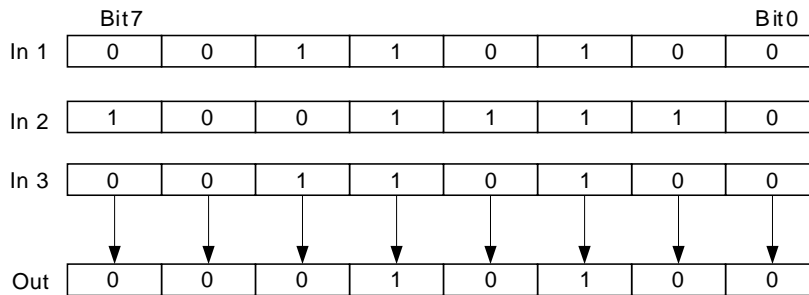

- *In1~InN* are allowed to be the variables of different data types when none of the data types of input variables are BOOL.

When *In1* to *InN* are the variables of different data types, take the data type which can include all ranges of the values of *In1~InN* for the operation.

For example, if the data type of *In1* is BYTE and *In2* is WORD, the data type of *Out* is WORD. In operation, the value of *In1* is converted from BYTE to WORD as shown in the following figure.

Bit8~ Bit 15 are complemented and their values are all 0. And then the logical AND of the bit values of *In1* and *In2* is conducted as below.

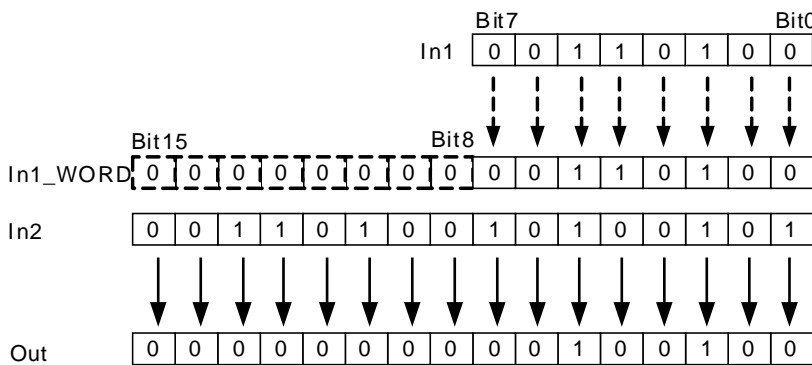

- If the data type of an input variable is BOOL, the data types of all input and output variables are required to be BOOL. Otherwise, an error will occur in the compiling of the software.

● **Precautions for Correct Use**

The input variables are not allowed to omit. An error will occur during the compiling of the software if any input variable is omitted. But the output variable is allowed to omit.

Programming Example

- The data types of AND_In1, AND_In2 and Out1 are all BYTE. The values of AND_In1 and AND_In2 are 10 and 50 respectively and the value of Out1 is 2 when AND_EN is TRUE.

➤ **The variable table and program**

Variable name	Data type	Current value
AND_EN	BOOL	TRUE
AND_In1	BYTE	10
AND_In2	BYTE	50
Out1	BYTE	2

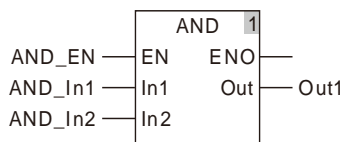

- The data types of AND_In1, AND_In2 and Out1 are BYTE, WORD and WORD respectively. The values of AND_In1 and AND_In2 are 255 and 256 respectively and the value of Out1 is 0 when AND_EN is TRUE.

➤ **The variable table and program**

Variable name	Data type	Current value
AND_EN	BOOL	TRUE
AND_In1	BYTE	255
AND_In2	WORD	256
Out1	WORD	0

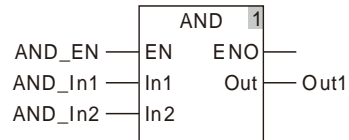

8.10.2 OR

FB/FC	Explanation	Applicable model
FC	OR is used for performing a logical OR operation of two or more variables or constants.	DVP15MC11T DVP15MC11T-06

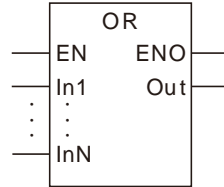

● **Parameters**

Parameter name	Meaning	Input/Output	Description	Valid range
In1 to InN	Operand	Input	The number of operands can be increased or decreased through the programming software. Maximum: 8. Minimum: 2. That is N=2 ~ 8.	Depends on the data type of the variable that the input parameter is connected to.
Out	Operation result	Output	OR operation result of In1 ~ InN	Depends on the data type of the variable that the output parameter is connected to.

	Boolean	Bit string					Integer						Real number		Time, date				String	
	BOOL	BYTE	WORD	DWORD	LWORD	USINT	UINT	UDINT	ULINT	SINT	INT	DINT	LINT	REAL	LREAL	TIME	DATE	TOD	DT	STRING
In1 to InN	●	●	●	●	●	●	●	●	●											
Out	●	●	●	●	●	●	●	●	●											

Note:

The symbol ● indicates that the parameter is allowed to connect to the variable or constant of the data type.

● **Function Explanation**

- OR is used for performing a bitwise logical OR operation of two or more variables or constants and the result is output to *Out*. That is $Out = In1 \text{ OR } In2 \text{ OR } \dots \text{ OR } InN$.

The operational rule:

When corresponding bits of all input variables are all FALSE, the corresponding bit of the output variable is FALSE. Otherwise, the corresponding bit of the output variable is TRUE.

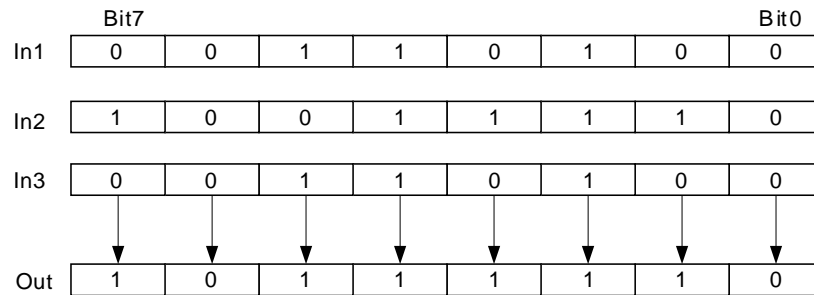

- *In1~InN* are allowed to be the variables of different data types when none of the data types of input variables are BOOL.

When *In1* to *InN* are the variables of different data types, take the data type which can include all ranges of the values of *In1~InN* for the operation.

For example, if the data type of *In1* is BYTE and *In2* is WORD, the data type of *Out* is WORD. In operation, the value of *In1* is converted from BYTE to WORD as shown in the following figure.

Bit8~ Bit 15 are complemented and their values are all 0. And then the logical OR of the bit values of *In1* and *In2* is conducted as below.

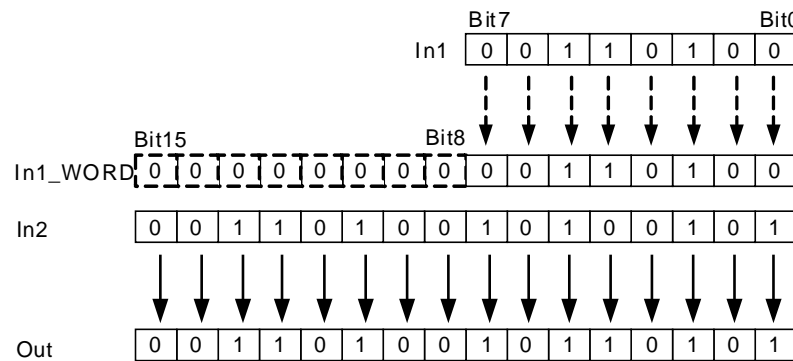

- If the data type of an input variable is BOOL, the data types of all input and output variables are required to be BOOL. Otherwise, an error will occur in the compiling of the software.

● **Precautions for Correct Use**

The input variables are not allowed to omit. An error will occur during the compiling of the software if any input variable is omitted. But the output variable is allowed to omit.



Programming Example

- The data types of OR_In1, OR_In2 and Out1 are all BYTE. The values of OR_In1 and OR_In2 are 10 and 50 respectively and the value of Out1 is 58 when OR_EN is TRUE.

➤ **The variable table and program**

Variable name	Data type	Current value
OR_EN	BOOL	TRUE
OR_In1	BYTE	10
OR_In2	BYTE	50
Out1	BYTE	58

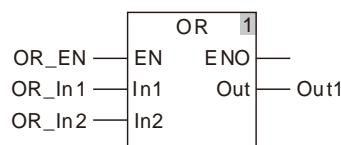

- The data types of OR_In1, OR_In2 and Out1 are BYTE, WORD and WORD respectively. The values of OR_In1 and OR_In2 are 255 and 256 respectively and the value of Out1 is 511 when OR_EN is TRUE.

➤ **The variable table and program**

Variable name	Data type	Current value
OR_EN	BOOL	TRUE
OR_In1	BYTE	255
OR_In2	WORD	256
Out1	WORD	511

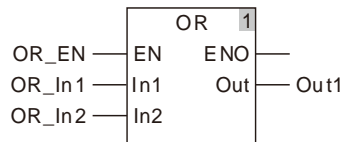

8.10.3 NOT

FB/FC	Explanation	Applicable model
FC	NOT is used for the NOT operation taking the inverse of a variable or constant.	DVP15MC11T DVP15MC11T-06

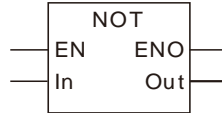

Parameters

Parameter name	Meaning	Input/Output	Description	Valid range
In	Operand	Input	Input parameter to take the inverse	Depends on the data type of the variable that the input parameter is connected to.
Out	Operation result	Output	Not operation result	Depends on the data type of the variable that the output parameter is connected to.

	Boolean	Bit string				Integer							Real number		Time, date				String		
	BOOL	BYTE	WORD	DWORD	LWORD	USINT	UINT	UDINT	ULINT	SINT	INT	DINT	LINT	REAL	LREAL	TIME	DATE	TOD	DT	STRING	
In	●	●	●	●	●	●	●	●	●												
Out	●	●	●	●	●	●	●	●	●												

Note:

The symbol ● indicates that the parameter is allowed to connect to the variable or constant of the data type.

Function Explanation

- NOT is used for the bitwise NOT operation taking the inverse of the value of a variable or constant and the result is output to *Out*.

The operational rule:

If one bit of the input variable is TRUE, the corresponding bit of the output variable is FALSE. If one bit of the input variable is FALSE, the corresponding bit of the output variable is TRUE.

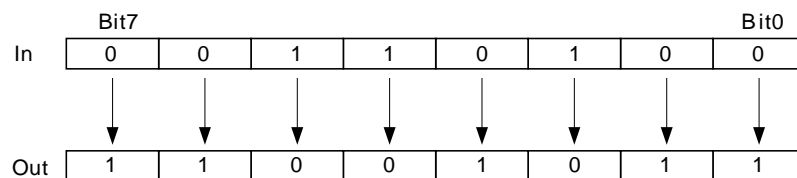

- The data type of *Out* must be the same as *In*.

Precautions for Correct Use

The input variables are not allowed to omit. An error will occur during the compiling of the software if any input variable is omitted. But the output variable is allowed to omit.



Programming Example

- The data types of NOT_In and Out1 are both BYTE. The value of In1 is 10 and the value of Out1 is 245 when NOT_EN is TRUE.

➤ **The variable table and program**

Variable name	Data type	Current value
NOT_EN	BOOL	TRUE
NOT_In	BYTE	10
Out1	BYTE	245

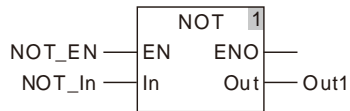

8.10.4 XOR

FB/FC	Explanation	Applicable model
FC	XOR is used for the XOR operation of two or more variables or constants.	DVP15MC11T DVP15MC11T-06

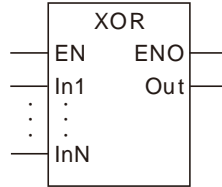

Parameters

Parameter name	Meaning	Input/Output	Description	Valid range
In1 to InN	Operand	Input	The number of operands can be increased or decreased through the programming software. Maximum: 8. Minimum: 2. That is N=2 ~ 8.	Depends on the data type of the variable that the input parameter is connected to.
Out	Operation result	Output	XOR operation result of In1 ~ InN	Depends on the data type of the variable that the output parameter is connected to.

	Boolean	Bit string					Integer						Real number		Time, date				String	
	BOOL	BYTE	WORD	DWORD	LWORD	USINT	UINT	UDINT	ULINT	SINT	INT	DINT	LINT	REAL	LREAL	TIME	DATE	TOD	DT	STRING
In1 to InN	●	●	●	●	●	●	●	●	●											
Out	●	●	●	●	●	●	●	●	●											

Note:

The symbol ● indicates that the parameter is allowed to connect to the variable or constant of the data type.

Function Explanation

XOR is used for the bitwise XOR operation of two or more variables or constants and the result is output to *Out*. That is $Out = In1 \text{ XOR } In2 \text{ XOR } \dots \text{ XOR } InN$.

The operational rule for XOR of In1 and In2 is shown in the following figure.

		Bit7								Bit0							
In1		0	0	1	1	0	1	0	0		1	0	1	1	0	1	0
In2		1	0	0	1	1	1	1	0		0	1	0	0	0	1	1
		↓	↓	↓	↓	↓	↓	↓	↓		↓	↓	↓	↓	↓	↓	↓
Out		1	0	1	0	1	0	1	0		1	0	1	1	0	1	0

- The steps for XOR operation when more than 2 input parameters exist are:

The XOR result of In1 and In2 is got first; then the XOR operation of the previous result and In3 is conducted and so on. Finally, the XOR operation of the previous XOR result and InN is processed. The XOR result of In1 and In2 is Out_Temp and the XOR result of Out_Temp and In3 is Out as shown below.

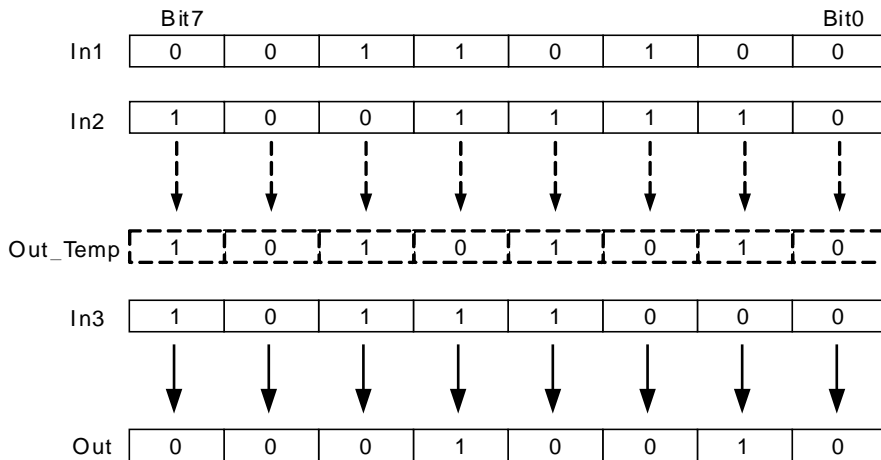

- *In1~InN* are allowed to be the variables of different data types when none of the data types of input variables are BOOL. When *In1* to *InN* are the variables of different data types, take the data type which can include all ranges of the values of *In1~InN* for the XOR operation. For example, if the data type of *In1* is BYTE and *In2* is WORD, the data type of *Out* is WORD. In operation, the value of *In1* is converted from BYTE to WORD as shown in the following figure. (Bit8~ Bit 15 are supplemented and their values are all 0.) And then the logical XOR of the bit values of *In1* and *In2* is conducted as below.

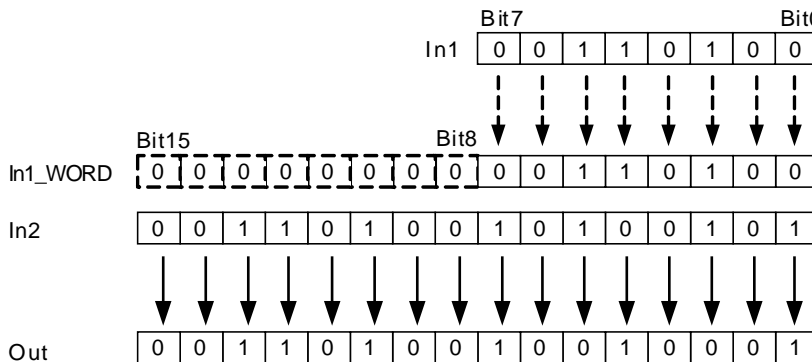

- If the data type of an input variable is BOOL, the data types of all input and output variables are required to be BOOL. Otherwise, an error will occur in the compiling of the software.

● **Precautions for Correct Use**

The input variables are not allowed to omit. An error will occur during the compiling of the software if any input variable is omitted. But the output variable is allowed to omit.



Programming Example

- The data types of XOR_In1, XOR_In2 and Out1 are all BYTE. The values of XOR_In1 and XOR_In2 are 10 and 50 and the value of Out1 is 56 when XOR_EN is TRUE as shown in Variable 1.

The data types of XOR_In1, XOR_In2 and Out1 are BYTE, WORD and WORD. The values of XOR_In1 and XOR_In2 are 255 and 256 and the value of Out1 is 511 when XOR_EN is TRUE as shown in Variable 2.

➤ **Variable 1**

Variable name	Data type	Current value
XOR_EN	BOOL	TRUE
XOR_In1	BYTE	10
XOR_In2	BYTE	50
Out1	BYTE	56

➤ **Variable 2**

Variable name	Data type	Current value
XOR_EN	BOOL	TRUE
XOR_In1	BYTE	255
XOR_In2	WORD	256
Out1	WORD	511

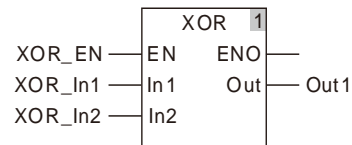
➤ **The program**

8.10.5 XORN

FB/FC	Explanation	Applicable model
FC	XORN is used for an XORN operation of two or more variables or constants.	DVP15MC11T DVP15MC11T-06

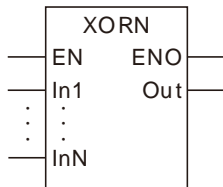

● **Parameters**

Parameter name	Meaning	Input/Output	Description	Valid range
In1 to InN	Operand	Input	The number of operands can be increased or decreased through the programming software. Maximum: 8. Minimum: 2. That is N=2 ~ 8.	Depends on the data type of the variable that the input parameter is connected to.
Out	Operation result	Output	XORN operation result of In1 ~ InN	Depends on the data type of the variable that the output parameter is connected to.

	Boolean	Bit string					Integer					Real number		Time, date				String		
	BOOL	BYTE	WORD	DWORD	LWORD	USINT	UINT	UDINT	ULINT	SINT	INT	DINT	LINT	REAL	LREAL	TIME	DATE	TOD	DT	STRING
In1 to InN	●	●	●	●	●	●	●	●	●											
Out	●	●	●	●	●	●	●	●	●											

Note:

The symbol ● indicates that the parameter is allowed to connect to the variable or constant of the data type.

● **Function Explanation**

XORN is used for a bitwise XORN of two or more variables or constants and the result is output to *Out*. That is $Out = In1 \text{ XORN } In2 \text{ XORN } \dots \text{ XORN } InN$.

The operational rule for XORN of In1 and In2 is shown in the following figure.

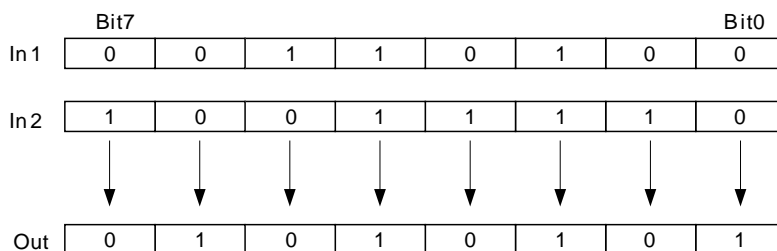

- The steps for XORN operation is for when more than 2 input parameters exist:

The XORN result of In1 and In2 is got first; then the XORN of the previous result and In3 is conducted and so on. Finally, the XORN of the previous XORN result and InN is processed. The XORN result of In1 and In2 is Out_Temp and the XORN result of Out_Temp and In3 is Out as shown below.

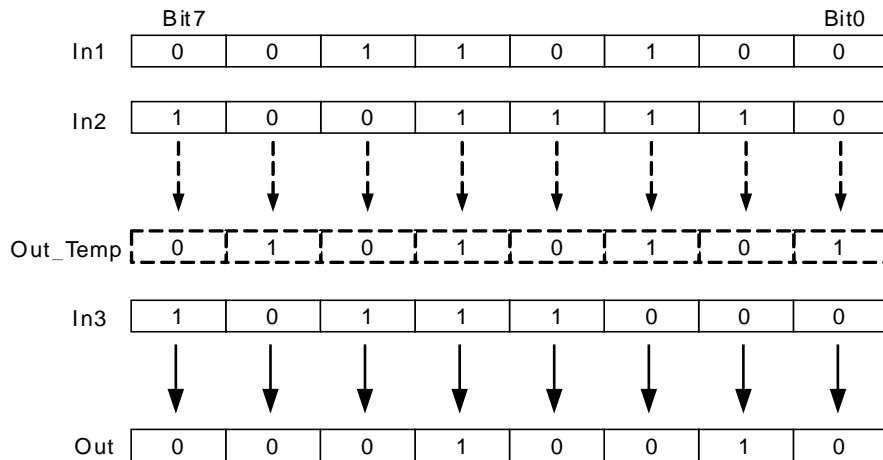

- *In1~InN* are allowed to be the variables of different data types when none of the data types of input variables are BOOL.

When *In1* to *InN* are the variables of different data types, take the data type which can include all ranges of the values of *In1~InN* for the operation.

For example, if the data type of *In1* is BYTE and *In2* is WORD, the data type of *Out* is WORD. In operation, the value of *In1* is converted from BYTE to WORD as shown in the following figure. (Bit8~ Bit 15 are supplemented and their values are all 0.) And then the logical XORN of the bit values of *In1* and *In2* is conducted as below.

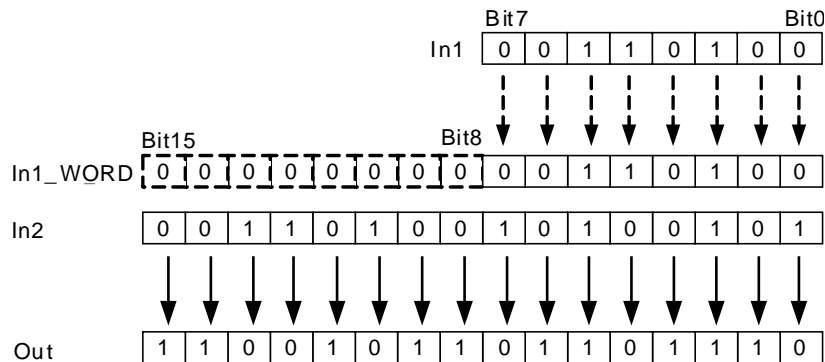

- If the data type of an input variable is BOOL, the data types of all input and output variables are required to be BOOL. Otherwise, an error will occur in the compiling of the software.

● Precautions for Correct Use

The input variables are not allowed to omit. An error will occur during the compiling of the software if any input variable is omitted. But the output variable is allowed to omit.



Programming Example

- The data types of XORN_In1, XORN_In2 and Out1 are all BYTE. The values of XORN_In1 and XORN_In2 are 10 and 50 and the value of Out1 is 199 when XORN_EN is TRUE as shown in Variable 1.

The data types of XORN_In1, XORN_In2 and Out1 are BYTE, WORD and WORD. The values of XORN_In1 and XORN_In2 are 255 and 256 and the value of Out1 is 65535 when XORN_EN is TRUE as shown in Variable 2.

➤ Variable 1

Variable name	Data type	Current value
XORN_EN	BOOL	TRUE
XORN_In1	BYTE	10
XORN_In2	BYTE	50
Out1	BYTE	199

➤ **Variable 2**

Variable name	Data type	Current value
XORN_EN	BOOL	TRUE
XORN_In1	BYTE	255
XORN_In2	WORD	256
Out1	WORD	65535

➤ **The program**

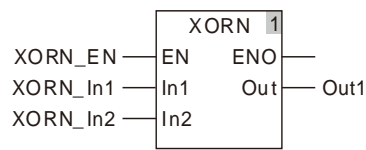

8.11 Shift Instructions

8.11.1 SHL

FB/FC	Explanation	Applicable model
FC	SHL is used to shift all bits of a variable or constant by the specified number of bits to the left and the result is output to Out.	DVP15MC11T DVP15MC11T-06

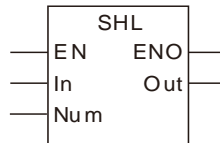

● Parameters

Parameter name	Meaning	Input/Output	Description	Valid range
In	Data to shift	Input	The original data to shift to the left	Depends on the data type of the variable that the input parameter is connected to.
Num	Number to shift	Input	The number of bits by which all bits of the original data are shifted to the left	Depends on the data type of the variable that the input parameter is connected to.
Out	Result	Output	Result from shifting all bits of the original data by the number of bits specified by Num to the left	Depends on the data type of the variable that the output parameter is connected to.

	Boolean	Bit string				Integer							Real number		Time, date			String			
	BOOL	BYTE	WORD	DWORD	LWORD	USINT	UINT	UDINT	ULINT	SINT	INT	DINT	LINT	REAL	LREAL	TIME	DATE	TOD	DT	STRING	
In		●	●	●	●	●	●	●	●												
Num						●															
Out	The data type of <i>Out</i> must be the same as <i>In</i> .																				

Note:

The symbol ● indicates that the parameter is allowed to connect to the variable or constant of the data type.

● Function Explanation

SHL is used to shift all bits of the value of *In* by the number of bits specified by *Num* to the left and the result is output to *Out*.

When $Num=2$, all bits of the value of In are shifted by two bits to the left and the values of Bit0~Bit1 are supplemented with 0 and Bit6~Bit7 are discarded as shown in the following figure.

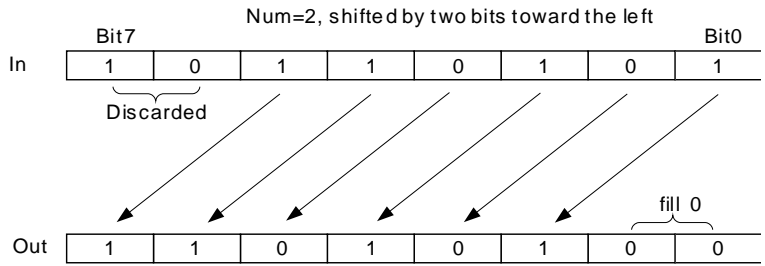

● **Precautions for Correct Use**

- The input variables are not allowed to omit. An error will occur during the compiling of the software if any input variable is omitted. But the output variable is allowed to omit.
- The value of Out is the same as In when the value of Num is 0.



Programming Example

- The data types of SHL_In and SHL_Num are UINT and USINT respectively and their values are 300 and 3 respectively. The data type of Out1 is BYTE and the value of Out1 is 2400 when SHL_EN is TRUE.

➤ **The variable table and program**

Variable name	Data type	Current value
SHL_EN	BOOL	TRUE
SHL_In	UINT	300
SHL_Num	USINT	3
Out1	UINT	2400

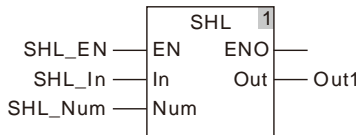

➤ **Illustration of the example**

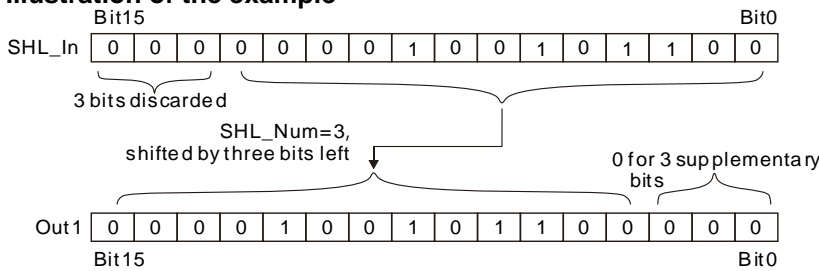

8.11.2 SHR

FB/FC	Explanation	Applicable model
FC	SHR is used to shift all bits of a variable or constant by the specified number of bits to the right and the result is output to <i>Out</i> .	DVP15MC11T DVP15MC11T-06

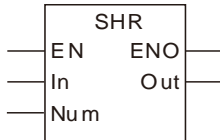

● **Parameters**

Parameter name	Meaning	Input/Output	Description	Valid range
In	Data to shift	Input	The original data to shift to the right	Depends on the data type of the variable that the input parameter is connected to.
Num	Number to shift	Input	The number of bits by which the bits of the original data are shifted to the right	Depends on the data type of the variable that the input parameter is connected to.
Out	Result	Output	Result from shifting all bits of the original data by the number of bits specified by Num to the right	Depends on the data type of the variable that the output parameter is connected to.

	Boolean	Bit string				Integer						Real number		Time, date			String				
	BOOL	BYTE	WORD	DWORD	LWORD	USINT	UINT	UDINT	ULINT	SINT	INT	DINT	LINT	REAL	LREAL	TIME	DATE	TOD	DT	STRING	
In		●	●	●	●	●	●	●	●												
Num						●															
Out	The data type of <i>Out</i> must be the same as <i>In</i> .																				

Note:

The symbol ● indicates that the parameter is allowed to connect to the variable or constant of the data type.

● **Function Explanation**

SHR is used to shift all bits of the value of *In* by the number of bits specified by *Num* to the right and the result is output to *Out*.

When $Num=2$, all bits of the value of In are shifted by two bits to the right and Bit0~Bit1 of In are discarded and the value of Bit6~Bit7 are supplemented with 0 as shown in the following figure.

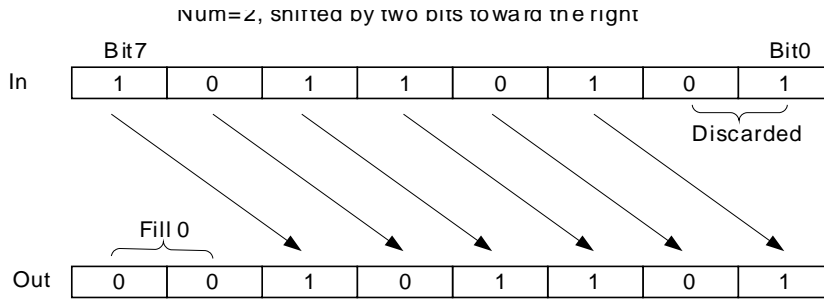

● **Precautions for Correct Use**

- The input variables are not allowed to omit. An error will occur during the compiling of the software if any input variable is omitted. But the output variable is allowed to omit.
- When the value of Num is 0, the value of Out is the same as In .



● **Programming Example**

- The data types of SHR_In and SHR_Num are $UINT$ and $USINT$ respectively and their values are 300 and 3 respectively. The data type of $Out1$ is $UINT$ and the value of $Out1$ is 37 when SHR_EN is $TRUE$.

➤ **The variable table and program**

Variable name	Data type	Current value
SHR_EN	BOOL	TRUE
SHR_In	UINT	300
SHR_Num	USINT	3
Out1	UINT	37

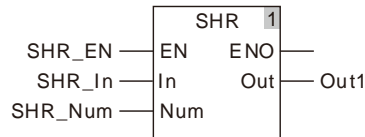

➤ **Illustration of the example**

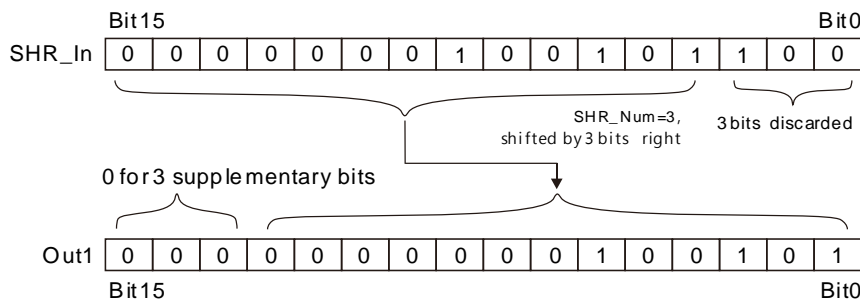

8.11.3 ROL

FB/FC	Explanation	Applicable model
FC	ROL is used to rotate left all bits of a variable or constant by the specified number of bits and the result is output to <i>Out</i> .	DVP15MC11T DVP15MC11T-06

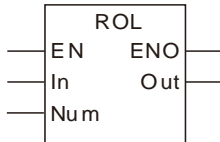

● **Parameters**

Parameter name	Meaning	Input/Output	Description	Valid range
In	Data to rotate	Input	The original data to rotate left	Depends on the data type of the variable that the input parameter is connected to.
Num	Number of bits	Input	The number of bits by which the bits of the original data are rotated to the left	Depends on the data type of the variable that the input parameter is connected to.
Out	Result	Output	Result from rotating all bits of the original data by the number of bits specified by Num to the left	Depends on the data type of the variable that the output parameter is connected to.

	Boolean	Bit string				Integer							Real number		Time, date			String		
	BOOL	BYTE	WORD	DWORD	LWORD	USINT	UINT	UDINT	ULINT	SINT	INT	DINT	LINT	REAL	LREAL	TIME	DATE	TOD	DT	STRING
In		●	●	●	●	●	●	●	●											
Num						●														
Out	The data type of <i>Out</i> must be the same as <i>In</i> .																			

Note:

The symbol ● indicates that the parameter is allowed to connect to the variable or constant of the data type.

● **Function Explanation**

ROL is used to rotate all bits of the value of *In* by the number of bits specified by *Num* to the left and the result is output to *Out*.

Via ROL, the bits shifted out of the left will shift to the null bits in the right one by one. When $Num=2$, all bits of the value of In rotates by two bits to the left. The rotation method is that Bit0~Bit5 are shifted to Bit2~Bit7 respectively, Bit 7 is shifted to Bit1 and Bit 6 is shifted to Bit0.

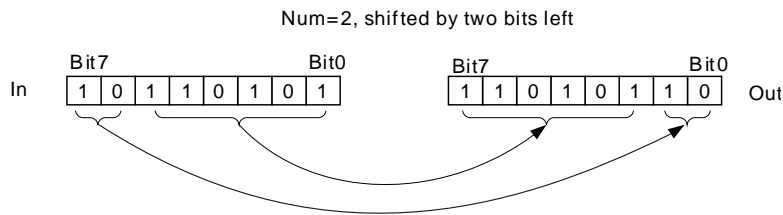

● **Precautions for Correct Use**

- The input variables are not allowed to omit. An error will occur during the compiling of the software if any input variable is omitted. But the output variable is allowed to omit.
- The value of Out is the same as In when the value of Num is 0.
- The number of bits by which the bits of original data are rotated left is equal to the value of $Num \text{ MOD } In$ when the value of Num is greater than the number of bits of the value of In .
For example, if the data type of In is BYTE, the value of out when $Num=USINT\#1$ is the same for when $Num=USINT\#9$.



Programming Example

- The data types of ROL_In and ROL_Num are UINT and USINT respectively and their values are 300 and 3 respectively. The data type of Out1 is BYTE and the value of Out1 is 2400 when ROL_EN is TRUE.

➤ **The variable table and program**

Variable name	Data type	Current value
ROL_EN	BOOL	TRUE
ROL_In	UINT	300
ROL_Num	USINT	3
Out1	UINT	2400

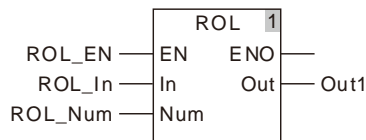

➤ **Illustration of the example**

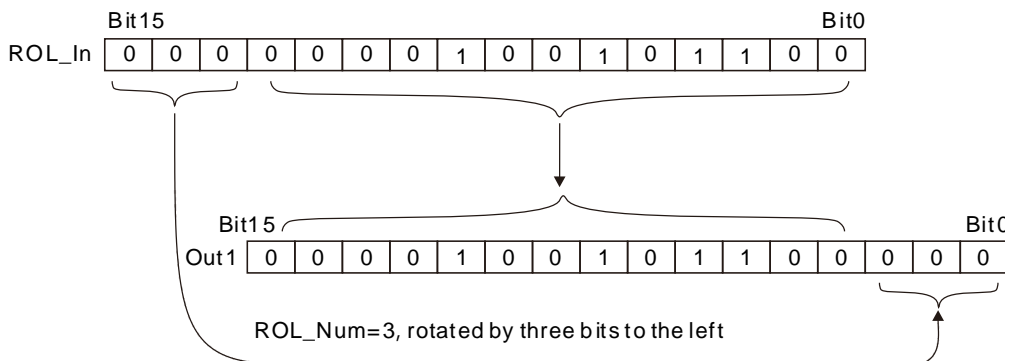

8.11.4 ROR

FB/FC	Explanation	Applicable model
FC	ROR is used to rotate all bits of a variable or constant by the specified number of bits to the right and the result is output to <i>Out</i> .	DVP15MC11T DVP15MC11T-06

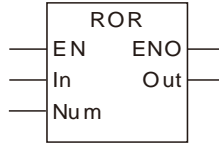

● Parameters

Parameter name	Meaning	Input/Output	Description	Valid range
In	Data to rotate	Input	The original data to rotate to the right	Depends on the data type of the variable that the input parameter is connected to.
Num	Number of bits	Input	The number of bits by which the bits of data are rotated to the right	Depends on the data type of the variable that the input parameter is connected to.
Out	Result	Output	Result from rotating all bits of the original data by the number of bits specified by Num to the right	Depends on the data type of the variable that the output parameter is connected to.

	Boolean	Bit string				Integer							Real number		Time, date			String		
	BOOL	BYTE	WORD	DWORD	LWORD	USINT	UINT	UDINT	ULINT	SINT	INT	DINT	LINT	REAL	LREAL	TIME	DATE	TOD	DT	STRING
In		●	●	●	●	●	●	●	●											
Num						●														
Out	The data type of <i>Out</i> must be the same as <i>In</i> .																			

Note:

The symbol ● indicates that the parameter is allowed to connect to the variable or constant of the data type.

● Function Explanation

ROR is used to rotate all bits of the value of *In* by the number of bits specified by *Num* to the right and the result is output to *Out*.

Via ROR, the bits shifted out of the right will shift to the null bits in the left one by one. When *Num*=2, all bits of the value of *In* rotates by two bits to the right. The rotation method is that Bit2~Bit7 are shifted to Bit0~Bit5 respectively, Bit0 is shifted to Bit6 and Bit1 is shifted to Bit7.

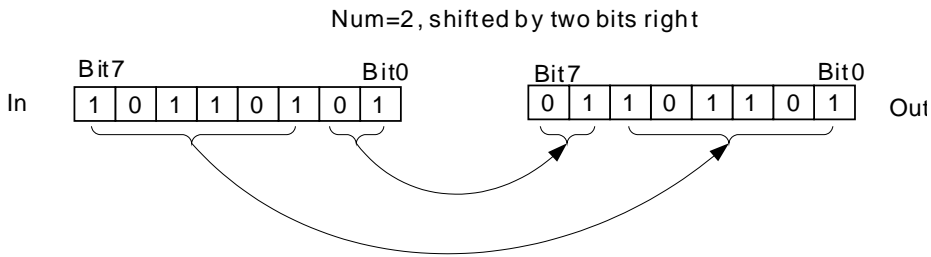

● **Precautions for Correct Use**

- The input variables are not allowed to omit. An error will occur during the compiling of the software if any input variable is omitted. But the output variable is allowed to omit.
- The value of *Out* is the same as *In* when the value of *Num* is 0.
- The number of bits by which the bits of data are rotated to the right is equal to the value of *Num* MOD *In* when the value of *Num* is greater than the number of bits of the value of *In*.
For example, if the data type of *In* is BYTE, the value of *out* when *Num*=USINT#1 is the same for when *Num*=USINT#9.



■ **Programming Example**

- The data types of ROR_In and ROR_Num are UINT and USINT respectively and their values are 300 and 3 respectively. The data type of Out1 is BYTE and the value of Out1 is 32805 when ROR_EN is TRUE.

➤ **The variable table and program**

Variable name	Data type	Current value
ROR_EN	BOOL	TRUE
ROR_In	UINT	300
ROR_Num	USINT	3
Out1	UINT	32805

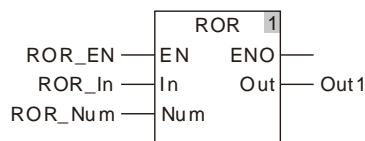

➤ **Illustration of the example**

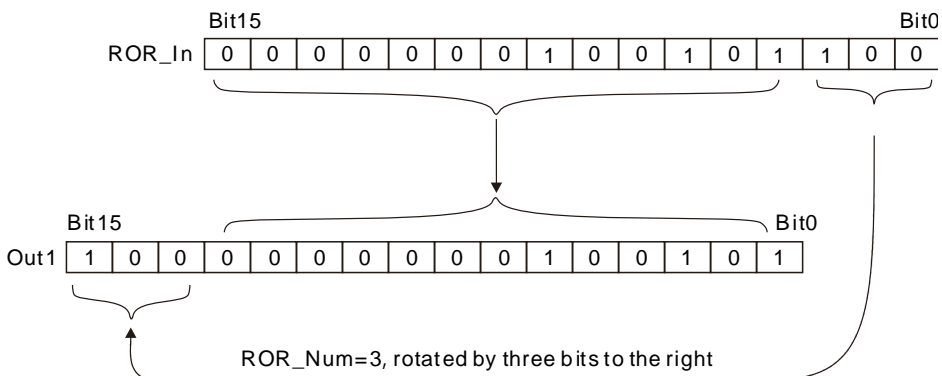

8.12 Selection Instructions

8.12.1 MAX

FB/FC	Explanation	Applicable model
FC	Max is used for finding the largest value of two or more variables or constants.	DVP15MC11T DVP15MC11T-06

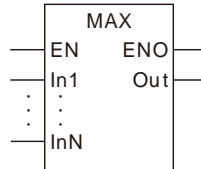

Parameters

Parameter name	Meaning	Input/Output	Description	Valid range
In1 to InN	Comparison data	Input	The comparison data can be added or removed while the program is being written. The maximum number of comparison data is 8. N=2~8	Depends on the data type of the variable that the input parameter is connected to.
Out	Comparison result	Output	The largest value of In1 ~ InN	Depends on the data type of the variable that the output parameter is connected to.

	Boolean	Bit string					Integer							Real number		Time, date				String
	BOOL	BYTE	WORD	DWORD	LWORD	USINT	UINT	UDINT	ULINT	SINT	INT	DINT	LINT	REAL	LREAL	TIME	DATE	TOD	DT	STRING
In1 to InN	●	●	●	●	●	●	●	●	●	●	●	●	●	●	●	●	●	●	●	●
Out	●	●	●	●	●	●	●	●	●	●	●	●	●	●	●	●	●	●	●	●

Note:

The symbol ● indicates that the parameter is allowed to connect to the variable or constant of the data type.

Function Explanation

- The Max instruction finds the largest value of two or more variables or constants and the largest value is output to *Out*.

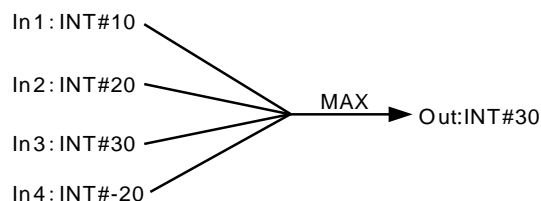

- When the data types of input variables are not BOOL, TIME, DATE, TOD or STRING, the input parameters *In1~InN* are allowed to be the variables of different data types.
- When the data types of input variables are one of BOOL, TIME, DATE, TOD and STRING, all the input variables and output variable should be of the data type. For example, if the data type of *In1* is TIME, the data type of *In2~InN* must be TIME. Otherwise, an error will occur during the compiling of the software.

● **Precautions for Correct Use**

- The input variables are not allowed to omit. An error will occur during the compiling of the software if the input variables are omitted. But the output variable is allowed to omit.
- The length of the data type of the output variable must contain the length of all input parameters. Otherwise, an error will occur during the compiling of the software



Programming Example

- The data types of MAX_In1, MAX_In2 and MAX_In3 are INT, UINT and DINT respectively. The data type of Out1 is DINT. If the values of MAX_In1, MAX_In2 and MAX_In3 are -10, 50 and 100 respectively, the value of Out1 is 100 when MAX_EN is TRUE.

➤ **The variable table and program**

Variable name	Data type	Current value
MAX_EN	BOOL	TRUE
MAX_In1	INT	- 10
MAX_In2	UINT	50
MAX_In3	DINT	100
Out1	DINT	100

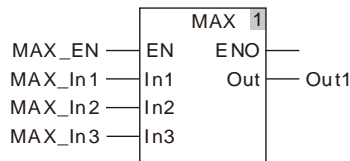

- The data types of MAX_In1 and MAX_In2 are TIME. The data type of Out1 is TIME. If the values of MAX_In1 and MAX_In2 are T#1ms and T#50ms respectively, the value of Out1 is T#50ms when MAX_EN is TRUE.

➤ **The variable table and program**

Variable name	Data type	Current value
MAX_EN	BOOL	TRUE
MAX_In1	TIME	T#1ms
MAX_In2	TIME	T#50ms
Out1	TIME	T#50ms

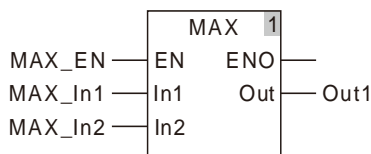

8.12.2 MIN

FB/FC	Explanation	Applicable model
FC	MIN is used for finding the smallest value of two or more variables or constants.	DVP15MC11T DVP15MC11T-06

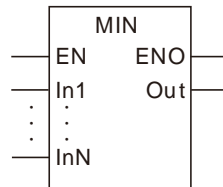

Parameters

Parameter name	Meaning	Input/Output	Description	Valid range
In1 to InN	Comparison data	Input	The comparison data can be added or removed while the program is being written. The maximum number of comparison data is 8. N=2~8.	Depends on the data type of the variable that the input parameter is connected to.
Out	Comparison result	Output	The smallest value of In1 ~ InN	Depends on the data type of the variable that the output parameter is connected to.

	Boolean	Bit string				Integer							Real number		Time, date				String	
	BOOL	BYTE	WORD	DWORD	LWORD	USINT	UINT	UDINT	ULINT	SINT	INT	DINT	LINT	REAL	LREAL	TIME	DATE	TOD	DT	STRING
In1 to InN	●	●	●	●	●	●	●	●	●	●	●	●	●	●	●	●	●	●	●	●
Out	●	●	●	●	●	●	●	●	●	●	●	●	●	●	●	●	●	●	●	●

Note:

The symbol ● indicates that the parameter is allowed to connect to the variable or constant of the data type. **Function Explanation**

- The MIN instruction finds the smallest value of two or more variables and constants and the smallest value is output to *Out*.

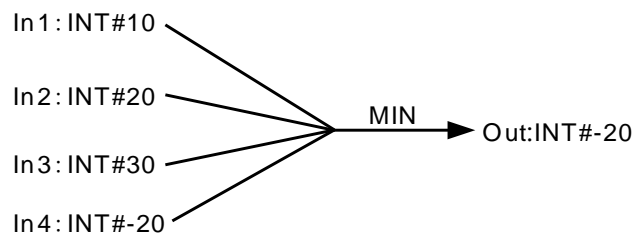

- When the data types of input variables are not BOOL, TIME, DATE, TOD or STRING, the input parameters *In1~InN* are allowed to be the variables of different data types.

- When the data types of input variables are one of BOOL, TIME, DATE, TOD and STRING, all the input variables and output variable should be of the data type. For example, if the data type of *In1* is TIME, the data type of *In2~InN* must be TIME. Otherwise, an error will occur during the compiling of the software.

● Precautions for Correct Use

- The input variables are not allowed to omit. An error will occur during the compiling of the software if the input variables are omitted. But the output variable is allowed to omit.
- The length of the data type of the output variable must contain the length of all input parameters. Otherwise, an error will occur during the compiling of the software.



Programming Example

- The data types of MIN_In1, MIN_In2 and MIN_In3 are INT, UINT and DINT respectively. The data type of Out1 is DINT. If the values of MIN_In1, MIN_In2 and MIN_In3 are -10, 50 and 100 respectively, the value of Out1 is -10 when MIN_EN is TRUE.

➤ **The variable table and program**

Variable name	Data type	Current value
MIN_EN	BOOL	TRUE
MIN_In1	INT	- 10
MIN_In2	UINT	50
MIN_In3	DINT	100
Out1	DINT	- 10

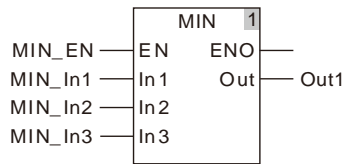

- The data types of MIN_In1 and MIN_In2 are TIME. The data type of Out1 is TIME. If the values of MIN_In1 and MIN_In2 are T#1ms and T#50ms respectively, the value of Out1 is T#1ms when MIN_EN is TRUE.

➤ **The variable table and program**

Variable name	Data type	Current value
MIN_EN	BOOL	TRUE
MIN_In1	TIME	T#1ms
MIN_In2	TIME	T#50ms
Out1	TIME	T#1ms

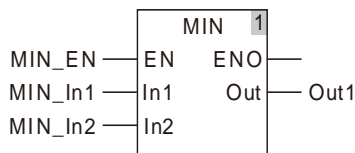

8.12.3 SEL

FB/FC	Explanation	Applicable model
FC	SEL is used for selecting one of two variables or constants and the selected value is output to <i>Out</i> .	DVP15MC11T DVP15MC11T-06

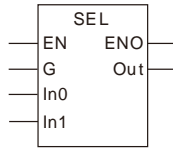

● **Parameters**

Parameter name	Meaning	Input/Output	Description	Valid range
G	Gate	Input	In0 is selected when G is FALSE; In1 is selected when G is TRUE.	Depends on the data type of the variable that the input parameter is connected to.
In0 and In1	Selections	Input	Data to be selected	Depends on the data type of the variable that the input parameter is connected to.
Out	Selection result	Output	Selection result	Depends on the data type of the variable that the output parameter is connected to.

	Boolean	Bit string					Integer							Real number		Time, date				String
	BOOL	BYTE	WORD	DWORD	LWORD	USINT	UINT	UDINT	ULINT	SINT	INT	DINT	LINT	REAL	LREAL	TIME	DATE	TOD	DT	STRING
G	●																			
In0 and In1	●	●	●	●	●	●	●	●	●	●	●	●	●	●	●	●	●	●	●	●
Out	●	●	●	●	●	●	●	●	●	●	●	●	●	●	●	●	●	●	●	●

Note:

The symbol ● indicates that the parameter is allowed to connect to the variable or constant of the data type.

● **Function Explanation**

- According to the selection condition G, the SEL instruction selects one of two variables or constants and the selection result is output to *Out*.

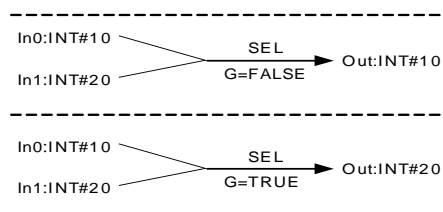

- When the data types of input variables are not BOOL, TIME, DATE, TOD or STRING, the input parameters *In0~In1* are allowed to connect the variables of different data types.
- When the data types of input variables are one of BOOL, TIME, DATE, TOD and STRING, all the input variables and output variable should be of the data type. For example, if the data type of the variable connected to *In0* is TIME, the data types of the variables connected to *In1* and *Out* must be TIME. Otherwise, an error will occur during the compiling of the software.

● **Precautions for Correct Use**

- The input variables are not allowed to omit. An error will occur during the compiling of the software if the input variables are omitted. But the output variable is allowed to omit.
- The length of the data type of the output variable must contain the length of the variables that the input parameters *In0* and *In1* connect. Otherwise, an error will occur during the compiling of the software.



Programming Example

- The data types of SEL_G, SEL_In0 and SEL_In1 are BOOL, UINT and DINT and the data type of Out1 is DINT. When SEL_EN is TRUE, the value of Out1 is 50 if the values of SEL_G, SEL_In0 and SEL_In1 are FALSE, 50 and 100 respectively as shown in the following table Variable 1. If the values of SEL_G, SEL_In0 and SEL_In1 are TRUE, 50 and 100 respectively, the value of Out1 is 100 as shown in the following table Variable 2.

➤ **Variable 1**

Variable name	Data type	Current value
SEL_EN	BOOL	TRUE
SEL_G	BOOL	FALSE
SEL_In0	UINT	50
SEL_In1	DINT	100
Out1	DINT	50

➤ **Variable 2**

Variable name	Data type	Current value
SEL_EN	BOOL	TRUE
SEL_G	BOOL	TRUE
SEL_In0	UINT	50
SEL_In1	DINT	100
Out1	DINT	100

■ **The program**

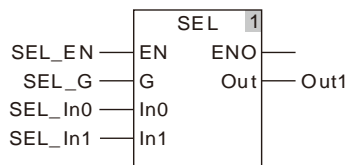

8.12.4 MUX

FB/FC	Explanation	Applicable model
FC	MUX is used for selecting one of two or more variables or constants and the result is output to <i>Out</i> .	DVP15MC11T DVP15MC11T-06

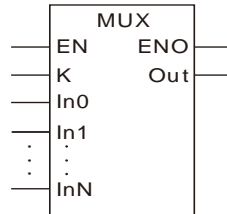

● Parameters

Parameter name	Meaning	Input/Output	Description	Valid range
K	Gate	Input	Gate	Depends on the data type of the variable that the input parameter is connected to.
In0, In1 to InN	Selections	Input	The selections can be added or removed while the program is being written. The maximum number of selections is 8. N=2~8.	Depends on the data type of the variable that the input parameter is connected to.
Out	Selection result	Output	Selection result	Depends on the data type of the variable that the output parameter is connected to.

	Boolean	Bit string				Integer							Real number		Time, date				String		
	BOOL	BYTE	WORD	DWORD	LWORD	USINT	UINT	UDINT	ULINT	SINT	INT	DINT	LINT	REAL	LREAL	TIME	DATE	TOD	DT	STRING	
K						●															
In0, In1 to InN	●	●	●	●	●	●	●	●	●	●	●	●	●	●	●	●	●	●	●	●	●
Out	●	●	●	●	●	●	●	●	●	●	●	●	●	●	●	●	●	●	●	●	●

Note:

The symbol ● indicates that the parameter is allowed to connect to the variable or constant of the data type.

● Function Explanation

- Based on the selection condition *K*, the MUX instruction selects one of *In0~InN* and the selection result is output to *Out*. The value of *Out* corresponds to the value of *K* as shown in the following table.

The value of K	The value of Out
0	In0
1	In1
2	In2
3	In3
4	In4
5	In5
6	In6
7	In7

- When the data types of input variables are not BOOL, TIME, DATE, TOD or STRING, the input parameters *In0~InN* are allowed to connect the variables of different data types.
- When the data types of input variables are one of BOOL, TIME, DATE, TOD and STRING, all the input variables and output variable should be of the data type. For example, if the data type of *In0* is TIME, the data types of the variables connected to *In1~InN* and *Out* must be TIME. Otherwise, an error will occur during the compiling of the software.

● **Precautions for Correct Use**

- The input variables are not allowed to omit. An error will occur during the compiling of the software if the input variables are omitted. But the output variable is allowed to omit.
- The length of the data type of the output variable must contain the length of the variables that the input parameters *In0 ~ InN* connect. Otherwise, an error will occur during the compiling of the software.



Programming Example

- The data types of MUX_K, MUX_In0 and MUX_In1 are UINT, UINT and DINT and the data type of Out1 is DINT. When MUX_EN is TRUE, the value of Out1 is 50 if the values of MUX_K, MUX_In0 and MUX_In1 are 0, 50 and 100 as shown in the following table Variable 1. If the values of MUX_K, MUX_In0 and MUX_In1 are 1, 50 and 100, the value of Out1 is 100 as shown in the following table Variable 2.

➤ **Variable 1**

Variable name	Data type	Current value
MUX_EN	BOOL	TRUE
MUX_K	USINT	0
MUX_In0	UINT	50
MUX_In1	DINT	100
Out1	DINT	50

➤ **Variable 2**

Variable name	Data type	Current value
MUX_EN	BOOL	TRUE
MUX_K	UINT	1
MUX_In0	UINT	50
MUX_In1	DINT	100
Out1	DINT	100

➤ **The program**

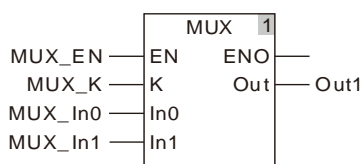

8.12.5 LIMIT

FB/FC	Explanation	Applicable model
FC	LIMIT is used for limiting the output value within the zone between the specified minimum and maximum values.	DVP15MC11T DVP15MC11T-06

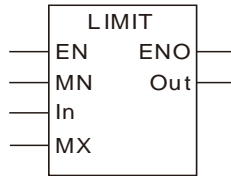

● Parameters

Parameter name	Meaning	Input/Output	Description	Valid range
MN	Minimum value	Input	Minimum value	Depends on the data type of the variable that the input parameter is connected to.
In	Data to limit	Input	Data to limit	Depends on the data type of the variable that the input parameter is connected to.
MX	Maximum value	Input	Maximum value	Depends on the data type of the variable that the input parameter is connected to.
Out	Processing result	Output	Processing result	Depends on the data type of the variable that the output parameter is connected to.

	Boolean	Bit string				Integer							Real number		Time, date				String	
	BOOL	BYTE	WORD	DWORD	LWORD	USINT	UINT	UDINT	ULINT	SINT	INT	DINT	LINT	REAL	LREAL	TIME	DATE	TOD	DT	STRING
MN		●	●	●	●	●	●	●	●	●	●	●	●	●	●					
In		●	●	●	●	●	●	●	●	●	●	●	●	●	●					
MX		●	●	●	●	●	●	●	●	●	●	●	●	●	●					
Out		●	●	●	●	●	●	●	●	●	●	●	●	●	●					

Note:

The symbol ● indicates that the parameter is allowed to connect to the variable or constant of the data type.

● Function Explanation

- LIMIT instruction limits the value within range between MN and MX and the result is output to *Out*.

The value of In	The value of Out
$In < MN$	MN
$MN \leq In \leq MX$	In
$MX < In$	MX

- The instruction allows input parameters *MN*, *In* and *MX* to connect the variables of different data types. When *MN*, *In* and *MX* are the variables of different data types, the calculation is performed with the data type which can contain the range of the values of *MN*, *In* and *MX*. For example, if the data type of *MN* is INT and the data types of *In* and *MX* are DINT, the data type of *Out* is DINT.
- The instruction allows the input parameters and the output parameter to connect the variables of different data types. But the length of the data type of the output variable must contain the length of the variables that the input parameters *In0* ~ *InN* connect. Otherwise, an error will occur during the compiling of the software.

● **Precautions for Correct Use**

- The input variables are not allowed to omit. An error will occur during the compiling of the software if the input variables are omitted. But the output variable is allowed to omit.



Programming Example

- The data types of LIMIT_MN, LIMIT_In and LIMIT_MX are UINT, UINT and DINT and the data type of Out1 is DINT. When LIMIT_EN is TRUE, the value of Out1 is 50 if the values of LIMIT_MN, LIMIT_In and LIMIT_MX are 1, 50 and 100 as shown in the following table Variable 1. If the values of LIMIT_MN, LIMIT_In and LIMIT_MX are 2, 200 and 100, the value of Out1 is 100 as shown in the following table Variable 2. If the values of LIMIT_MN, LIMIT_In and LIMIT_MX are 50, 10 and 100, the value of Out1 is 50 as shown in the following table Variable 3.

➤ **Variable 1**

Variable name	Data type	Current value
LIMIT_EN	BOOL	TRUE
LIMIT_MN	UINT	1
LIMIT_In	UINT	50
LIMIT_MX	DINT	100
Out1	DINT	50

➤ **Variable 2**

Variable name	Data type	Current value
LIMIT_EN	BOOL	TRUE
LIMIT_MN	UINT	2
LIMIT_In	UINT	200
LIMIT_MX	DINT	100
Out1	DINT	100

➤ **Variable 3**

Variable name	Data type	Current value
LIMIT_EN	BOOL	TRUE
LIMIT_MN	UINT	50
LIMIT_In	UINT	10
LIMIT_MX	DINT	100
Out1	DINT	50

➤ **The program**

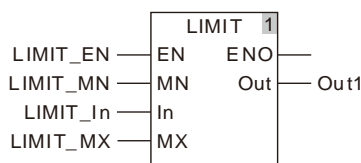

8.12.6 BAND

FB/FC	Explanation	Applicable model
FC	BAND performs the deadband control and the processing result is output to <i>Out</i> .	DVP15MC11T DVP15MC11T-06

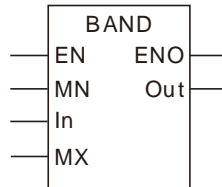

Parameters

Parameter name	Meaning	Input/Output	Description	Valid range
MN	Minimum value	Input	Minimum value	Depends on the data type of the variable that the input parameter is connected to.
In	Data to limit	Input	Data to limit	Depends on the data type of the variable that the input parameter is connected to.
MX	Maximum value	Input	Maximum value	Depends on the data type of the variable that the input parameter is connected to.
Out	Processing result	Output	Processing result	Depends on the data type of the variable that the output parameter is connected to.

	Boolean					Bit string							Integer					Real number		Time, date			String
	BOOL	BYTE	WORD	DWORD	LWORD	USINT	UINT	UDINT	ULINT	SINT	INT	DINT	LINT	REAL	LREAL	TIME	DATE	TOD	DT	STRING			
MN														●	●								
In														●	●								
MX														●	●								
Out														●	●								

Note:

The symbol ● indicates that the parameter is allowed to connect to the variable or constant of the data type.

● Function Explanation

- The BAND instruction performs the dead band control of the value of *In* according to the maximum value, *MX* and the minimum value, *MN* and the processing result is output to *Out*.

The value of In	The value of Out
$In < MN$	$In - MN$
$MN \leq In \leq MX$	0
$MX < In$	$In - MX$

- The instruction allows input parameters *MN*, *In* and *MX* to connect the variables of different data types. When *MN*, *In* and *MX* are the variables of different data types, the calculation is performed with the data type which can contain the range of the values of *MN*, *In* and *MX*. For example, if the data type of *MN* is REAL and the data types of *In* and *MX* are LREAL, the data type of *Out* is LREAL.
- The instruction allows the input parameters and the output parameter to connect the variables of different data types. But the length of the data type of the output variable must contain the length of the variables that the input parameters connect. Otherwise, an error will occur during the compiling of the software.

● Precautions for Correct Use

- The input variables are not allowed to omit. An error will occur during the compiling of the software if the input variables are omitted. But the output variable is allowed to omit.
- When the value of *MN* is greater than that of *MX*, the instruction will still be executed normally and the value of *Out* will be equal to that of *MX*.



Programming Example

- The data types of BAND_MN, BAND_In and BAND_MX are REAL and the data type of Out1 is LREAL. When BAND_EN is TRUE, the value of Out1 is 0 if the values of BAND_MN, BAND_In and BAND_MX are 1, 50 and 100 as shown in the following table Variable 1. If the values of BAND_MN, BAND_In and BAND_MX are 2, 250 and 100, the value of Out1 is 150 ($150=250-100$) as shown in the following table Variable 2. If the values of BAND_MN, BAND_In and BAND_MX are 50, 10 and 100, the value of Out1 is - 40 ($- 40 = 10 - 50$) as shown in the following table Variable 3.

➤ Variable 1

Variable name	Data type	Current value
BAND_EN	BOOL	TRUE
BAND_MN	REAL	1
BAND_In	REAL	50
BAND_MX	REAL	100
Out1	LREAL	0

➤ Variable 2

Variable name	Data type	Current value
BAND_EN	BOOL	TRUE
BAND_MN	REAL	2
BAND_In	REAL	250
BAND_MX	REAL	100
Out1	LREAL	150

➤ Variable 3

Variable name	Data type	Current value
BAND_EN	BOOL	TRUE
BAND_MN	REAL	50

Variable name	Data type	Current value
BAND_In	REAL	10
BAND_MX	REAL	100
Out1	LREAL	-40

➤ **The program**

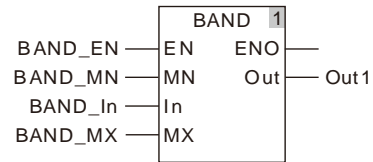

8.12.7 ZONE

FB/FC	Explanation	Applicable model
FC	ZONE is used for adding a bias value to the input value and the processing result is output to <i>Out</i> .	DVP15MC11T DVP15MC11T-06

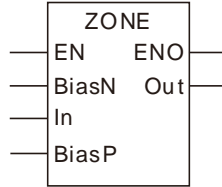

● Parameters

Parameter name	Meaning	Input/Output	Description	Valid range
BiasN	Negative bias value	Input	Negative bias	Depends on the data type of the variable that the input parameter is connected to.
In	Data to control	Input	Data to control	Depends on the data type of the variable that the input parameter is connected to.
BiasP	Positive bias value	Input	Positive bias	Depends on the data type of the variable that the input parameter is connected to.
Out	Processing result	Output	Processing result	Depends on the data type of the variable that the output parameter is connected to.

	Boolean	Bit string					Integer						Real number		Time, date				String		
	BOOL	BYTE	WORD	DWORD	LWORD	USINT	UINT	UDINT	ULINT	SINT	INT	DINT	LINT	REAL	LREAL	TIME	DATE	TOD	DT	STRING	
Bias N														●	●						
In														●	●						
Bias P														●	●						
Out														●	●						

Note:

The symbol ● indicates that the parameter is allowed to connect to the variable or constant of the data type.

● Function Explanation

- The ZONE instruction adds the set bias value to the value of *In* and the processing result is output to *Out*. When the value of *In* is a negative value, *BiasN* is the bias value. When the value of *In* is a positive value, *BiasP* is the bias value.

The value of In	The value of Out
In<0	In+BiasN
In=0	0
In>0	In+BiasP

- The instruction allows input parameters *BiasN*, *In* and *BiasP* to connect the variables of different data types. When *BiasN*, *In* and *BiasP* are the variables of different data types, the calculation is performed with the data type which can contain the range of the values of *BiasN*, *In* and *BiasP*. For example, if the data type of *BiasN* is INT and the data types of *In* and *BiasP* are DINT, the data type of *Out* is DINT.
- The instruction allows the input parameters and the output parameter to connect the variables of different data types. But the length of the data type of the output variable must contain the length of the variables that the input parameters connect. Otherwise, an error will occur during the compiling of the software.

● Precautions for Correct Use

- The input variables are not allowed to omit. An error will occur during the compiling of the software if the input variables are omitted. But the output variable is allowed to omit.
- When the value of *BiasN* is larger than *BiasP*, the instruction will still be executed normally.



Programming Example

- The data types of ZONE_BiasN, ZONE_In and ZONE_BiasP are INT, INT and DINT and the data type of Out1 is DINT. When ZONE_EN is TRUE, the value of Out1 is 0 if the values of ZONE_BiasN, ZONE_In and ZONE_BiasP are 1, 0 and 100 as shown in the following table Variable 1. If the values of ZONE_BiasN, ZONE_In and ZONE_BiasP are 2, 50 and 100, the value of Out1 is 150 (150 = 50 + 100) as shown in the following table Variable 2. If the values of ZONE_BiasN, ZONE_In and ZONE_BiasP are 50, -10 and 100, the value of Out1 is 40 (40 = - 10 + 50) as shown in the following table Variable 3.

➤ Variable 1

Variable name	Data type	Current value
ZONE_EN	BOOL	TRUE
ZONE_BiasN	INT	1
ZONE_In	INT	0
ZONE_BiasP	DINT	100
Out1	DINT	0

➤ Variable 2

Variable name	Data type	Current value
ZONE_EN	BOOL	TRUE
ZONE_BiasN	INT	2
ZONE_In	INT	50
ZONE_BiasP	DINT	100
Out1	DINT	150

➤ Variable 3

Variable name	Data type	Current value
ZONE_EN	BOOL	TRUE
ZONE_BiasN	INT	50

Variable name	Data type	Current value
ZONE_In	INT	- 10
ZONE_BiasP	DINT	100
Out1	DINT	40

➤ **The program**

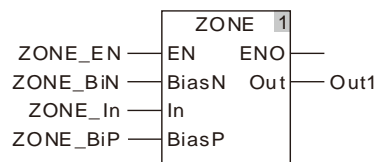

8.13 Data Type Conversion Instructions

8.13.1 BOOL_TO_***

FB/FC	Explanation	Applicable model
FC	BOOL_TO_*** instructions convert boolean data into the data of basic data types. "****" can be any basic data type.	DVP15MC11T DVP15MC11T-06



Parameters

Parameter name	Meaning	Input/ Output	Description	Valid range
In	Data to convert	Input	Data to convert	Depends on the data type of the variable that the input parameter is connected to.
Out	Conversion result	Output	Conversion result	Depends on the data type of the variable that the output parameter is connected to.

	Boolean	Bit string				Integer							Real number		Time, date				String		
	BOOL	BYTE	WORD	DWORD	LWORD	USINT	UINT	UDINT	ULINT	SINT	INT	DINT	LINT	REAL	LREAL	TIME	DATE	TOD	DT	STRING	
In	●																				
Out		The data type of <i>Out</i> must be the same as "****" of the instruction name.																			

Note:

The symbol ● indicates that the parameter is allowed to connect to the variable or constant of the data type.

Function Explanation

■ BOOL to Bit String

➤ Relevant instructions:

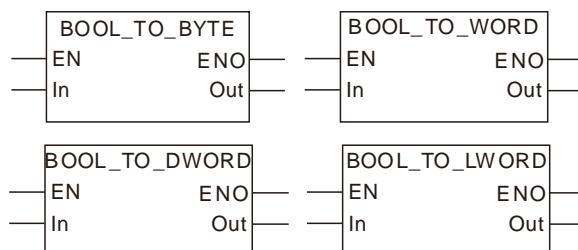

- The rule for the conversion from Boolean to Bit-String is shown in the following table. (The format of the bit-string value and the hexadecimal expression are to be confirmed.)

Boolean	Bit String			
	BYTE	WORD	DWORD	LWORD
FALSE	16#00	16#0000	16#0000_0000	16#0000_0000_0000_0000
TRUE	16#01	16#0001	16#0000_0001	16#0000_0000_0000_0001

■ **BOOL to Integer**

- Relevant instructions:

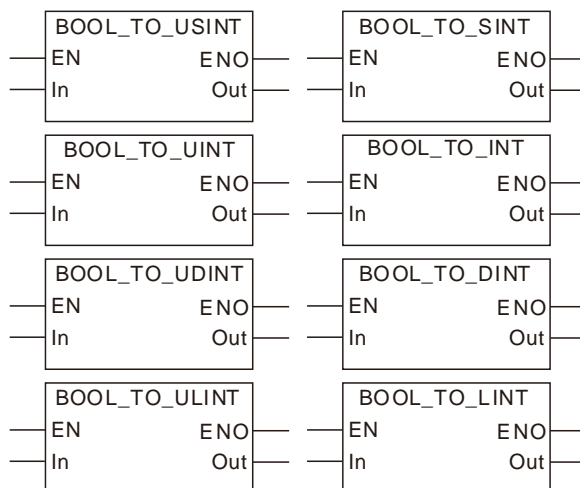

- The rule that Boolean data are converted into Integer data is as the following table shows.

Boolean	Integer							
	USINT	UINT	UDINT	ULINT	SINT	INT	DINT	LINT
FALSE	0	0	0	0	0	0	0	0
TRUE	1	1	1	1	1	1	1	1

■ **BOOL to Real number**

- Relevant instructions:

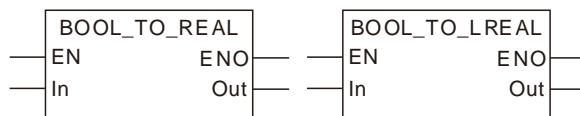

- The rule that Boolean data are converted into Real-number data is as the following table shows.

Boolean	Real	
	REAL	LREAL
FALSE	0	0
TRUE	1	1

■ BOOL to Time and Date

- Relevant instructions:

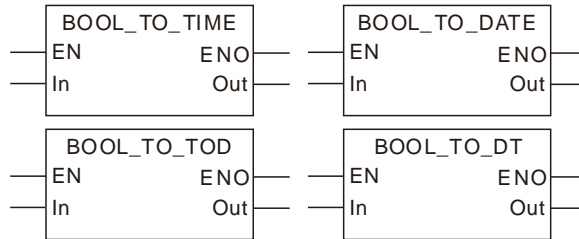

- The rule that Boolean data are converted into Time or Date data is as the following table shows.

Boolean	Time and Date			
	TIME	DATE	TOD	DT
FALSE	T#0ms	D#1970-1-1	TOD#	DT#
TRUE	T#1ms	D#1970-1-1	TOD#	DT#

■ BOOL to String

- Relevant instructions:

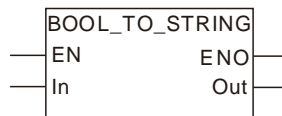

- The rule that Boolean data are converted into String data is as the following table shows. (The string format is to be confirmed.)

Boolean	String
	STRING
FALSE	'FALSE'
TRUE	'TRUE'

● Precautions for Correct Use

The input variables are not allowed to omit. If the input variables are omitted, an error will occur during the compiling of the software. The output variable is allowed to omit.

8.13.2 Bit strings_TO_***

FB/FC	Explanation	Applicable model
FC	Bit strings_TO_*** instructions convert bit-string data into the data of basic data types. "****" can be any basic data type.	DVP15MC11T DVP15MC11T-06



● Parameters

Parameter name	Meaning	Input/ Output	Description	Valid range
In	Data to convert	Input	Data to convert	Depends on the data type of the variable that the input parameter is connected to.
Out	Conversion result	Output	Conversion result	Depends on the data type of the variable that the output parameter is connected to.

	Boolean	Bit string				Integer						Real number		Time, date			String			
	BOOL	BYTE	WORD	DWORD	LWORD	USINT	UINT	UDINT	ULINT	SINT	INT	DINT	LINT	REAL	LREAL	TIME	DATE	TOD	DT	STRING
In		●	●	●	●															
Out	The data type of <i>Out</i> must be the same as "****" of the instruction name.																			

Note:

The symbol ● indicates that the parameter is allowed to connect to the variable or constant of the data type.

● Function Explanation

■ Bit string to BOOL

➤ Relevant instructions:

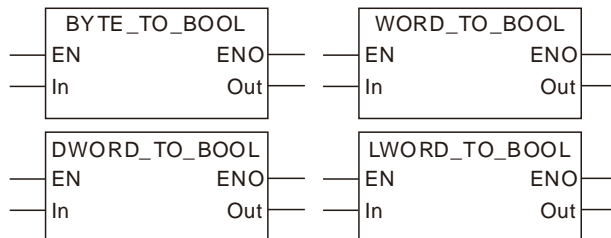

- The rule that Bit-string data are converted into Boolean data is as the following table shows.

Data type		The value of <i>In</i> corresponds to the value of <i>Out</i>	
In	Out	In	Out
BYTE	BOOL	16#00	FALSE
		16#01~16#FF	TRUE
WORD	BOOL	16#0000	FALSE
		16#0001~16#FFFF	TRUE
DWORD	BOOL	16#0000_0000	FALSE
		16#0000_0001~16#FFFF_FFFF	TRUE
LWORD	BOOL	16#0000_0000_0000_0000	FALSE
		16#0000_0000_0000_0001~	TRUE
		16#FFFF_FFFF_FFFF_FFFF	

■ Bit string to Bit string

- Bit-string data can be converted to Bit-string data. And some instructions are shown below.

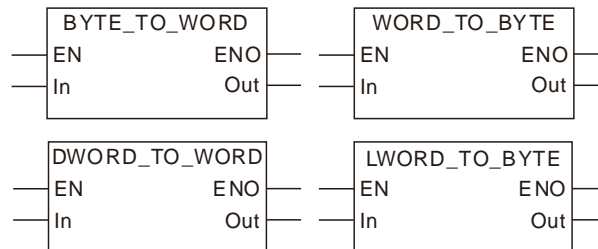

There are two kinds of conversion for different types of bit-string data. One is the conversion of the less-length data to the greater-length data. The other is the conversion of the greater-length data to the less-length data.

The less-length data is converted to the greater-length data by writing the values of all bits of the less-length data to corresponding bits of the greater-length data and setting the values of the remaining bits of the greater-length data to 0.

See the following example that the Byte data in *In* is converted to the Word data in *Out*. The values of Bit0~Bit7 of *In* are copied and pasted to Bit0~Bit7 of *Out*. And the values of Bit8~Bit15 of *Out* are set to 0.

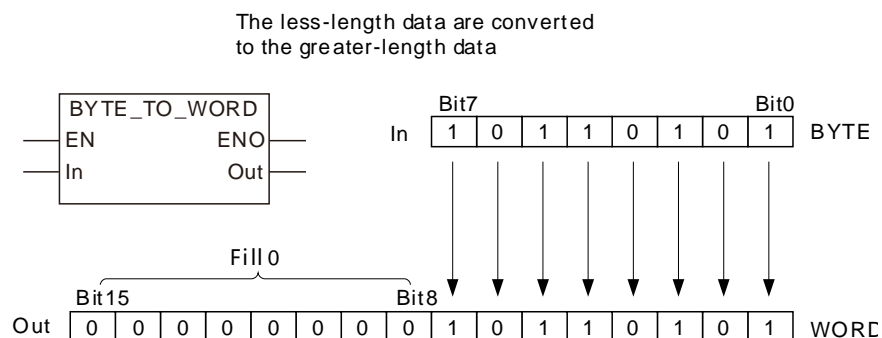

The greater-length data are converted to the less-length data by revising the values of all bits of the less-length data into the values of the corresponding bits of the greater-length data and the values of the remaining bits of the greater-length data are not converted and have no impact on the conversion.

See the following example that the Word data *In* is converted to the Byte data *Out*. The values of Bit0~Bit7 of *In* are copied and pasted to Bit0~Bit7 of *Out*. And the values of Bit8~Bit15 of *In* are not converted and have no impact on the conversion.

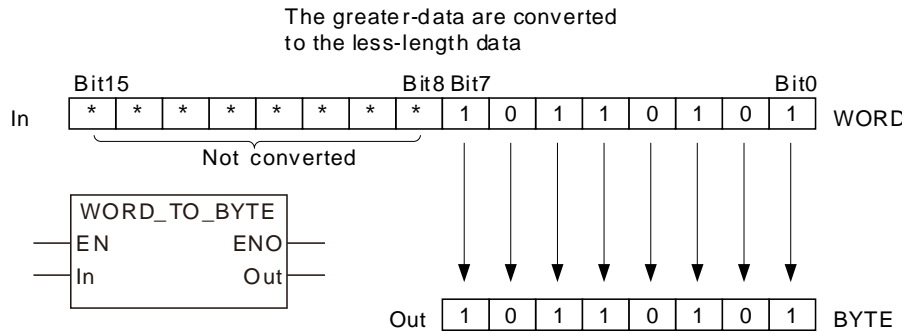

➤ The Bit-string data are converted into the Bit-string data as the following table shows.

Data type		The value of <i>In</i> corresponds to the value of <i>Out</i>	
In	Out	In	Out
BYTE	WORD	16#00~16#FF	16#0000~16#00FF
	DWORD	16#00~16#FF	16#0000_0000~16#0000_00FF
	LWORD	16#00~16#FF	16#0000_0000_0000_0000~16#0000_0000_0000_00FF
WORD	BYTE	16#**00~16#**FF	16#00~16#FF
	DWORD	16#0000~16#FFFF	16#0000_0000~16#0000_FFFF
	LWORD	16#0000~16#FFFF	16#0000_0000_0000_0000~16#0000_0000_0000_FFFF
DWORD	BYTE	16#****_**00~16#****_**FF	16#00~16#FF
	WORD	16#****_0000~16#****_FFFF	16#0000~16#FFFF
	LWORD	16#0000_0000~16#FFFF_FFFF	16#0000_0000_0000_0000~16#0000_0000_FFFF_FFFF
LWORD	BYTE	16#****_****_****_**00~16#****_****_****_**FF	16#00~16#FF
	WORD	16#****_****_****_0000~16#****_****_****_FFFF	16#0000~16#FFFF
	DWORD	16#****_****_0000_0000~16#****_****_FFFF_FFFF	16#0000_0000~16#FFFF_FFFF

■ Bit string to Integer

➤ The Bit-string data can be converted to the Integer data. And some instructions are shown below.

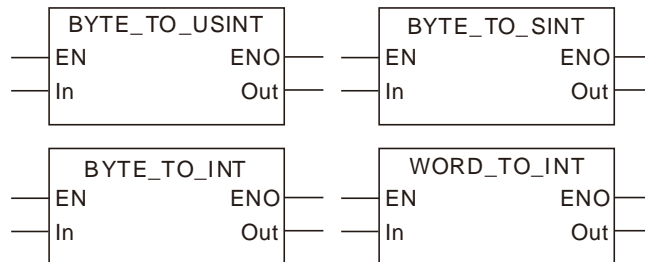

The rule for the conversion of bit-string data into integer data is consistent with that for the conversion of bit-string data into bit-string data.

The less-length data is converted to the greater-length data by writing the values of all bits of

the less-length data to corresponding bits of the greater-length data and setting the values of the remaining bits of the greater-length data to 0.

The greater-length data is converted to the less-length data by revising the values of all bits of the less-length data into the values of the corresponding bits of the greater-length data and the values of the remaining bits of the greater-length data are not converted and have no impact on the conversion.

If the lengths of the two data to convert are equal, all values of all bits of *In* are copied and pasted to the corresponding bits of *Out*.

- The Bit-string data are converted into the Integer data as the following table shows.

Data type		The value of <i>In</i> corresponds to the value of <i>Out</i>	
In	Out	In	Out
BYTE	USINT	16#00~16#FF	0~255
	UINT	16#00~16#FF	0~255
	UDINT	16#00~16#FF	0~255
	ULINT	16#00~16#FF	0~255
	SINT	16#00~16#7F	0~127
		16#80~16#FF	-128~-1
	INT	16#00~16#FF	0~255
	DINT	16#00~16#FF	0~255
LINT	16#00~16#FF	0~255	
WORD	USINT	16#**00~16#**FF	0~255
	UINT	16#0000~16#FFFF	0~65535
	UDINT	16#0000~16#FFFF	0~65535
	ULINT	16#0000~16#FFFF	0~65535
	SINT	16#**00~16#**7F	0~127
		16#**80~16#**FF	-128~-1
	INT	16#0000~16#7FFF	0~32767
		16#8000~16#FFFF	-32768~-1
DINT	16#0000~16#FFFF	0~65535	
LINT	16#0000~16#FFFF	0~65535	
DWORD	USINT	16#****_**00~16#****_**FF	0~255
	UINT	16#****_0000~16#****_FFFF	0~65535
	UDINT	16#0000_0000~16#FFFF_FFF F	0~4294967295
	ULINT	16#0000_0000~16#FFFF_FFF F	0~4294967295
	SINT	16#****_**00~16#****_**7F	0~127
		16#****_**80~16#****_**FF	-128~-1
	INT	16#****_0000~16#****_7FFF	0~32767
		16#****_8000~16#****_FFFF	-32768~-1
DINT	16#0000_0000~16#7FFF_FFF F	0~2147483647	
	16#8000_0000~16#FFFF_FFF F	-2147483648~-1	
LINT	16#0000_0000~16#FFFF_FFF F	0~4294967295	
LWORD	USINT	16#****_****_****_**00~ 16#****_****_****_**FF	0~255
	UINT	16#****_****_****_0000~ 16#****_****_****_FFFF	0~65535

Data type		The value of <i>In</i> corresponds to the value of <i>Out</i>	
In	Out	In	Out
	UDINT	16#****_****_0000_0000~ 16#****_****_FFFF_FFFF	0~4294967295
	ULINT	16#0000_0000_0000_0000~ 16#FFFF_FFFF_FFFF_FFFF	0~18446744073709551645
	SINT	16#****_****_****_**00~ 16#****_****_****_**7F	0~127
		16#****_****_****_**80~ 16#****_****_****_**FF	-128~-1
		16#****_****_****_0000~ 16#****_****_****_7FFF	0~32767
	INT	16#****_****_****_8000~ 16#****_****_****_FFFF	-32768~-1
		16#****_****_0000_0000~ 16#****_****_7FFF_FFFF	0~2147483647
		16#****_****_8000_0000~ 16#****_****_FFFF_FFFF	-2147483648~-1
	LINT	16#0000_0000_0000_0000~ 16#7FFF_FFFF_FFFF_FFFF	0~9223372036854775807
		16#8000_0000_0000_0000~ 16#FFFF_FFFF_FFFF_FFFF	-9223372036854775808~0

■ Bit string to Real number

- The Bit-string data can be converted to the Real-number data. And some instructions are shown below.

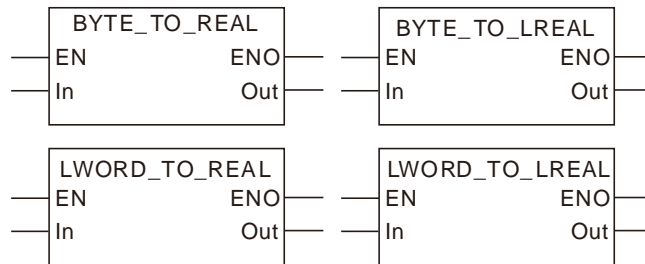

- The Bit-string data are converted into the Real-number data as the following table shows.

Data type		The value of <i>In</i> corresponds to the value of <i>Out</i>	
In	Out	In	Out
BYTE	REAL	16#00~16#FF	0~2.55e+2
	LREAL	16#00~16#FF	0~2.55e+2
WORD	REAL	16#0000~16#FFFF	0~6.5535e+4
	LREAL	16#0000~16#FFFF	0~6.5535e+4
DWORD	REAL	16#0000_0000~ 16#FFFF_FFFF	0~4.294967e+9
	LREAL	16#0000_0000~ 16#FFFF_FFFF	0~4.294967295e+9
LWORD	REAL	16#0000_0000_0000_0000~ 16#FFFF_FFFF_FFFF_FFFF	0~1.844674e+19
	LREAL	16#0000_0000_0000_0000~ 16#FFFF_FFFF_FFFF_FFFF	0~1.84467440737095e+19

■ Bit string to Time and Date

- The Bit-string data can be converted to the Time or Date data. And some instructions are shown below.

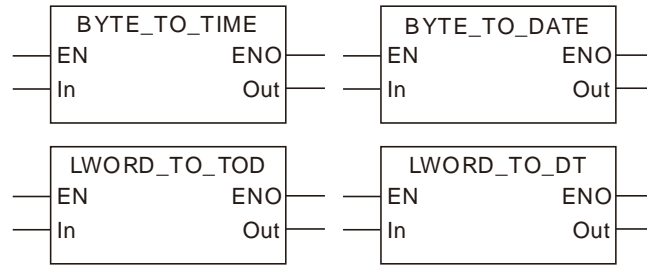

The rule for the conversion of Bit-string data into Time or Date data is the same as that for the conversion of the Bit-string data into unsigned integer data.

- The Bit-string data are converted into the Time and Date data as the following table shows.

Data type		The value of <i>In</i> corresponds to the value of <i>Out</i>	
In	Out	In	Out
BYTE	TIME	16#00~16#FF	T#0ns~T#255ns
	DATE	16#00~16#FF	D#1970-1-1
	TOD	16#00~16#FF	TOD#0:0:0~ TOD#0:0:0.255
	DT	16#00~16#FF	DT#1970-1-1-0:0:0~ DT#1970-1-1-0:4:15
WORD	TIME	16#0000~16#FFFF	T#0ns~T#65us535ns
	DATE	16#0000~16#FFFF	D#1970-1-1
	TOD	16#0000~16#FFFF	TOD#0:0:0~ TOD#0:1:5.535
	DT	16#0000~16#FFFF	DT#1970-1-1-0:0:0~ DT#1970-1-1-18:12:15
DWORD	TIME	16#0000_0000~16#FFFF_FFFF	T#0ns~ T#4s294ms967us295ns
	DATE	16#0000_0000~16#FFFF_FFFF	D#1970-1-1~D#2016-2-7
	TOD	16#0000_0000~16#0526_5BFF	TOD#0:0:0~
		16#0526_5C00~16#0A4C_B7FF	TOD#23:59:59.999
		
DT	16#FC57_9C00~16#FFFF_FFFF	TOD#0:0:0~ TOD#17:2:47.295	
LWORD	TIME	16#0000_0000_0000_0000~ 16# FFFF_FFFF_FFFF_FFFF	T#213503d23h34m33s709ms5 51us615ns
	DATE	16#****_****_0000_0000~ 16#****_****_FFFF_FFFF	D#1970-1-1~D#2016-2-7
	TOD	16#****_****_0000_0000~ 16#****_****_0A4C_B7FF	TOD#0:0:0~
		16#****_****_0526_5C00~ 16#****_****_0A4C_B7FF	TOD#23:59:59.999
		
		16#****_****_0000_0000~ 16#****_****_FFFF_FFFF	TOD#0:0:0~ TOD#17:2:47.295
	DT	16#****_****_0000_0000~ 16#****_****_FFFF_FFFF	DT#1970-1-1-0:0:0~ DT#2016-2-7-6:28:15

■ Bit string to String

- The Bit-string data can be converted to the String data. And some instructions are shown below.

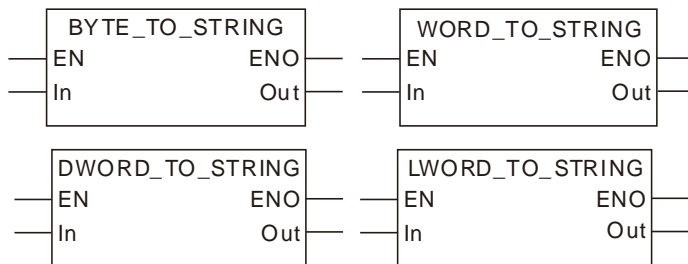

➤ The Bit-string data are converted into the String data as the following table shows.

Data type		The value of <i>In</i> corresponds to the value of <i>Out</i>	
In	Out	In	Out
BYTE	STRING	16#00~16#FF	'00'~'FF'
WORD	STRING	16#0000~16#FFFF	'0000'~'FFFF'
DWORD	STRING	16#0000_0000~16#FFFF_FFFF	'00000000'~'FFFFFFFF'
LWORD	STRING	16#0000_0000_0000_0000~ 16# FFFF_FFFF_FFFF_FFFF	'0000000000000000'~ 'FFFFFFFFFFFFFFFF'

When the Bit-string data are converted to the String data, the length of the output String data must meet the length of the input parameter. For example, during the use of the BYTE_TO_STRING instruction, the output String data must contain more than 2 characters. Otherwise, an error will occur during the compiling of the software.

● **Precautions for Correct Use**

The input variable is not allowed to omit. An error will occur during the compiling of the software if the input variable is omitted. But the output variable is allowed to omit.

8.13.3 Integers_TO_***

FB/FC	Explanation	Applicable model
FC	Integers_TO_*** instructions convert integers into the data of basic data types. "****" can be any basic data type.	DVP15MC11T DVP15MC11T-06

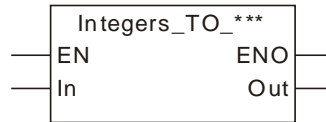

● Parameters

Parameter name	Meaning	Input/ Output	Description	Valid range
In	Data to convert	Input	Data to convert	Depends on the data type of the variable that the input parameter is connected to.
Out	Conversion result	Output	Conversion result	Depends on the data type of the variable that the output parameter is connected to.

	Boolean	Bit string					Integer							Real number		Time, date				String
	BOOL	BYTE	WORD	DWORD	LWORD	USINT	UINT	UDINT	ULINT	SINT	INT	DINT	LINT	REAL	LREAL	TIME	DATE	TOD	DT	STRING
In						●	●	●	●	●	●	●	●							
Out	The data type of <i>Out</i> must be the same as "****" of the instruction name.																			

Note:

The symbol ● indicates that the parameter is allowed to connect to the variable or constant of the data type.

● Function Explanation

■ Integer to BOOL

➤ Some instructions are shown below.

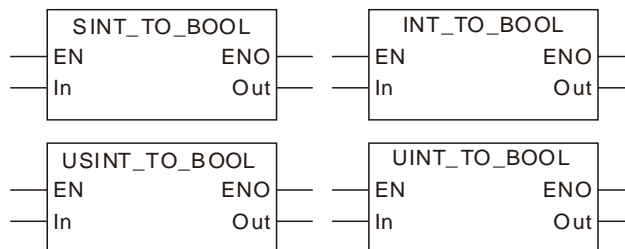

- The Integer data are converted into the Boolean data as the following table shows. If the Integer value is 0, the conversion result is FALSE. If not 0, the result is TRUE. For details on the conversion rule, see the table as follows.

Data type		The value of <i>In</i> corresponds to the value of <i>Out</i>	
In	Out	In	Out
USINT	BOOL	0	FALSE
		1~255	TRUE
UINT	BOOL	0	FALSE
		1~65535	TRUE
UDINT	BOOL	0	FALSE
		1~4294967295	TRUE
ULINT	BOOL	0	FALSE
		1~18446744073709551645	TRUE
SINT	BOOL	0	FALSE
		-128~-1, 1~127	TRUE
INT	BOOL	0	FALSE
		-32768~-1, 1~32767	TRUE
DINT	BOOL	0	FALSE
		-2147483648~-1, 1~2147483647	TRUE
LINT	BOOL	0	FALSE
		-9223372036854775808~-1, 1~9223372036854775807	TRUE

■ Integer to Bit string

- The Integer data can be converted to the Bit-string data. And some instructions are shown below.

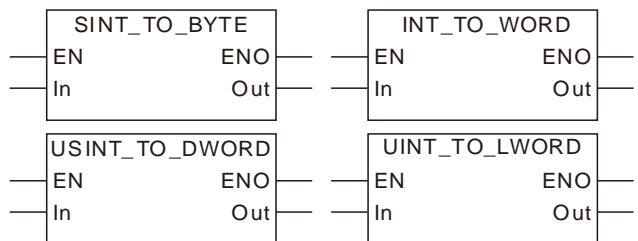

The rule for the conversion of the Integer data into the Bit-string data is the same as that for the conversion of the Bit-string data into the Bit-string data. Refer to section 8.13.2 for details.

- The Integer data are converted into the Bit-string data as the following table shows.

Data type		The value of <i>In</i> corresponds to the value of <i>Out</i>	
In	Out	In	Out
USINT	BYTE	16#00~16#FF	16#00~16#FF
	WORD	16#00~16#FF	16#0000~16#00FF
	DWORD	16#00~16#FF	16#0000_0000~16#0000_00FF
	LWORD	16#00~16#FF	16#0000_0000_0000_0000~16#0000_0000_0000_00FF
UINT	BYTE	16#**00~16#**FF	16#00~16#FF
	WORD	16#0000~16#FFFF	16#0000~16#FFFF
	DWORD	16#0000~16#FFFF	16#0000_0000~16#0000_FFFF
	LWORD	16#0000~16#FFFF	16#0000_0000_0000_0000~16#0000_0000_0000_FFFF
UDINT	BYTE	16#****_**00~16#****_**FF	16#00~16#FF

Data type		The value of <i>In</i> corresponds to the value of <i>Out</i>	
In	Out	In	Out
	WORD	16#****_0000~16#****_FFFF	16#0000~16#FFFF
	DWORD	16#0000_0000~16#FFFF_FFFF	16#0000_0000~16#FFFF_FFFF
	LWORD	16#0000_0000~16#FFFF_FFFF	16#0000_0000_0000_0000~ 16#0000_0000_FFFF_FFFF
ULINT	BYTE	16#****_****_****_**00~ 16#****_****_****_**FF	16#00~16#FF
	WORD	16#****_****_****_0000~ 16#****_****_****_FFFF	16#0000~16#FFFF
	DWORD	16#****_****_0000_0000~ 16#****_****_FFFF_FFFF	16#0000_0000~16#FFFF_FFFF
	LWORD	16#0000_0000_0000_0000~ 16#FFFF_FFFF_FFFF_FFFF	16#0000_0000_0000_0000~ 16#FFFF_FFFF_FFFF_FFFF
SINT	BYTE	16#00~16#FF	16#00~16#FF
	WORD	16#00~16#FF	16#0000~16#00FF
	DWORD	16#00~16#FF	16#0000_0000~16#0000_00FF
	LWORD	16#00~16#FF	16#0000_0000_0000_0000~ 16#0000_0000_0000_00FF
INT	BYTE	16#**00~16#**FF	16#00~16#FF
	WORD	16#0000~16#FFFF	16#0000~16#FFFF
	DWORD	16#0000~16#FFFF	16#0000_0000~16#0000_FFFF
	LWORD	16#0000~16#FFFF	16#0000_0000_0000_0000~ 16#0000_0000_0000_FFFF
DINT	BYTE	16#****_**00~16#****_**FF	16#00~16#FF
	WORD	16#****_0000~16#****_FFFF	16#0000~16#FFFF
	DWORD	16#0000_0000~16#FFFF_FFFF	16#0000_0000~16#FFFF_FFFF
	LWORD	16#0000_0000~16#FFFF_FFFF	16#0000_0000_0000_0000~ 16#0000_0000_FFFF_FFFF
LINT	BYTE	16#****_****_****_**00~ 16#****_****_****_**FF	16#00~16#FF
	WORD	16#****_****_****_0000~ 16#****_****_****_FFFF	16#0000~16#FFFF
	DWORD	16#****_****_0000_0000~ 16#****_****_FFFF_FFFF	16#0000_0000~16#FFFF_FFFF
	LWORD	16#0000_0000_0000_0000~ 16#FFFF_FFFF_FFFF_FFFF	16#0000_0000_0000_0000~ 16#FFFF_FFFF_FFFF_FFFF

■ Integer to Integer

- The Integer data can be converted to the Integer data. And some instructions are shown below.

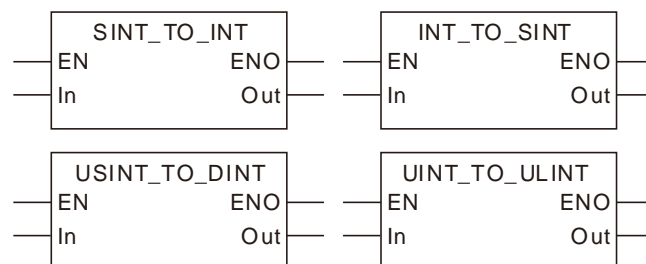

1. The rule for the conversion of the Integer data into the Integer data is the same as that for the conversion of the Bit-string data into the Bit-string data.

2. The less-length data are converted to the greater-length data by writing the values of all bits of the less-length data to corresponding bits of the greater-length data and setting the values of the remaining bits of the greater-length data to 0.
3. The data of greater length is converted to the data of less length by revising the values of all bits of the less-length data into the values of the corresponding bits of the greater-length data and the values of the remaining bits of the greater-length data are not converted and have no impact on the conversion.
4. If the lengths of the two data to convert are equal, all values of all bits of *In* are copied and pasted to the corresponding bits of *Out*.

➤ The Bit-string data are converted into the Integer data as the following table shows.

Data type		The value of <i>In</i> corresponds to the value of <i>Out</i>	
In	Out	In	Out
USINT	USINT	16#00~16#FF	0~255
	UINT	16#00~16#FF	0~255
	UDINT	16#00~16#FF	0~255
	ULINT	16#00~16#FF	0~255
	SINT	16#00~16#7F	0~127
		16#80~16#FF	- 128~ - 1
	INT	16#00~16#FF	0~255
	DINT	16#00~16#FF	0~255
LINT	16#00~16#FF	0~255	
UINT	USINT	16#**00~16#**FF	0~255
	UINT	16#0000~16#FFFF	0~65535
	UDINT	16#0000~16#FFFF	0~65535
	ULINT	16#0000~16#FFFF	0~65535
	SINT	16#**00~16#**7F	0~127
		16#**80~16#**FF	- 128~ -1
	INT	16#0000~16#7FFF 16#8000~16#FFFF	0~32767 - 32768~ -1
	DINT	16#0000~16#FFFF	0~65535
LINT	16#0000~16#FFFF	0~65535	
UDINT	USINT	16#****_**00~16#****_**FF	0~255
	UINT	16#****_0000~16#****_FFFF	0~65535
	UDINT	16#0000_0000~16#FFFF_FFFF	0~4294967295
	ULINT	16#0000_0000~16#FFFF_FFFF	0~4294967295
	SINT	16#****_**00~16#****_**7F	0~127
		16#****_**80~16#****_**FF	-128~-1
	INT	16#****_0000~16#****_7FFF	0~32767
		16#****_8000~16#****_FFFF	-32768~-1
DINT	16#0000_0000~16#7FFF_FFFF	0~2147483647	
	16#8000_0000~16#FFFF_FFFF	-2147483648~-1	
LINT	16#0000_0000~16#FFFF_FFFF	0~4294967295	
ULINT	USINT	16#****_****_****_**00~ 16#****_****_****_**FF	0~255
	UINT	16#****_****_****_0000~ 16#****_****_****_FFFF	0~65535
	UDINT	16#****_****_0000_0000~ 16#****_****_FFFF_FFFF	0~4294967295
	ULINT	16#0000_0000_0000_0000~	0~18446744073709551645

Data type		The value of <i>In</i> corresponds to the value of <i>Out</i>		
In	Out	In	Out	
		16# FFFF_FFFF_FFFF_FFFF		
	SINT	16#****_****_****_**00~ 16#****_****_****_**7F	0~127	
		16#****_****_****_**80~ 16#****_****_****_**FF	-128~-1	
		INT	16#****_****_****_0000~ 16#****_****_****_7FFF	0~32767
			16#****_****_****_8000~ 16#****_****_****_FFFF	-32768~-1
	DINT		16#****_****_0000_0000~ 16#****_****_7FFF_FFFF	0~2147483647
			16#****_****_8000_0000~ 16#****_****_FFFF_FFFF	-2147483648~-1
		LINT	16#0000_0000_0000_0000~ 16#7FFF_FFFF_FFFF_FFFF	0~9223372036854775807
			16#8000_0000_0000_0000~ 16#FFFF_FFFF_FFFF_FFFF	-9223372036854775808~0
SINT	USINT		16#00~16#FF	0~255
	UINT		16#00~16#FF	0~255
	UDINT	16#00~16#FF	0~255	
	ULINT	16#00~16#FF	0~255	
	SINT	16#00~16#7F	0~127	
		16#80~16#FF	-128~-1	
	INT	16#00~16#FF	0~255	
	DINT	16#00~16#FF	0~255	
LINT	16#00~16#FF	0~255		
INT	USINT	16#**00~16#**FF	0~255	
	UINT	16#0000~16#FFFF	0~65535	
	UDINT	16#0000~16#FFFF	0~65535	
	ULINT	16#0000~16#FFFF	0~65535	
	SINT	16#**00~16#**7F	0~127	
		16#**80~16#**FF	-128~-1	
	INT	16#0000~16#7FFF	0~32767	
		16#8000~16#FFFF	-32768~-1	
DINT	16#0000~16#FFFF	0~65535		
LINT	16#0000~16#FFFF	0~65535		
DINT	USINT	16#****_**00~16#****_**FF	0~255	
	UINT	16#****_0000~16#****_FFFF	0~65535	
	UDINT	16#0000_0000~16#FFFF_FFFF	0~4294967295	
	ULINT	16#0000_0000~16#FFFF_FFFF	0~4294967295	
DINT	SINT	16#****_**00~16#****_**7F	0~127	
		16#****_**80~16#****_**FF	-128~-1	
	INT	16#****_0000~16#****_7FFF	0~32767	
		16#****_8000~16#****_FFFF	-32768~-1	
	DINT	16#0000_0000~16#7FFF_FFFF	0~2147483647	
		16#8000_0000~16#FFFF_FFFF	-2147483648~-1	
LINT	16#0000_0000~16#FFFF_FFFF	0~4294967295		

Data type		The value of <i>In</i> corresponds to the value of <i>Out</i>	
In	Out	In	Out
LINT	USINT	16#****_****_****_**00~	0~255
		16#****_****_****_**FF	
	UINT	16#****_****_****_0000~	0~65535
		16#****_****_****_FFFF	
	UDINT	16#****_****_0000_0000~	0~4294967295
		16#****_****_FFFF_FFFF	
	ULINT	16#0000_0000_0000_0000~	0~18446744073709551645
		16#FFFF_FFFF_FFFF_FFFF	
	SINT	0~127	16#****_****_****_**00~
			16#****_****_****_**7F
		-128~-1	16#****_****_****_**80~ 16#****_****_****_**FF
	INT	0~32767	16#****_****_****_0000~
16#****_****_****_7FFF			
-32768~-1		16#****_****_****_8000~ 16#****_****_****_FFFF	
DINT	0~2147483647	16#****_****_0000_0000~	
		16#****_****_7FFF_FFFF	
	-2147483648~-1	16#****_****_8000_0000~ 16#****_****_FFFF_FFFF	
LINT	0~9223372036854775807	16#0000_0000_0000_0000~	
		16#7FFF_FFFF_FFFF_FFFF	
	-9223372036854775808~0	16#8000_0000_0000_0000~ 16#FFFF_FFFF_FFFF_FFFF	

■ Integer to Real number

- The Integer data can be converted to the Real-number data. And some instructions are shown below.

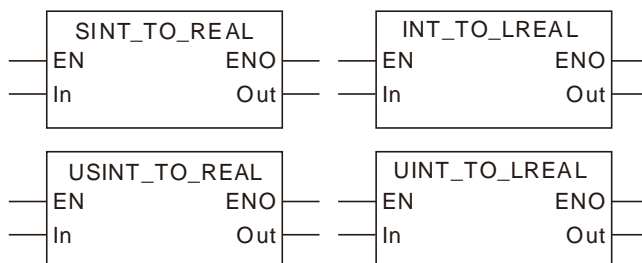

- The Integer data are converted into the Real-number data as the following table shows.

Data type		The value of <i>In</i> corresponds to the value of <i>Out</i>	
In	Out	In	Out
USINT	REAL	0~255	0~2.55e+2
	LREAL	0~255	0~2.55e+2
UINT	REAL	0~65535	0~6.5535e+4
	LREAL	0~65535	0~6.5535e+4
UDINT	REAL	0~4294967295	0~4.294967e+9
	LREAL	0~4294967295	0~4.294967295e+9
ULINT	REAL	0~18446744073709551615	0~1.844674e+19
	LREAL	0~18446744073709551615	0~1.84467440737095e+19
SINT	REAL	-128~127	-1.28e+2~1.27e+2
	LREAL	-128~127	-1.28e+2~1.27e+2
INT	REAL	-32768~32767	-3.2768e+4~3.2767e+4
	LREAL	-32768~32767	-3.2768e+4~3.2767e+4
DINT	REAL	-2147483648~2147483647	-2.147483e+9~2.147483e+9
	LREAL	-2147483648~2147483647	-2.147483e+9~2.147483e+9
LINT	REAL	-9223372036854775808~ 9223372036854775807	-9.223372e+18~9.223372e+18
	LREAL	-9223372036854775808~ 9223372036854775807	-9.22337203685477e+18~ 9.22337203685477e+18

■ Integer to Time or Date

- The Integer data are converted into the Time or Date data and some instructions are shown as below.

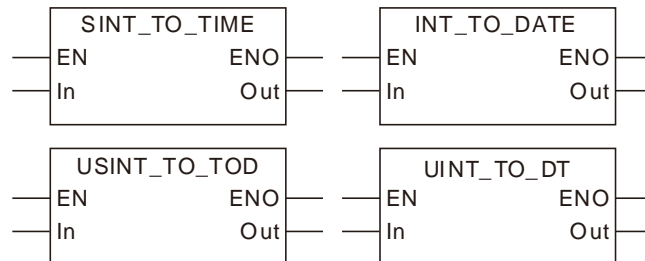

The rule for the conversion of the Integer data into the Time or Date data is the same as that for the conversion of the Integer data into the unsigned integer data.

- The Integer data are converted into the Time or Date data as the following table shows.

Data type		The value of <i>In</i> corresponds to the value of <i>Out</i>	
In	Out	In	Out
USINT	TIME	16#00~16#FF	T#0ns~T#255ns
	DATE	16#00~16#FF	D#1970-1-1
	TOD	16#00~16#FF	TOD#0:0:0~ TOD#0:0:0.255
	DT	16#00~16#FF	DT#1970-1-1-0:0:0~ DT#1970-1-1-0:4:15
UINT	TIME	16#0000~16#FFFF	T#0ns~T#65us535ns
	DATE	16#0000~16#FFFF	D#1970-1-1
	TOD	16#0000~16#FFFF	TOD#0:0:0~ TOD#0:1:5.535
	DT	16#0000~16#FFFF	DT#1970-1-1-0:0:0~ DT#1970-1-1-18:12:15
UDINT	TIME	16#00000000~16#FFFFFFFF	T#0ns~

Data type		The value of <i>In</i> corresponds to the value of <i>Out</i>	
In	Out	In	Out
			T#4s294ms967us295ns
	DATE	16#00000000~16#FFFFFFFF	D#1970-1-1~D#2016-2-7
	TOD	16#00000000~16#05265BFF	TOD#0:0:0~ TOD#23:59:59.999
		16#05265C00~16#0A4CB7FF	
		
		16#FC579C00~16#FFFFFFFF	TOD#0:0:0~ TOD#17:2:47.295
	DT	16#00000000~16#FFFFFFFF	DT#1970-1-1-0:0:0~ DT#2016-2-7-6:28:15
ULINT	TIME	16#0000000000000000~16#FFFFFFFFFFFFFFFF	T#213503d23h34m33s709ms551us615ns
	DATE	16#*****00000000~16#*****FFFFFFFF	D#1970-1-1~D#2016-2-7
	TOD	16#*****00000000~16#*****0A4CB7FF	TOD#0:0:0~ TOD#23:59:59.999
		16#*****05265C00~16#*****0A4CB7FF	
		
	16#*****00000000~16#*****FFFFFFFF	TOD#0:0:0~ TOD#17:2:47.295	
DT	16#*****00000000~16#*****FFFFFFFF	DT#1970-1-1-0:0:0~ DT#2016-2-7-6:28:15	
SINT	TIME	16#00~16#FF	T#0ns~T#255ns
	DATE	16#00~16#FF	D#1970-1-1
	TOD	16#00~16#FF	TOD#0:0:0~ TOD#0:0:0.255
	DT	16#00~16#FF	DT#1970-1-1-0:0:0~ DT#1970-1-1-0:4:15
INT	TIME	16#0000~16#FFFF	T#0ns~T#65us535ns
	DATE	16#0000~16#FFFF	D#1970-1-1
	TOD	16#0000~16#FFFF	TOD#0:0:0~ TOD#0:1:5.535
	DT	16#0000~16#FFFF	DT#1970-1-1-0:0:0~ DT#1970-1-1-18:12:15
DINT	TIME	16#00000000~16#FFFFFFFF	T#0ns~T#4s294ms967us295ns
	DATE	16#00000000~16#FFFFFFFF	D#1970-1-1~D#2016-2-7
	TOD	16#00000000~16#05265BFF	TOD#0:0:0~ TOD#23:59:59.999
		16#05265C00~16#0A4CB7FF	
		
	16#FC579C00~16#FFFFFFFF	TOD#0:0:0~ TOD#17:2:47.295	
DT	16#00000000~16#FFFFFFFF	DT#1970-1-1-0:0:0~ DT#2016-2-7-6:28:15	
LINT	TIME	16#0000000000000000~16#FFFFFFFFFFFFFFFF	T#213503d23h34m33s709ms551us615ns
	DATE	16#*****00000000~16#*****FFFFFFFF	D#1970-1-1~D#2016-2-7
	TOD	16#*****00000000~16#*****0A4CB7FF	TOD#0:0:0~ TOD#23:59:59.999
		16#*****05265C00~16#*****0A4CB7FF	
		
	16#*****00000000~16#*****FFFFFFFF	TOD#0:0:0~ TOD#17:2:47.295	

Data type		The value of <i>In</i> corresponds to the value of <i>Out</i>	
In	Out	In	Out
	DT	16#*****0000000~ 16#*****FFFFFFFF	DT#1970-1-1-0:0:0~ DT#2016- 2-7-6:28:15

■ Integer to String

- The Integer data can be converted to the String data and some instructions are shown as below.

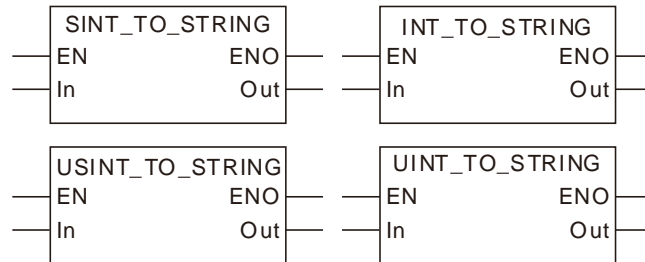

- The Integer data are converted into the String data as the following table shows.

Data type		The value of <i>In</i> corresponds to the value of <i>Out</i>	
In	Out	In	Out
USINT	STRING	0~255	'0'~'255'
UINT	STRING	0~65535	'0'~'65535'
UDINT	STRING	0~4294967295	'0'~'4294967295'
ULINT	STRING	0~18446744073709551615	'0'~'18446744073709551615'
SINT	STRING	-128~127	'-128'~'127'
INT	STRING	-32768~32767	'-32768'~'32767'
DINT	STRING	-2147483648~2147483647	'-2147483648'~'2147483647'
LINT	STRING	-9223372036854775808~ 9223372036854775807	'-9223372036854775808'~ '9223372036854775807'

When the Bit-string data are converted to the String data, the length of the output String data must meet the length of the input parameter.

● Precautions for Correct Use

The input variable is not allowed to omit. An error will occur during the compiling of the software if the input variable is omitted. But the output variable is allowed to omit.

8.13.4 Real numbers_TO_***

FB/FC	Explanation	Applicable model
FC	Real numbers_TO_*** instructions convert real numbers into the data of basic data types. "****" can be any basic data type.	DVP15MC11T DVP15MC11T-06

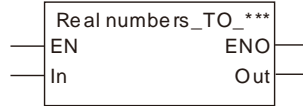

● Parameters

Parameter name	Meaning	Input/Output	Description	Valid range
In	Data to convert	Input	Data to convert	Depends on the data type of the variable that the input parameter is connected to.
Out	Conversion result	Output	Conversion result	Depends on the data type of the variable that the output parameter is connected to.

	Boolean	Bit string				Integer						Real number		Time, date				String		
	BOOL	BYTE	WORD	DWORD	LWORD	USINT	UINT	UDINT	ULINT	SINT	INT	DINT	LINT	REAL	LREAL	TIME	DATE	TOD	DT	STRING
In														●	●					
Out	The data type of <i>Out</i> must be the same as "****" of the instruction name.																			

Note:

The symbol ● indicates that the parameter is allowed to connect to the variable or constant of the data type.

● Function Explanation

■ Real Number to BOOL

- Relevant instructions:

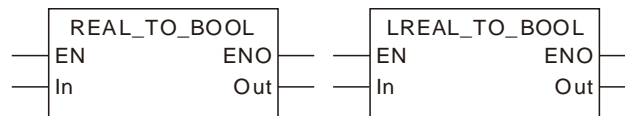

- The real numbers are converted into the Boolean data as the following table shows. If the real number is 0, the conversion result is FALSE. If the real number is not 0, the conversion result is TRUE. For details on the rule, see the table as follows.

Data type		The value of <i>In</i> corresponds to the value of <i>Out</i>	
In	Out	In	Out
REAL	BOOL	-3.402823E+38~-1.175495E-38	TRUE
		0	FALSE
		1.175495E-38~3.402823E+38	TRUE
LREAL	BOOL	-1.79769313486231E+308~-2.22507385850721E-308	TRUE
		0	FALSE
		2.22507385850721E-308~1.79769313486231E+308	TRUE

■ Real Number to Integer

- Real numbers can be converted to integers. And some instructions are shown below.

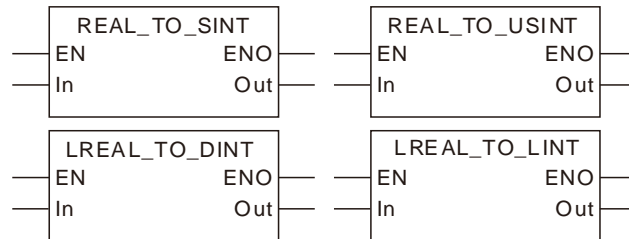

- For the real number-to-integer conversion, there are two cases in which the fractional part is truncated and rounded up as follows.

Case 1: If the first digital number of the fractional part is less than 5, the fractional part will be truncated and the integer part will not change.

Case 2: If the first digital number of the fractional part is greater than or equal to 5, the fractional part will be truncated and the integer part will add by 1.

Input value		Output result	
		Data type	Output value
Case 1	1.36	SINT	1
		USINT	1
	-2.4	SINT	-2
		USINT	254
Case 2	1.6	SINT	2
		USINT	2
	-2.6	SINT	-3
		USINT	253

Note:

For the Real Number-to-Integer Conversion, there are two cases for the value of a real number.

1. If the number of input digits of a real number exceeds what is allowed, the result will be an unsure value. Please set a limit in the user program in order to get a correct value. For example: Then the input value is 123456789 and the number of its digits exceeds the set limit 7. The digits which go beyond the limit are abnormal. Then the output value is 123456792.
2. If the number of input digits does not exceed the set limit, the result is calculated based on the conversion rule.

■ Real Number to Bit string

- Real numbers can be converted to bit strings. And some instructions are shown below.

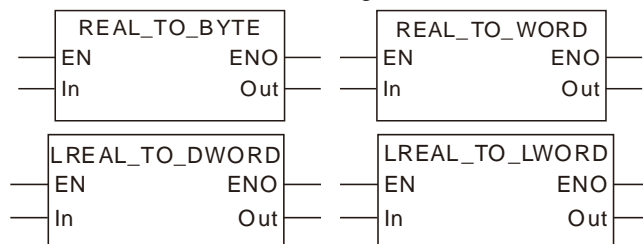

The rule for the conversion of real numbers into bit strings is the same as that for the conversion of real numbers into unsigned integers.

■ **Real Number to Real Number**

➤ Real numbers can be converted to real numbers. And some instructions are shown below.

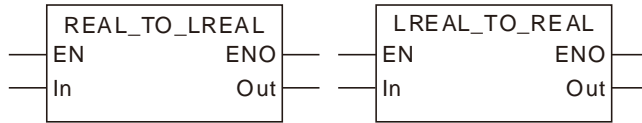

■ **Real Number to Time or Date**

➤ Real numbers can be converted to times or dates. And some instructions are shown below.

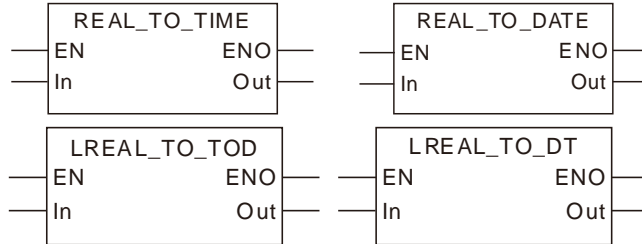

For the real number-to-time or date conversion, the real number is converted to the integer first and then the integer is converted to the time or date. For relevant contents, refer to the real number-to-integer conversion and integer-to-time or date conversion.

■ **Real Number to String**

➤ Real numbers can be converted to strings. And some instructions are shown below.

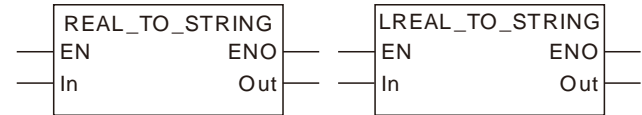

The rule for the real number-to-string conversion is the same as that for the integer-to-string conversion. Refer to section 8.13.3 for details.

● **Precautions for Correct Use**

The input variable is not allowed to omit. An error will occur during the compiling of the software if the input variable is omitted. But the output variable is allowed to omit.

8.13.5 Times, dates_TO_***

FB/FC	Explanation	Applicable model
FC	Times, dates_TO_*** instructions convert Time or date data into the data of basic data types. "****" can be any basic data type.	DVP15MC11T DVP15MC11T-06

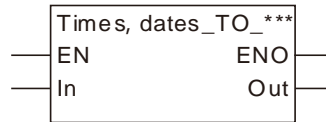

Parameters

Parameter name	Meaning	Input/ Output	Description	Valid range
In	Data to convert	Input	Data to convert	Depends on the data type of the variable that the input parameter is connected to.
Out	Conversion result	Output	Conversion result	Depends on the data type of the variable that the output parameter is connected to.

	Boolean	Bit string					Integer							Real number		Time, date				String
	BOOL	BYTE	WORD	DWORD	LWORD	USINT	UINT	UDINT	ULINT	SINT	INT	DINT	LINT	REAL	LREAL	TIME	DATE	TOD	DT	STRING
In																●	●	●	●	
Out	The data type of <i>Out</i> must be the same as "****" of the instruction name.																			

Note:

The symbol ● indicates that the parameter is allowed to connect to the variable or constant of the data type.

Function Explanation

Time and Date to Bool, Bit String, Integer, Real Number and String

The rule for the conversion of the time and date into the bool, bit string, integer, real number and string is the same as that for the conversion of the unsigned integer into bool, bit string, integer, real number and string. Refer to section 8.13.5 for details.

Time and Date to Time and Date

- The time and date data can be converted to each other. And some instructions are shown below.

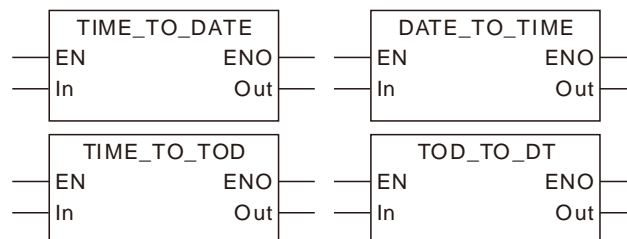

The rule for the conversion of the time and date data into the time and date data is the same as that for the conversion of unsigned integers into unsigned integers. The units must be uniform during the conversion. The unit of TIME is ns (nanosecond) and the unit of others is

ms (millisecond).

- **Precautions for Correct Use**

The input variable is not allowed to omit. An error will occur during the compiling of the software if the input variable is omitted. But the output variable is allowed to omit.

8.13.6 Strings_TO_***

FB/FC	Explanation	Applicable model
FC	Strings_TO_*** instructions convert String data into the data of basic data types. "****" can be any basic data type.	DVP15MC11T DVP15MC11T-06

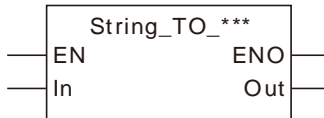

● Parameters

Parameter name	Meaning	Input/ Output	Description	Valid range
In	Data to convert	Input	Data to convert	Depends on the data type of the variable that the input parameter is connected to.
Out	Conversion result	Output	Conversion result	Depends on the data type of the variable that the output parameter is connected to.

	Boolean	Bit string					Integer							Real number		Time, date				String
	BOOL	BYTE	WORD	DWORD	LWORD	USINT	UINT	UDINT	ULINT	SINT	INT	DINT	LINT	REAL	LREAL	TIME	DATE	TOD	DT	STRING
In																				●
Out	The data type of <i>Out</i> must be the same as "****" of the instruction name.																			

Note:

The symbol ● indicates that the parameter is allowed to connect to the variable or constant of the data type.

● Function Explanation

■ String to Bool

- Relevant instructions:



The rule for the String-to-Bool conversion is that the output Bool value is TRUE only when the string value is TRUE or true. Otherwise, the output is FALSE.

■ String to Integer

- Strings can be converted to integers. And some instructions are shown below.

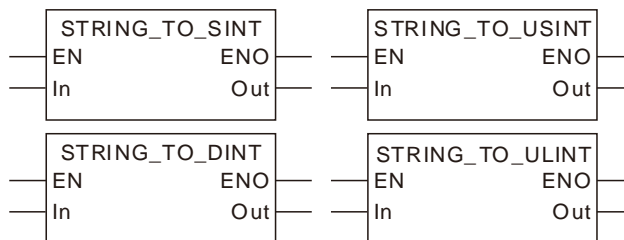

- For the string-to-integer conversion, the string is required to be the integer value such as '123', '-123' and '+123'. The string like 'M123' is not allowed to convert to the integer. The conversion examples are shown in the following table.

Input value	Output result	
	Data type	Output value
'123'	SINT	123
'+123'	SINT	123
'-123'	SINT	-123
'M123'	SINT	The conversion is not allowed and the original value of the output variable is retained.

■ **String to Real Number**

- Strings can be converted to real numbers. And some instructions are shown below.

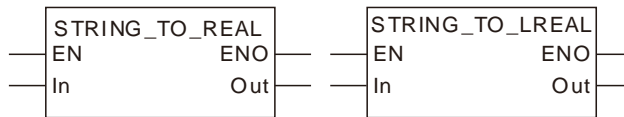

- For the string-to-real number conversion, the string is required to be the real number value such as '123', '-123.123' and '1.23e+5'. The conversion examples are shown in the following table.

Input value	Output result	
	Data type	Output value
'123'	REAL	123
'-123.123'	REAL	-123.123
'1.23e+5'	REAL	-1.23e+5
'M123.123'	REAL	The conversion is not allowed and the original value of the output variable is retained.

■ **String to Time or Date**

- Strings can be converted to times and dates. And some instructions are shown below.

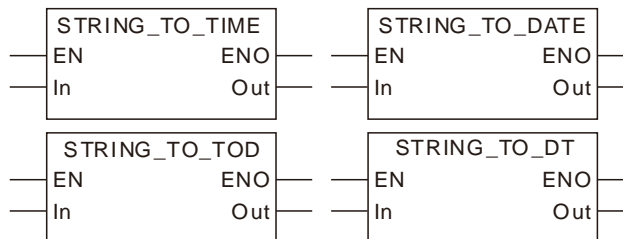

- For the string-to-time or date conversion, the string is required to represent the time or date value such as 'T#1ns', 'D#1970-1-1', 'TOD#0:0:0' and 'DT#1970-1-1-0:0:0'. The conversion examples are shown in the following table.

Input value	Output result	
	Data type	Output value
'T#1ns'	TIME	T#1ns
'D#1970-1-1'	DATE	D#1970-1-1
'TOD#0:0:0'	TOD	TOD#0:0:0
'DT#1970-1-1-0:0:0'	DT	DT#1970-1-1-0:0:0

■ **String to Bit String**

- Strings can be converted to bit strings. And some instructions are shown below.

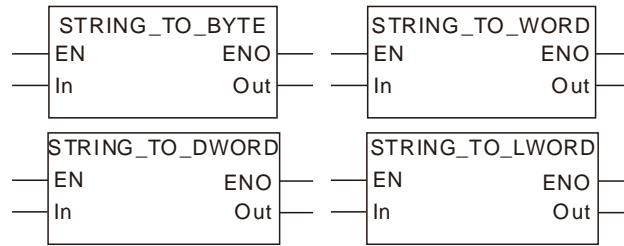

The rule for the string-to-bit string conversion is the same as that for the string-to integer conversion.

● **Precautions for Correct Use**

The input variable is not allowed to omit. An error will occur during the compiling of the software if the input variable is omitted. But the output variable is allowed to omit.

8.14 Communication Instructions

8.14.1 CANopen Communication Instructions

8.14.1.1 DMC_ReadParameter_CANopen

FB/FC	Explanation	Applicable model
FB	DMC_ReadParameter_CANopen is used to read a parameter value of a slave.	DVP15MC11T DVP15MC11T-06

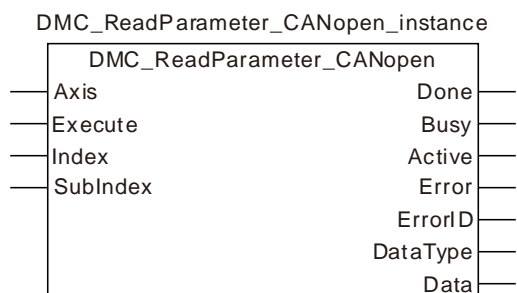

● Input Parameters

Parameter name	Function	Data type	Valid range (Default)	Validation timing
Axis	Specify the slave which is to be controlled by the instruction	USINT	1~127 (The variable value must be set)	When <i>Execute</i> changes from FALSE to TRUE
Execute	The instruction is executed when <i>Execute</i> changes from FALSE to TRUE.	BOOL	TRUE or FALSE (FALSE)	
Index	The index of a parameter to be read	UINT	0	When <i>Execute</i> changes from FALSE to TRUE
SubIndex	The subindex of a parameter to be read	USINT	0	When <i>Execute</i> changes from FALSE to TRUE

● Output Parameters

Parameter name	Function	Data type	Valid range
Done	TRUE when the instruction execution is completed.	BOOL	TRUE / FALSE
Busy	TRUE when the instruction is being executed.	BOOL	TRUE / FALSE
Active	TRUE when the axis is being controlled.	BOOL	TRUE / FALSE
Error	TRUE when there is an error.	BOOL	TRUE / FALSE
ErrorID	Contains error codes when an error occurs. Please refer to section 12.2 for the corresponding error code.	WORD	
Data Type	The data type of the read parameter. 1: Byte, 2: Word, 4: Double Word	USINT	
Data	The value of the parameter which has been read	UDINT	

■ **The index and subindex of the slave parameter to be read:**

1. The user-defined parameter is a servo drive parameter to be read. The data length is specified by users according to the data type of the read parameter. The data length of the byte parameter is 1, the data length of the word parameter is 2 and the data length of the double-word parameter is 4.

The method of calculating the index and subindex of a servo drive parameter:

Index= a servo drive parameter value (Hex) + 2000 (Hex)

Subindex= 0.

Example:

The index and subindex of the servo drive parameter P6-10 are [2000 + 060A (the hexadecimal value of P6-10)] 260A and 0 respectively.

➤ **The variable table and program**

Variable name	Data type	Initial value
ReadPm_C	DMC_ReadParameter_CANopen	
ReadPm_C_Ex	BOOL	FALSE
ReadPm_C_Done	BOOL	
ReadPm_C_Bsy	BOOL	
ReadPm_C_Act	BOOL	
ReadPm_C_Err	BOOL	
ReadPm_C_ErrID	WORD	
ReadPm_C_DaTy	USINT	
ReadPm_C_Dat	UDINT	

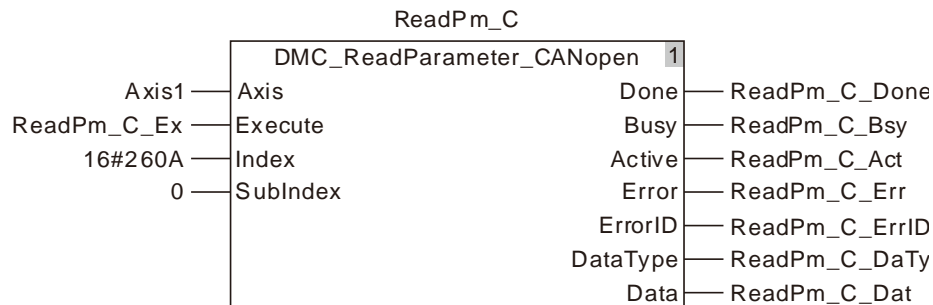

2. For the index and subindex of other slave parameters, refer to CANopen-related manual of the slave.

● **Output Update Timing**

Parameter Name	Timing for changing to TRUE	Timing for changing to FALSE
Done	◆ When the reading of the parameter content is completed.	◆ When <i>Execute</i> changes from TRUE to FALSE after the instruction execution is completed.
Busy	◆ When <i>Execute</i> changes to TRUE	◆ When <i>Error</i> changes to TRUE ◆ When <i>Done</i> changes from FALSE to TRUE
Active	◆ When the slave starts being controlled by the instruction	◆ When <i>Error</i> changes to TRUE ◆ When <i>Done</i> changes from FALSE to TRUE

Parameter Name	Timing for changing to TRUE	Timing for changing to FALSE
Error	◆ When an error occurs in the instruction execution or the input parameters for the instruction are illegal.	◆ When <i>Execute</i> changes from TRUE to FALSE

● **Output Timing Chart**

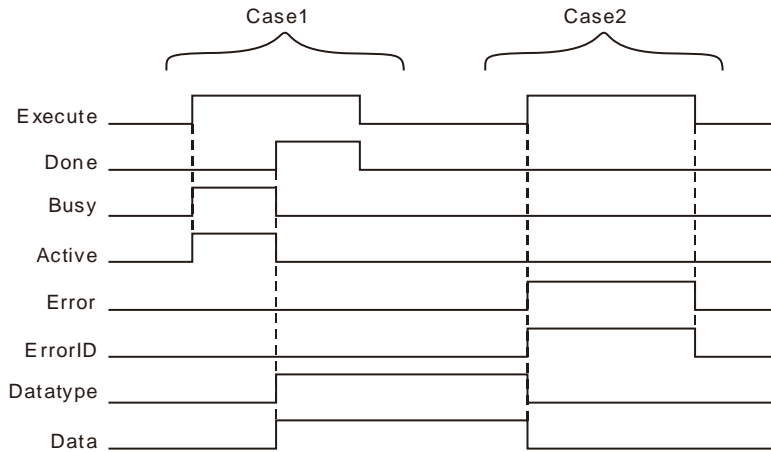

Case 1 : *Busy* and *Active* change to TRUE when *Execute* changes from FALSE to TRUE and one period later, *Done* changes to TRUE and *Datatype* and *Data* show corresponding data. When *Done* changes to TRUE, *Busy* and *Active* change to FALSE. When *Execute* changes from TRUE to FALSE, *Done* changes from TRUE to FALSE and *Datatype* and *Data* retain original values.

Case 2 : Before *DMC_ReadParameter_CANOpen* is executed, the input parameter value such as axis No: 0 is illegal. When *Execute* changes from FALSE to TRUE, *Error* changes from FALSE to TRUE, the values of *Datatype* and *Data* are cleared to 0 and *ErrorID* shows corresponding error codes. As *Execute* changes from TRUE to FALSE, *Error* changes from TRUE to FALSE and the content of *ErrorID* is cleared to 0.

● **Functions**

DMC_ReadParameter_CANOpen is used to read the parameter value of a slave. Users can specify the index and subindex of the parameter to be read.



Programming Example

Below is an example of *DMC_ReadParameter_CANOpen* instruction execution.

■ **The variable table and program**

Variable name	Data type	Current value
ReadPm_C1	DMC_ReadParameter_CANOpen	
Axis1	USINT	1
ReadPm_C1_Ex	BOOL	TRUE
ReadPm_C1_Done	BOOL	TRUE
ReadPm_C1_Bsy	BOOL	FALSE
ReadPm_C1_Act	BOOL	FALSE
ReadPm_C1_Err	BOOL	FALSE
ReadPm_C1_ErrID	WORD	FALSE
ReadPm_C1_DaTy	USINT	2
ReadPm_C1_Dat	UDINT	5000
WritePm_C	DMC_WriteParameter_CANOpen	
WritePm_C_Done	BOOL	TRUE
WritePm_C_Bsy	BOOL	FALSE

Variable name	Data type	Current value
WritePm_C_Act	BOOL	FALSE
WritePm_C_Err	BOOL	FALSE
WritePm_C_ErrID	WORD	FALSE
ReadPm_C2	DMC_ReadParameter_CANopen	
ReadPm_C2_Done	BOOL	TRUE
ReadPm_C2_Bsy	BOOL	FALSE
ReadPm_C2_Act	BOOL	FALSE
ReadPm_C2_Err	BOOL	FALSE
ReadPm_C2_ErrID	WORD	FALSE
ReadPm_C2_DaTy	USINT	2
ReadPm_C2_Dat	UDINT	1000

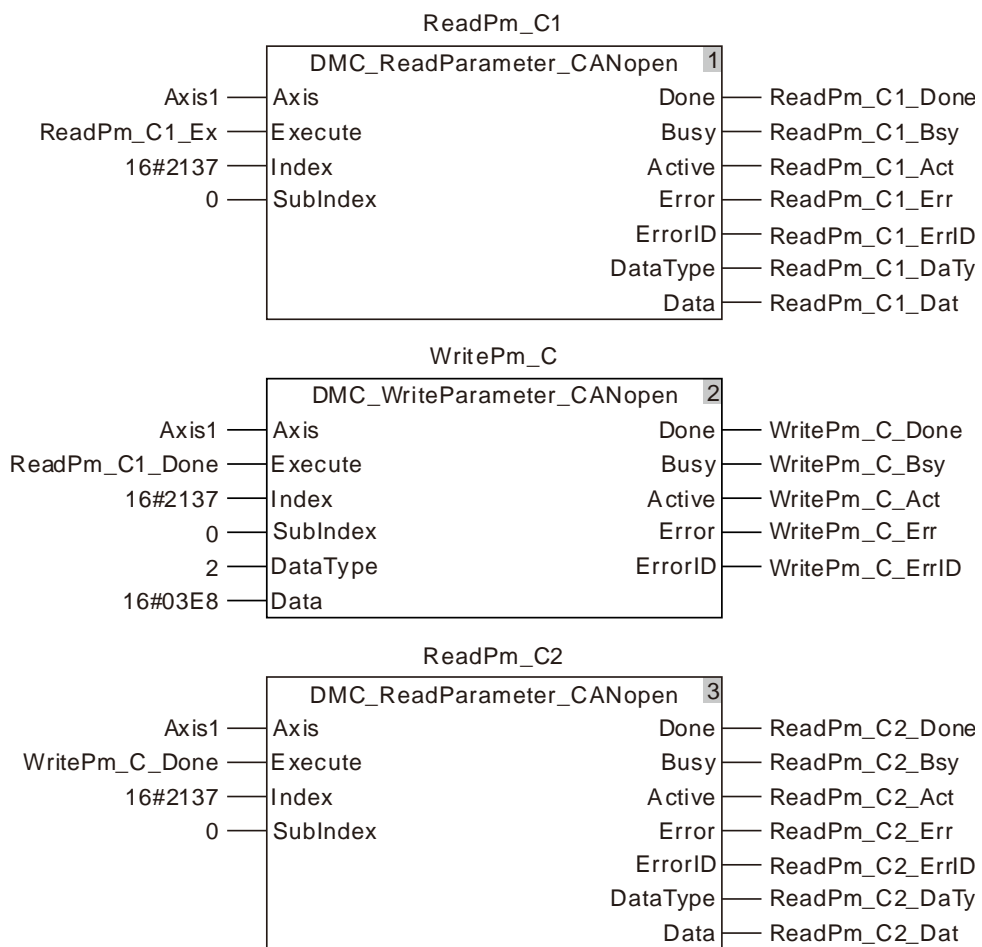

■ **Timing Chart**

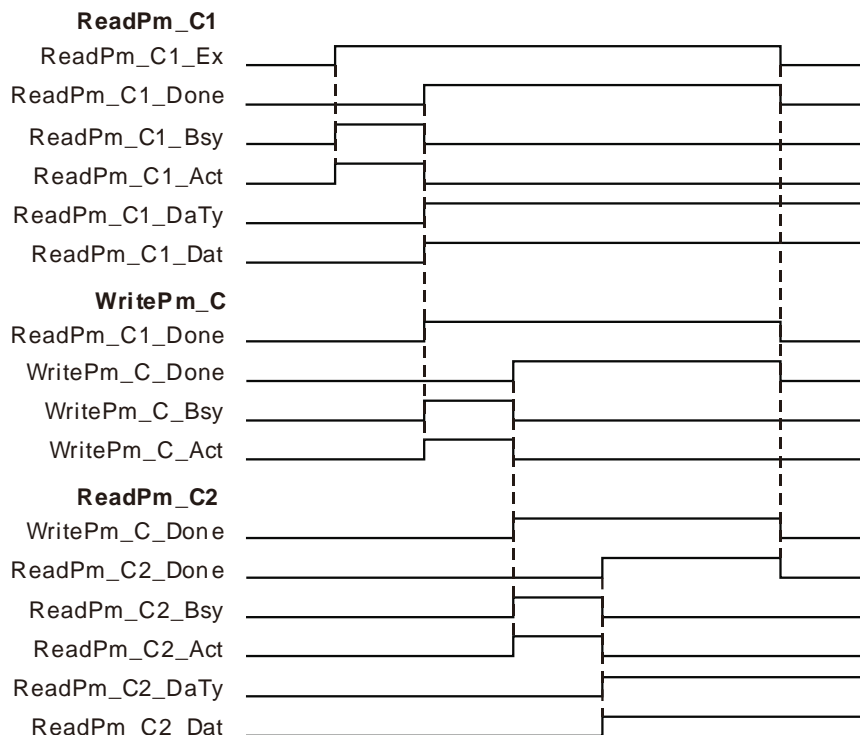

- ❖ The first DMC_ReadParameter_CANopen starts being executed as ReadPm_C1_Ex changes from FALSE to TRUE. When the execution of the first DMC_ReadParameter_CANopen is completed, ReadPm_C1_Done changes to TRUE, ReadPm_C1_DaTy = 2 and ReadPm_C1_Dat=5000.
That is, the content of the servo slave parameter P1-55 which is read is 5000. (The maximum speed of the servo is limited to 5000rpm.)
- ❖ As ReadPm_C1_Done changes from FALSE to TRUE, DMC_WriteParameter_CANopen starts being executed. When the DMC_WriteParameter_CANopen instruction execution is completed, WritePm_C_Done changes to TRUE. That is, 1000 is written as the content of the servo slave parameter P1-55. (The maximum speed of the servo is limited to 1000rpm.)
- ❖ The second DMC_ReadParameter_CANopen is executed as WritePm_C_Done changes from FALSE to TRUE. When the execution of the second DMC_ReadParameter_CANopen is completed, ReadPm_C2_Done changes to TRUE, ReadPm_C2_DaTy = 2 and ReadPm_C2_Dat=1000. That is, the read content of the servo slave parameter P1-55 is 1000. (The maximum speed of the servo is limited to 1000rpm.)

8.14.1.2 DMC_WriteParameter_CANopen

FB/FC	Explanation	Applicable model
FB	DMC_WriteParameter_CANopen is used to set a parameter value of a slave.	DVP15MC11T DVP15MC11T-06

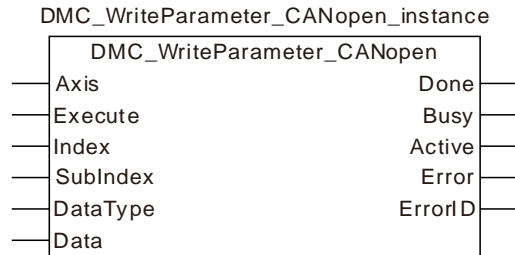

- Input Parameters

Parameter name	Function	Data type	Valid range (Default)	Validation timing
Axis	Specify the slave which is to be controlled by the instruction	USINT	1~127 (The variable value must be set)	When <i>Execute</i> changes from FALSE to TRUE
Execute	The instruction is executed when <i>Execute</i> changes from FALSE to TRUE.	BOOL	TRUE or FALSE (FALSE)	-
Index	The index of a parameter which is set	UINT		
SubIndex	The subindex of a parameter which is set	USINT		
DataType	The data type of the parameter which is set 1 : Byte, 2 : Word, 4 : Double Word.	USINT		
Data	The content value of the parameter which is set	UDINT		

- Notes:

1. The value of *DataType* must indicate the data type of the parameter which is set. If the filled value is incorrect, an error will occur in the instruction.
2. For the method of calculating the index and subindex of CANopen slave parameter, refer to Introduction of Axis Parameters in Chapter 9.

- Output Parameters

Parameter name	Function	Data type	Valid range
Done	TRUE when the instruction execution is completed.	BOOL	TRUE / FALSE
Busy	TRUE when the instruction is being executed.	BOOL	TRUE / FALSE
Active	TRUE when the axis is being controlled.	BOOL	TRUE / FALSE
Error	TRUE when there is an error.	BOOL	TRUE / FALSE
ErrorID	Contains error codes when an error occurs. Please refer to section 12.2 for the corresponding error code.	WORD	

- Output Update Timing

Parameter Name	Timing for changing to TRUE	Timing for changing to FALSE
Done	◆ When the writing of the parameter content is completed	◆ When <i>Execute</i> changes from TRUE to FALSE after the instruction execution is completed
Busy	◆ When <i>Execute</i> changes to TRUE	◆ When <i>Error</i> changes to TRUE ◆ When <i>Done</i> changes from FALSE to TRUE
Active	◆ When the slave starts being controlled by the instruction	◆ When <i>Error</i> changes to TRUE ◆ When <i>Done</i> changes from FALSE to TRUE
Error	◆ When an error occurs in the instruction execution or the input parameters for the instruction are illegal	◆ When <i>Execute</i> changes from TRUE to FALSE

● **Timing Chart**

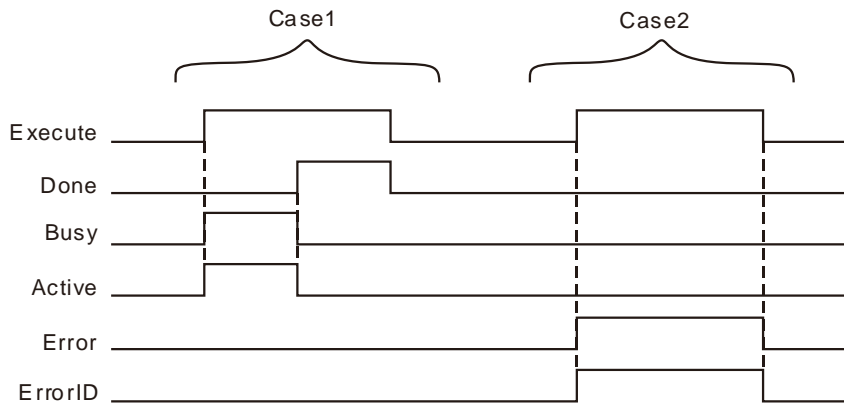

Case 1 : *Busy* and *Active* change to TRUE when *Execute* changes from FALSE to TRUE and one period later, *Done* changes to TRUE. When *Done* changes to TRUE, *Busy* and *Active* change to FALSE. When *Execute* changes from TRUE to FALSE, *Done* changes from TRUE to FALSE.

Case 2 : Before *DMC_WriteParameter_CANopen* is executed, the input parameter value such as axis No: 0 is illegal. After *Execute* changes from FALSE to TRUE, *Error* changes from FALSE to TRUE and *ErrorID* shows corresponding error codes. As *Execute* changes from TRUE to FALSE, *Error* changes from TRUE to FALSE and the content of *ErrorID* is cleared to 0.

● **Function**

DMC_WriteParameter_CANopen is used to set the parameter value of a slave. Users can specify the index and subindex of the parameter which is to be set.

8



Programming Example

Below is an example of one *DMC_WriteParameter_CANopen* instruction execution.

■ **The variable table and program**

Variable name	Data type	Initial value
<i>ReadPm_C1</i>	<i>DMC_ReadParameter_CANopen</i>	
<i>Axis1</i>	USINT	1
<i>ReadPm_C1_Ex</i>	BOOL	TRUE
<i>ReadPm_C1_Done</i>	BOOL	TRUE
<i>ReadPm_C1_Bsy</i>	BOOL	FALSE
<i>ReadPm_C1_Act</i>	BOOL	FALSE

Variable name	Data type	Initial value
ReadPm_C1_Err	BOOL	FALSE
ReadPm_C1_ErrID	WORD	FALSE
ReadPm_C1_DaTy	USINT	2
ReadPm_C1_Dat	UDINT	5000
WritePm_C	DMC_WriteParameter_CANopen	
WritePm_C_Done	BOOL	TRUE
WritePm_C_Bsy	BOOL	FALSE
WritePm_C_Act	BOOL	FALSE
WritePm_C_Err	BOOL	FALSE
WritePm_C_ErrID	WORD	FALSE
ReadPm_C2	DMC_ReadParameter_CANopen	
ReadPm_C2_Done	BOOL	TRUE
ReadPm_C2_Bsy	BOOL	FALSE
ReadPm_C2_Act	BOOL	FALSE
ReadPm_C2_Err	BOOL	FALSE
ReadPm_C2_ErrID	WORD	FALSE
ReadPm_C2_DaTy	USINT	2
ReadPm_C2_Dat	UDINT	1000

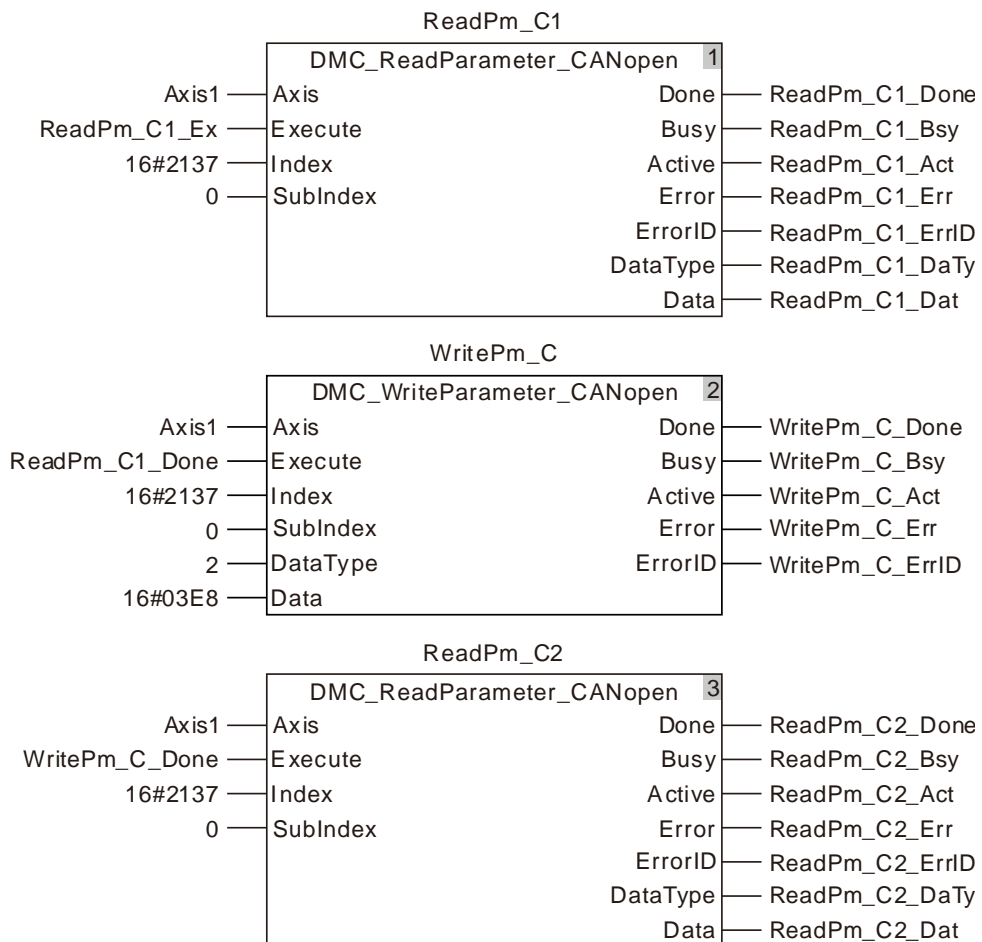

■ Timing chart

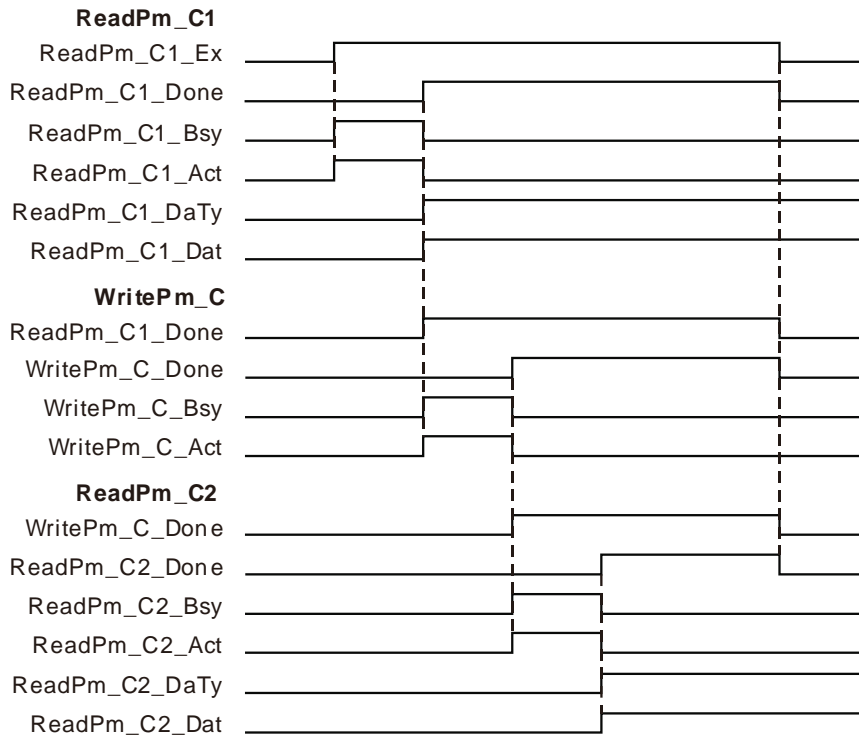

- ❖ When `ReadPm_C1_Ex` changes from FALSE to TRUE, the first `DMC_ReadParameter_CANOpen` starts being executed. After the execution of the first `DMC_ReadParameter_CANOpen` is completed, `ReadPm_C1_Done` changes to TRUE, `ReadPm_C1_DaTy` =2 and `ReadPm_C1_Dat`=5000. That is, the content of the servo slave parameter P1-55 which is read is 5000. (The maximum speed of the servo is limited to 5000rpm.)
- ❖ When `ReadPm_C1_Done` changes from FALSE to TRUE, the `DMC_WriteParameter_CANOpen` instruction starts being executed. After the execution of the `DMC_WriteParameter_CANOpen` instruction is completed, `WritePm_C_Done` changes to TRUE. That is, the content of the servo slave parameter P1-55 which is written is 1000. (The maximum speed of the servo is limited to 1000rpm.)
- ❖ When `WritePm_C_Done` changes from FALSE to TRUE, the second `DMC_ReadParameter_CANOpen` instruction starts being executed. After the execution of the second `DMC_ReadParameter_CANOpen` instruction is completed, `ReadPm_C2_Done` changes to TRUE, `ReadPm_C2_DaTy` =2 and `ReadPm_C2_Dat`=1000. That is, the content of the servo slave parameter P1-55 which is read is 1000. (The maximum speed of the servo is limited to 1000rpm.)

8.14.2 Ethernet Instructions

8.14.2.1 ETH_Link_Config

FB/FC	Explanation	Applicable model
FB	ETH_Link_Config is used for configuring parameters for MODBUS TCP data exchange at the LAN2 port of the motion controller.	DVP15MC11T DVP15MC11T-06

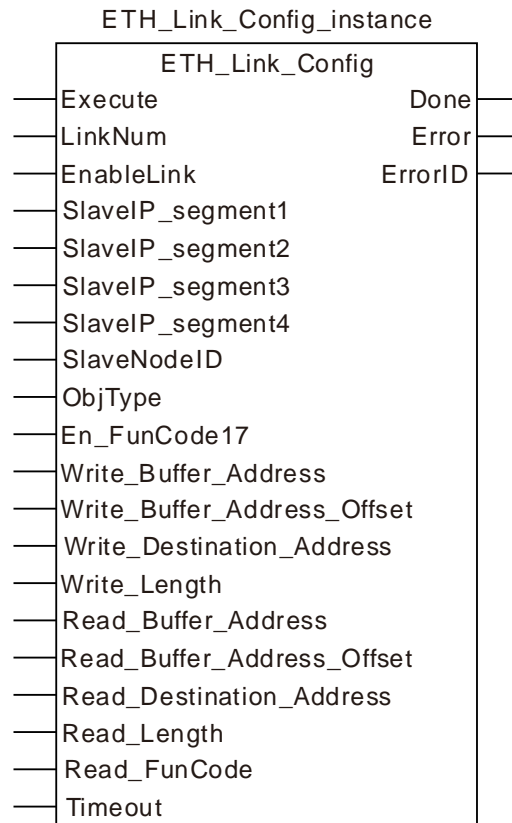

- **Input Parameters**

Parameter name	Function	Data type	Valid range (Default)	Validation timing
Execute	The instruction is executed when <i>Execute</i> changes from FALSE to TRUE.	BOOL	TRUE or FALSE (FALSE)	
LinkNum	Set the number of MODBUS TCP data exchange	UINT	1~16 (0)	When <i>Execute</i> changes from FALSE to TRUE
EnableLink	Enable or disable the link	BOOL	TRUE or FALSE (FALSE)	When <i>Execute</i> changes from FALSE to TRUE
SlaveIP_segment1	Set the first segment of the target IP address	USINT	0~255 (0)	When <i>Execute</i> changes from FALSE to TRUE
SlaveIP_segment2	Set the second segment of the target IP address	USINT	0~255 (0)	When <i>Execute</i> changes from FALSE to TRUE

Parameter name	Function	Data type	Valid range (Default)	Validation timing
SlaveIP_segment3	Set the third segment of the target IP address	USINT	0~255 (0)	When <i>Execute</i> changes from FALSE to TRUE
SlaveIP_segment4	Set the fourth segment of the target IP address	USINT	0~255 (0)	When <i>Execute</i> changes from FALSE to TRUE
SlaveNodeID	Set the node ID of the MODBUS slave	USINT	0~255 (0)	When <i>Execute</i> changes from FALSE to TRUE
ObjType	Set the type of slave registers to be read and written. 0 : Word register 1 : Bit register	USINT	0~1 (0)	When <i>Execute</i> changes from FALSE to TRUE
En_FunCode17	Set the function code 17 to be used or not.	BOOL	TRUE or FALSE (FALSE)	When <i>Execute</i> changes from FALSE to TRUE
Write_Buffer_Address	Specify the starting register of the master where data to be sent are stored.	UINT	%MW0~%MW32 767 %QW0~%QW63	When <i>Execute</i> changes from FALSE to TRUE
Write_Buffer_Address_Offset	Set the offset of the starting register of the master sending data. The setting value 1 means the offset is 1 word if data are written to the word registers of the slave. The setting value 1 means the offset is 1 bit if data are written to bit registers of the slave.	USINT	0~255 (0)	When <i>Execute</i> changes from FALSE to TRUE
Write_Destination_Address	Specify the starting address of the registers of the MODBUS slave receiving the data from the master	UINT	16#0~16#FFFF (0)	When <i>Execute</i> changes from FALSE to TRUE
Write_Length	The length of data to be written	UINT	Word register: 0~100 Bit register: 0~256 Word register or bit register can be set via the value of <i>ObjType</i> (0)	When <i>Execute</i> changes from FALSE to TRUE
Read_Buffer_Address	Specify the starting	UINT	%MW0~%MW32	When <i>Execute</i>

Parameter name	Function	Data type	Valid range (Default)	Validation timing
	register of the master where data received are stored.		767 %QW0~%QW63	changes from FALSE to TRUE
Read_Buffer_Address_Offset	Set the offset of the starting register of the master receiving data. The setting value 1 means the offset is 1 word if the word register of the slave is read. The setting value 1 means the offset is 1 bit if the bit register of the slave is read.	USINT	0~255 (0)	When <i>Execute</i> changes from FALSE to TRUE
Read_Destination_Address	Specify the starting address of the MODBUS slave that the master is to read	UINT	16#0~16#FFFF (0)	When <i>Execute</i> changes from FALSE to TRUE
Read_Length	The length of data to be read	UINT	0~100 for ObjType: 0; 0~256 for ObjType: 1; (0)	When <i>Execute</i> changes from FALSE to TRUE
Read_FunCode	Set the function code used for reading the bit register of the slave.	USINT	1~2 (0)	When <i>Execute</i> changes from FALSE to TRUE
Timeout	Set the time for the master to wait for the slave's response. The slave timeout occurs if the slave does not respond to the master request within the set time. Unit: ms	UINT	0~65535 (0)	When <i>Execute</i> changes from FALSE to TRUE

Note:

- The input parameters SlaveIP_segment1, SlaveIP_segment2, SlaveIP_segment3 and SlaveIP_segment4 are respectively segment 1~ segment 4 of the IP address of the slave. E.g. the slave IP is 192.168.1.10. So the input value of SlaveIP_segment1 is 192, SlaveIP_segment2 is 168; SlaveIP_segment3 is 1 and SlaveIP_segment4 is 10.
- The input parameters Write_Buffer_Address and Read_Buffer_Address mean the starting registers of the MODBUS TCP master where sent and received data are stored. The two input values must be entered. You can define variables and combine register addresses such as %MW0 for them.
- The input parameter ObjType is the data type of the read/written parameter. If ObjType is 0, that means to read and write the word registers of the slave and the range of Write_Length and Read_Length is 0~100. Write_Length and Read_Length can not be 0 simultaneously. If ObjType is 1, that means to read and write the bit registers of the slave and the range of Write_Length and Read_Length is 0~256. Write_Length and Read_Length can not be 0 simultaneously.

- When you read the bit registers of the slave, the value of Read_FunCode must be set to 01 or 02. You can choose the right function code according to the type of the Bit register through referring to corresponding module manual.

● **Output Parameters**

Parameter name	Function	Data type	Valid range
Done	TRUE When the configuration of parameters is completed.	BOOL	TRUE / FALSE
Error	TRUE when an error occurs in execution of the instruction.	BOOL	TRUE / FALSE
ErrorID	Contains the error code when an error occurs. Please refer to section 12.2 for the corresponding error ID.	WORD	

● **Output Update Timing**

Parameter Name	Timing for changing to TRUE	Timing for changing to FALSE
Done	◆ When the configuration of parameters is completed.	◆ When Execute changes from TRUE to FALSE
Error	◆ When an error occurs in the instruction execution or the input parameters for the instruction are illegal.	◆ When Execute changes from TRUE to FALSE

● **Output Update Timing Chart**

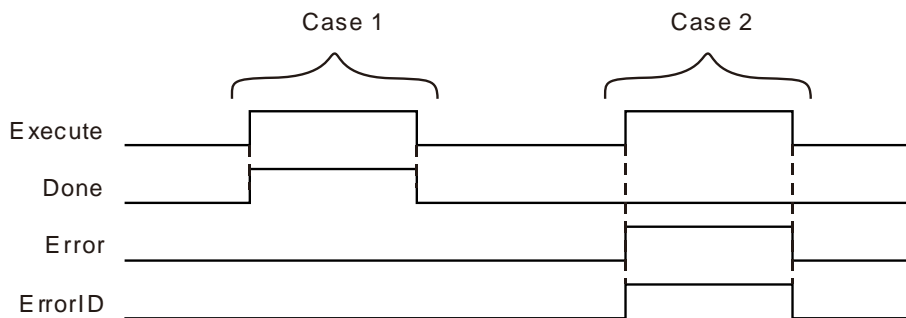

Case 1: When *Execute* changes from FALSE to TRUE, *Done* becomes TRUE and the configuration of parameters is successful. When *Execute* changes from TRUE to FALSE, *Done* changes from TRUE to FALSE.

Case 2: When *Execute* changes from FALSE to TRUE, *Error* becomes TRUE and *ErrorID* shows corresponding error code if some parameter is illegal. When *Execute* changes to FALSE, *Error* changes to FALSE and the value of *ErrorID* is cleared to 0.

● **Function**

ETH_Link_Config is used to configure MODBUS TCP parameters. The firmware of V1.01 and above supports the function.

- When the Modbus TCP master function of the motion controller is used, only the LAN2 port supports the function and the LAN1 port does not support the function.
- MODBUS TCP data must be sent by jointly using instruction ETH_Link_Config and ETH_Link_Manage
- If you modify parameters during instruction execution, the parameters are not written. After the instruction parameters are modified, the parameter will not be written until Execute is triggered again.
- If you modify parameters of ETH_Link_Config instruction, the new parameters will not take effect immediately until ETH_Link_Manage instruction is re-executed.

5. When word registers in the slave are read and written, the %MW registers of local device can be chosen as the registers for storing the read and written data. The storage registers range from %MW0~%MW32767. If registers exceed the range or other register is used, an error will occur in the instruction.
When bit registers in the slave are read and written, the %MW and %QW registers of local device can be chosen as the registers for storing the read and written data. The ranges of storage registers are %MW0~%MW32767 and %QW0~%QW63. If registers exceed the ranges or other register is used, an error will occur in the instruction.
6. When the bit registers of the slave are read and written and the offset value is 0, the PLC will begin to read or write Read_Length and Write_Length bits of data starting at bit0 of the starting register where the data are stored.
7. When the bit registers of the slave are read and written and the offset value is n which is not equal to 0, the PLC will begin to read or write Read_Length and Write_Length bits of data by offsetting n bits backward.
E.g. Write_Buffer_Address_Offset is 0, ObjType is 1, the register combined with Write_Buffer_Address is %MW0 and Write_Length is 5. Then the PLC will send the data in %MX0.0~%MX0.4 to the slave.
E.g. Write_Buffer_Address_Offset is 8, ObjType is 1, the register combined with Write_Buffer_Address is %MW0 and Write_Length is 5. Then the PLC will send the data in %MX1.0~%MX1.4 to the slave.
8. The parameter values of this instruction are only valid during the operation of the PLC. When the motion controller is repowered after power off, the parameters configured before the power off are all invalidated. The ETH_Link_Config instruction must be performed again if the configuration before the power off is needed to use.
9. When the MODBUS TCP master function of the motion controller is used, the motion controller conducts the data exchange with other slaves via the Ethernet LAN2 port of the motion controller.

8.14.2.2 ETH_Link_Manage

FB/FC	Explanation	Applicable model
FB	ETH_Link_Manage is used to enable and disable the MODBUS TCP data exchange.	DVP15MC11T DVP15MC11T-06

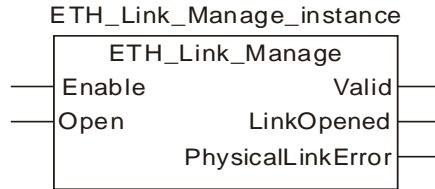

● Input Parameters

Parameter name	Function	Data type	Valid range (Default)	Validation timing
Enable	The instruction is executed when <i>Enable</i> changes from FALSE to TRUE.	BOOL	TRUE or FALSE (FALSE)	
Open	Enable or disable the MODBUS TCP data exchange.	BOOL	TRUE or FALSE (FALSE)	When <i>Enable</i> changes from FALSE to TRUE

Note:

ETH_Link_Manage is used to enable the MODBUS TCP data exchange after MODBUS TCP parameters are configured with ETH_Link_Config instruction.

● Output Parameters

Parameter name	Function	Data type	Valid range
Valid	TRUE when the outputs of the instruction are valid.	BOOL	TRUE / FALSE
LinkOpened	TRUE when the MODBUS TCP data exchange is enabled.	BOOL	TRUE / FALSE
PhysicalLinkError	TRUE when the physical link to the Ethernet interface of the PLC is disconnected.	BOOL	TRUE / FALSE

● Output Update Timing

Parameter Name	Timing for changing to TRUE	Timing for changing to FALSE
Valid	◆ When <i>Enable</i> changes to TRUE	◆ When <i>Enable</i> changes from TRUE to FALSE
LinkOpened	◆ When the link to the MODBUS TCP is successful.	◆ When <i>Enable</i> changes from TRUE to FALSE ◆ When <i>Open</i> changes from TRUE to FALSE ◆ When the physical link to the Ethernet interface of the CPU is disconnected.
PhysicalLinkError	◆ When <i>Open</i> is TRUE and the physical link to the Ethernet interface of the PLC is disconnected.	◆ When <i>Enable</i> changes from TRUE to FALSE ◆ When <i>LinkOpened</i> changes from FALSE to TRUE ◆ When the physical link to the Ethernet interface of the PLC is reconnected.

- **Output Update Timing Chart**

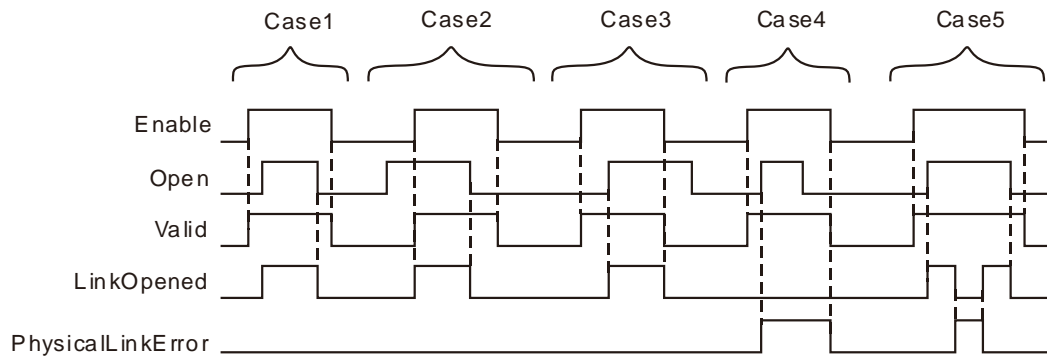

- Case 1 When *Enable* changes from FALSE to TRUE, *Valid* changes to TRUE. When *Open* changes from FALSE to TRUE, *LinkOpened* changes to TRUE. When *Open* changes from TRUE to FALSE, *LinkOpened* changes FALSE. When *Enable* changes from TRUE to FALSE, *Valid* changes to FALSE.
- Case 2 When *Enable* changes to FALSE, *Open* changes to TRUE and at the moment, the outputs of the instruction do not change. When *Enable* changes from FALSE to TRUE, *Valid* and *LinkOpened* change to TRUE. When *Open* changes to FALSE, *LinkOpened* changes to FALSE. When *Enable* changes from TRUE to FALSE, *Valid* changes to FALSE.
- Case 3 When *Enable* changes to TRUE, *Valid* changes to TRUE. When *Open* changes from FALSE to TRUE, *LinkOpened* changes to TRUE. When *Enable* changes from TRUE to FALSE, *Valid* and *LinkOpened* change to FALSE. Afterwards, changing *Open* from TRUE to FALSE will not affect the output result.
- Case 4 When *Enable* changes from FALSE to TRUE, *Valid* changes to TRUE. If there is a problem in the link to LAN2 of the motion controller at the moment, *PhysicalLinkError* changes to TRUE if *Open* changes to TRUE; *PhysicalLinkError* does not change to FALSE if *Open* changes to FALSE and *Valid* and *PhysicalLinkError* changes to FALSE simultaneously if *Enable* changes from TRUE to FALSE.
- Case 5 If the link to LAN2 of the motion controller is disconnected during the instruction execution, *PhysicalLinkError* changes to TRUE and meanwhile *LinkOpened* changes to FALSE. When the link to LAN2 of the motion controller is restored, *PhysicalLinkError* changes to FALSE and meanwhile *LinkOpened* changes to TRUE.

- **Function**

ETH_Link_Manage is used to start the MODBUS TCP communication. The firmware of V1.01 and above supports the function.

1. After the input *Enable* of ETH_Link_Manage changes to TRUE and *Open* is set to TRUE, the MODBUS TCP data start being sent if the physical Ethernet interface of the PLC is connected normally. As *Open* changes from TRUE to FALSE, the PLC stops sending the MODBUS TCP data.
2. If *Enable* is set to FALSE during the instruction execution, the outputs of ETH_Link_Manage all change to FALSE. But the PLC will not stop sending the MODBUS TCP data. The link will not be closed until *Open* is set to FALSE only as *Enable* is TRUE.
3. The error message from the slave or communication timeout has no impact on the instruction execution.

8.14.2.3 ETH_Link_Status

FB/FC	Explanation	Applicable model
FB	ETH_Link_Status is used to watch if an error occurs in the MODBUS TCP link which the number corresponds to or if the slave replies with error codes.	DVP15MC11T DVP15MC11T-06

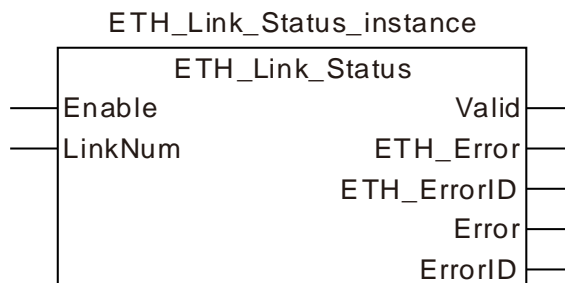

● **Input Parameters**

Parameter name	Function	Data type	Valid range (Default)	Validation timing
Enable	The instruction is validated when <i>Enable</i> changes from FALSE to TRUE.	BOOL	TRUE or FALSE (FALSE)	
LinkNum	The number of MODBUS TCP link to be monitored.	UINT	1~16 (0)	When <i>Enable</i> changes from FALSE to TRUE

● **Output Parameters**

Parameter name	Function	Data type	Valid range
Valid	TRUE when the outputs of the instruction are valid.	BOOL	TRUE / FALSE
ETH_Error	TRUE when an error occurs in the MODBUS TCP data exchange.	BOOL	TRUE / FALSE
ETH_ErrorID	MODBUS TCP data exchange error code. Refer to the table in the following Function section. If the <i>ETH_ErrorID</i> value is 1~10, refer to the relevant slave manual for corresponding error ID explanation.	WORD	
Error	TRUE when an error occurs in the instruction execution.	BOOL	TRUE / FALSE
ErrorID	Contains error codes when an error occurs in the instruction execution. Please refer to section 12.2 for the corresponding error code.	WORD	

● **Output Update Timing**

Parameter Name	Timing for changing to TRUE	Timing for changing to FALSE
Valid	◆ When <i>Enable</i> changes to TRUE.	◆ When <i>Enable</i> changes from TRUE to FALSE.
ETH_Error	◆ When an error occurs in MODBUS TCP data exchange.	◆ When <i>Enable</i> changes from TRUE to FALSE.

Parameter Name	Timing for changing to TRUE	Timing for changing to FALSE
		◆ When the MODBUS TCP data exchange is restored to normal.
Error	◆ When an error occurs in the instruction execution.	◆ When <i>Enable</i> changes from TRUE to FALSE. ◆ When the correct parameter value is filled.

● **Output Update Timing Chart**

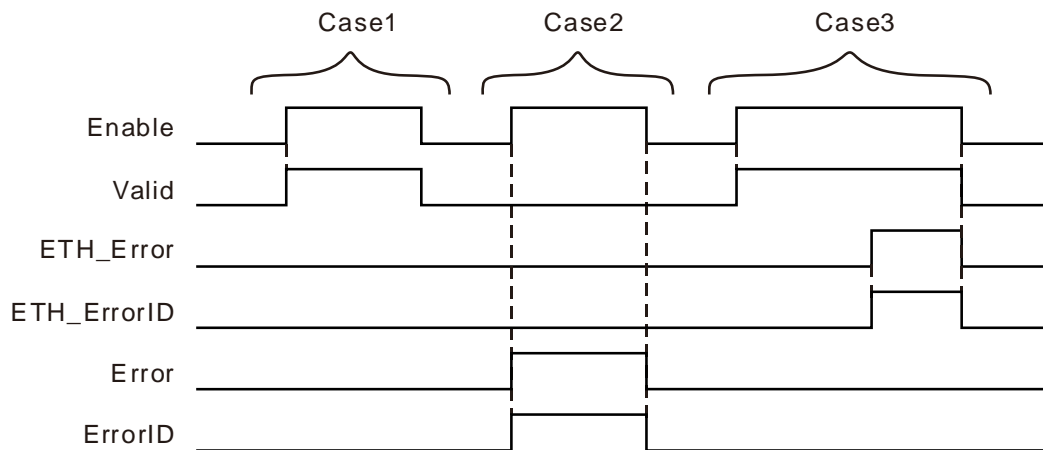

- Case 1 When *Enable* changes to TRUE, *Valid* changes to TRUE. When *Enable* changes to FALSE, *Valid* changes to FALSE.
- Case 2 When an error occurs while *Enable* is TRUE, *Error* changes to TRUE and *ErrorID* shows corresponding error code. *Error* changes to FALSE and the value in *ErrorID* changes to 0 when *Enable* changes to FALSE.
- Case 3 When *Enable* changes to TRUE, *Valid* changes to TRUE. *ETH_Error* changes to TRUE and *ETH_ErrorID* shows corresponding error code when the MODBUS TCP data sending fails or timeout occurs during the instruction execution. When *Enable* changes to FALSE, *ETH_Error* changes to FALSE and *ETH_ErrorID* shows corresponding error code.

● **Function**

ETH_Link_Status is used for watching if an error occurs in the corresponding MODBUS TCP link or the slave replies with error codes. The firmware of V1.01 and above supports the function.

Error code	Description	How to deal with
101	The TCP link is disabled.	1. Check if the Ethernet connection is normal. 2. Re-execute ETH_Link_Manage instruction to enable the MODBUS TCP data exchange.
102	TCP link timeout	1. Check if the Ethernet connection is normal. 2. Check if the settings for the parameters of ETH_Link_Config instruction are correct.

Error code	Description	How to deal with
103	MODBUS TCP message response timeout	<ol style="list-style-type: none"> 1. Check if the Ethernet connection is normal. 2. Increase the timeout period by modifying the value of <i>Timeout</i> parameter of ETH_Link_Config instruction.
104	Reserved	-
105	Reserved	-
106	Transaction identifier error (in the message header)	Make sure that the format of the response message from the slave is correct.
107	Protocol identifier error (in the message header)	Make sure that the format of the response message from the slave is correct.
108	Modbus TCP message length error (in the message header)	Make sure that the length of the response message from the slave is correct.
109	Reserved	-
110	The establishment of the link is re-performed when the TCP link is not disabled.	Disable the current link before re-establishing the link.

8.14.2.4 MODBUS TCP Data Exchange Example



Programming Example 1

■ Example of reading and writing word registers in the slave

➤ Example explanation

1. The motion controller is the MODBUS TCP master, DVP12SE is the MODBUS TCP slave and the IP address of DVP12SE is 192.168.1.10.
2. The motion controller writes the values in %MW10~%MW19 to D0~D9 in DVP12SE, then reads the values in D100~D109 in DVP12SE and stores the read values in %MW110~%MW119.

➤ Variable table and program

Variable name	Address	Data type	Initial value
ETH_Link_Config0		ETH_Link_Config	
Config0_Ex		BOOL	
Config0_En		BOOL	TRUE
Config0_SIP1		USINT	192
Config0_SIP2		USINT	168
Config0_SIP3		USINT	1
Config0_SIP4		USINT	10
Config0_SNodeID		USINT	0
Config0_OT		USINT	0
Config0_En_FunCode17		BOOL	FALSE
Config0_WBf_Add	%MW0	UINT	
Config0_WBf_Off		USINT	10
Config0_WDes_Add		UINT	16#1000
Config0_WLTH		UINT	10

Variable name	Address	Data type	Initial value
Config0_RBF_ADD	%MW100	UINT	
Config0_RBF_OFF		USINT	10
Config0_RDES_ADD		UINT	16#1064
Config0_RLTH		UINT	10
Config0_R_Code		USINT	0
Config0_T		UINT	1000
Config0_Done		BOOL	
Config0_Err		BOOL	
Config0_ErrID		WORD	
ETH_Link_Manage0		ETH_Link_Manage	
MA_En		BOOL	
MA_Open		BOOL	
MA_Valid		BOOL	
MA_LinkOpen		BOOL	
MA_PhyErr		BOOL	
ETH_Link_Status0		ETH_Link_Status	
STA_En		BOOL	
STA_Valid		BOOL	
STA_ETH_Err		BOOL	
STA_ETH_ErrID		WORD	
STA_Err		BOOL	
STA_ErrID		WORD	

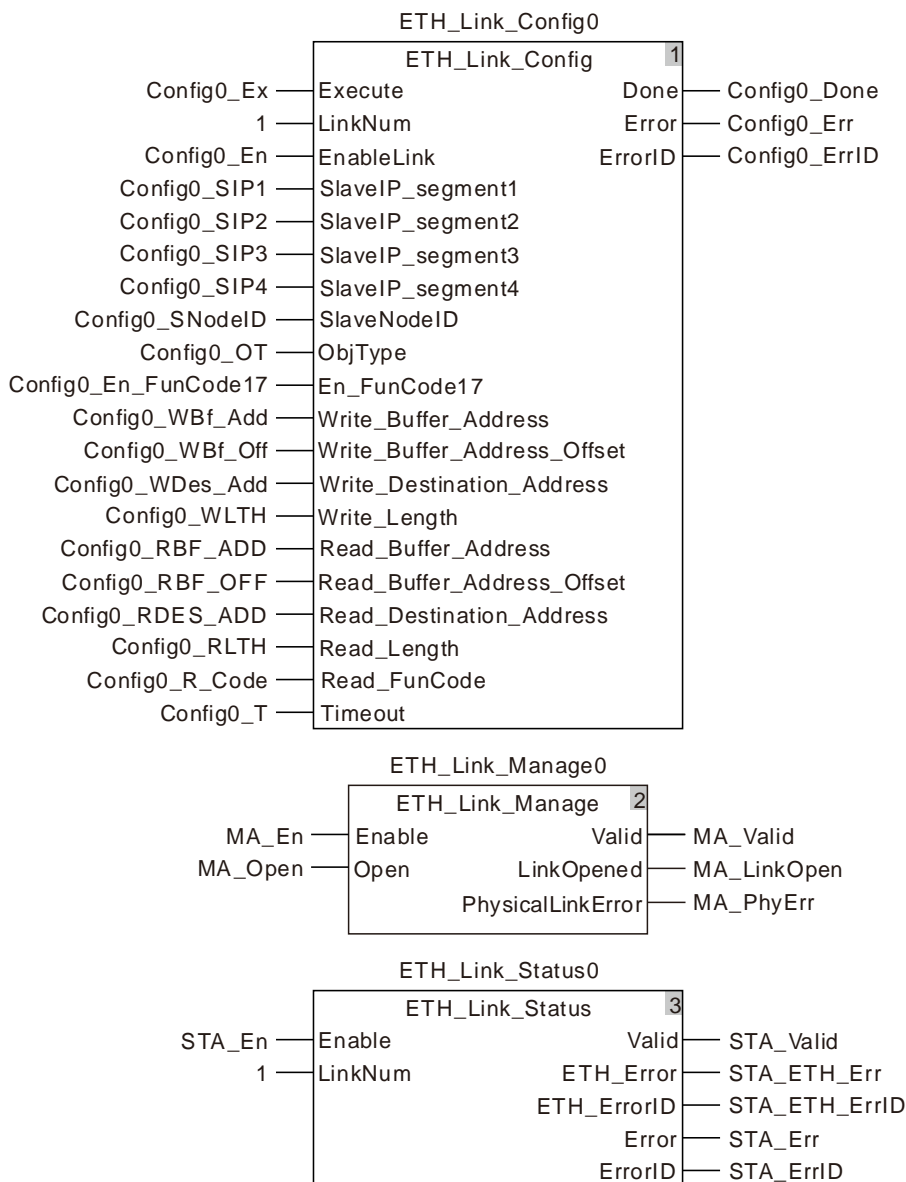

➤ **Operation steps and data exchange explanation**

- Combine Config0_WBf_Add and Config0_RBF_ADD with %MW0 and %MW100 respectively. The initial values of Config0_WBf_Off and Config0_Rbf_OFF are 10. Perform the online function after the program compiling and downloading is successful.
- Set Config0_Ex to TRUE. After ETH_Link_Config instruction execution is completed, set MA_En to TRUE and then MA_Open to TRUE. After the output MA_LinkOpen of ETH_Link_Manage instruction changes to TRUE, the motion controller starts to exchange data with 12SE.

Via the ETH_Link_Status instruction, current communication status can be watched. The corresponding relationships between the motion controller and DVP12SE are shown in the following table.

%MW registers in the motion controller		D registers in DVP12SE
%MW10	➡	D0
%MW11		D1
%MW12		D2
.....	

%MW registers in the motion controller		D registers in DVP12SE
%MW18	←	D8
%MW19		D9
%MW110		D100
%MW111		D101
%MW112		D102
.....	
%MW118		D108
%MW119		D109



Programming Example 2

■ Example of reading and writing bit registers in the slave

➤ Example explanation

1. The motion controller is the MODBUS TCP master, DVP12SE is the MODBUS TCP slave and the IP address of DVP12SE is 192.168.1.10.
2. The motion controller writes the values in %MX0.0~%MX0.7 to Y0~Y7 in DVP12SE, then reads the values in Y20~Y27 in DVP12SE and stores the read values in %MX2.0~%MX2.7.

➤ Variable table and program

Variable name	Address	Data type	Initial value
ETH_Link_Config1		ETH_Link_Config	
Config1_Ex		BOOL	
Config1_En		BOOL	TRUE
Config1_SIP1		USINT	192
Config1_SIP2		USINT	168
Config1_SIP3		USINT	1
Config1_SIP4		USINT	10
Config1_SNodeID		USINT	0
Config1_OT		USINT	1
Config1_En_FunCode17		BOOL	FALSE
Config1_WBf_Add	%MW0	UINT	
Config1_WBf_Off		USINT	0
Config1_WDes_Add		UINT	16#0500
Config1_WLTH		UINT	8
Config1_RBF_ADD	%MW1	UINT	
Config1_RBF_OFF		USINT	0
Config1_RDES_ADD		UINT	16#0510
Config1_RLTH		UINT	8
Config1_R_Code		USINT	1
Config1_T		UINT	1000

Variable name	Address	Data type	Initial value
Config1_Done		BOOL	
Config1_Err		BOOL	
Config1_ErrID		WORD	
ETH_Link_Manage1		ETH_Link_Manage	
MA1_En		BOOL	
MA1_Open		BOOL	
MA1_Valid		BOOL	
MA1_LinkOpen		BOOL	
MA1_PhyErr		BOOL	
ETH_Link_Status1		ETH_Link_Status	
STA1_En		BOOL	
STA1_Valid		BOOL	
STA1_ETH_Err		BOOL	
STA1_ETH_ErrID		WORD	
STA1_Err		BOOL	
STA1_ErrID		WORD	

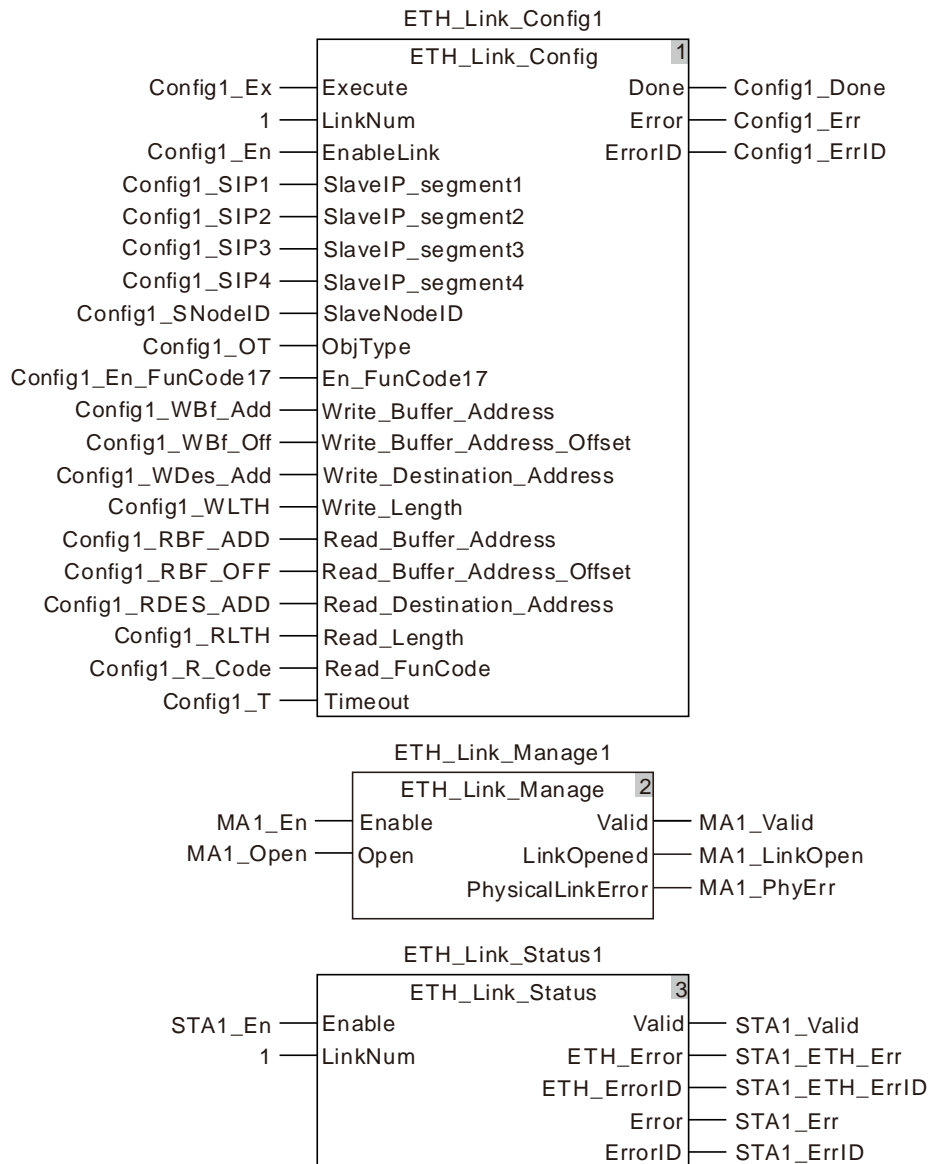

➤ **Operation steps and data exchange explanation**

1. Combine Config1_WBf_Add and Config1_RBF_ADD with %MW0 and %MW1 respectively. Set the values of Config1_WLTH and Config1_RLTH to 8 and Config1_OT to 1. Set the values of Config1_WDes_Add and Config1_RDes_Add to 16#0500 and 16#0510 respectively and Config1_R_Code to 1.
2. After the program compiling and downloading is successful, perform the online. Set Config1_Exec to TRUE. After ETH_Link_Config instruction execution is completed, set MA1_En to TRUE and then MA1_Open to TRUE. After the output MA1_LinkOpen of ETH_Link_Manage instruction changes to TRUE, the motion controller starts to exchange data with 12SE.

Via the ETH_Link_Status instruction, current communication status can be watched. The corresponding relationships between the motion controller and DVP12SE are shown in the following table.

Devices in the motion controller		Bit devices Y in DVP12SE
%MX0.0	➔	Y0
%MX0.1		Y1
%MX0.2		Y2
.....	
%MX0.6		Y6
%MX0.7		Y7
%MX2.0		➔
%MX2.1	Y21	
%MX2.2	Y22	
.....	
%MX2.6	Y26	
%MX2.7	Y27	

8.14.2.5 ETH_Link_Config_Ext

FB/FC	Explanation	Applicable model
FB	ETH_Link_Config_Ext is used to configure the cycle time and link duration for MODBUS TCP data exchange.	DVP15MC11T DVP15MC11T-06

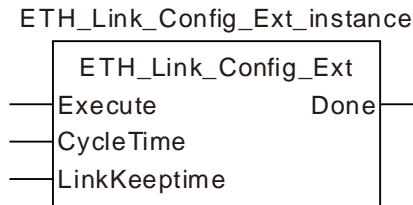

● Input Parameters

Parameter name	Function	Data type	Valid range (Default)	Validation timing
Execute	The instruction is executed when <i>Execute</i> changes from FALSE to TRUE.	BOOL	TRUE or FALSE (FALSE)	
CycleTime	The cycle time the master sends MODBUS TCP data. (Unit: milliseconds)	ARRAY [1..16] OF UINT	0~65535 (0)	When <i>Execute</i> changes from FALSE to TRUE.
LinkKeepTime	The link duration of the master (Unit: seconds)	ARRAY [1..16] OF UINT	0~65535 (0)	When <i>Execute</i> changes from FALSE to TRUE.

Note:

1. Every element of the values in *CycleTime* and *LinkKeepTime* corresponds to the number in a *ETH_Link_Config* instruction. For example, the first element of *CycleTime* value corresponds to the data-sending cycle time of the number 1.
2. The unit of *CycleTime* is milliseconds (ms) and *LinkKeepTime* is seconds (s).
3. *LinkKeepTime* is the link duration (unit:seconds). If there is no data exchange between the master and slave within the time specified by *LinkKeepTime*, the controller will disconnect the link to the slave automatically.

● Output Parameters

Parameter name	Function	Data type	Valid range
Done	TRUE when the instruction execution is completed.	BOOL	TRUE / FALSE

● Output Update Timing

Parameter Name	Timing for changing to TRUE	Timing for changing to FALSE
Done	◆ When <i>Execute</i> changes to TRUE.	◆ When <i>Execute</i> changes from TRUE to FALSE.

● Function

When the MODBUS TCP master function of the controller is used, *ETH_Link_Config_Ext* can be used to set the cycle time and link duration for MODBUS TCP data exchange. The firmware of V1.01 and above supports the function.

1. The *ETH_Link_Config_Ext* instruction can be used to set the cycle time and link duration for MODBUS TCP data exchange. The instruction can also be used in the configuration of MODBUS TCP parameters. And it can still be used in the MODBUS TCP master function of the controller. One piece of MODBUS TCP data sending is finished and then another piece will be sent out immediately. The link duration is

30s by default.

2. The parameter value which is modified during the instruction execution will not be written. The new parameter value of the instruction will be written only after *Execute* of the instruction is retrigged.
3. ETH_Link_Config_Ext and ETH_Link_Config has no relation in the execution sequence. The parameters of ETH_Link_Config_Ext will not take effect unless ETH_Link_Config_Ext is executed prior to ETH_Link_Manage.

8.14.2.6 ETH_SetServerlinkkeepertime

FB/FC	Explanation	Applicable model
FB	ETH_SetServerlinkkeepertime is used to set the link duration as the controller serves as the MODBUS TCP slave.	DVP15MC11T DVP15MC11T-06

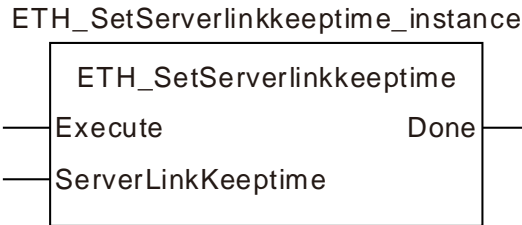

● Input Parameters

Parameter name	Function	Data type	Valid range (Default)	Validation timing
Execute	The instruction is executed when <i>Execute</i> changes from FALSE to TRUE.	BOOL	TRUE or FALSE (FALSE)	
ServerLinkKeepertime	Link duration when the controller works as the MODBUS TCP slave (Unit: seconds)	UINT	0~65535 (0)	When <i>Execute</i> changes from FALSE to TRUE.

Note:

When the *ServerLinkKeepertime* parameter is set to 0 or blank, the default link duration of the MODBUS TCP slave which the controller serves as is 30s.

● Output Parameters

Parameter name	Function	Data type	Valid range
Done	TRUE when the instruction execution is completed.	BOOL	TRUE / FALSE

● Output Update Timing

Parameter Name	Timing for changing to TRUE	Timing for changing to FALSE
Done	◆ When <i>Execute</i> changes from FALSE to TRUE.	◆ When <i>Execute</i> changes from TRUE to FALSE.

● Function

ETH_SetServerlinkkeepertime is used to set the link duration as the controller serves as the MODBUS TCP slave.

- The *ServerLinkKeepertime* value is valid only when the controller works as the MODBUS TCP slave. When the controller works as the MKODBUS TCP master, the execution of the ETH_SetServerlinkkeepertime instruction will have no impact on the MODBUS TCP master function.
- If there is no data exchange between the controller slave and the master within the time specified by *ServerLinkKeepertime*, the controller slave will disconnect the link to the MODBUS TCP master automatically.
- The instruction can only set the link duration of the MODBUS TCP slave which the LAN2 port of the motion controller works as.

8.14.2.7 ETH_Socket_Manage

FB/FC	Explanation	Applicable model
FB	ETH_Socket_Manage is used for managing Socket TCP/UDP.	DVP15MC11T DVP15MC11T-06

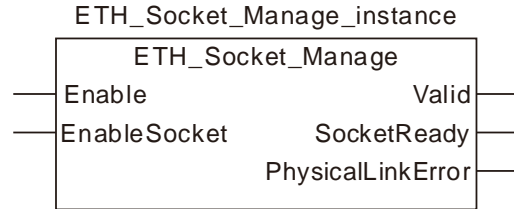

● **Input Parameters**

Parameter name	Function	Data type	Valid range (Default)	Validation timing
Enable	The instruction is executed when <i>Enable</i> changes from FALSE to TRUE.	BOOL	TRUE or FALSE (FALSE)	
EnableSocket	Enable the Socket.	BOOL	TRUE or FALSE (FALSE)	When <i>Enable</i> changes from FALSE to TRUE

Note:

ETH_Socket_Manage is to enable the Socket function. Other Socket-related instructions can not be used until the instruction is executed.

● **Output Parameters**

Parameter name	Function	Data type	Valid range
Valid	TRUE when the instruction output is valid.	BOOL	TRUE/FALSE
SocketReady	TRUE when enabling the Socket is successful.	BOOL	TRUE/FALSE
PhysicalLinkError	TRUE when the physical connection to Ethernet port of the controller is disconnected.	BOOL	TRUE/FALSE

■ **Output Update Timing**

Parameter Name	Timing for changing to TRUE	Timing for changing to FALSE
Valid	◆ When <i>Enable</i> changes to TRUE.	◆ When <i>Enable</i> changes from TRUE to FALSE.
SocketReady	◆ When enabling the Socket is successful.	◆ When <i>Enable</i> changes from TRUE to FALSE. ◆ When <i>EnableSocket</i> changes from TRUE to FALSE.
PhysicalLinkError	◆ When <i>Enable</i> changes to TRUE and the physical connection to Ethernet port LAN2 of the controller is disconnected.	◆ When <i>Enable</i> changes from TRUE to FALSE. ◆ When the physical connection to Ethernet port LAN2 of the controller is returned to normal.

■ Output Update Timing Chart

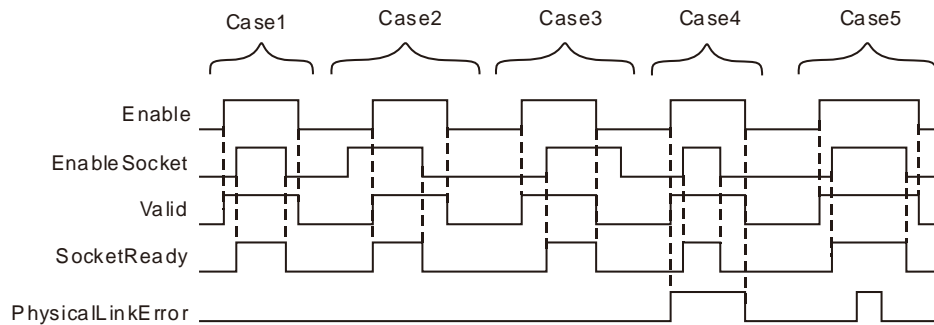

- Case 1 When *Enable* changes from FALSE to TRUE, *Valid* changes to TRUE. When *EnableSocket* changes from FALSE to TRUE, *SocketReady* changes to TRUE. When *EnableSocket* changes from TRUE to FALSE, *SocketReady* changes FALSE. When *Enable* changes from TRUE to FALSE, *Valid* changes to FALSE.
- Case 2 When *Enable* is FALSE and *EnableSocket* changes TRUE, the outputs of the instruction keep unchanged. When *Enable* changes from FALSE to TRUE, *Valid* and *SocketReady* both change to TRUE. When *EnableSocket* changes to FALSE, *SocketReady* changes to FALSE. When *Enable* changes from TRUE to FALSE, *Valid* changes to FALSE.
- Case 3 When *Enable* changes to TRUE, *Valid* changes to TRUE. When *EnableSocket* changes from FALSE to TRUE, *SocketReady* changes to TRUE. When *Enable* changes from TRUE to FALSE, *Valid* and *SocketReady* both change to FALSE. After that, changing *EnableSocket* from TRUE to FALSE will not affect the output of the instruction.
- Case 4 When *Enable* changes from FALSE to TRUE, *Valid* changes to TRUE. If there is a problem with 15MC's LAN2 port connection at the moment, *PhysicalLinkError* will change to TRUE as *Enable* changes to TRUE. As *EnableSocket* changes to TRUE, *SocketReady* changes to TRUE and the state of *PhysicalLinkError* will keep unchanged. As *EnableSocket* changes from TRUE to FALSE, *SocketReady* changes to FALSE. As *Enable* changes from TRUE to FALSE, *Valid* and *PhysicalLinkError* both change to FALSE.
- Case 5 If the connection to LAN2 port of the controller is disconnected during the instruction execution, *PhysicalLinkError* changes to TRUE and meanwhile the state of *SocketReady* keeps unchanged. When the connection to LAN2 of the controller is returned to normal, *PhysicalLinkError* changes to FALSE.

● Function

ETH_Socket_Manage is used for enabling Socket. The firmware of V1.02 and above supports the function. The firmware of V1.02 and above supports the function.

1. If *Enable* is set to FALSE during the instruction execution, all outputs of ETH_Link_Manage change to FALSE. But the controller will not disable the Socket. The Socket can be disabled by setting *EnableSocket* to FALSE only as *Enable* is TRUE.
2. The instruction execution will not be affected when there is an error message or communication timeout sent back from the target device.

8.14.2.8 ETH_Socket_Config

FB/FC	Explanation	Applicable model
FB	ETH_Socket_Config is used for configuring Socket parameters.	DVP15MC11T DVP15MC11T-06

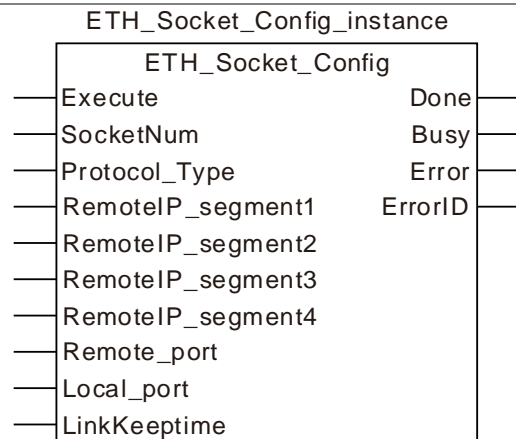

● Input Parameters

Parameter name	Function	Data type	Valid range (Default)	Validation timing
Execute	The instruction is executed when <i>Execute</i> changes from FALSE to TRUE.	BOOL	TRUE or FALSE (FALSE)	
SocketNum	Specify the number of the Socket.	USINT	1~8 (0)	When <i>Execute</i> changes from FALSE to TRUE.
Protocol_Type	Socket connection mode: 0: Socket UDP 1: Socket TCP	USINT	0: Socket UDP 1: Socket TCP (0)	When <i>Execute</i> changes from FALSE to TRUE.
RemotelIP_segment 1	Set the first segment of the remote IP address.	USINT	0~255 (0)	When <i>Execute</i> changes from FALSE to TRUE.
RemotelIP_segment 2	Set the second segment of the remote IP address.	USINT	0~255 (0)	When <i>Execute</i> changes from FALSE to TRUE.
RemotelIP_segment 3	Set the third segment of the remote IP address.	USINT	0~255 (0)	When <i>Execute</i> changes from FALSE to TRUE.
RemotelIP_segment 4	Set the fourth segment of the remote IP address.	USINT	0~255 (0)	When <i>Execute</i> changes from FALSE to TRUE.
Remote_port	Set the number of the remote port.	UINT	0~65535 (0)	When <i>Execute</i> changes from FALSE to TRUE.
Local_port	Set the number of the local port.	UINT	0~65535 (0)	When <i>Execute</i> changes from

Parameter name	Function	Data type	Valid range (Default)	Validation timing
				FALSE to TRUE.
LinkKeepTime	Set the period of time for the connection (s) .	UINT	65535 (0)	When <i>Execute</i> changes from FALSE to TRUE.

Note:

- The input parameters *RemoteIP_segment1*, *RemoteIP_segment2*, *RemoteIP_segment3* and *RemoteIP_segment4* respectively represent the first segment to the fourth segment of the target IP address. For example, if the target IP is 192.168.1.10, the input value of *SlaveIP_segment1* is 192, *SlaveIP_segment2* is 168, *SlaveIP_segment3* is 1 and *SlaveIP_segment4* is 10.
- The parameter *LinkKeepTime* means the duration time of connection with the unit of seconds. When there is no data transmission for the built link within the period of time, the controller will automatically abort the connection.

- Output Parameters**

Parameter name	Function	Data type	Valid range
Done	TRUE when the configuration of parameters is completed.	BOOL	TRUE/FALSE
Busy	TRUE when the instruction is being executed.	BOOL	TRUE/FALSE
Error	TRUE when an error occurs in the instruction execution.	BOOL	TRUE/FALSE
ErrorID	Contains error codes when an error occurs in the instruction execution. Please refer to section 12.2 for the corresponding error code.	WORD	

- Output Update Timing**

Parameter Name	Timing for changing to TRUE	Timing for changing to FALSE
Done	◆ When the configuration of parameters is completed.	◆ When <i>Execute</i> changes from TRUE to FALSE.
Busy	◆ When <i>Execute</i> changes to TRUE.	◆ When <i>Done</i> changes from FALSE to TRUE.
Error	◆ When input parameters of the instruction are illegal.	◆ When <i>Execute</i> changes from TRUE to FALSE.

■ **Output Update Timing Chart**

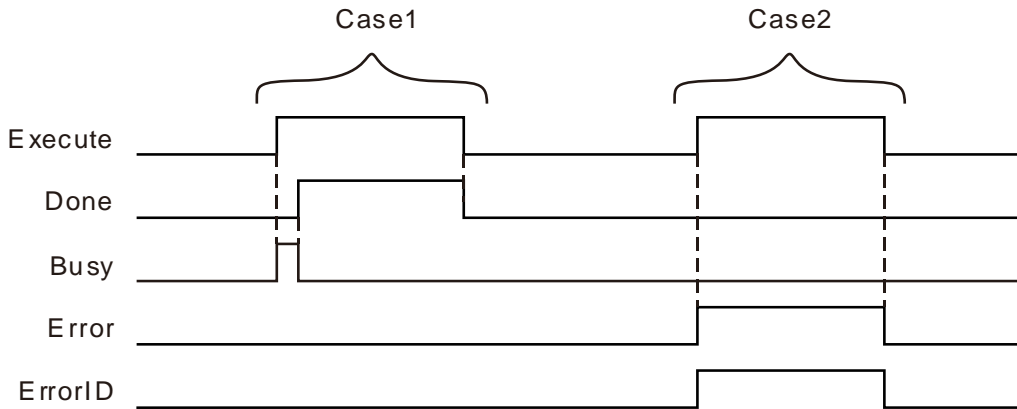

Case 1 When *Execute* changes from FALSE to TRUE, *Busy* changes to TRUE and the parameter writing succeeds. One cycle later, *Done* changes to TRUE and *Busy* changes to FALSE. When *Execute* changes from TRUE to FALSE, *Done* changes from TRUE to FALSE.

Case 2 When *Execute* changes from FALSE to TRUE, *Error* changes to TRUE and *ErrorID* shows corresponding error code if the parameter values writing is illegal. When *Execute* changes to FALSE, *Error* changes to FALSE and the vauel in *ErrorID* changes to 0.

● **Function**

ETH_Socket_Config is used for configuring Socket parameters. The firmware of V1.02 and above supports the function.

1. During the execution of ETH_Socket_Config, the modified parameter values will not be written unless you retrigger the input *Execute* after instruction parameter values are modified.
2. If you retrigger the instruction to execute when current link is not disconnected, the instruction will report an error.
3. The controller automatically allocates a local port to current link when the value of *Local_port* is set to 0. When Socket TCP server mode is selected, the value of *Local_port* can not be set to 0 and one local port which is a non 502 port must be set for the controller to monitor the port number.
4. When Socket TCP server mode is selected for the controller, the controller will select a remote host according to the values of the parameter *RemoteIP_segment1~4* or *Remote_port* if the value of the paramter *RemoteIP_segment1~4* or *Remote_port* is not set to 0. If the IP address of the remote host or port number is inconsistent with that of *RemoteIP_segment1~4* or *Remote_port*, the controller will disconnect the connection and stop monitoring local port set in current link.

8.14.2.9 ETH_Socket_Open

FB/FC	Explanation	Applicable model
FB	ETH_Socket_Open is used for enabling Socket TCP/UDP protocol.	DVP15MC11T DVP15MC11T-06

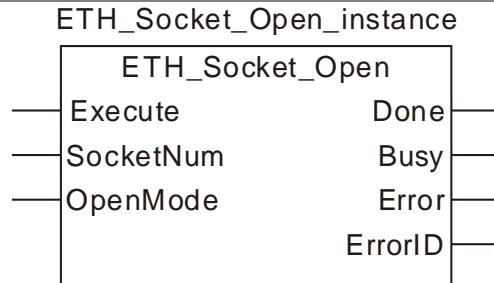

● Input Parameters

Parameter name	Function	Data type	Valid range (Default)	Validation timing
Execute	The instruction is executed when <i>Execute</i> changes from FALSE to TRUE.	BOOL	TRUE or FALSE (FALSE)	
SocketNum	Set the number of the Socket	USINT	1~8 (The variable value must be set.)	When <i>Execute</i> changes from FALSE to TRUE
OpenMode	Mode to use the controller TRUE: Client mode FALSE: Server mode	BOOL	TRUE or FALSE (FALSE)	When <i>Execute</i> changes from FALSE to TRUE

Note:

- ETH_Socket_Open is used to enable Socket. After ETH_Socket_Open is executed, the controller will try to make connection with other node or wait for other node to send out the link request.
- When *OpenMode* is TRUE, the controller is in **Client** mode. After ETH_Socket_Open instruction is executed, the controller sends out the link request to the target node. When *OpenMode* is FALSE, the controller is in **Server** mode. After ETH_Socket_Open instruction is executed, the controller waits for the link request from the target node.
- If **Socket UDP** is selected as the Socket mode, selecting TRUE or FALSE for *OpenMode* will have no impact on the use of the instruction.

● Output Parameters

Parameter name	Function	Data type	Valid range
Done	TRUE when the instruction execution is completed.	BOOL	TRUE/FALSE
Busy	TRUE when the instruction is being executed.	BOOL	TRUE/FALSE
Error	TRUE when an error occurs in execution of the instruction.	BOOL	TRUE/FALSE
ErrorID	Contains error codes when an error occurs in the instruction execution. Please refer to section 12.2 for the corresponding error code.	WORD	

■ Output Update Timing

Parameter Name	Timing for changing to TRUE	Timing for changing to FALSE
Done	◆ TRUE when the instruction execution is completed.	◆ When <i>Execute</i> changes from TRUE to FALSE.
Busy	◆ When <i>Execute</i> changes from FALSE to TRUE.	◆ When <i>Done</i> changes from FALSE to TRUE.
Error	◆ When an error occurs in the instruction execution or the input parameters for the instruction are illegal.	◆ When <i>Execute</i> changes from TRUE to FALSE.

■ **Output Update Timing Chart**

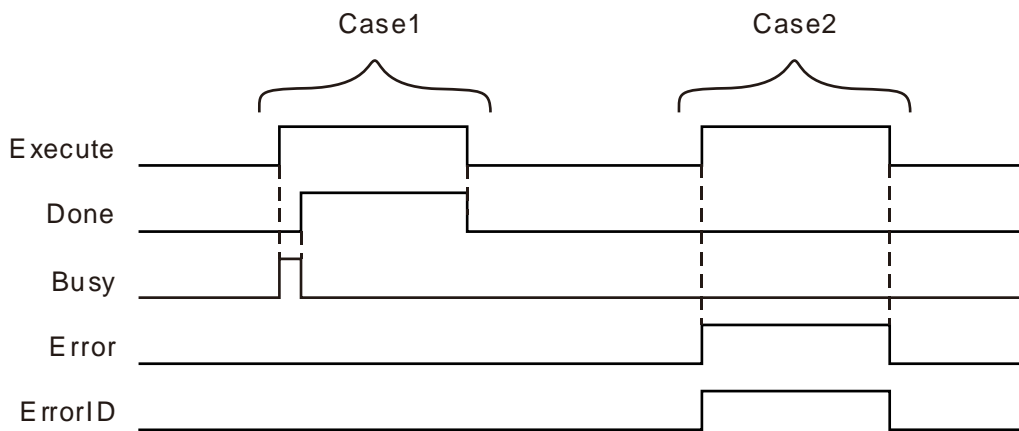

Case 1 When *Execute* changes from FALSE to TRUE, *Busy* changes to TRUE and the writing of parameters is successful. One cycle later, *Done* changes to TRUE and meanwhile *Busy* changes to FALSE. When *Execute* changes from TRUE to FALSE, *Done* changes from TRUE to FALSE.

Case 2 When *Execute* changes from FALSE to TRUE, *Error* changes to TRUE and *ErrorID* shows corresponding error code if the parameter value is illegal. When *Execute* changes to FALSE, *Error* changes to FALSE and the value in *ErrorID* changes to 0.

● **Function**

ETH_Socket_Open instruction is used for building the TCP link or enabling UDP function. The firmware of V1.02 and above supports the function.

1. ETH_Socket_Send and ETH_Socket_Receive instructions can be executed only after ETH_Socket_Open instruction is executed normally.
2. Current connection state can be checked via ETH_Socket_Status instruction after ETH_Socket_Open instruction is executed.

8.14.2.10 ETH_Socket_Send

FB/FC	Explanation	Applicable model
FB	ETH_Socket_Send is used for sending Socket data.	DVP15MC11T DVP15MC11T-06

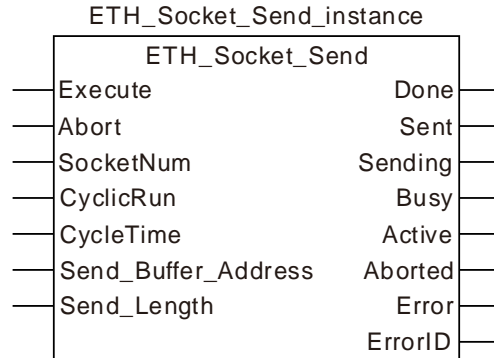

- Input Parameters

Parameter name	Function	Data type	Valid range (Default)	Validation timing
Execute	The instruction is executed when <i>Execute</i> changes from FALSE to TRUE.	BOOL	TRUE or FALSE (FALSE)	
Abort	Abort the instruction execution.	BOOL	TRUE or FALSE (FALSE)	
SocketNum	Specify the number of the Socket.	USINT	1~8 (0)	When <i>Execute</i> changes from FALSE to TRUE
CyclicRun	Set whether to cyclically send data or not. TRUE: Cyclic sending, FALSE: Only one-time data sending	BOOL	TRUE or FALSE (FALSE)	When <i>Execute</i> changes from FALSE to TRUE
CycleTime	Set the time of a cycle. Unit: ms	UINT	0~65535 (0)	When <i>Execute</i> changes from FALSE to TRUE
Send_Buffer_Address	Specify the start register for storing the sent data.	USINT	%MB0~%MB65535	When <i>Execute</i> changes from FALSE to TRUE
Send_Length	Set how many Bytes of data to be sent.	UINT	0~200 (0)	When <i>Execute</i> changes from FALSE to TRUE

Note:

The input parameter Send_Buffer_Address represents the first register address where the data the controller sends are stored, and the parameter Send_Length is the length of the data sent by the controller. The two input values must be set.

● Output Parameters

Parameter name	Function	Data type	Valid range
Done	TRUE when the one-time Socket data sending is completed in non-cyclic sending mode.	BOOL	TRUE/FALSE
Sent	TRUE when Socket data sending is completed.	BOOL	TRUE/FALSE
Sending	TRUE when Socket data are being sent.	BOOL	TRUE/FALSE
Busy	TRUE when the instruction is being executed.	BOOL	TRUE/FALSE
Active	TRUE when the instruction is controlling the controller for sending data.	BOOL	TRUE/FALSE
Aborted	TRUE when the instruction execution is aborted.	BOOL	TRUE/FALSE
Error	TRUE when an error occurs in the instruction execution.	BOOL	TRUE/FALSE
ErrorID	Contains error codes when an error occurs in the instruction execution. Please refer to section 12.2 for the corresponding error code.	WORD	

■ Output Update Timing

Parameter Name	Timing for changing to TRUE	Timing for changing to FALSE
Done	◆ When the instruction execution is finished.	◆ When <i>Execute</i> changes from TRUE to FALSE.
Sent	◆ When sending one piece of Socket message is completed.	◆ When the controller starts sending another piece of data.
Sending	◆ When one piece of Socket message is being sent.	◆ When sending one piece of data is completed.
Busy	◆ When <i>Execute</i> changes to TRUE.	<ul style="list-style-type: none"> ◆ When <i>Done</i> changes from FALSE to TRUE. ◆ When <i>Aborted</i> changes from FALSE to TRUE. ◆ When <i>Error</i> changes from FALSE to TRUE.
Active	◆ When the instruction is controlling the controller for sending data.	<ul style="list-style-type: none"> ◆ When <i>Done</i> changes from FALSE to TRUE. ◆ When <i>Aborted</i> changes from FALSE to TRUE. ◆ When <i>Error</i> changes from FALSE to TRUE.
Aborted	◆ When the instruction execution is aborted.	◆ When <i>Execute</i> changes from TRUE to FALSE.
Error	◆ When an error occurs in the instruction execution or the input parameters for the instruction are illegal.	◆ When <i>Execute</i> changes from TRUE to FALSE.

■ Output Update Timing Chart

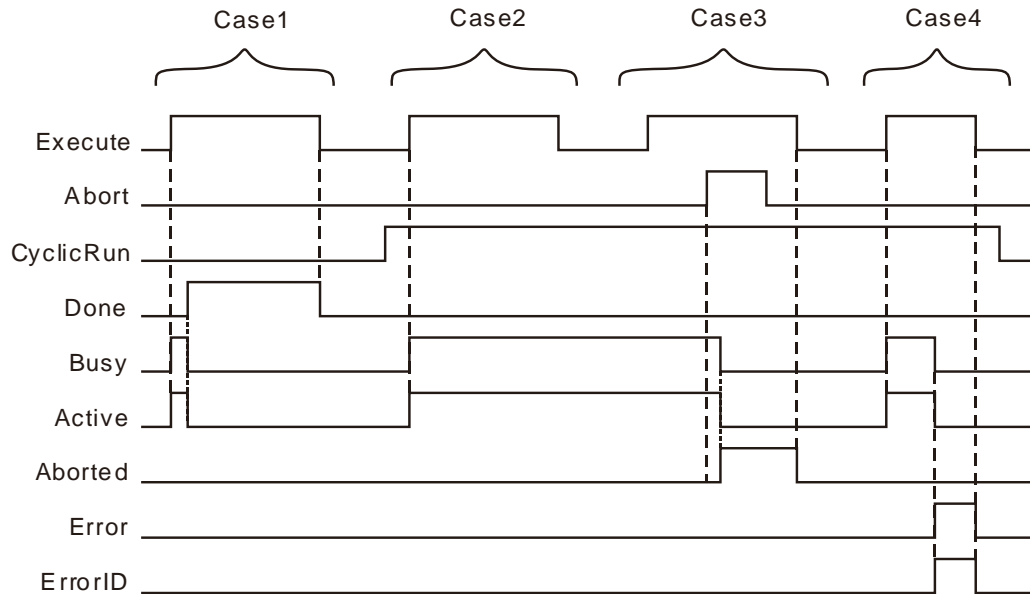

Case 1 When *Execute* changes from FALSE to TRUE, *Busy* and *Active* change to TRUE if you choose the mode to send only one piece of data. When one piece of Socket data sending is completed, *Done* changes to TRUE and meanwhile *Busy* and *Active* changes to FALSE. When *Execute* changes from TRUE to FALSE, *Done* changes to FALSE.

Case 2 When *Execute* changes from FALSE to TRUE, *Busy* and *Active* change to TRUE and the instruction starts to control the controller for sending Socket data if you choose the mode to cyclically send data. When *Execute* changes from TRUE to FALSE, the TRUE state of *Busy* and *Active* keep unchanged.

Case 3 The output state will keep unchanged by setting *Execute* from FALSE to TRUE again after case 2. By setting *Abort* from FALSE to TRUE, one cycle later, *Aborted* changes to TRUE and *Busy* and *Active* change to FALSE. When *Abort* changes from TRUE to FALSE, the output will keep unchanged. When *Execute* changes from TRUE to FALSE, *Aborted* changes to FALSE.

Case 4 When *Execute* changes from FALSE to TRUE, *Busy* and *Active* change to TRUE. When an error occurs in the instruction execution, *Error* changes to TRUE and the value in *ErrorID* shows corresponding error code and meanwhile *Busy* and *Active* change to FALSE. When *Execute* changes from TRUE to FALSE, *Error* changes to FALSE and the value in *ErrorID* changes to 0.

● Function

ETH_Socket_Send is used for sending Socket data. The firmware of V1.02 and above supports the function.

1. The input parameter *CyclicRun* sets whether to cyclically send data or not and *CycleTime* value is the time of a cycle. When *CyclicRun* is TRUE and ETH_Socket_Send instruction is executed, the controller sends a piece of data every a period of time which is the value of *CycleTime*. When *CyclicRun* is FALSE and ETH_Socket_Send instruction is executed, the controller only sends out one piece of data.
2. When the value of *CycleTime* is 0 and *CyclicRun* is TRUE, the controller still sends data cyclically without any limit in time interval.
3. If the input parameter value is changed and then the instruction is retrigged during the instruction

execution, the new input parameter value will not be effective. You have to use the input parameter *Abort* to abort the instruction first, then re-execute the instruction and then the new input parameter value will take effect.

4. The value of *Send_Length* can not be set to 0. Otherwise, an error will occur in the instruction execution.

8.14.2.11 ETH_Socket_Receive

FB/FC	Explanation	Applicable model
FB	ETH_Socket_Receive is used for receiving Socket data.	DVP15MC11T DVP15MC11T-06

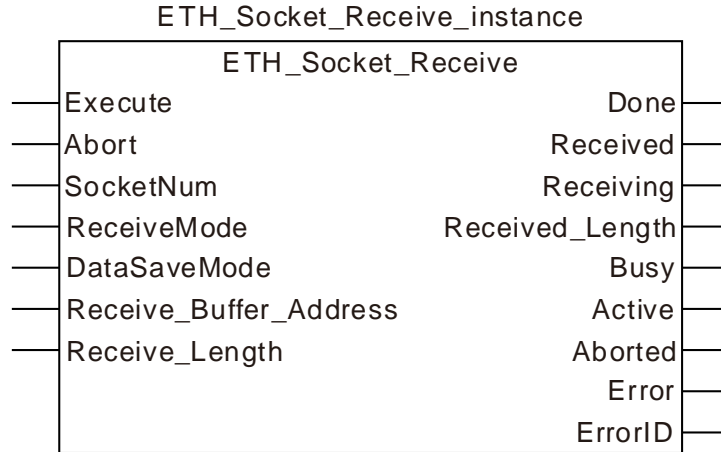

- Input Parameters

Parameter name	Function	Data type	Valid range (Default)	Validation timing
Execute	The instruction is executed when <i>Execute</i> changes from FALSE to TRUE.	BOOL	TRUE or FALSE (FALSE)	
Abort	Abort the instruction execution.	BOOL	TRUE or FALSE (FALSE)	
SocketNum	Specify the number of the Socket.	USINT	1~8 (0)	When <i>Execute</i> changes from FALSE to TRUE
ReceiveMode	Set the mode to receive data. 0: Keep receiving data 1: Only receive one piece of data	USINT	0, 1 (0)	When <i>Execute</i> changes from FALSE to TRUE
DataSaveMode	Set the mode to save data. 0: Splicing 1: Covering	USINT	0, 1 (0)	When <i>Execute</i> changes from FALSE to TRUE
Receive_Buffer_Address	Specify the start register for storing the received data.	USINT	%MB0~%MB65535	When <i>Execute</i> changes from FALSE to TRUE
Receive_Length	Set how many Bytes of data to be received.	UINT	0~200 (200)	When <i>Execute</i> changes from FALSE to TRUE

Note:

The input parameter **Receive_Buffer_Address** represents the first register address where the data the controller receives are stored, and the parameter **Receive_Length** is the length of the data received by the controller. The two input values must be set.

- **Output Parameters**

Parameter name	Function	Data type	Valid range
Done	TRUE when the one-time socket data receiving is complete in the only-one-time data receiving mode.	BOOL	TRUE/FALSE
Received	TRUE when Socket data receiving is completed.	BOOL	TRUE/FALSE
Receiving	TRUE when Socket data are being received.	BOOL	TRUE/FALSE
Received_Length	The size of the data which are actually received.	UINT	
Busy	TRUE when the instruction is being executed.	BOOL	TRUE/FALSE
Active	TRUE when the instruction is controlling the controller for receiving data.	BOOL	TRUE/FALSE
Aborted	TRUE when the instruction execution is aborted.	BOOL	TRUE/FALSE
Error	TRUE when an error occurs in the instruction execution.	BOOL	TRUE/FALSE
ErrorID	Contains error codes when an error occurs in the instruction execution. Please refer to section 12.2 for the corresponding error code.	WORD	

- **Output Update Timing**

Parameter Name	Timing for changing to TRUE	Timing for changing to FALSE
Done	◆ When the instruction execution is completed.	◆ When <i>Execute</i> changes from TRUE to FALSE.
Received	◆ When one piece of Socket data receiving is completed.	◆ When <i>Execute</i> changes from TRUE to FALSE. ◆ When the instruction starts receiving the next piece of data.
Receiving	◆ While one piece of Socket data is being received.	◆ When one piece of Socket data receiving is completed.
Busy	◆ When <i>Execute</i> changes to TRUE.	◆ When <i>Done</i> changes from FALSE to TRUE; ◆ When the instruction execution is aborted; ◆ When <i>Error</i> changes from FALSE to TRUE.
Active	◆ When the instruction is controlling the controller for receiving data.	◆ When <i>Done</i> changes from FALSE to TRUE. ◆ When the instruction execution is aborted.

Parameter Name	Timing for changing to TRUE	Timing for changing to FALSE
		◆ When <i>Error</i> changes from FALSE to TRUE.
Aborted	◆ When the instruction execution is aborted.	◆ When <i>Execute</i> changes from TRUE to FALSE.
Error	◆ When an error occurs in the instruction execution or the input parameters for the instruction are illegal.	◆ When <i>Execute</i> changes from TRUE to FALSE.

■ Output Update Timing Chart

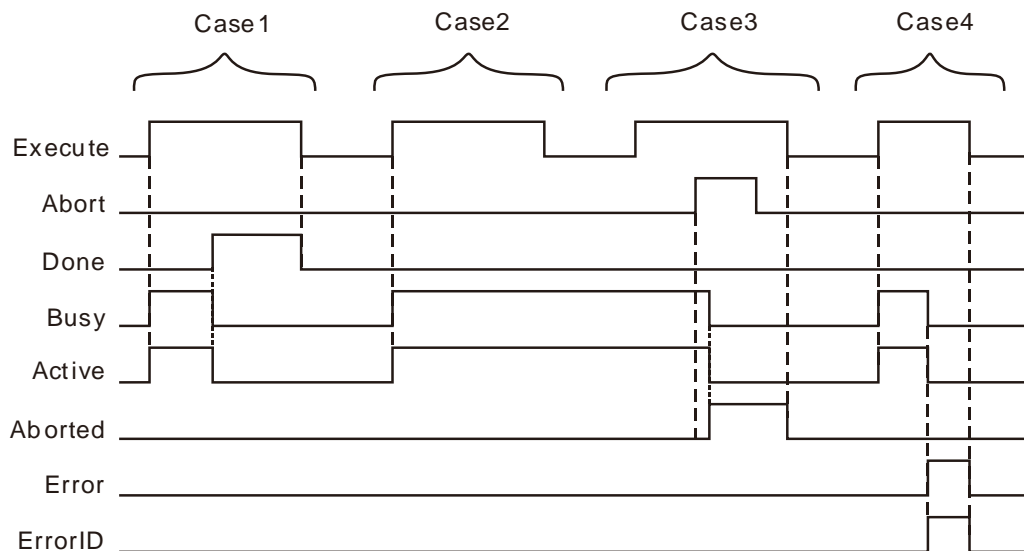

- Case 1** If the instruction is used to receive one message or constantly receive multiple messages by setting the value of *DataSaveMode* to 0, *Busy* and *Active* both change to TRUE when *Execute* changes from FALSE to TRUE. *Done* changes to TRUE and both *Busy* and *Active* change to FALSE when a piece of data receiving is finished or the total length of spliced data reaches or exceeds the set length. *Done* changes to FALSE when *Execute* changes from TRUE to FALSE.
- Case 2** If the value of *DataSaveMode* is set to 1, *Busy* and *Active* change to TRUE as *Execute* changes from FALSE to TRUE. And the state of *Busy* and *Active* both keep unchanged and the instruction keep receiving data as *Execute* changes from TRUE to FALSE.
- Case 3** *Execute* is set from FALSE to TRUE again after case 2 and the output state of the instruction keeps unchanged. Set *Abort* from FALSE to TRUE. One cycle later, *Aborted* changes from FALSE to TRUE and meanwhile *Busy* and *Active* change to FALSE. When *Abort* changes from TRUE to FALSE, the output of the instruction keeps unchanged. When *Execute* changes from TRUE to FALSE, *Aborted* changes to FALSE.
- Case 4** When *Execute* changes from FALSE to TRUE, *Busy* and *Active* change to TRUE. When an error occurs, *Error* changes to TRUE, *ErrorID* shows corresponding error code and meanwhile *Busy* and *Active* change to FALSE. When *Execute* changes from TRUE to FALSE, *Error* changes to FALSE and the value of *ErrorID* changes to 0.

● **Function**

ETH_Socket_Receive is used for receiving Socket data. The firmware of V1.02 and above supports the function.

1. When the value of *ReceiveMode* is set to 0, the controller can constantly receive Socket data. When the value of *DataSaveMode* is set to 0, the instruction has the received data stored in the registers starting from the start register specified by *Receive_Buffer_Address* in the mode of splicing. The controller stores new data in the registers following where the last data are stored. When the total length of received data is greater than the value of *Receive_Length*, the output *Done* changes to TRUE and the instruction execution is finished.
2. When the value of input parameter *ReceiveMode* is 0 and *DataSaveMode* is 1, the instruction has the received data stored in the registers starting from the start register specified by *Receive_Buffer_Address* in the mode of covering. Every time the controller has the received data stored in the registers starting from the start register specified by *Receive_Buffer_Address*.
3. When the length of the first piece of data received exceeds the length specified by *Receive_Length*, the controller writes the data of the length specified by *Receive_Length* to the specified device first, the data beyond the set length are discarded, and then the instruction reports an error.
4. In the process of instruction execution, modify the input parameter value of the instruction, then trigger the instruction execution, the new input parameter value will not take effect. The instruction must be interrupted by using the input parameter *Abort*, then the new input parameter value will take effect as the instruction is re-executed.

8.14.2.12 ETH_Socket_Close

FB/FC	Explanation	Applicable model
FB	ETH_Socket_Close is used for disabling Socket.	DVP15MC11T DVP15MC11T-06

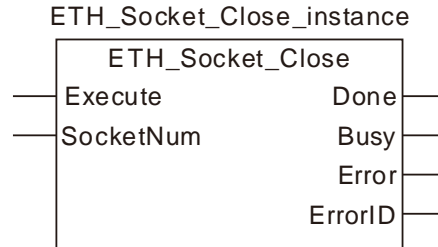

- Input Parameters

Parameter name	Function	Data type	Valid range (Default)	Validation timing
Execute	The instruction is executed as <i>Execute</i> changes from FALSE to TRUE.	BOOL	TRUE or FALSE (FALSE)	
SocketNum	Specify the number of the Socket.	USINT	1~8 (0)	When <i>Execute</i> changes from FALSE to TRUE

Note: The TCP link and UDP function can be disabled through ETH_Socket_Close.

- Output Update Timing

Parameter name	Function	Data type	Valid range
Done	TRUE when the instruction execution is completed.	BOOL	TRUE/FALSE
Busy	TRUE when the instruction is being executed.	BOOL	TRUE/FALSE
Error	TRUE when an error occurs in the instruction execution.	BOOL	TRUE/FALSE
ErrorID	Contains error codes when an error occurs in the instruction execution. Please refer to section 12.2 for the corresponding error code.	WORD	

- Output Update Timing

Parameter Name	Timing for changing to TRUE	Timing for changing to FALSE
Done	◆ When the instruction execution is finished.	◆ When <i>Execute</i> changes from TRUE to FALSE.
Busy	◆ When <i>Execute</i> changes from FALSE to TRUE.	◆ When <i>Done</i> changes from TRUE to FALSE.
Error	◆ When an error occurs in the instruction execution or the input parameters for the instruction are illegal.	◆ When <i>Execute</i> changes from TRUE to FALSE.

● **Output Update Timing**

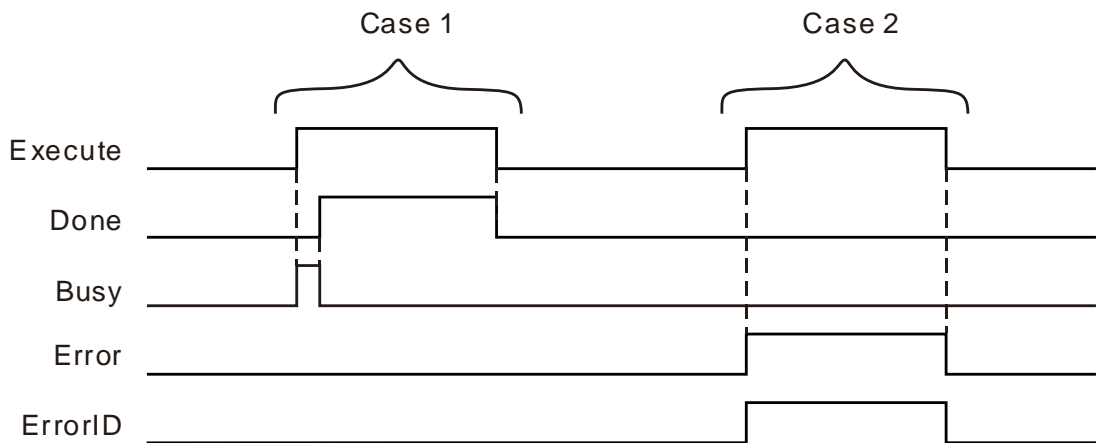

Case 1 : When *Execute* changes from FALSE to TRUE, *Busy* changes to TRUE and parameter values writing succeeds. One cycle later, *Done* changes to TRUE and meanwhile *Busy* changes to FALSE. When *Execute* changes from TRUE to FALSE, *Done* changes from TRUE to FALSE.

Case 2 : When *Execute* changes from FALSE to TRUE, *Error* changes to TRUE and *ErrorID* shows corresponding error code if the written parameter value is illegal. When *Execute* changes to FALSE, *Error* changes to FALSE and the value in *ErrorID* changes to 0.

● **Function**

ETH_Socket_Close is used for disconnecting the TCP link or disabling UDP function. The firmware of V1.02 and above supports the function.

8.14.2.13 ETH_Socket_Status

FB/FC	Explanation	Applicable model
FB	ETH_Socket_Status is used for reading current state of the specified Socket.	DVP15MC11T DVP15MC11T-06

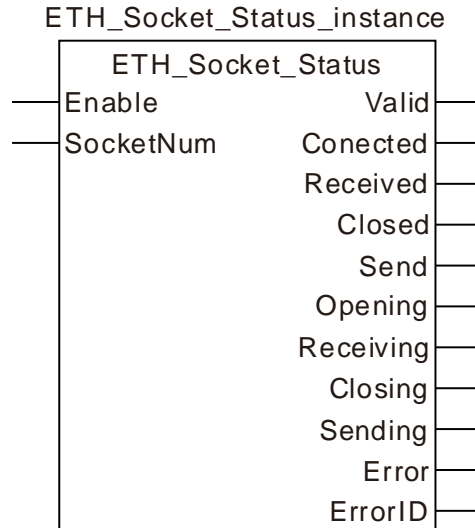

- Input Parameters

Parameter name	Function	Data type	Valid range (Default)	Validation timing
Enable	The instruction is executed as <i>Enable</i> changes to TRUE.	BOOL	TRUE or FALSE (FALSE)	
SocketNum	The number of the Socket to be monitored.	UINT	1~8 (0)	When <i>Enable</i> changes to TRUE

Note: Current state of the Socket of the specified number and the occurrence of any error can be monitored through ETH_Socket_Status instruction.

- Output Update Timing

Parameter name	Function	Data type	Valid range
Valid	TRUE when Socket data sending and receiving are both completed.	BOOL	TRUE/FALSE
Connected	TRUE when the connection to the target device is successful.	BOOL	TRUE/FALSE
Received	TRUE when data receiving is successful.	BOOL	TRUE/FALSE
Closed	TRUE when the link has been closed.	BOOL	TRUE/FALSE
Send	TRUE when data have been sent.	BOOL	TRUE/FALSE
Opening	TRUE when the link to the target device is being conducted.	BOOL	TRUE/FALSE
Receiving	TRUE when data are being received.	BOOL	TRUE/FALSE
Closing	TRUE when current link is being closed.	BOOL	TRUE/FALSE
Sending	TRUE when a timeout occurs in data sending or receiving.	BOOL	TRUE/FALSE
Error	TRUE when an error occurs in the instruction execution.	BOOL	TRUE/FALSE
ErrorID	Contains error codes when an error occurs in the instruction execution. Please refer to section 12.2 for the corresponding error code.	WORD	

● **Output Update Timing**

Parameter Name	Timing for changing to TRUE	Timing for changing to FALSE
Valid	◆ When <i>Enable</i> changes from FALSE to TRUE.	◆ When <i>Enable</i> changes from TRUE to FALSE.
Connected	◆ When Socket link is finished.	◆ When <i>Enable</i> changes from TRUE to FALSE. ◆ When <i>Closing</i> changes from FALSE to TRUE.
Received	◆ When a piece of message receiving is completed.	◆ When <i>Receiving</i> changes from FALSE to TRUE. ◆ When <i>Enable</i> changes from TRUE to FALSE.
Closed	◆ When Socket link is closed.	◆ When <i>Enable</i> changes from TRUE to FALSE. ◆ When <i>Opening</i> changes from FALSE to TRUE.
Send	◆ When a piece of message sending is completed.	◆ When <i>Enable</i> changes from TRUE to FALSE. ◆ When <i>Sending</i> changes from TRUE to FALSE.
Opening	◆ When the controller starts to build the Socket link or is waiting to be linked to.	◆ When <i>Enable</i> changes from TRUE to FALSE. ◆ When <i>Connected</i> changes from FALSE to TRUE.
Receiving	◆ When the controller is receiving a piece of message.	◆ When <i>Enable</i> changes from TRUE to FALSE. ◆ When <i>Received</i> changes from FALSE to TRUE.
Closing	◆ When Socket is disabled	◆ When <i>Enable</i> changes from TRUE to FALSE. ◆ When <i>Closed</i> changes from FALSE to TRUE.
Sending	◆ When a piece of message is being sent.	◆ When <i>Enable</i> changes from TRUE to FALSE.
Error	◆ When an instruction execution error or Socket error occurs.	◆ When <i>Enable</i> changes from TRUE to FALSE.

- **Output Update Timing**

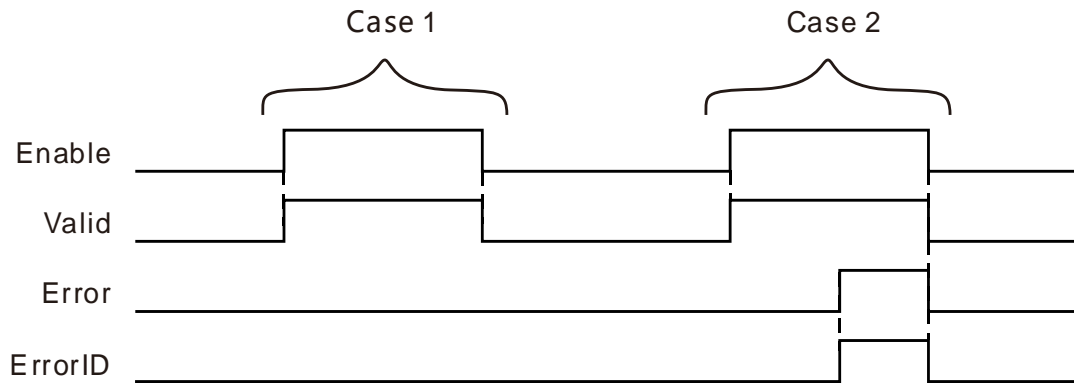

Case 1 : When *Enable* changes from FALSE to TRUE, *Valid* changes to TRUE. When *Enable* changes from TRUE to FALSE, *Valid* changes to FALSE.

Case 2 : When *Enable* changes from FALSE to TRUE, *Valid* changes to TRUE. When an error occurs in the instruction execution, *Error* changes to TRUE and *ErrorID* shows error codes and *Valid* keeps the state of TRUE. When *Enable* changes from TRUE to FALSE, *Valid* and *Error* both change to FALSE and the value in *ErrorID* changes to 0.

- **Function**

ETH_Socket_Status is used for monitoring current state of the Socket of the specified number. The firmware of V1.02 and above supports the function.

8.14.2.14 Ethernet Free Protocol Example



Programming Example

■ Example of how to use ETH_Socket_Config instruction:

➤ Variable table and the program

Variable name	Address	Data type	Initial value
TEST_BEGIN		BOOL	
ETH_Socket_Manage0		ETH_Socket_Manage	
M_En		BOOL	
M_SEN		BOOL	
M_Valid		BOOL	
M_SR		BOOL	
M_LErr		BOOL	
ETH_Socket_Config0		ETH_Socket_Config	
CON_Ex		BOOL	
CON_PType		USINT	1
CON_IP1		USINT	192
CON_IP2		USINT	168
CON_IP3		USINT	1
CON_IP4		USINT	10
CON_RP		UINT	502
CON_LP		UINT	502
CON_KT		UINT	30
CON_Done		BOOL	
CON_Bsy		BOOL	
CON_Err		BOOL	
CON_ErrID		WORD	
ETH_Socket_Open0		ETH_Socket_Open	
O_Ex		BOOL	
O_SMode		BOOL	TRUE
O_Done		BOOL	
O_Bsy		BOOL	
O_Err		BOOL	
O_ErrID		WORD	
ETH_Socket_Send0		ETH_Socket_Send	
S_Ex		BOOL	
S_Abort		BOOL	
S_CR		BOOL	TRUE
S_CT		UINT	100

Variable name	Address	Data type	Initial value
S_BFA	%MB200	USINT	
S_LTH		UINT	17
S_Done		BOOL	
S_Sent		BOOL	
S_Sending		BOOL	
S_Bsy		BOOL	
S_Act		BOOL	
S_Abt		BOOL	
S_Err		BOOL	
S_ErrID		WORD	
ETH_Socket_Receive0		ETH_Socket_Receive	
R_Ex		BOOL	
R_Abort		BOOL	
R_Mode		USINT	0
R_SMode		USINT	1
R_BFA	%MB600	USINT	
R_LTH		UINT	100
R_Done		BOOL	
R_RECD		BOOL	
R_RING		BOOL	
R_RLTH		BOOL	
R_Bsy		BOOL	
R_Act		BOOL	
R_Abt		BOOL	
R_Err		BOOL	
R_ErrID		WORD	
ETH_Socket_Close0		ETH_Socket_Close	
C_Ex		BOOL	
C_Done		BOOL	
C_Bsy		BOOL	
C_Err		BOOL	
C_ErrID		WORD	
ETH_Socket_Status0		ETH_Socket_Status	
STA_En		BOOL	TRUE
STA_Valid		BOOL	
STA_CON		BOOL	
STA_REC		BOOL	
STA_CLO		BOOL	

Variable name	Address	Data type	Initial value
STA_Send		BOOL	
STA_OING		BOOL	
STA_RING		BOOL	
STA_CING		BOOL	
STA_SING		BOOL	
STA_Err		BOOL	
STA_ErrID		WORD	

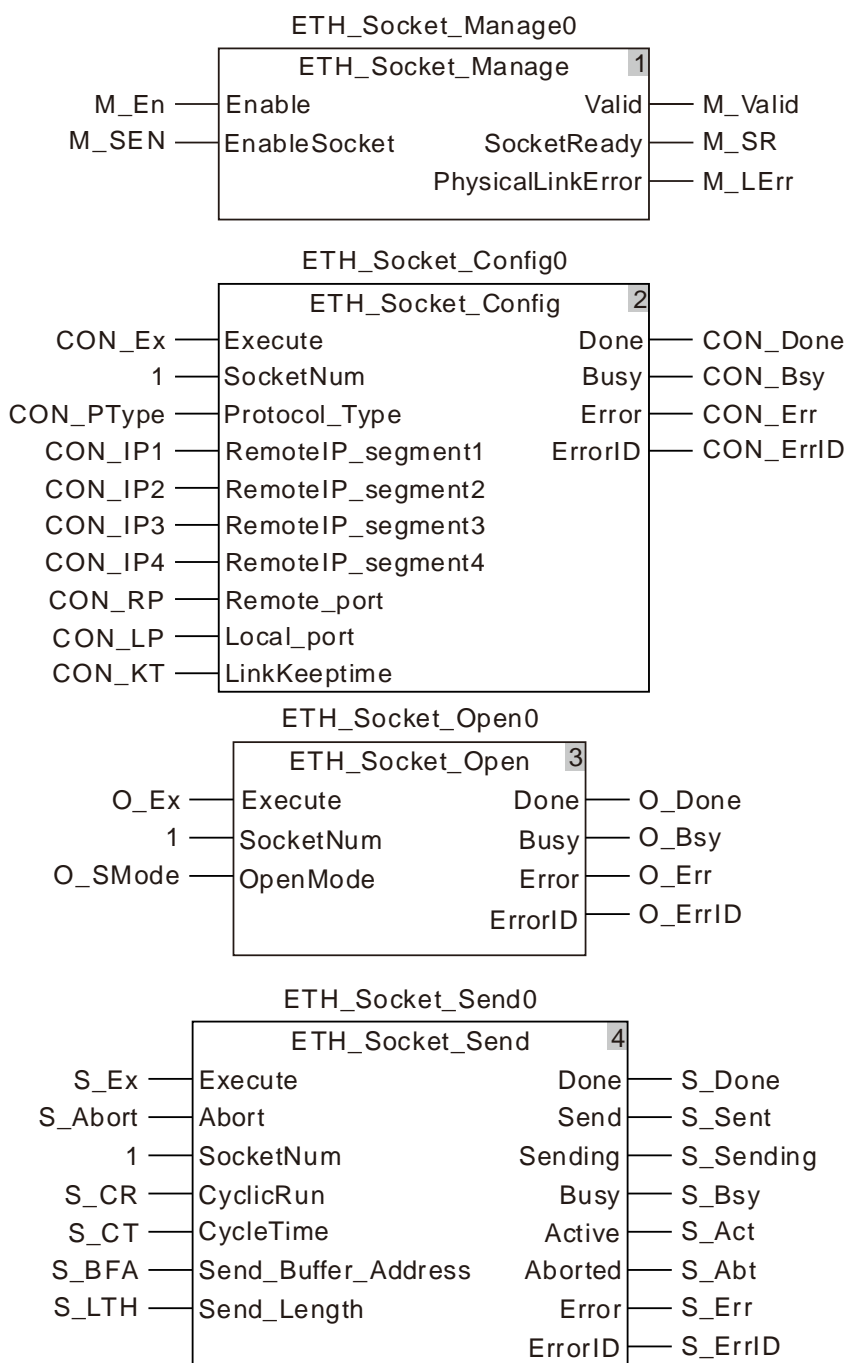

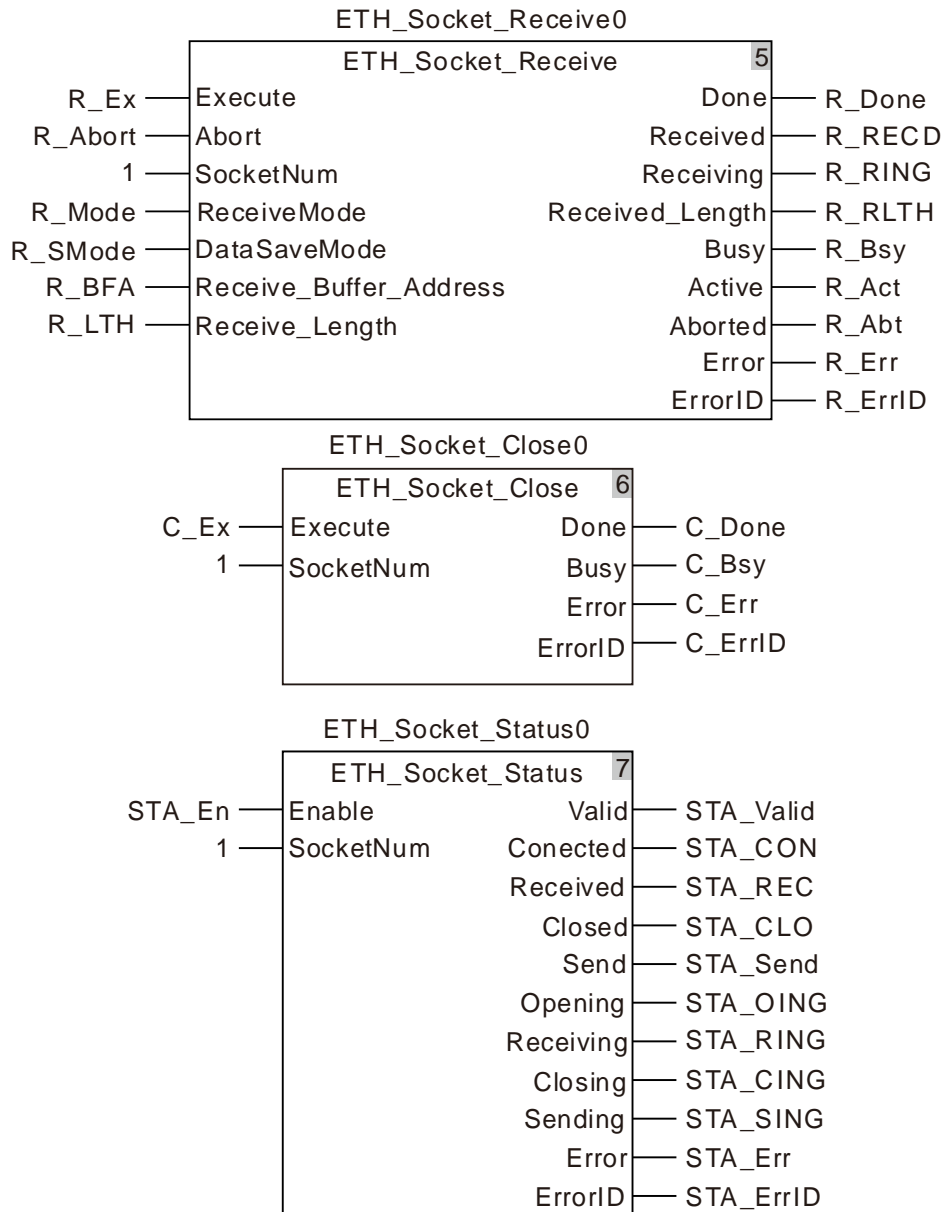

■ Operation steps and data exchange description

1. The variables S_BFA and R_BFA are respectively bound to the addresses %MB200 and %MB600. After the program compiling is successful and download is completed, the online is performed. After the online is activated, the standard MODBUS TCP data "00 00 00 00 00 0b 00 10 10 00 00 02 04 aa bb cc dd" are written to 17 consecutive %MB registers starting from %MB200.
2. Execute ETH_Socket_Manage instruction first by setting *M_En* to TRUE and then setting *M_SEN* to TRUE. After *M_SR* variable changes to TRUE, execute ETH_Socket_Config by setting *CON_Ex* variable to TRUE.
3. After the execution of ETH_Socket_Config instruction is completed, execute ETH_Socket_Open instruction by setting *O_Ex* to TRUE. The controller starts to build the link to the target host. Current connection state can be known by checking the output of ETH_Socket_Status instruction.

4. After the controller builds the link to the target successfully, the output *Connected* of `ETH_Socket_Status` changes to TRUE. Then execute `ETH_Socket_Send` by setting `S_Ex` to TRUE. The controller will cyclically send 17 bytes of data in the registers starting from `%MB200` to the target host.
5. Execute `ETH_Socket_Receive` to receive the data that the target host returns or sends to the controller. The controller will receive and store the data constantly in the mode of covering in this example.
6. `ETH_Socket_Close` instruction is used to disable current link. After `C_Ex` is set to TRUE, the controller will disconnect the link and stop sending and receiving data.

8.14.3 RS485 Communication Instructions

8.14.3.1 RS485_Link_Manage

FB/FC	Explanation	Applicable model
FB	RS485_Link_Manage is used for switching on or off RS485 communication.	DVP15MC11T DVP15MC11T-06

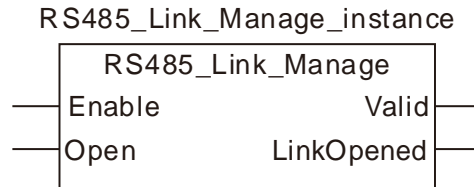

● Input Parameters

Parameter name	Function	Data type	Valid range (Default)	Validation timing
Enable	The instruction is executed when <i>Enable</i> changes from FALSE to TRUE.	BOOL	TRUE or FALSE (FALSE)	-
Open	The 485 communication is switched on or off.	BOOL	TRUE or FALSE (FALSE)	When <i>Enable</i> changes from FALSE to TRUE

● Output Parameters

Parameter name	Function	Data type	Valid range
Valid	TRUE when the outputs of the instruction are valid.	BOOL	TRUE / FALSE
LinkOpened	TRUE when 485 communication is enabled.	BOOL	TRUE / FALSE

● Output Update Timing

Parameter Name	Timing for changing to TRUE	Timing for changing to FALSE
Valid	◆ When <i>Enable</i> changes to TRUE.	◆ When <i>Enable</i> changes from TRUE to FALSE.
LinkOpened	◆ When <i>Enable</i> changes to TRUE, <i>Open</i> changes to TRUE.	◆ When <i>Enable</i> changes from TRUE to FALSE. ◆ When <i>Open</i> changes from TRUE to FALSE.

● Output Update Timing Chart

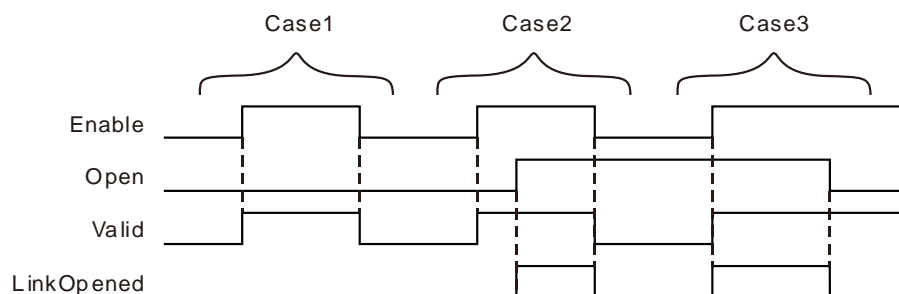

Case 1 : When *Enable* changes from FALSE to TRUE, *Open* changes to FALSE, *Valid* changes to TRUE and *LinkOpened* changes to FALSE.

Case 2 : As *Enable* changes from FALSE to TRUE, *Valid* changes to TRUE. In this case, *LinkOpened*

changes to TRUE as *Open* changes from FALSE to TRUE. When *Enable* changes from TRUE to FALSE, *Valid* and *LinkOpened* change to FALSE.

Case 3 : As *Open* is TRUE and *Enable* changes from FALSE to TRUE, *Valid* and *LinkOpened* change to TRUE. As *Open* changes to FALSE, *LinkOpened* changes to FALSE.

● **Function:**

RS485_Link_Manage is used to enable or disable the RS485 communication. The firmware of V1.01 and above supports the function.

1. The input *Enable* is used to control the instruction to take effect or not. When *Enable* changes to FALSE, the operation of other parameters of the instruction will be invalid. When *Enable* changes to TRUE, the instruction will take effect and then the operation of other parameter of the instruction will be valid.
2. In the case that *Enable* is TRUE, the RS485 communication is switched on as *Open* changes to TRUE. The RS485 communication is switched off as *Open* is FALSE.
3. Before the RS485 communication function is switched on, the parameters of the RS485_Link_Config instruction must have been configured. Otherwise, the configured parameters will be not effective if the RS485 function is switched on before the parameters of the RS485_Link_Config instruction are configured, unless the RS485 communication function is re-switched on.
4. After multiple *LinkNum* parameters are configured through RS485_Link_Config instructions, only one RS485_Link_Manage instruction is enough to switch on the RS485 communication function. And all configurations specified by RS485_Link_Config instructions are for the exchange data with the slave.

8.14.3.2 RS485_Link_Config

FB/FC	Explanation	Applicable model
FB	RS485_Link_Config is used for configuration of 485 communication parameters of the motion controller.	DVP15MC11T DVP15MC11T-06

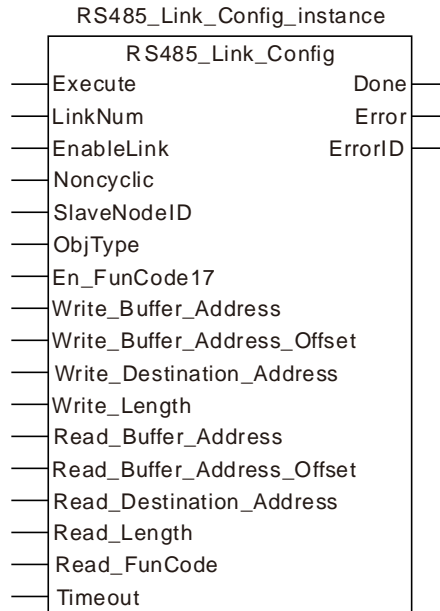

● Input Parameters

Parameter name	Function	Data type	Valid range (Default)	Validation timing
Execute	The instruction is executed when <i>Execute</i> changes from FALSE to TRUE.	BOOL	TRUE or FALSE (FALSE)	
LinkNum	Specify the number of the Link.	UINT	1~24 (The variable value must be set)	When <i>Execute</i> changes from FALSE to TRUE
EnableLink	Enable or disable the Link.	BOOL	TRUE or FALSE (FALSE)	When <i>Execute</i> changes from FALSE to TRUE
Noncyclic	Set the Link communication mode FALSE: Cyclic, TRUE: Non-cyclic	BOOL	TRUE or FALSE (FALSE)	When <i>Execute</i> changes from FALSE to TRUE
SlaveNodeID	Specify the node ID of the 485 slave.	USINT	0~255 (0)	When <i>Execute</i> changes from FALSE to TRUE
ObjType	Set the type of the slave register to be read and written 0: Word register 1: Bit register	USINT	0~1 (0)	When <i>Execute</i> changes from FALSE to TRUE
En_FunCode17	Set the function code 17 to be used or not.	BOOL	TRUE or FALSE (FALSE)	When <i>Execute</i> changes from FALSE to TRUE
Write_Buffer_Address	The starting register of the master where the sent data are stored	UINT	%MW0 ~ %MW32767 %QW0 ~ %QW63	When <i>Execute</i> changes from FALSE to TRUE
Write_Buffer_A	Set the offset of the starting	USINT	0~255	When <i>Execute</i>

Parameter name	Function	Data type	Valid range (Default)	Validation timing
address_Offset	register of the master sending data. The setting value 1 means the offset is 1 word if data are written to the word address of the slave. The setting value 1 means the offset is 1 bit if data are written to the bit address of the slave.		(0)	changes from FALSE to TRUE
Write_Destination_Address	The starting address of the MODBUS slave receiving the data from the master	UINT	Standard Modbus address	When <i>Execute</i> changes from FALSE to TRUE
Write_Length	The length of data to be written	UINT	Word register: 0~100 Bit register: 0~256	When <i>Execute</i> changes from FALSE to TRUE
Read_Buffer_Address	The starting register of the master where data received are stored.	UINT	%MW0~%MW327 67 %QW0~%QW63	When <i>Execute</i> changes from FALSE to TRUE
Read_Buffer_Address_Offset	Set the offset of the starting register of the master receiving data. The setting value 1 means the offset is 1 word if the word register of the slave is read. The setting value 1 means the offset is 1 bit if the bit register of the slave is read.	USINT	0~255 (0)	When <i>Execute</i> changes from FALSE to TRUE
Read_Destination_Address	Set the starting address of the MODBUS slave to be read by the master.	UINT	Standard Modbus address	When <i>Execute</i> changes from FALSE to TRUE
Read_Length	The length of data to be read	UINT	Word register: 0~100 Bit register: 0~256	When <i>Execute</i> changes from FALSE to TRUE
Read_FunCode	Select the function code for reading Bit address.	USINT	1: function code 01 2: function code 02 (2)	When <i>Execute</i> changes from FALSE to TRUE
Timeout	Set the time for the master to wait for the slave's response. The slave timeout occurs if the slave does not respond to the master request within the set time. Unit: ms	UINT	An integer greater than 0 (300)	When <i>Execute</i> changes from FALSE to TRUE

● **Output Parameters**

Parameter name	Function	Data type	Valid range
Done	TRUE When the configuration of Link parameters is successful.	BOOL	TRUE / FALSE
Error	TRUE when an error occurs in execution of the instruction.	BOOL	TRUE / FALSE
Error ID	Contains the error code when an error occurs. Please refer to section 12.2 for the corresponding error ID.	WORD	

● **Output Update Timing**

Parameter Name	Timing for changing to TRUE	Timing for changing to FALSE
Done	◆ When the configuration of parameters is correct and <i>Execute</i> changes from FALSE to TRUE.	◆ When <i>Execute</i> changes from TRUE to FALSE.
Error	◆ When the configuration of parameters is incorrect and <i>Execute</i> changes from FALSE to TRUE.	◆ When <i>Execute</i> changes from TRUE to FALSE. ◆ When <i>Execute</i> is re-triggered after the parameter configuration is modified correctly.

● Output Update Timing Chart

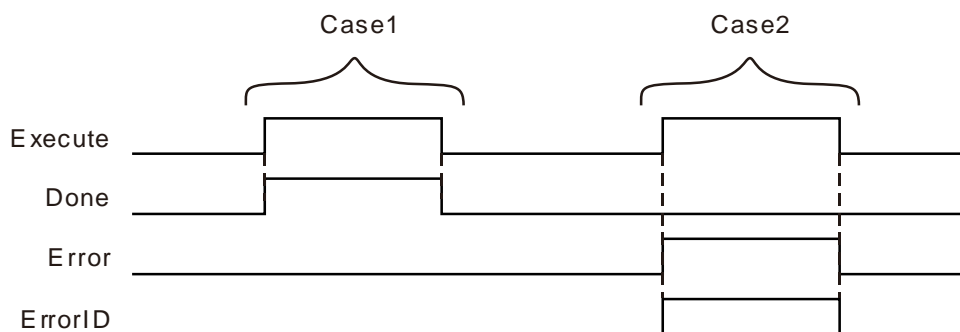

Case 1 : If the configuration of parameters is correct, *Done* changes from FALSE to TRUE as *Execute* changes from FALSE to TRUE.

Case 2 : If an error occurs in the configuration of parameters, *Done* is FALSE and *Error* changes from FALSE to TRUE as *Execute* changes from FALSE to TRUE.

● Function

RS485_Link_Config is used to configure parameters for 485 communication Link. The firmware of V1.01 and above supports the function.

● Precaution

1. *ObjType* is the data type of the read and written parameter. When *ObjType* is 0, it means to read and write the word register of the slave. The range of *Write_Length* and *Read_Length* is 0~100 and the values of *Write_Length* and *Read_Length* can not be 0 at the same time.

When *ObjType* is 1, it means to read and write the bit register of the slave. The range of *Write_Length* and *Read_Length* is 0~256 and the values of *Write_Length* and *Read_Length* can not be 0 at the same time. For local addresses, you can directly fill addresses, variables combined with addresses, arrays combined with the starting addresses.

- For local address to fill the %MB address, you can only fill the low byte of the %MW address rather than the high byte.
- For the register address of the slave, you can directly fill the MODBUS address and variable.
- For the offset in the word operation, the actual address is calculated by word. For the offset in the bit operation, the actual address is calculated by bit.

For example:

- ◆ Actual address calculated via word offset :

When the address is %MW0 and the offset is 15, the actual operation address is %MW15=%MW (0+15).

- ◆ Actual address calculated via bit offset:

When the address is %QW0 and the offset is 7, the actual operation address is %QX0.7.

- If you choose to read and write the word register of the slave, the %MW register of the local device can be regarded as the storage register for reading and writing data. The range of the storage register is %MW0~%MW32767. If the range is exceeded or other register is used, an error will occur in the instruction.

6. If you choose to read and write the bit register of the slave, the %MW and %QW registers of the local device can be regarded as the storage registers for reading and writing data. The ranges of the storage register are %MW0~%MW32767 and %QW0~%QW63. If the ranges are exceeded or other register is used, an error will occur in the instruction.
7. The set parameter values of this instruction are only valid during the operation of the PLC. When the motion controller is repowered after power off, the parameters configured before the power off are all invalidated. The ETH_Link_Config instruction must be re-executed if the configuration before the power off is needed to use.
8. When the bit registers of the slave are read, the value of Read_FunCode must be set to 01 or 02. You can select the function code according to the type of the bit register through referring to the corresponding module manual.
9. Set the communication mode via the input parameter *Noncyclic*. The communication mode is the cyclic communication mode if *Noncyclic* is set to FALSE. The communication mode is the non-cyclic communication mode if *Noncyclic* is set to TRUE.
 - a. Cyclic Communication Mode: When the current Link is set as cyclic communication mode. The configuration for the Link will be effective immediately and the data exchange between the master and slave will be conducted cyclically after RS485 communication function is enabled via RS485_Link_Manage instruction.
The configuration for the link will not be executed and the data exchange with the slave will stop after RS485 communication function is disabled via RS485_Link_Manage instruction.
 - b. Non-Cyclic Communication Mode: When the current Link is set as non-cyclic communication mode. The configuration for the Link will be effective immediately and the data exchange between the master and slave will be conducted only once after RS485 communication function is enabled via RS485_Link_Manage instruction.
If the data exchange between the master and the slave is to be made once again, re-enable RS485 communication function after RS485 communication function is disabled via RS485_Link_Manage instruction.

8.14.3.3 RS485_Link_Status

FB/FC	Explanation	Applicable model
FB	RS485_Link_Status is used to watch if an error occurs in the 485 link which the number corresponds to or if the slave replies with error codes.	DVP15MC11T DVP15MC11T-06

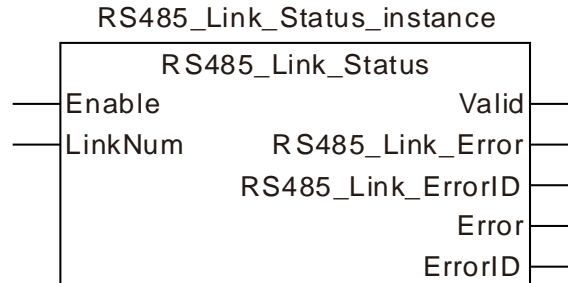

● Input Parameters

Parameter name	Function	Data type	Valid range (Default)	Validation timing
Enable	The instruction is validated when <i>Enable</i> changes from FALSE to TRUE.	BOOL	TRUE or FALSE (FALSE)	
LinkNum	The number of the link to be watched.	UINT	1~24 (The variable value must be set)	When <i>Enable</i> changes from FALSE to TRUE

● Output Parameters

Parameter name	Function	Data type	Valid range
Valid	TRUE when the outputs of the instruction are valid.	BOOL	TRUE / FALSE
RS485_Link_Error	TRUE when an error occurs in the corresponding link. It is valid when <i>Error</i> is FALSE.	BOOL	TRUE / FALSE
RS485_Link_ErrorID	Outputs communication error code. See error codes and their meanings as below: 1: Unidentified function code 2: The address in the response message from the slave is different from the configured address. 3: The length of received data in the response message from the slave is inconsistent with the configured length. 4: Data-receiving timeout 5: Checksum error 6: The configured lengths of data to be read and written are both 0. 7: The length of the data that is actually received exceeds the max. received data length. 8: Data-sending timeout 16#80+ exception code: the exception code from the slave	WORD	
Error	TRUE when an error occurs in the instruction inputs.	BOOL	TRUE / FALSE
ErrorID	Contains error codes when an error occurs in the instruction execution. Please refer to section 12.2 for the corresponding error code.	WORD	

● Output Update Timing

Parameter Name	Timing for changing to TRUE	Timing for changing to FALSE
Valid	◆ When <i>Enable</i> changes from FALSE to TRUE.	◆ When <i>Enable</i> changes from TRUE to FALSE
RS485_Link_Error	◆ When an error occurs in the communication as <i>Enable</i> is TRUE.	◆ The communication is restored to normal. (<i>Error</i> is FALSE.) ◆ When <i>Enable</i> changes from TRUE to FALSE. ◆ When <i>Open</i> of RS485_Link_Manage changes from TRUE to FALSE. (<i>Error</i> is FALSE.)
Error	◆ When an error occurs in the instruction inputs as <i>Enable</i> is TRUE.	◆ When <i>Enable</i> changes from TRUE to FALSE. ◆ When the correct parameter value is filled.

● **Output Update Timing Chart**

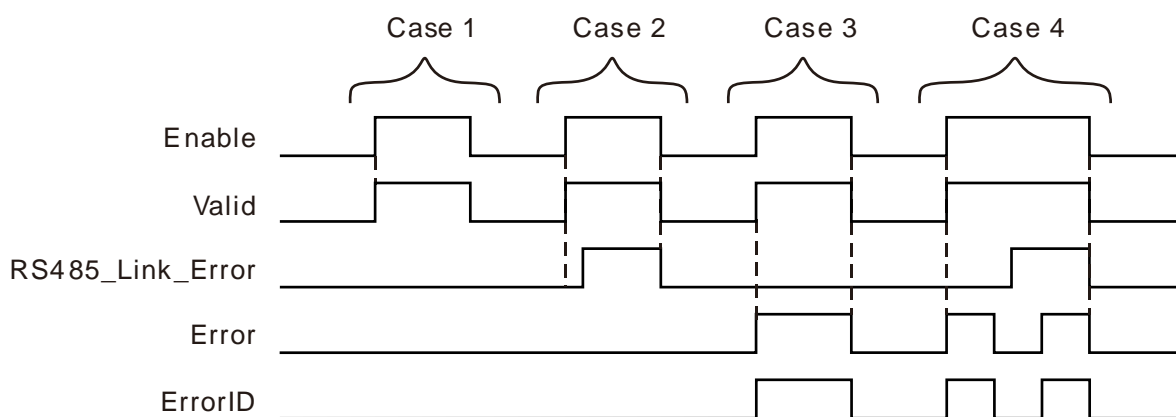

Case 1 : When *Enable* changes from FALSE to TRUE, *Valid* changes from FALSE to TRUE. (There is no error both in the communication and instruction inputs.)

Case 2 : If there is an error in the communication, as *Enable* changes from FALSE to TRUE, *Valid* changes from FALSE to TRUE and after a while, *RS485_Link_Error* changes to TRUE.

Case 3 : If there is an error in the instruction inputs, as *Enable* changes from FALSE to TRUE, *Valid* changes from FALSE to TRUE and *Error* changes to TRUE.

Case 4 : If there is an error both in the communication and in the instruction inputs, as *Enable* changes from FALSE to TRUE, *Valid* changes from FALSE to TRUE, *Error* changes to TRUE and *RS485_Link_Error* is still FALSE. After the input parameter values are modified correctly, *Error* changes to FALSE and after a while, *RS485_Link_Error* changes to TRUE. When the input parameter error occurs again, *Error* changes to TRUE. At the moment, there will be no change in *RS485_Link_Error* no matter whether the communication works normally. When *Enable* is TRUE and *Error* is TRUE, the state of *RS485_Link_Error* will not be refreshed and will be invalid.

● **Function**

RS485_Link_Status is used for watching the communication state of the corresponding link. The firmware of V1.01 and above supports the function.

- **Precaution**

1. The state of *RS485_Link_Error* will not be refreshed and will be invalid when *Enable* is TRUE and *Error* is TRUE.
2. The input value of *LinkNum* can be a number or variable.

8.14.3.4 RS485 Data Exchange Example



Programming Example

- The node address of the slave DVP32ES2 is 1. The values in 10 word registers %MW100~%MW109 of the master are written to D0~D9 in the slave. Then the values in 20 word registers D100~D119 of the slave are read and stored in %MW0~%MW19 in the master as shown in the following variable table 1.

➤ Variable table 1

Variable name	Address	Data type	Initial value
Mng		RS485_Link_Manage	
Mng_En		BOOL	TRUE
Mng_Open		BOOL	FALSE
Mng_Valid		BOOL	
Mng_LOpen		BOOL	
Config		RS485_Link_Config	
Config_Ex		BOOL	FALSE
Config_LN		UINT	1
Config_EL		BOOL	TRUE
Config_Ncyc		BOOL	FALSE
Config_SNI		USINT	1
Config_OT		USINT	0
Config_EFC17		BOOL	FALSE
Config_WBA	%MW100	UINT	
Config_WBAO		USINT	0
Config_WDA		UINT	16#1000
Config_WL		UINT	10
Config_RBA	%MW0	UINT	
Config_RBAO		USINT	0
Config_RDA		UINT	16#44C
Config_RL		UINT	20
Config_RFC		USINT	
Config_TOut		UINT	1000
Config_Done		BOOL	
Config_Err		BOOL	
Config_ErrID		WORD	
LStatus		RS485_Link_Status	
LStatus_En		BOOL	TRUE
LStatus_LN		UINT	1
LStatus_Valid		BOOL	
LStatus_RLE		BOOL	
LStatus_RLEID		BOOL	
LStatus_Err		BOOL	

Variable name	Address	Data type	Initial value
LStatus_ErrID		WORD	

After these parameter settings are done, set `Confg_Ex` to `TRUE` and then `Mng_Open` to `TRUE`. If the configuration need be modified during the communication, the input `Confg_Ex` should be triggered on the rising edge, `Mng_Open` should be set to `FALSE` and then to `TRUE` after the new configuration data are set up.

- The node address of the slave DVP32ES2 is 1. The values in 31 bit devices `%MX0.0~%MX3.6` of the master are written to `Y0~Y30` in the slave. Then the values in `Y0~Y30` of the slave are read and stored in the 31 bit devices `%QX0.1~%QX3.7` in the master as shown in the following variable table 2.

➤ **Variable table 2**

Name	Address	Data type	Initial value
Mng		RS485_Link_Manage	
Mng_En		BOOL	TRUE
Mng_Open		BOOL	FALSE
Mng_Valid			
Mng_LOpen			
Confg		RS485_Link_Config	
Confg_Ex		BOOL	FALSE
Confg_LN		UINT	1
Confg_EL		BOOL	TRUE
Confg_Ncyc		BOOL	FALSE
Confg_SNI		USINT	1
Confg_OT		USINT	1
Confg_EFC17		BOOL	FALSE
Confg_WBA	%MW0	UINT	
Confg_WBAO		USINT	0
Confg_WDA		UINT	16#0400
Confg_WL		UINT	31
Confg_RBA	%QW0	UINT	
Confg_RBAO		USINT	1
Confg_RDA		UINT	16#0400
Confg_RL		UINT	31
Confg_RFC		USINT	
Confg_TOut		UINT	1000
Confg_Done			
Confg_Err			
Confg_ErrID			
LStatus		RS485_Link_Status	
LStatus_En		BOOL	TRUE

Name	Address	Data type	Initial value
LStatus_LN		UINT	1
LStatus_Valid			
LStatus_RLE			
LStatus_RLEID			
LStatus_Err			
LStatus_ErrID			

➤ Program

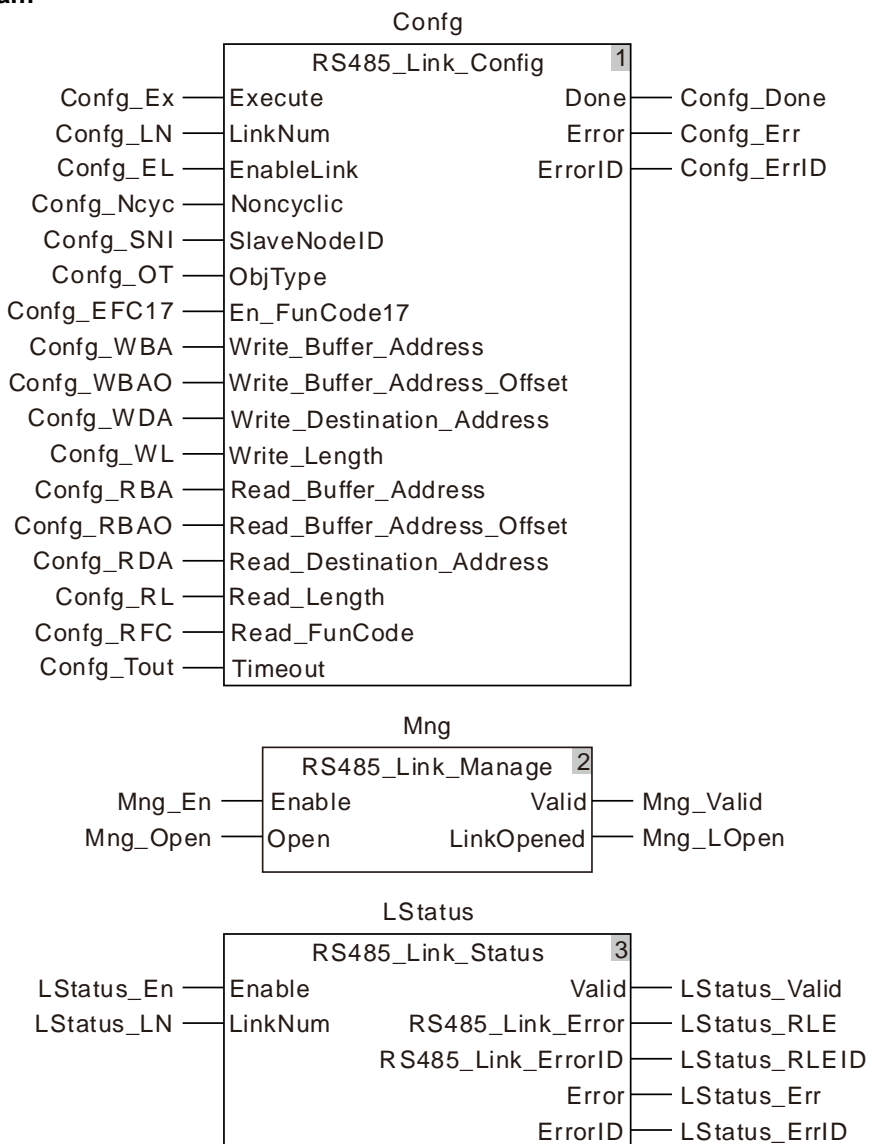

8.14.3.5 RS485_RS

FB/FC	Explanation	Applicable model
FB	RS485_RS is used to configure RS485 free protocol communication parameters for the motion controller.	DVP15MC11T DVP15MC11T-06

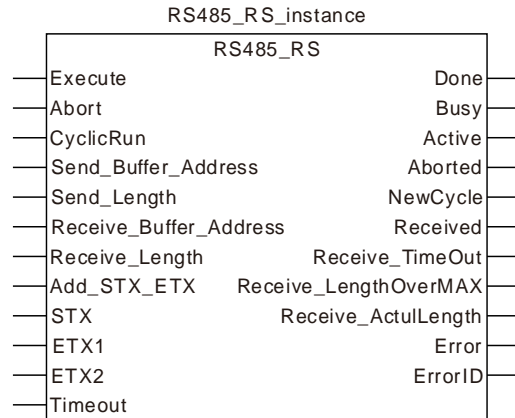

● Input Parameters

Parameter name	Function	Data type	Valid range (Default)	Validation timing
Execute	The instruction is executed when <i>Execute</i> changes from FALSE to TRUE.	BOOL	TRUE or FALSE (FALSE)	
Abort	The free protocol communication is aborted when <i>Abort</i> changes to TRUE.	BOOL	TRUE or FALSE (FALSE)	When <i>Execute</i> changes from FALSE to TRUE
CyclicRun	Communication mode setting for the instruction. FALSE: Non-cyclic; TRUE: Cyclic	BOOL	TRUE or FALSE (FALSE)	When <i>Execute</i> changes from FALSE to TRUE
Send_Buffer_Address	Specify the starting register of the master where the sent data are stored.	USINT	%MB0-%MB32767	When <i>Execute</i> changes from FALSE to TRUE
Send_length	Set the length of sent data.	UINT	0-200 (Byte) (0)	When <i>Execute</i> changes from FALSE to TRUE
Receive_Buffer_Address	Specify the starting register of the master where the received data are stored.	USINT	%MB0-%MB32767	When <i>Execute</i> changes from FALSE to TRUE
Receive_Length	Set the length of received data.	UINT	0-200(Byte) (0)	When <i>Execute</i> changes from FALSE to TRUE
Add_STX_ETX	Set if the start and end codes are added or not in sent messages. FALSE: Not add the start and end codes. TRUE: Add the start and end codes.	BOOL	TRUE or FALSE (FALSE)	When <i>Execute</i> changes from FALSE to TRUE

Parameter name	Function	Data type	Valid range (Default)	Validation timing
STX	Set the start of messages.	USINT	0-16#7F (16#3A)	When <i>Execute</i> changes from FALSE to TRUE
ETX1	Set the first end of messages.	USINT	0-16#7F (16#0D)	When <i>Execute</i> changes from FALSE to TRUE
ETX2	Set the second end of messages.	USINT	0-16#7F (16#0A)	When <i>Execute</i> changes from FALSE to TRUE
TimeOut	Set the timeout time when receiving data.	UINT	0-32767 (0)	When <i>Execute</i> changes from FALSE to TRUE

- **Output Parameters**

Parameter name	Function	Data type	Valid range
Done	TRUE when the instruction execution is completed.	BOOL	TRUE / FALSE
Busy	TRUE when the communication proceeds.	BOOL	TRUE / FALSE
Aborted	TRUE when current execution of the instruction is aborted.	BOOL	TRUE / FALSE
Active	TRUE when the port is controlled by the instruction.	BOOL	TRUE / FALSE
NewCycle	TRUE when the instruction execution is completed once (in the multi-cycle state)	BOOL	TRUE / FALSE
Received	TRUE when receiving is successful.	BOOL	TRUE / FALSE
Receive_TimeOut	TRUE when timeout in message receiving occurs.	BOOL	TRUE / FALSE
Receive_LengthOverMAX	TRUE when the length of received data exceeds the max. length allowed.	BOOL	TRUE / FALSE
Receive_ActualLength	Actually received data length	UINT	0-200
Error	TRUE when an instruction configuration error occurs.	BOOL	TRUE / FALSE
ErrorID	Contains error codes when an error occurs in the instruction execution. Please refer to section 12.2 for the corresponding error code.	WORD	

● **Output Update Timing**

Parameter Name	Timing for changing to TRUE	Timing for changing to FALSE
Done	<ul style="list-style-type: none"> ◆ After <i>Execute</i> changes from FALSE to TRUE and <i>Busy</i> changes to TRUE in the one single cycle work state 	<ul style="list-style-type: none"> ◆ When <i>Execute</i> changes from TRUE to FALSE in the single cycle work state.
Busy	<ul style="list-style-type: none"> ◆ When <i>Execute</i> changes from FALSE to TRUE. 	<ul style="list-style-type: none"> ◆ When <i>Abort</i> changes to TRUE in the multi-cycle state. ◆ When <i>Done</i> changes to TRUE in the one-single-cycle state.
Aborted	<ul style="list-style-type: none"> ◆ When <i>Abort</i> changes from FALSE to TRUE for the first time. ◆ When current instruction is aborted by another instruction in the multi-cycle state. 	<ul style="list-style-type: none"> ◆ When <i>Abort</i> changes from TRUE to FALSE. ◆ When <i>Execute</i> changes from TRUE to FALSE. ◆ When <i>Execute</i> is FALSE and <i>Abort</i> changes from FALSE to TRUE, <i>Aborted</i> changes to TRUE and one cycle later, changes to FALSE.
Active	<ul style="list-style-type: none"> ◆ When <i>Execute</i> changes from FALSE to TRUE. 	<ul style="list-style-type: none"> ◆ When <i>Execute</i> changes from TRUE to FALSE ◆ When current instruction is aborted by another instruction in the multi-cycle state. ◆ When <i>Done</i> changes to TRUE in the one-single-cycle state.
NewCycle	<ul style="list-style-type: none"> ◆ When the PLC completes one cycle of work in the multi-cycle state. 	<ul style="list-style-type: none"> ◆ When the instruction enters the next cycle for receiving and sending data.
Received	<ul style="list-style-type: none"> ◆ When the instruction receives the response message. 	<ul style="list-style-type: none"> ◆ When the next cycle is entered after the instruction receives the response message.
Receive_TimeOut	<ul style="list-style-type: none"> ◆ When the parameter configuration for receiving data has been done and the response message is not received within the set timeout time. 	<ul style="list-style-type: none"> ◆ When the response message is received.
Receive_LengthOverMAX	<ul style="list-style-type: none"> ◆ When the length of actually received data is greater than the max. length allowed. 	<ul style="list-style-type: none"> ◆ When the length of received data is less than the max. length allowed.
Error	<ul style="list-style-type: none"> ◆ When an error occurs in the instruction parameter configuration. 	<ul style="list-style-type: none"> ◆ When the instruction configuration data are correct.

● **Output Update Timing Chart**

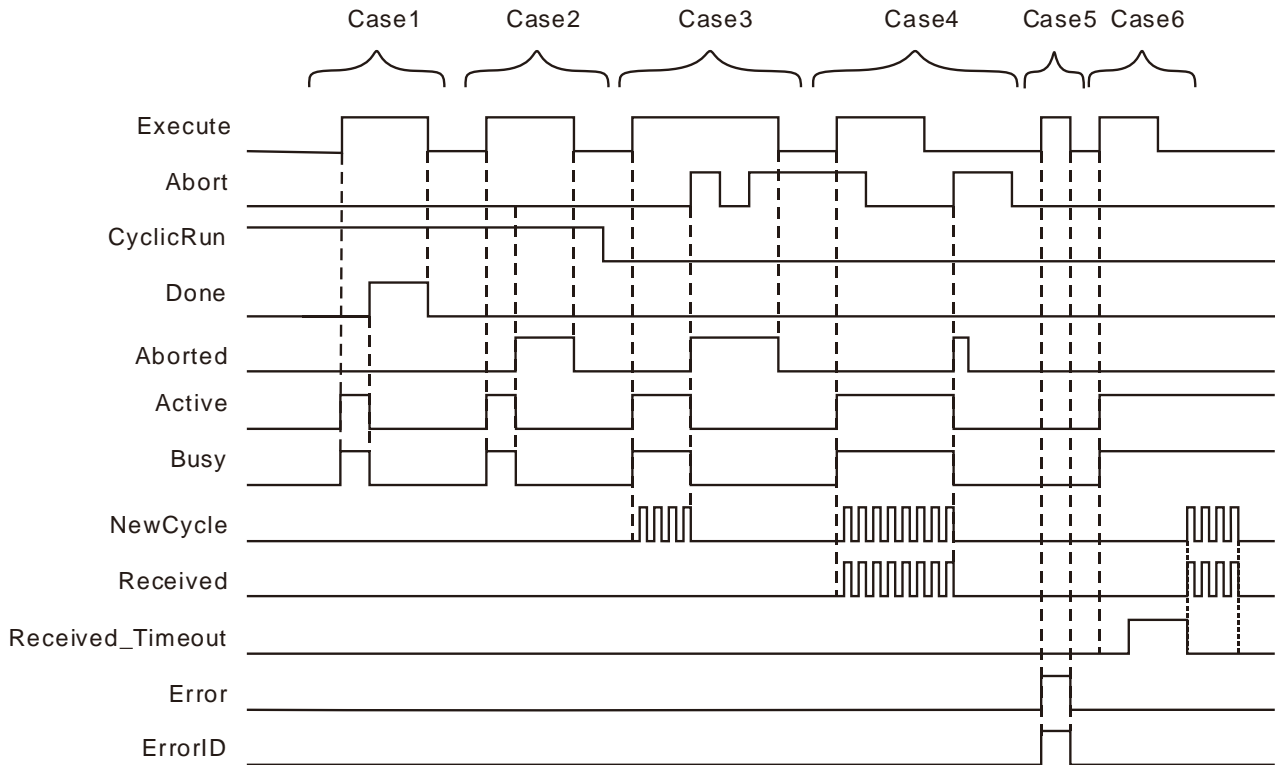

- Case 1 :** In the one-single-cycle work state, *Busy* changes to TRUE when *Execute* changes from FALSE to TRUE. When the instruction execution is completed, *Busy* changes to FALSE and *Done* changes to TRUE. When *Execute* changes to FALSE, *Done* changes to FALSE.
- Case 2 :** In the one-single-cycle work state, *Busy* and *Active* change to FALSE and *Abort* changes to TRUE when the instruction is aborted by other instruction. Then *Aborted* changes to FALSE when *Execute* changes to FALSE. If *Execute* changes to FALSE before the instruction is aborted, *Aborted* changes to TRUE for one cycle.
- Case 3 :** In the multi-cycle state where only the data-sending parameters are configured, when *Execute* changes from FALSE to TRUE, *Busy* changes to TRUE. After a while, *Newcycle* changes between TRUE and FALSE alternately. When *Abort* changes to TRUE, *Busy* changes to FALSE and *Aborted* to TRUE. When *Abort* changes to FALSE, *Aborted* remains TRUE. *Aborted* remains TRUE when *Abort* changes to TRUE again. *Aborted* changes to FALSE when *Execute* changes from TRUE to FALSE.
- Case 4 :** In the multi-cycle state where the parameters for receiving and sending data have been configured and *Abort* is TRUE, *Busy* changes to TRUE when *Execute* changes from FALSE to TRUE. After a while, both of *Newcycle* and *Received* begin to change between TRUE and FALSE alternately. When triggering *Abort* again after *Execute* changes from TRUE to FALSE, *Aborted* changes to TRUE, one cycle later, changes to FALSE and others change to FALSE.
- Case 5 :** If there is an error in the configured parameters of the instruction, *Error* changes to TRUE as *Execute* changes from FALSE to TRUE. *Error* changes to FALSE as *Execute* changes to FALSE.

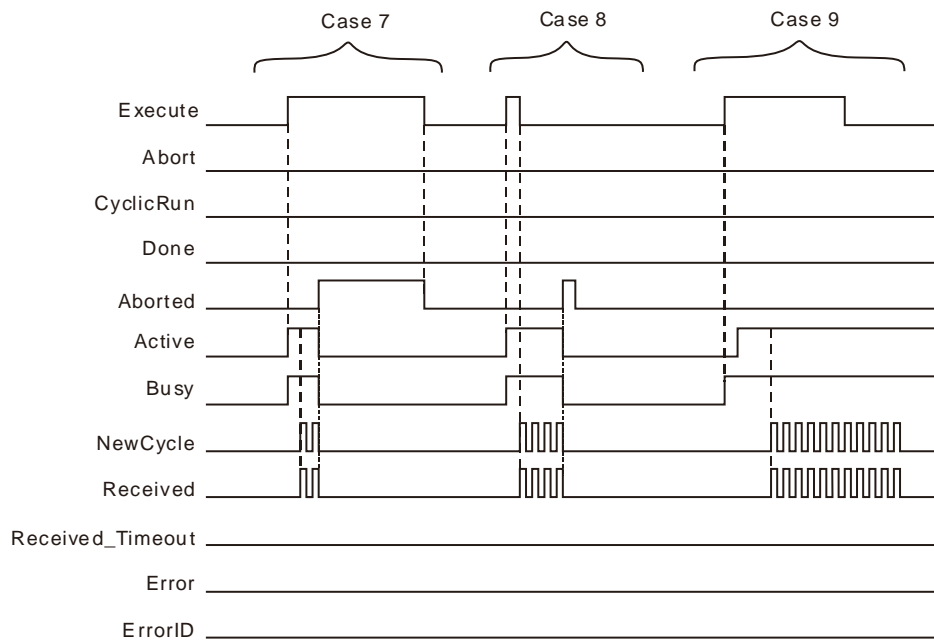

Case 6 : In the event that the timeout of receiving data occurs, when *Execute* changes from FALSE to TRUE, *Busy* changes to TRUE and after a while, *Received_Timeout* changes to TRUE. When the communication is restored to normal, both of *NewCycle* and *Received* start to change between TRUE and FALSE alternately.

Case 7 : In the multi-cycle state where *Execute* is TRUE, when the instruction is aborted by other instruction, *Aborted* changes to TRUE, *Execute* changes to FALSE and *Aborted* changes to FALSE.

Case 8 : In the multi-cycle state where *Execute* is FALSE, when the instruction is aborted by other instruction, *Aborted* changes to TRUE and one cycle later, changes to FALSE.

Case 9 : When the instruction is aborted by other instruction, *Busy* changes to TRUE. After a while, *Active* changes to TRUE and other outputs give corresponding output according to the cases above.

- **Function**

RS485_RS is used to configure RS485 free protocol communication parameters and watch the communication status. The firmware of V1.01 and above supports the function.

- **Precaution**

1. RS485_RS does not add the checksum automatically. In ASCII mode, the data sent out are required to be the ASCII message which has been converted into.
2. The total length of sent data is 200 Bytes. The length set in the instruction does not include that of the start and end of sent messages.
3. Add_STX_ET sets if the header and footer codes are added or not in the sent message. The function is only enabled when the header and footer codes of the sent message are identical to those of the received message. Otherwise, the function can not be enabled if the header and footer codes of the sent message differ from those of the received message and in this case, an error will occur if the function is enabled.
 - a. The header code and footer code set in the instruction are for the sent messages. If the sent message is correct but the header code and footer code in the received message are different from those of the sent message, the controller will fail to receive the message and the timeout will happen during receiving.
 - b. The header code and footer code set in the instruction are for the sent message. So the slave will not give a response if the sent message does not conform to the slave message requirement. Thus, the function could not be enabled when the header and footer codes of the sent message are not identical to those of the received message.

4. When RS485_RS and RS_485_Link_Config exist together,
 - a) When *Execute* of RS485_RS instruction changes from FALSE to TRUE, the 485Link function of the PLC will take effect.
 - b) When *Abort* of RS485_RS instruction changes from FALSE to TRUE, the 485Link function which is being performed will take effect again.
 - c) When *Execute* of RS485_RS instruction changes from FALSE to TRUE, *Enable* of RS485_Link_Manage changes to TRUE, *Open* of the instruction can control the functions of 485 link and free protocol communication.
 - d) If there are several RS485_RS instructions in the program, only one of them, which is triggered the last time will take effect.
 - e) For the message which is sent out via RS485_RS instruction, the address where received data are stored must be set in the RS485_RS instruction if the slave sends the response message.

8.14.3.6 RS485 Free Protocol Example



Programming Example 1

◆ Enabling the function of the start and end of messages

The free protocol is applied to send a standard Modbus message in ASCII mode with the starting address %MB4000 where sent data are stored and %MB5000 where received data are stored and receive the response data from the slave.

Message content: 01 10 15 00 00 01 02 00 08.

The checksum CF is calculated first. Then the message is converted into ASCII code.

Message content after conversion: 30 31 31 30 31 35 30 30 30 30 30 31 30 32 30 30 30 38 43 46.

If the parameters of RS485_RS instruction are configured based on variable table 1, the data in %MB4000~%MB4019 are 30 31 31 30 31 35 30 30 30 30 30 31 30 32 30 30 30 38 43 46.

The message data on the bus: 3A 30 31 31 30 31 35 30 30 30 30 30 31 30 32 30 30 30 38 43 46 0D 0A.

■ Variable table 1

Variable name	Address	Data type	Initial value
RS		RS485_RS	
RS_Ex		BOOL	FALSE
RS_Abort		BOOL	FALSE
RS_CyRun		BOOL	TRUE
RS_SBA	%MB4000	USINT	16#30
RS_SL		UINT	20
RS_RBA	%MB5000	USINT	
RS_RL		UINT	23
RS_AddSE		BOOL	1
RS_Tout		UINT	500
RS_Done		BOOL	
RS_Bsy		BOOL	
RS_Abt		BOOL	
RS_Act		BOOL	
RS_NCyc		BOOL	
RS_Rec		BOOL	
RS_RTO		BOOL	
RS_RLOM		BOOL	
RS_RAL		UINT	
RS_Err		BOOL	
RS_ErrID		WORD	

◆ Disabling the function of the start and end of messages

1. The free protocol is applied to send a standard Modbus message in ASCII mode with the starting address %MB4000 where sent data are stored and %MB5000 where received data are stored and receive the response data from the slave.

Message content: 01 10 15 00 00 01 02 00 08 .

The checksum CF is calculated first. Then the message is converted into ASCII code.

Message content after conversion: 3A 30 31 31 30 31 35 30 30 30 30 31 30 32 30 30 30 38 43 46 0D 0A

2. If the parameters of RS485_RS instruction are configured based on variable table 2, the data in %MB4000~%MB4022 are 3A 30 31 31 30 31 35 30 30 30 30 31 30 32 30 30 30 38 43 46 0D 0A

The message data on the bus: 3A 30 31 31 30 31 35 30 30 30 30 31 30 32 30 30 30 38 43 46 0D 0A

➤ **Variable table 2**

Variable name	Address	Data type	Initial value
RS		RS485_RS	
RS_Ex		BOOL	FALSE
RS_Abort		BOOL	FALSE
RS_CyRun		BOOL	TRUE
RS_SBA	%MB4000	USINT	16#3A
RS_SL		UINT	23
RS_RBA	%MB5000	USINT	
RS_RL		UINT	23
RS_AddSE		BOOL	0
RS_Tout		UINT	500
RS_Done		BOOL	
RS_Bsy		BOOL	
RS_Abt		BOOL	
RS_Act		BOOL	
RS_NCyc		BOOL	
RS_Rec		BOOL	
RS_RTO		BOOL	
RS_RLOM		BOOL	
RS_RAL		UINT	
RS_Err		BOOL	
RS_ErrID		WORD	

➤ Program

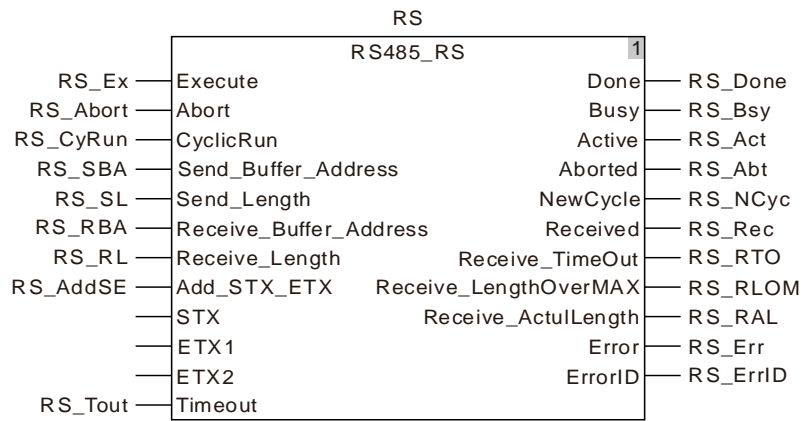

8.14.3.7 RS485_SetDelayTime

FB/FC	Explanation	Applicable model
FB	RS485_SetDelayTime sets the response-delay time at the RS485 communication port of the controller.	DVP15MC11T DVP15MC11T-06

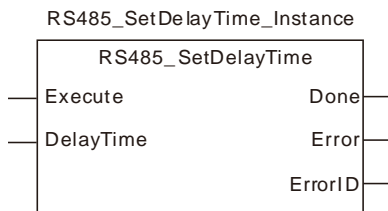

● Input Parameters

Parameter name	Function	Data type	Valid range (Default)	Validation timing
Execute	The instruction is executed when <i>Execute</i> changes from FALSE to TRUE.	BOOL	TRUE or FALSE (FALSE)	-
DelayTime	The response-delay time at the RS485 communication port of the controller. It is valid no matter whether the controller serves as a master or a slave. (Unit: ms)	UINT	0~65535 (0)	When <i>Execute</i> changes to TRUE

● Output Parameters

Parameter name	Function	Data type	Valid range
Done	TRUE when the instruction execution is completed.	BOOL	TRUE / FALSE
Error	TRUE when there is an error.	BOOL	TRUE / FALSE
Error ID	Contains error codes when an error occurs. Please refer to section 12.2 for the corresponding error code.	WORD	

● Output Update Timing

Parameter Name	Timing for changing to TRUE	Timing for changing to FALSE
Done	◆ When the instruction execution is completed.	◆ When <i>Execute</i> changes from TRUE to FALSE
Error	◆ When an error occurs in the instruction execution or the input parameters for the instruction are illegal.	◆ When <i>Execute</i> changes from TRUE to FALSE

- **Output Update Timing Chart**

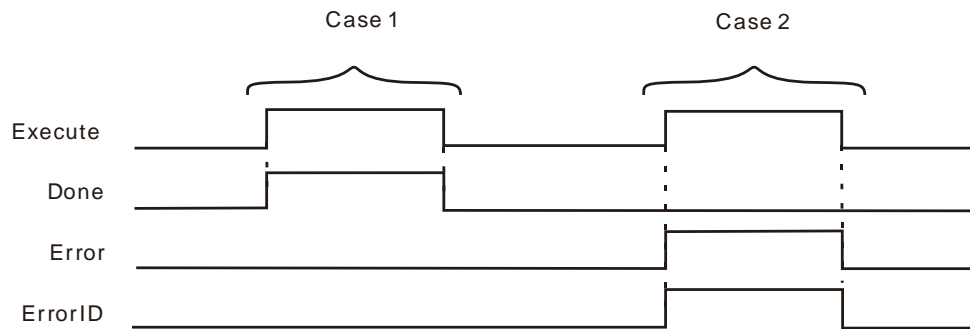

Case 1 : When *Execute* changes from FALSE to TRUE, *DONE* changes from FALSE to TRUE.

Case 2 : When an error occurs as *Execute* changes from FALSE to TRUE, *Error* changes to TRUE and *ErrorID* shows corresponding error codes. *Error* changes to FALSE when *Execute* changes from TRUE to FALSE.

- **Function**

The RS485_SetDelayTime instruction is used to set the response-delay time of the controller RS485 communication port. The setting time is valid when the RS485 communication port of the controller serves as a master or slave.

When RS485 communication port works as a master, it will not send a next message until the set delay time elapses after receiving the response data from the slave. When the RS485 communication port works as a slave, it will not reply to the master until the set delay time elapses after receiving the data from the master.

8.14.4 RS232 Communication Instructions

8.14.4.1 RS232_Link_Manage

FB/FC	Explanation	Applicable model
FB	RS232_Link_Manage is used for switching on or off RS232 communication.	DVP15MC11T DVP15MC11T-06

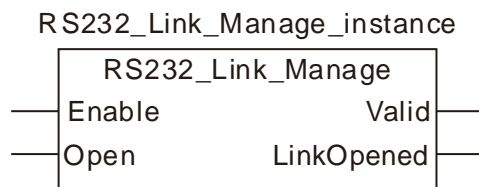

● **Input Parameters**

Parameter name	Function	Data type	Valid range (Default)	Validation timing
Enable	The instruction is executed when <i>Enable</i> changes from FALSE to TRUE.	BOOL	TRUE or FALSE (FALSE)	-
Open	232 communication is switched on or off.	BOOL	TRUE or FALSE (FALSE)	When <i>Enable</i> changes from FALSE to TRUE

● **Output Parameters**

Parameter name	Function	Data type	Valid range
Valid	TRUE when the outputs of the instruction are valid.	BOOL	TRUE / FALSE
LinkOpened	TRUE when 232 communication is enabled.	BOOL	TRUE / FALSE

● **Output Update Timing**

Parameter Name	Timing for changing to TRUE	Timing for changing to FALSE
Valid	◆ When <i>Enable</i> changes to TRUE	◆ When <i>Enable</i> changes from TRUE to FALSE
LinkOpened	◆ When <i>Enable</i> changes to TRUE and <i>Open</i> changes to TRUE	◆ When <i>Enable</i> changes from TRUE to FALSE ◆ When <i>Open</i> changes from TRUE to FALSE

● **Output Update Timing Chart**

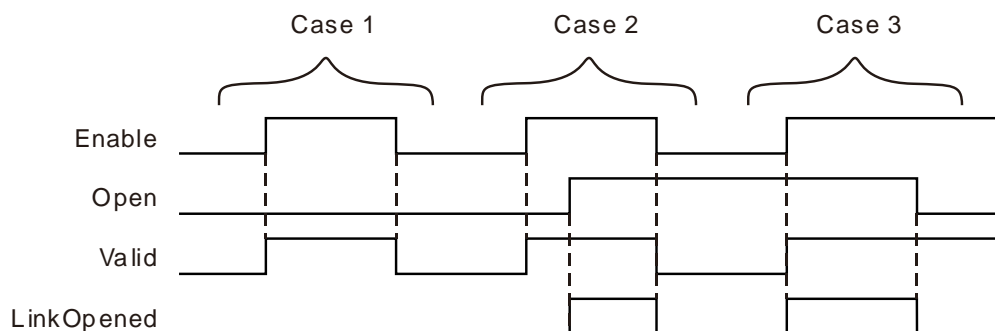

- Case 1** : When *Enable* changes from FALSE to TRUE, *Open* changes to FALSE, *Valid* changes to TRUE and *LinkOpened* changes to FALSE.
- Case 2** : As *Enable* changes from FALSE to TRUE, *Valid* changes to TRUE. In this case, *LinkOpened* changes to TRUE as *Open* changes from FALSE to TRUE. When *Enable* changes from TRUE to FALSE, *Valid* and *LinkOpened* change to FALSE.
- Case 3** : As *Open* is TRUE and *Enable* changes from FALSE to TRUE, *Valid* and *LinkOpened* change to TRUE. As *Open* changes to FALSE, *LinkOpened* changes to FALSE.

- **Function**

RS232_Link_Manage is used to enable or disable the RS232 communication. The firmware of V1.01 and above supports the function.

1. The input *Enable* is used to control the instruction to take effect or not. When *Enable* changes to FALSE, the operation of other parameters of the instruction will be invalid. When *Enable* changes to TRUE, the instruction takes effect and then the operation of other parameter of the instruction will be valid.
2. In the case that *Enable* is TRUE, the RS232 communication is switched on as *Open* changes to TRUE. The RS232 communication is switched off as *Open* is FALSE.
3. Before the RS232 communication function is switched on, the parameters of the RS232_Link_Config instruction must have been configured. Otherwise, the configured parameters will be not effective if the RS232 function is switched on before the parameters of the RS232_Link_Config instruction are configured, unless the RS232 communication function is re-switched on.
4. After multiple *LinkNum* parameters are configured through RS232_Link_Config instructions, only one RS232_Link_Manage instruction is enough to switch on the RS232 communication function. And all configurations specified by RS232_Link_Config instructions are for the exchange data with the slave.

8.14.4.2 RS232_Link_Config

FB/FC	Explanation	Applicable model
FB	RS232_Link_Config is used for configuration of RS232 communication parameters of the motion controller.	DVP15MC11T DVP15MC11T-06

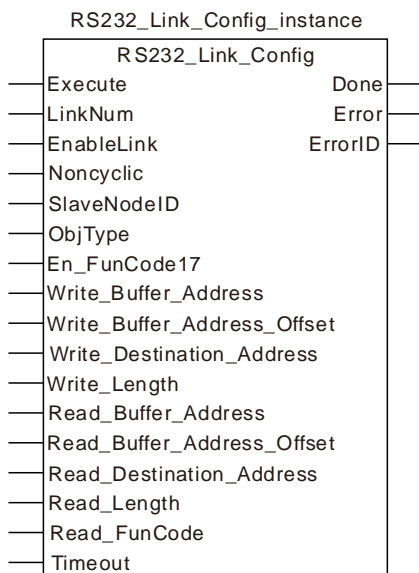

● Input Parameters

Parameter name	Function	Data type	Valid range (Default)	Validation timing
Execute	The instruction is executed when <i>Execute</i> changes from FALSE to TRUE.	BOOL	TRUE or FALSE (FALSE)	
LinkNum	Specify the number of the Link.	UINT	1~24 (The variable value must be set)	When <i>Execute</i> changes from FALSE to TRUE
EnableLink	Enable or disable the Link.	BOOL	TRUE or FALSE (FALSE)	When <i>Execute</i> changes from FALSE to TRUE
Noncyclic	Set the Link communication mode FALSE: Cyclic, TRUE: Non-cyclic	BOOL	TRUE or FALSE (FALSE)	When <i>Execute</i> changes from FALSE to TRUE
SlaveNodeID	Set the node ID of the 232 slave	USINT	0~255 (0)	When <i>Execute</i> changes from FALSE to TRUE
ObjType	Set the type of the slave register to be read and written. 0: Word register 1: Bit register	USINT	0~1 (0)	When <i>Execute</i> changes from FALSE to TRUE
En_FunCode17	Set if the function code 17 is used or not.	BOOL	TRUE or FALSE (FALSE)	When <i>Execute</i> changes from FALSE to TRUE
Write_Buffer_Address	The starting register of the master where the data sent are stored	UINT	%MW0 ~ %MW32767 %QW0 ~ %QW63	When <i>Execute</i> changes from FALSE to TRUE

Parameter name	Function	Data type	Valid range (Default)	Validation timing
Write_Buffer_Address_Offset	Set the offset of the starting register of the master sending data. The setting value 1 means the offset is 1 word if the word address of the slave is written. The setting value 1 means the offset is 1 bit if the bit address of the slave is written.	USINT	0~255 (0)	When <i>Execute</i> changes from FALSE to TRUE
Write_Destination_Address	Set the starting address of the MODBUS slave receiving the data from the master	UINT	Standard Modbus address	When <i>Execute</i> changes from FALSE to TRUE
Write_Length	The length of data to be written	UINT	Word register: 0~100 Bit device: 0~256	When <i>Execute</i> changes from FALSE to TRUE
Read_Buffer_Address	The starting register of the master where data received are stored.	UINT	%MW0~%MW32767 %QW0~%QW63	When <i>Execute</i> changes from FALSE to TRUE
Read_Buffer_Address_Offset	Set the offset of the starting register of the master receiving data. The setting value 1 means the offset is 1 word if the word register of the slave are read. The setting value 1 means the offset is 1 bit if the bit register of the slave are read.	USINT	0~255 (0)	When <i>Execute</i> changes from FALSE to TRUE
Read_Destination_Address	Set the starting address of the MODBUS slave to be read by the master	UINT	Standard Modbus address	When <i>Execute</i> changes from FALSE to TRUE
Read_Length	The length of data to be read	UINT	Word register: 0~100 Bit register: 0~256	When <i>Execute</i> changes from FALSE to TRUE
Read_FunCode	Select the function code used for reading Bit address.	USINT	1: function code 01 2: function code 02 (2)	When <i>Execute</i> changes from FALSE to TRUE
Timeout	Set the time for the master to wait for the slave's response. The slave timeout occurs if the slave does not respond to the master request within the set time. Unit: ms	UINT	An integer greater than 0 (300)	When <i>Execute</i> changes from FALSE to TRUE

- **Output Parameters**

Parameter name	Function	Data type	Valid range
Done	TRUE When the configuration of Link parameters is successful.	BOOL	TRUE / FALSE
Error	TRUE when an error occurs in execution of the instruction.	BOOL	TRUE / FALSE
Error ID	Contains the error code when an error occurs. Please refer to section 12.2 for the corresponding error ID.	WORD	

● **Output Update Timing**

Parameter Name	Timing for changing to TRUE	Timing for changing to FALSE
Done	◆ When the configuration of parameters is correct and <i>Execute</i> changes from FALSE to TRUE.	◆ When <i>Execute</i> changes from TRUE to FALSE
Error	◆ When the configuration of parameters is incorrect and <i>Execute</i> changes from FALSE to TRUE.	◆ When <i>Execute</i> changes from TRUE to FALSE ◆ When <i>Execute</i> is re-triggered after the parameter configuration is modified correctly.

● **Output Update Timing Chart**

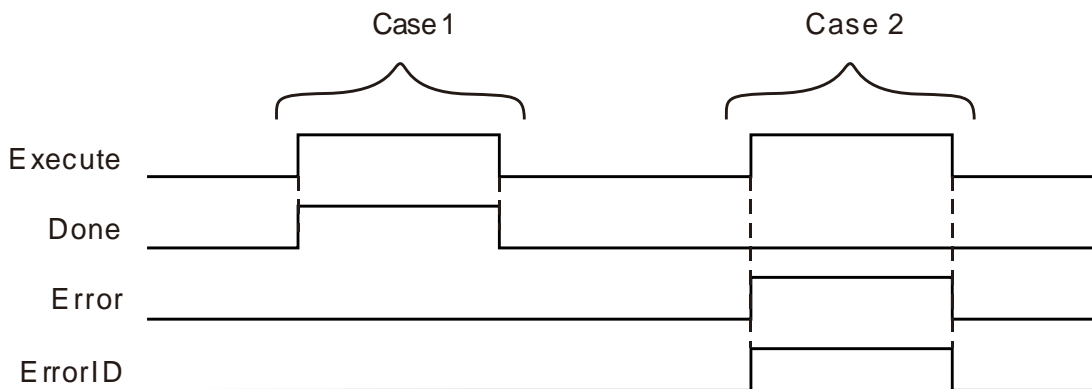

Case 1 : When the configuration of parameters is correct and *Execute* changes from FALSE to TRUE, *Done* changes from FALSE to TRUE.

Case 2 : When the configuration of parameters is incorrect and *Execute* changes from FALSE to TRUE, *Done* is FALSE and *Error* changes from FALSE to TRUE.

● **Function**

RS232_Link_Config is used to configure parameters for 232 communication Link. The firmware of V1.01 and above supports the function.

● **Precaution**

- ObjType* is the data type of the read and written parameter. When *ObjType* is 0, it means to read and write the word register of the slave. The range of Write_Length and Read_Length is 0~100 and the values of Write_Length and Read_Length can not be 0 at the same time. When *ObjType* is 1, it means to read and write the bit register of the slave. The range of Write_Length and Read_Length is 0~256 and the values of Write_Length and Read_Length can not be 0 at the same time. For local addresses, you can directly fill addresses, variables combined with addresses, arrays combined with the starting addresses.
- For local address to fill the %MB address, you can only fill the low byte of the %MW address rather than the high byte.

3. For the register address of the slave, you can directly fill the MODBUS address and variable.
4. For the offset in the word operation, the actual address is calculated by word. For the offset in the bit operation, the actual address is calculated by bit.
For example:
 - a) Actual address calculated via word offset :
When the address is %MW0 and the offset is 15, the actual operation address is %MW15=%MW (0+15).
 - b) Actual address calculated via bit offset:
When the address is %QW0 and the offset is 7, the actual operation address is %QX0.7.
5. If you choose to read and write the word register of the slave, the %MW register of the local device can be regarded as the storage register for reading and writing data. The range of the storage register is %MW0~%MW32767. If the range is exceeded or other register is used, an error will occur in the instruction.
6. If you choose to read and write the bit register of the slave, the %MW and %QW registers of the local device can be regarded as the storage registers for reading and writing data. The ranges of the storage register are %MW0~%MW32767 and %QW0~%QW63. If the ranges are exceeded or other register is used, an error will occur in the instruction.
7. The set parameter values of this instruction are only valid during the operation of the PLC. When the motion controller is repowered after the power off, the parameters configured before the power off are all invalidated. The ETH_Link_Config instruction must be re-executed if the configuration before the power off is needed to use.
8. When the bit registers of the slave are read, the value of Read_FunCode must be set to 01 or 02. You can select the function code according to the type of the bit register through referring to the corresponding module manual.
9. Set the communication mode via the input parameter *Noncyclic*. The communication mode is the cyclic communication mode if *Noncyclic* is set to FALSE. The communication mode is the non-cyclic communication mode if *Noncyclic* is set to TRUE.
 - a. Cyclic Communication Mode: When the current Link is set as cyclic communication mode. The configuration for the Link will be effective immediately and the data exchange between the master and slave will be conducted cyclically after RS232 communication function is enabled via RS232_Link_Manage instruction.
The configuration for the link will not be executed and the data exchange with the slave will stop after RS232 communication function is disabled via RS232_Link_Manage instruction.
 - b. Non-Cyclic Communication Mode: When the current Link is set as non-cyclic communication mode. The configuration for the Link will be effective immediately and the data exchange between the master and slave will be conducted only once after RS232 communication function is enabled via RS232_Link_Manage instruction.
If the data exchange between the master and the slave is to be made once again, re-enable RS232 communication function after RS232 communication function is disabled via RS232_Link_Manage instruction.

8.14.4.3 RS232_Link_Status

FB/FC	Explanation	Applicable model
FB	RS232_Link_Status is used to watch if an error occurs in the 232 link which the number corresponds to or the slave replies with error codes.	DVP15MC11T DVP15MC11T-06

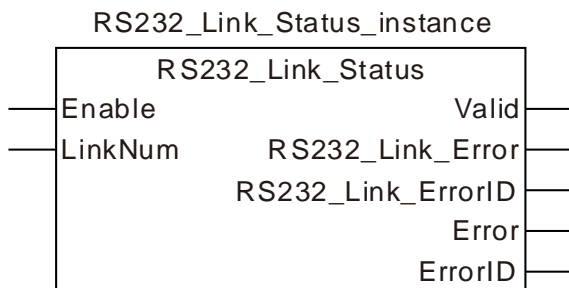

● Input Parameters

Parameter name	Function	Data type	Valid range (Default)	Validation timing
Enable	The instruction is validated when <i>Enable</i> changes from FALSE to TRUE.	BOOL	TRUE or FALSE (FALSE)	
LinkNum	The number of the link to be watched.	UINT	1~24 (The variable value must be set)	When <i>Enable</i> changes from FALSE to TRUE

● Output Parameters

Parameter name	Function	Data type	Valid range
Valid	TRUE when the outputs of the instruction are valid.	BOOL	TRUE / FALSE
RS232_Link_Error	TRUE when an error occurs in the corresponding link. It is valid when <i>Error</i> is FALSE.	BOOL	TRUE / FALSE
RS232_Link_ErrorID	Outputs communication error code. See error codes and their meanings as below: 1: Unidentified function code 2: The address in the response message from the slave is different from the configured address. 3: The length of received data in the response message from the slave is inconsistent with the configured length. 4: Data-receiving timeout 5: Checksum error 6: The configured lengths of data to be read and written are both 0. 7: The length of the data that is actually received exceeds the max. received data length. 8: Data-sending timeout 16#80+ exception code: the exception code from the slave	WORD	
Error	TRUE when an error occurs in the instruction inputs.	BOOL	TRUE / FALSE
ErrorID	Contains error codes when an error occurs in the instruction execution. Please refer to section 12.2 for the corresponding error code.	WORD	

- **Output Update Timing**

Parameter Name	Timing for changing to TRUE	Timing for changing to FALSE
Valid	◆ When <i>Enable</i> changes from FALSE to TRUE	◆ When <i>Enable</i> changes from TRUE to FALSE.
RS232_Link_Error	◆ When an error occurs in the communication as <i>Enable</i> is TRUE.	◆ The communication is restored to normal. (<i>Error</i> is FALSE.) ◆ When <i>Enable</i> changes from TRUE to FALSE. ◆ When <i>Open</i> of RS232_Link_Manage changes from TRUE to FALSE. (<i>Error</i> is FALSE.)
Error	◆ When an error occurs in the instruction inputs as <i>Enable</i> is TRUE.	◆ When <i>Enable</i> changes from TRUE to FALSE. ◆ When the correct parameter value is filled.

- **Output Update Timing Chart**

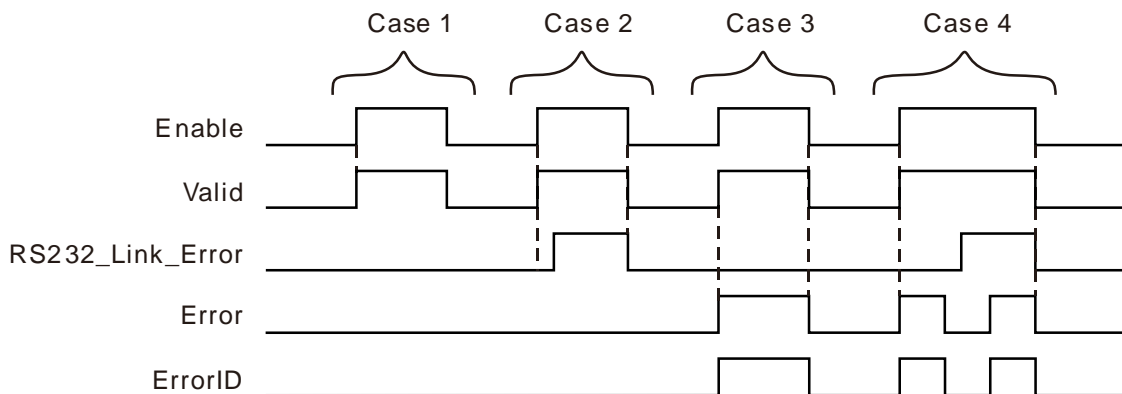

- Case 1 :** When *Enable* changes from FALSE to TRUE, *Valid* changes from FALSE to TRUE. (There is no error both in the communication and instruction inputs.)
- Case 2 :** If there is an error in the communication, as *Enable* changes from FALSE to TRUE, *Valid* changes from FALSE to TRUE and after a while, *RS232_Link_Error* changes to TRUE.
- Case 3 :** If there is an error in the instruction inputs, as *Enable* changes from FALSE to TRUE, *Valid* changes from FALSE to TRUE and *Error* changes to TRUE.
- Case 4 :** If there is an error both in the communication and in the instruction inputs, as *Enable* changes from FALSE to TRUE, *Valid* changes from FALSE to TRUE, *Error* changes to TRUE and *RS232_Link_Error* is still FALSE. After the input parameter values are modified correctly, *Error* changes to FALSE and after a while, *RS232_Link_Error* changes to TRUE. When the input parameter error occurs again, *Error* changes to TRUE. At the moment, there will be no change in *RS232_Link_Error* no matter whether the communication works normally. When *Enable* is TRUE and *Error* is TRUE, the state of *RS232_Link_Error* will not be refreshed and will be invalid.

- **Function**

RS232_Link_Status is used for watching the communication state of the corresponding link. The firmware of V1.01 and above supports the function.

- **Precaution**

1. The state of *RS232_Link_Error* will not be refreshed and will be invalid when *Enable* is TRUE and *Error* is TRUE.
2. The input value of *LinkNum* can be a number or variable.

8.14.4.4 RS232 Data Exchange Example



Programming Example

- The node address of the slave DVP32ES2 is 1. The values in 10 word registers %MW100~%MW109 of the master are written to D0~D9 in the slave. Then the values in 20 word registers D100~D119 of the slave are read and stored in %MW0~%MW19 in the master as shown in the following variable table 1.

➤ Variable table 1

Name	Address	Data type	Initial value
Mng		RS232_Link_Manage	
Mng_En		BOOL	TRUE
Mng_Open		BOOL	FALSE
Mng_Valid		BOOL	
Mng_LOpen		BOOL	
Confg		RS232_Link_Config	
Confg_Ex		BOOL	FALSE
Confg_LN		UINT	1
Confg_EL		BOOL	TRUE
Confg_Ncyc		BOOL	FALSE
Confg_SNI		USINT	1
Confg_OT		USINT	0
Confg_EFC17		BOOL	FALSE
Confg_WBA	%MW100	UINT	
Confg_WBAO		USINT	0
Confg_WDA		UINT	16#1000
Confg_WL		UINT	10
Confg_RBA	%MW0	UINT	
Confg_RBAO		USINT	0
Confg_RDA		UINT	16#44C
Confg_RL		UINT	20
Confg_RFC		USINT	
Confg_TOut		UINT	1000
Confg_Done		BOOL	
Confg_Err		BOOL	
Confg_ErrID		WORD	
LStatus		RS232_Link_Status	
LStatus_En		BOOL	TRUE
LStatus_LN		UINT	1
LStatus_Valid		BOOL	
LStatus_RLE		BOOL	
LStatus_RLEID		BOOL	

Name	Address	Data type	Initial value
LStatus_Err		BOOL	
LStatus_ErrID		WORD	

After these parameter settings are done, set Config_Ex to TRUE and then Mng_Open to TRUE. If the configuration need be modified during the communication, the input Config_Ex should be triggered on the rising edge, Mng_Open should be set to FALSE and then to TRUE after the new configuration data are set up.

- The node address of the slave DVP32ES2 is 1. The values in 31 bit devices %MX0.0~%MX3.6 of the master are written to Y0~Y30 in the slave. Then the values in Y0~Y30 of the slave are read and stored in the 31 bit devices %QX0.1~%QX3.7 in the master as shown in the following variable table 2.

➤ **Variable table 2**

Name	Address	Data type	Initial value
Mng		RS232_Link_Manage	
Mng_En		BOOL	TRUE
Mng_Open		BOOL	FALSE
Mng_Valid			
Mng_LOpen			
Config		RS232_Link_Config	
Config_Ex		BOOL	FALSE
Config_LN		UINT	1
Config_EL		BOOL	TRUE
Config_Ncyc		BOOL	FALSE
Config_SNI		USINT	1
Config_OT		USINT	1
Config_EFC17		BOOL	FALSE
Config_WBA	%MWO	UINT	
Config_WBAO		USINT	0
Config_WDA		UINT	16#0400
Config_WL		UINT	31
Config_RBA	%QW0	UINT	
Config_RBAO		USINT	1
Config_RDA		UINT	16#0400
Config_RL		UINT	31
Config_RFC		USINT	
Config_TOut		UINT	1000
Config_Done			
Config_Err			
Config_ErrID			
LStatus		RS232_Link_Status	
LStatus_En		BOOL	TRUE

Name	Address	Data type	Initial value
LStatus_LN		UINT	1
LStatus_Valid			
LStatus_RLE			
LStatus_RLEID			
LStatus_Err			
LStatus_ErrID			

➤ Program

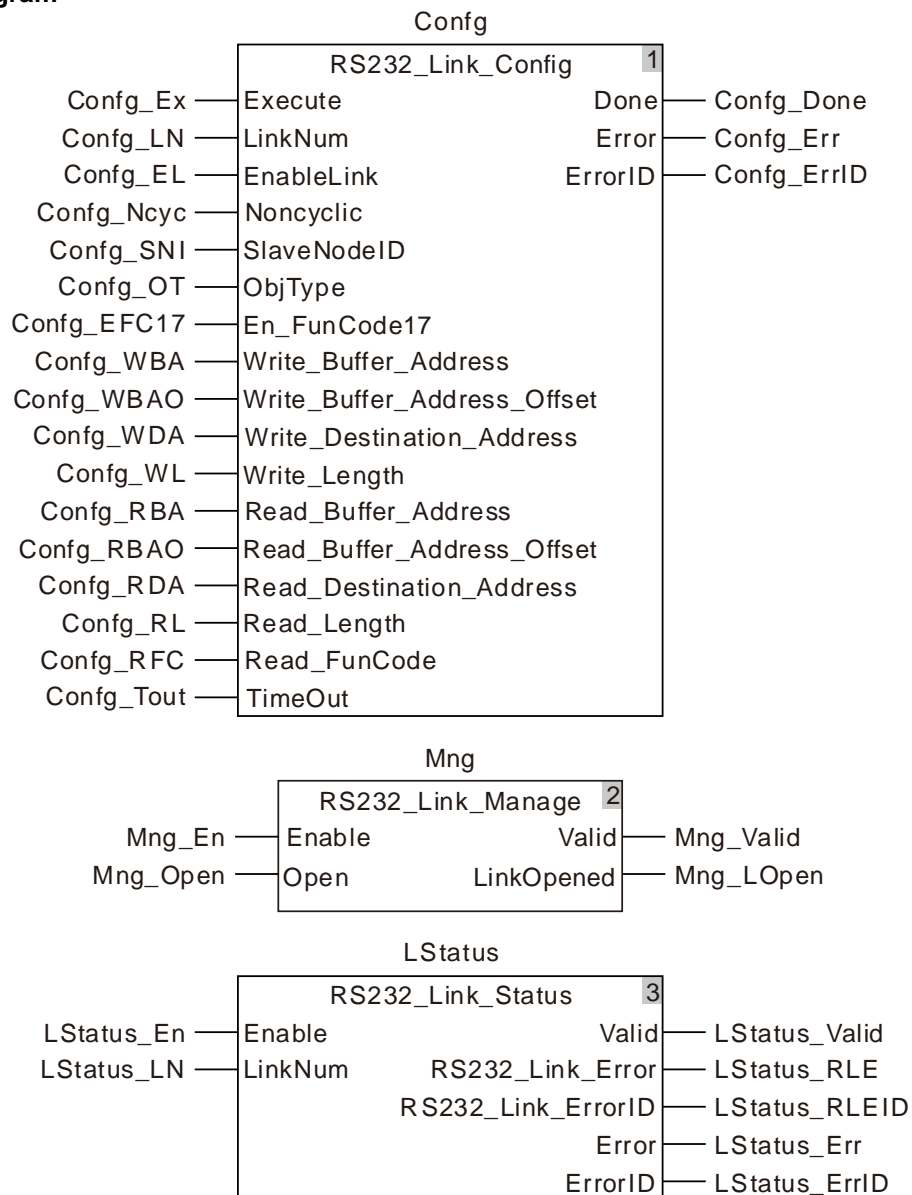

8.14.4.5 RS232_RS

FB/FC	Explanation	Applicable model
FB	RS232_RS is used to configure RS232 free protocol communication parameters for the motion controller.	DVP15MC11T DVP15MC11T-06

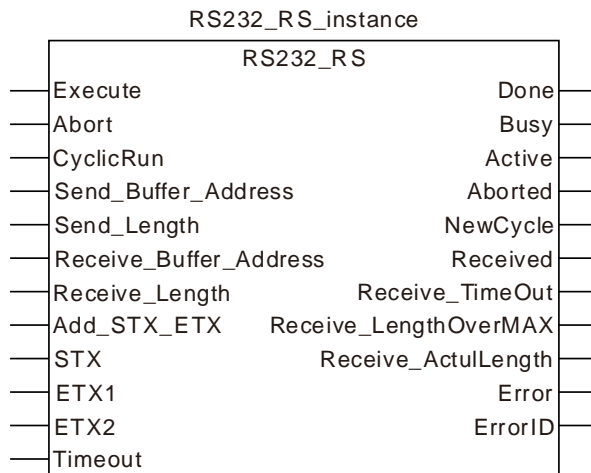

● **Input Parameters**

Parameter name	Function	Data type	Valid range (Default)	Validation timing
Execute	The instruction is executed when <i>Execute</i> changes from FALSE to TRUE.	BOOL	TRUE or FALSE (FALSE)	
Abort	The free protocol communication is aborted when <i>Abort</i> changes to TRUE.	BOOL	TRUE or FALSE (FALSE)	When <i>Execute</i> changes from FALSE to TRUE
CyclicRun	Communication mode setting for the instruction. FALSE: Non-cyclic; TRUE: Cyclic	BOOL	TRUE or FALSE (FALSE)	When <i>Execute</i> changes from FALSE to TRUE
Send_Buffer_Address	Specify the starting register of the master where the sent data are stored.	USINT	%MB0-%MB32767	When <i>Execute</i> changes from FALSE to TRUE
Send_length	Set the length of sent data.	UINT	0-200 (Byte) (0)	When <i>Execute</i> changes from FALSE to TRUE
Receive_Buffer_Address	Specify the starting register of the master where the received data are stored.	USINT	%MB0-%MB32767	When <i>Execute</i> changes from FALSE to TRUE
Receive_Length	Set the length of received data.	UINT	0-200(Byte) (0)	When <i>Execute</i> changes from FALSE to TRUE

Parameter name	Function	Data type	Valid range (Default)	Validation timing
Add_STX_ETX	Set if the start and end codes are added or not in sent messages. FALSE: Not add the start and end codes. TRUE: Add the start and end codes.	BOOL	TRUE or FALSE (FALSE)	When <i>Execute</i> changes from FALSE to TRUE
STX	Set the start of messages.	USINT	0-16#7F (16#3A)	When <i>Execute</i> changes from FALSE to TRUE
ETX1	Set the first end of messages.	USINT	0-16#7F (16#0D)	When <i>Execute</i> changes from FALSE to TRUE
ETX2	Set the second end of messages.	USINT	0-16#7F (16#0A)	When <i>Execute</i> changes from FALSE to TRUE
Timeout	Set the timeout time when receiving data.	UINT	0-32767 (0)	When <i>Execute</i> changes from FALSE to TRUE

- **Output Parameters**

Parameter name	Function	Data type	Valid range
Done	TRUE when the instruction execution is completed.	BOOL	TRUE / FALSE
Busy	TRUE when the communication proceeds.	BOOL	TRUE / FALSE
Aborted	TRUE when current execution of the instruction is aborted.	BOOL	TRUE / FALSE
Active	TRUE when the port is controlled by the instruction.	BOOL	TRUE / FALSE
NewCycle	TRUE when the instruction execution is completed once (in the multi-cycle state)	BOOL	TRUE / FALSE
Received	TRUE when receiving is successful.	BOOL	TRUE / FALSE
Receive_TimeOut	TRUE when timeout in message receiving occurs.	BOOL	TRUE / FALSE
Receive_LengthOverMAX	TRUE when the length of received data exceeds the max. length allowed.	BOOL	TRUE / FALSE
Receive_ActullLength	Actually received data length	UINT	0-200
Error	TRUE when an instruction configuration error occurs.	BOOL	TRUE / FALSE
ErrorID	Contains error codes when an error occurs in the instruction execution. Please refer to section 12.2 for the corresponding error code.	WORD	

● Output Update Timing

Parameter Name	Timing for changing to TRUE	Timing for changing to FALSE
Done	◆ After <i>Execute</i> changes from FALSE to TRUE and <i>Busy</i> changes to TRUE in the one single cycle work state	◆ When <i>Execute</i> changes from TRUE to FALSE in the single cycle work state.
Busy	◆ When <i>Execute</i> changes from FALSE to TRUE.	◆ When <i>Abort</i> changes to TRUE in the multi-cycle state. ◆ When <i>Done</i> changes to TRUE in the one-single-cycle state.
Aborted	◆ When <i>Abort</i> changes from FALSE to TRUE for the first time.	◆ When <i>Abort</i> changes from TRUE to FALSE. ◆ When <i>Execute</i> changes from TRUE to FALSE. ◆ When <i>Execute</i> is FALSE and <i>Abort</i> changes from FALSE to TRUE, <i>Aborted</i> changes to TRUE and one cycle later, changes to FALSE.
Active	◆ When <i>Execute</i> changes from FALSE to TRUE.	◆ When <i>Execute</i> changes from TRUE to FALSE ◆ When current instruction is aborted by another instruction in the multi-cycle state. ◆ When <i>Done</i> changes to TRUE in the one-single-cycle state.
NewCycle	◆ When the PLC completes one cycle of work in the multi-cycle state.	◆ When the instruction enters the next cycle for receiving and sending data.
Received	◆ When the instruction receives the response message.	◆ When the next cycle is entered after the instruction receives the response message.
Receive_TimeOut	◆ When the parameter configuration for receiving data has been done and the response message is not received within the set timeout time.	◆ When the response message is received.
Receive_LengthOverMAX	◆ When the length of actually received data is greater than the max. length allowed.	◆ When the length of received data is less than the max. length allowed.
Error	◆ When an error occurs in the instruction parameter configuration.	◆ When the instruction configuration data are correct.

● Output Update Timing Chart

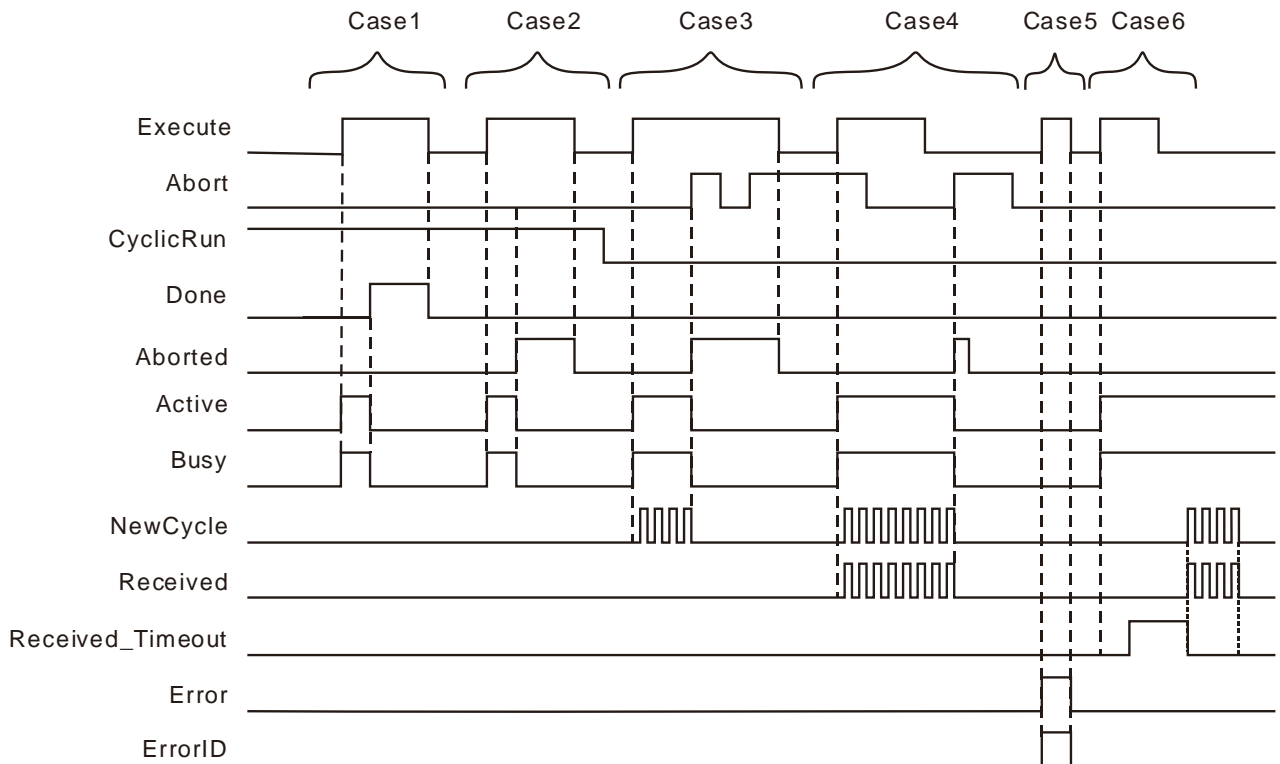

- Case 1 :** In the one-single-cycle work state, *Busy* changes to TRUE when *Execute* changes from FALSE to TRUE. When the instruction execution is completed, *Busy* changes to FALSE and *Done* changes to TRUE. When *Execute* changes to FALSE, *Done* changes to FALSE.
- Case 2 :** In the one-single-cycle work state, *Busy* and *Active* change to FALSE and *Abort* changes to TRUE when the instruction is aborted by other instruction. Then *Aborted* changes to FALSE when *Execute* changes to FALSE. If *Execute* changes to FALSE before the instruction is aborted, *Aborted* changes to TRUE for one cycle.
- Case 3 :** In the multi-cycle state where only the data-sending parameters are configured, when *Execute* changes from FALSE to TRUE, *Busy* changes to TRUE. After a while, *Newcycle* changes between TRUE and FALSE alternately. When *Abort* changes to TRUE, *Busy* changes to FALSE and *Aborted* to TRUE. When *Abort* changes to FALSE, *Aborted* remains TRUE. *Aborted* remains TRUE when *Abort* changes to TRUE again. *Aborted* changes to FALSE when *Execute* changes from TRUE to FALSE.
- Case 4 :** In the multi-cycle state where the parameters for receiving and sending data have been configured and *Abort* is TRUE, *Busy* changes to TRUE when *Execute* changes from FALSE to TRUE. After a while, both of *Newcycle* and *Received* begin to change between TRUE and FALSE alternately. When triggering *Abort* again after *Execute* changes from TRUE to FALSE, *Aborted* changes to TRUE, one cycle later, changes to FALSE and others change to FALSE.
- Case 5 :** If there is an error in the configured parameters of the instruction, *Error* changes to TRUE as *Execute* changes from FALSE to TRUE. *Error* changes to FALSE as *Execute* changes to FALSE.
- Case 6 :** In the event that the timeout of receiving data occurs, when *Execute* changes from FALSE to TRUE, *Busy* changes to TRUE and after a while, *Receive_Timeout* changes to TRUE. When the communication is restored to normal, both of *NewCycle* and *Received* start to change between TRUE and FALSE alternately.

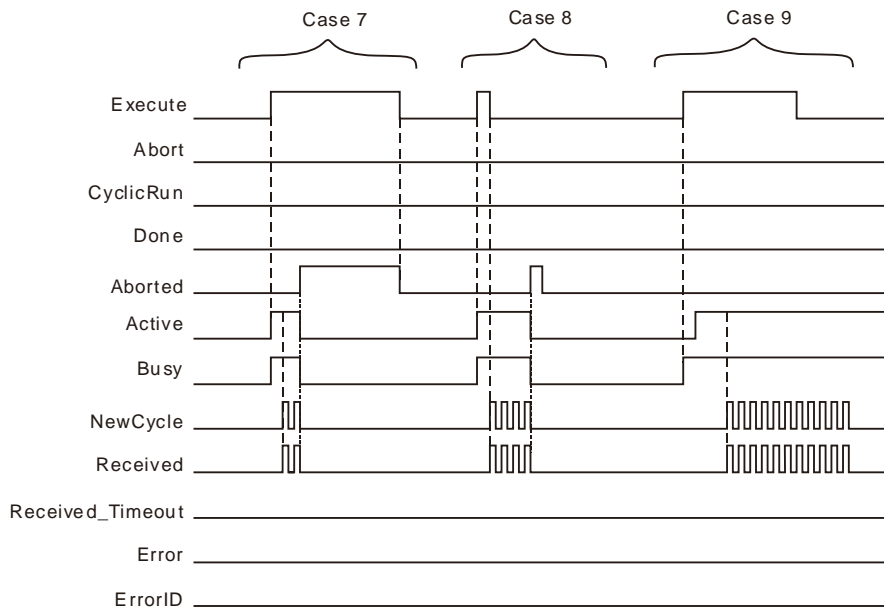

Case 7 : In the multi-cycle state where *Execute* is TRUE, when the instruction is aborted by other instruction, *Aborted* changes to TRUE, *Execute* changes to FALSE and *Aborted* changes to FALSE.

Case 8 : In the multi-cycle state where *Execute* is FALSE, when the instruction is aborted by other instruction, *Aborted* changes to TRUE and one cycle later, changes to FALSE.

Case 9 : When the instruction is aborted by other instruction, *Busy* changes to TRUE. After a while, *Active* changes to TRUE and other outputs give corresponding output according to the cases above.

● **Function**

RS232_RS is used to configure RS232 free protocol communication parameters and watch the communication status. The firmware of V1.01 and above supports the function.

● **Precaution**

1. RS232_RS does not add the checksum automatically. In ASCII mode, the data sent out are required to be the ASCII message which has been converted into.
2. The total length of sent data is 200 Bytes. The length set in the instruction does not include the start of end of messages.
3. Add_STX_ET sets if the header and footer codes are added or not in the sent message. The function is only enabled when the header and footer codes of the sent message are identical to those of the received message. Otherwise, the function can not be enabled if the header and footer codes of the sent message differ from those of the received message and in this case, an error will occur if the function is enabled.
 - a. The header code and footer code set in the instruction are for the sent messages. If the sent message is correct but the header code and footer code in the received message are different from those of the sent message, the controller will fail to receive the message and the timeout will happen during receiving.
 - b. The header code and footer code set in the instruction are for the sent message. So the slave will not give a response if the sent message does not conform to the slave message requirement. Thus, the function could not be enabled when the header and footer codes of the sent message are not identical to those of the received message.
4. When RS232_RS and RS_232_Link_Config exist together,
 - a. When *Execute* of RS232_RS instruction changes from FALSE to TRUE, the 232Link function of the PLC will take effect.
 - b. When *Abort* of RS232_RS instruction changes from FALSE to TRUE, the 232Link function which is being performed will take effect again.

- c. When *Execute* of RS232_RS instruction changes from FALSE to TRUE, *Enable* of RS232_Link_Manage changes to TRUE, *Open* of the instruction can control the functions of 232 link and free protocol communication.
- d. If there are several RS232_RS instructions in the program, only one of them, which is triggered the last time will take effect.
- e. For the message which is sent out via RS232_RS instruction, the address where received data are stored must be set in the RS232_RS instruction if the slave sends the response message.

8.14.4.6 RS232 Free Protocol Example



Programming Example 1

◆ **Enabling the function of the start and end of messages**

1. The free protocol is applied to send a standard Modbus message in ASCII mode with the starting address %MB4000 where sent data are stored and %MB5000 where received data are stored and receive the response data from the slave.

Message content: 01 10 15 00 00 01 02 00 08.

The checksum CF is calculated first. Then the message is converted into ASCII code.

Message content after conversion: 30 31 31 30 31 35 30 30 30 30 30 31 30 32 30 30 30 38 43 46.

2. If the parameters of RS232_RS instruction are configured based on variable table 1, the data in %MB4000~%MB4019 are 30 31 31 30 31 35 30 30 30 30 30 31 30 32 30 30 30 38 43 46.

The message data on the bus: 3A 30 31 31 30 31 35 30 30 30 30 30 31 30 32 30 30 30 38 43 46 0D 0A.

■ **Variable table 1**

Variable name	Address	Data type	Initial value
RS		RS232_RS	
RS_Ex		BOOL	FALSE
RS_Abort		BOOL	FALSE
RS_CyRun		BOOL	TRUE
RS_SBA	%MB4000	USINT	16#30
RS_SL		UINT	20
RS_RBA	%MB5000	USINT	
RS_RL		UINT	23
RS_AddSE		BOOL	1
RS_Tout		UINT	500
RS_Done		BOOL	
RS_Bsy		BOOL	
RS_Abt		BOOL	
RS_Act		BOOL	
RS_NCyc		BOOL	
RS_Rec		BOOL	
RS_RTO		BOOL	
RS_RLOM		BOOL	
RS_RAL		UINT	
RS_Err		BOOL	
RS_ErrID		WORD	

◆ **Disabling the function of the start and end of messages**

- a. The free protocol is applied to send a standard Modbus message in ASCII mode with the starting address %MB4000 where sent data are stored and %MB5000 where received data are stored and receive the response data from the slave.

Message content: 01 10 15 00 00 01 02 00 08.

The checksum CF is calculated first. Then the message is converted into ASCII code.

Message content after conversion: 3A 30 31 31 30 31 35 30 30 30 30 30 31 30 32 30 30 30 38 43 46 0D 0A

- b. If the parameters of RS232_RS instruction are configured based on variable table 2, the data in %MB4000~%MB4022 are 3A 30 31 31 30 31 35 30 30 30 30 30 31 30 32 30 30 30 38 43 46 0D 0A

The message data on the bus: 3A 30 31 31 30 31 35 30 30 30 30 30 31 30 32 30 30 30 38 43 46 0D 0A.

➤ **Variable table 2**

Variable name	Address	Data type	Initial value
RS		RS232_RS	
RS_Ex		BOOL	FALSE
RS_Abort		BOOL	FALSE
RS_CyRun		BOOL	TRUE
RS_SBA	%MB4000	USINT	16#3A
RS_SL		UINT	23
RS_RBA	%MB5000	USINT	
RS_RL		UINT	23
RS_AddSE		BOOL	0
RS_Tout		UINT	500
RS_Done		BOOL	
RS_Bsy		BOOL	
RS_Abt		BOOL	
RS_Act		BOOL	
RS_NCyc		BOOL	
RS_Rec		BOOL	
RS_RTO		BOOL	
RS_RLOM		BOOL	
RS_RAL		UINT	
RS_Err		BOOL	
RS_ErrID		WORD	

➤ **Program**

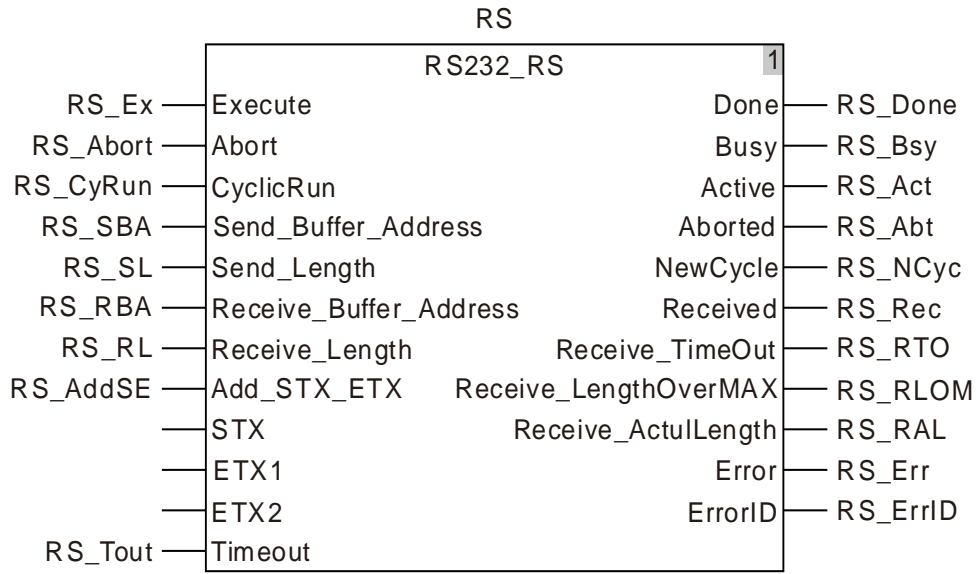

8.14.4.7 RS232_SetDelayTime

FB/FC	Explanation	Applicable model
FB	RS232_SetDelayTime sets the response-delay time at the RS485 communication port of the controller.	DVP15MC11T DVP15MC11T-06

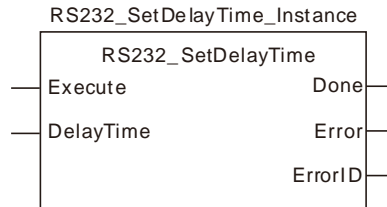

● Input Parameters

Parameter name	Function	Data type	Valid range (Default)	Validation timing
Execute	The instruction is executed when <i>Execute</i> changes from FALSE to TRUE.	BOOL	TRUE or FALSE (FALSE)	-
DelayTime	The response-delay time at the RS232 communication port of the controller. It is valid no matter whether the controller serves as a master or a slave. (Unit: ms)	UINT	0~65535 (0)	When <i>Execute</i> changes to TRUE

● Output Parameters

Parameter name	Function	Data type	Valid range
Done	TRUE when the instruction execution is completed.	BOOL	TRUE / FALSE
Error	TRUE when there is an error.	BOOL	TRUE / FALSE
Error ID	Contains error codes when an error occurs. Please refer to section 12.2 for the corresponding error code.	WORD	

● Output Update Timing

Parameter Name	Timing for changing to TRUE	Timing for changing to FALSE
Done	◆ When the instruction execution is completed.	◆ When <i>Execute</i> changes from TRUE to FALSE
Error	◆ When an error occurs in the instruction execution or the input parameters for the instruction are illegal.	◆ When <i>Execute</i> changes from TRUE to FALSE

● **Output Update Timing Chart**

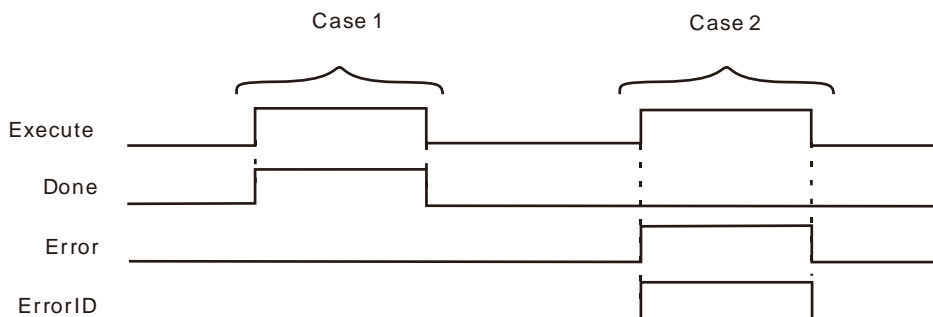

Case 1 : When *Execute* changes from FALSE to TRUE, *DONE* changes from FALSE to TRUE.

Case 2 : When an error occurs as *Execute* changes from FALSE to TRUE, *Error* changes to TRUE and *ErrorID* shows corresponding error codes. *Error* changes to FALSE when *Execute* changes from TRUE to FALSE.

● **Function**

The RS232_SetDelayTime instruction is used to set the response-delay time of the controller RS232 communication port. The setting time is valid when the RS232 communication port of the controller serves as a master or slave.

When RS232 communication port works as a master, it will not send a next message until the set delay time elapses after receiving the response data from the slave. When the RS232 communication port works as a slave, it will not reply to the master until the set delay time elapses after receiving the data from the master.

8.15 String Processing Instructions

8.15.1 CONCAT

FB/FC	Explanation	Applicable model
FC	CONCAT joins two or more string variables or constants together to form a new string.	DVP15MC11T DVP15MC11T-06

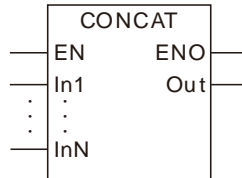

● Parameters

Parameter name	Meaning	Input/ Output	Description	Valid range
In1 to InN	Strings to join	Input	The joined parameter can be added or removed while the program is being written. The maximum number of joined parameters is 8 and the minimum number is 2. N=2~8.	Depends on the data type of the variable that the input parameter is connected to.
Out	Result of joining	Output	String resulted from joining	Depends on the data type of the variable that the output parameter is connected to.

	Boolean	Bit string					Integer						Real number		Time, date				String	
	BOOL	BYTE	WORD	DWORD	LWORD	USINT	UINT	UDINT	ULINT	SINT	INT	DINT	LINT	REAL	LREAL	TIME	DATE	TOD	DT	STRING
In1 to InN																				●
Out																				●

Note:

The symbol ● indicates that the parameter is allowed to connect to the variable or constant of the data type.

● **Function Explanation**

The CONCAT instruction joins two or more strings to form a new string and the new string is output to *Out*. The parameters from In1 to InN are joined in order as shown in the following figure.

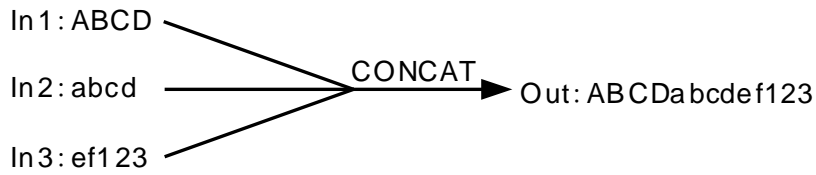

● **Precautions for Correct Use**

- The input variables are not allowed to omit. An error will occur during the compiling of the software if the input variables are omitted. But the output variable is allowed to omit.



Programming Example

- The data types of CONCAT_In1, CONCAT_In2 and Out1 are strings and the values of CONCAT_In1 and CONCAT_In2 are 'Asasz' and 'B1255' respectively. When CONCAT_EN is TRUE, the value of Out1 is 'AsaszB1255'.

➤ **The variable table and program**

Variable name	Data type	Current value
CONCAT_EN	BOOL	TRUE
CONCAT_In1	STRING	'Asasz'
CONCAT_In2	STRING	'B1255'
Out1	STRING	'AsaszB1255'

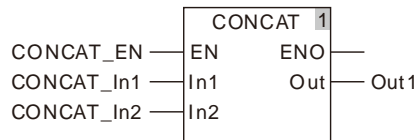

8.15.2 DELETE

FB/FC	Explanation	Applicable model
FC	DELETE deletes the specified-length string from the specified position from the string variable or constant.	DVP15MC11T DVP15MC11T-06

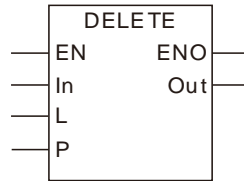

● Parameters

Parameter name	Meaning	Input/Output	Description	Valid range
In	String for deletion	Input	String for deletion	Depends on the data type of the variable that the input parameter is connected to.
L	Number of characters to delete	Input	Number of characters to delete	0~ maximum length of the string
P	Deletion start position	Input	Deletion start position	1~ maximum length of the string
Out	Deletion result	Output	String after deletion	Depends on the data type of the variable that the output parameter is connected to.

	Boolean	Bit string				Integer							Real number		Time, date			String			
	BOOL	BYTE	WORD	DWORD	LWORD	USINT	UINT	UDINT	ULINT	SINT	INT	DINT	LINT	REAL	LREAL	TIME	DATE	TOD	DT	STRING	
In																					●
L							●														
P							●														
Out																					●

Note:

The symbol ● indicates that the parameter is allowed to connect to the variable or constant of the data type.

● **Function Explanation**

- The DELETE instruction deletes L characters starting from the position specified by P of the In string and the characters after deletion will be output to Out. The deletion way is illustrated as below.

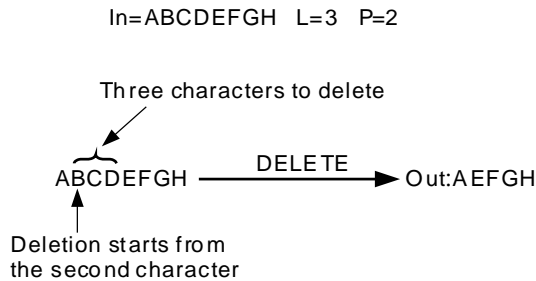

● **Precautions for Correct Use**

- The input variables are not allowed to omit. An error will occur during the compiling of the software if the input variables are omitted. But the output variable is allowed to omit.



Programming Example

- DELETE_In is 'AaBbCcDd', DELETE_L= 2 and DELETE_P = 3. When DELETE_EN is TRUE, Out1 is 'AaCcDd'.

➤ **The variable table and program**

Variable name	Data type	Current value
DELETE_EN	BOOL	TRUE
DELETE_In	STRING	'AaBbCcDd'
DELETE_L	UINT	2
DELETE_P	UINT	3
Out1	STRING	'AaCcDd'

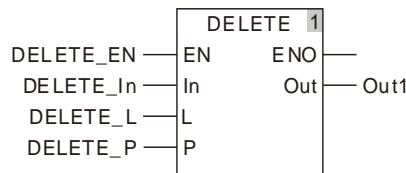

8.15.3 INSERT

FB/FC	Explanation	Applicable model
FC	INSERT inserts a string to the specified position in the string variable or constant.	DVP15MC11T DVP15MC11T-06

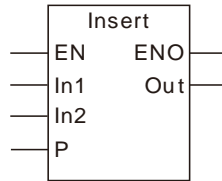

● Parameters

Parameter name	Meaning	Input/Output	Description	Valid range
In1	Original string	Input	Original string	Depends on the data type of the variable that the input parameter is connected to.
In2	String to insert	Input	String to insert	Depends on the data type of the variable that the input parameter is connected to.
P	Insertion start position	Input	Insertion start position	0~ maximum length of the string
Out	Insertion result	Output	Starting after insertion	Depends on the data type of the variable that the output parameter is connected to.

	Boolean	Bit string				Integer							Real number		Time, date			String				
	BOOL	BYTE	WORD	DWORD	LWORD	USINT	UINT	UDINT	ULINT	SINT	INT	DINT	LINT	REAL	LREAL	TIME	DATE	TOD	DT	STRING		
In1																					●	
In2																						●
P							●															
Out																						●

Note:

The symbol ● indicates that the parameter is allowed to connect to the variable or constant of the data type.

● **Function Explanation**

- The INSERT instruction inserts the *In2* string into the *In1* string and the new string is output to *Out*. The insertion position is between the position specified by *P* and the position specified by *P+1* of the characters in *In1*. If *P* =0, the *In2* string is inserted at the start of the *In1* string. The insertion way is illustrated as below.

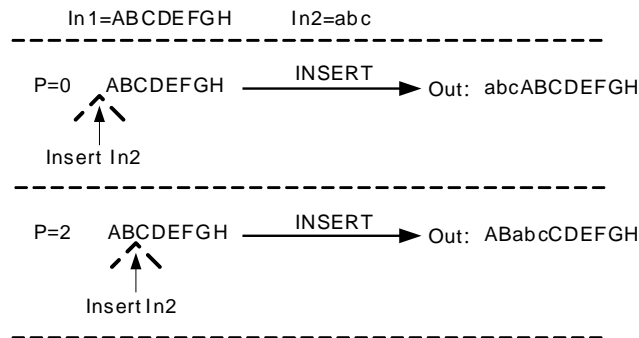

● **Precautions for Correct Use**

- The input variables are not allowed to omit. An error will occur during the compiling of the software if the input variables are omitted. But the output variable is allowed to omit.



Programming Example

- Insert_In1 is 'AaBbCcDd', Insert_In2 is 'Ee' and Insert_P=2. When Insert_EN is TRUE, Out1 is 'AaEeBbCcDd'.

➤ **The variable table and program**

Variable name	Data type	Current value
Insert_EN	BOOL	FALSE
Insert_In1	STRING	'AaBbCcDd'
Insert_In2	STRING	'Ee'
Insert_P	UINT	2
Out1	STRING	'AaEeBbCcDd'

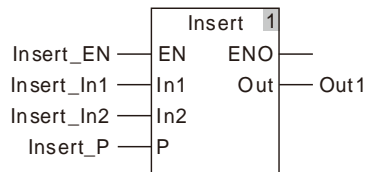

8.15.4 LEFT / RIGHT

FB/FC	Explanation	Applicable model
FC	LEFT/RIGHT extracts a specified-length string from the string variable or constant.	DVP15MC11T DVP15MC11T-06

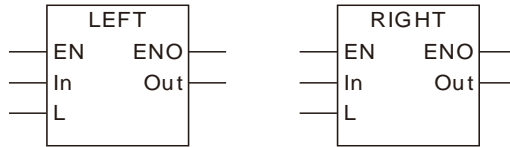

● Parameters

Parameter name	Meaning	Input/Output	Description	Valid range
In	Original string	Input	Original string	Depends on the data type of the variable that the input parameter is connected to.
L	Number of characters to get	Input	Number of characters to get	0~maximum number of characters
Out	Extraction result	Output	Extraction result	Depends on the data type of the variable that the output parameter is connected to.

	Boolean	Bit string				Integer							Real number		Time, date				String		
	BOOL	BYTE	WORD	DWORD	LWORD	USINT	UINT	UDINT	ULINT	SINT	INT	DINT	LINT	REAL	LREAL	TIME	DATE	TOD	DT	STRING	
In																					●
L							●														
Out																					●

Note:

The symbol ● indicates that the parameter is allowed to connect to the variable or constant of the data type.

● **Function Explanation**

- The LEFT/RIGHT instruction extracts a specified-length string from the string *In* and the extracted string is output to *Out*. The LEFT instruction extracts characters from the left of the string *In* and the RIGHT instruction extracts characters from the right of the string. The way of extracting characters is illustrated as below.

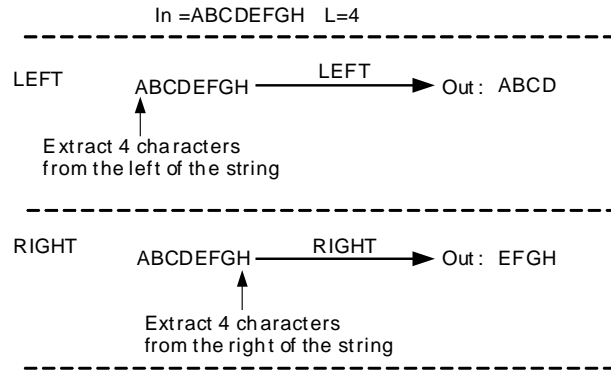

● **Precautions for Correct Use**

- The input variables are not allowed to omit. An error will occur during the compiling of the software if the input variables are omitted. But the output variable is allowed to omit.



Programming Example

- When the LEFT_In string is 'AaBbCcDd', LEFT_L=2 and LEFT_EN is TRUE, Out1 is 'Aa' as shown in the following table 1. When the RIGHT_In string is 'AaBbCcDd', RIGHT_L=2 and RIGHT_EN is TRUE, Out1 is 'Dd' as shown in the following table 2.

➤ **The variable table and program 1**

Variable name	Data type	Current value
LEFT_EN	BOOL	TRUE
LEFT_In	STRING	'AaBbCcDd'
LEFT_L	UINT	2
Out1	STRING	'Aa'

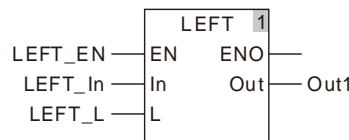

➤ **The variable table and program 2**

Variable name	Data type	Current value
RIGHT_EN	BOOL	TRUE
RIGHT_In	STRING	'AaBbCcDd'
RIGHT_L	UINT	2
Out1	STRING	'Dd'

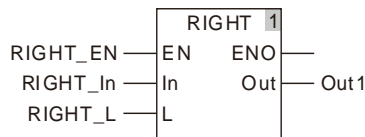

8.15.5 MID

FB/FC	Explanation	Applicable model
FC	MID extracts a specified-length string from the specified character position of a string variable or constant.	DVP15MC11T DVP15MC11T-06

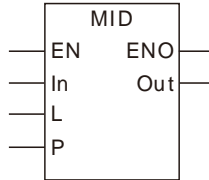

● Parameters

Parameter name	Meaning	Input/Output	Description	Valid range
In	Original string	Input	Original string	Depends on the data type of the variable that the input parameter is connected to.
L	Length of characters to extract	Input	Number of characters to extract	0~ maximum number of characters
P	Extraction start position	Input	Extraction start position	1~ maximum number of characters
Out	Extraction result	Output	Extraction result	Depends on the data type of the variable that the output parameter is connected to.

	Boolean	Bit string					Integer							Real number		Time, date				String
	BOOL	BYTE	WORD	DWORD	LWORD	USINT	UINT	UDINT	ULINT	SINT	INT	DINT	LINT	REAL	LREAL	TIME	DATE	TOD	DT	STRING
In																				●
L							●													
P							●													
Out																				●

Note:

The symbol ● indicates that the parameter is allowed to connect to the variable or constant of the data type.

● **Function Explanation**

- The MID instruction extracts *L* characters starting from the number-*P* character of the *In* string. The extracted string is output to *Out*. The extraction way is illustrated as below.

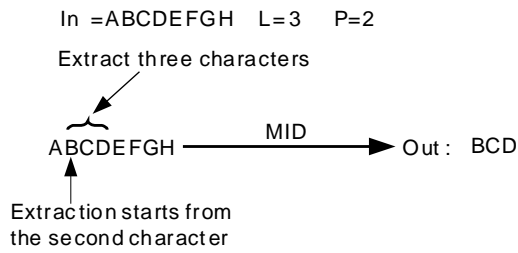

● **Precautions for Correct Use**

- The input variables are not allowed to omit. An error will occur during the compiling of the software if the input variables are omitted. But the output variable is allowed to omit.



Programming Example

- The MID_In string is 'AaBbCcDd', MID_L=2 and MID_LP=3. When MID_EN is TRUE, Out1 is 'Bb'.

➤ **The variable table and program**

Variable name	Data type	Current value
MID_EN	BOOL	TRUE
MID_In	STRING	'AaBbCcDd'
MID_L	UINT	2
MID_P	UINT	3
Out1	STRING	'Bb'

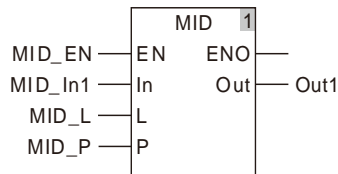

8.15.6 REPLACE

FB/FC	Explanation	Applicable model
FC	The REPLACE instruction replaces the specified-length string starting from the specified position with another string.	DVP15MC11T DVP15MC11T-06

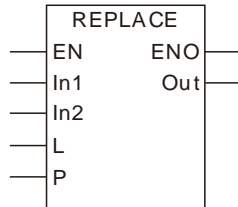

● Parameters

Parameter name	Meaning	Input/Output	Description	Valid range
In1	Original string	Input	Original string	Depends on the data type of the variable that the input parameter is connected to.
In2	Insert string	Input	String to insert	Depends on the data type of the variable that the input parameter is connected to.
L	Number of characters	Input	Number of characters to delete	0~ maximum number of characters
P	Replacement start position	Input	Replacement start position	1~ maximum number of characters
Out	Replacement result	Output	Replacement result	Depends on the data type of the variable that the output parameter is connected to.

	Boolean	Bit string				Integer							Real number		Time, date			String			
	BOOL	BYTE	WORD	DWORD	LWORD	USINT	UINT	UDINT	ULINT	SINT	INT	DINT	LINT	REAL	LREAL	TIME	DATE	TOD	DT	STRING	
In1																					●
In2																					●
L							●														
P							●														
Out																					●

Note:

The symbol ● indicates that the parameter is allowed to connect to the variable or constant of the data type.

● **Function Explanation**

The REPLACE instruction replaces L characters starting from the number-P character of the In1 string by inserting another string In2. And the replacement result is output to Out. The replacement process is illustrated as below.

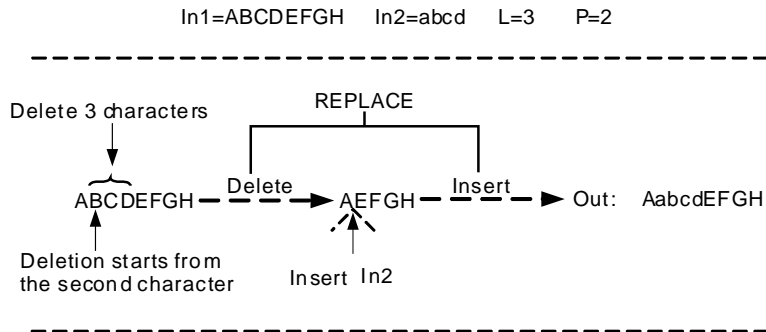

● **Precautions for Correct Use**

- The input variables are not allowed to omit. An error will occur during the compiling of the software if the input variables are omitted. But the output variable is allowed to omit.



Programming Example

- The REPLACE_In1 string is 'AaBbCcDd', the REPLACE_In2 string is 'DELTA', REPLACE_L=2 and REPLACE_LP=3. When REPLACE_EN is TRUE, Out1 is 'AaDELTAcCdd'.

➤ **The variable table and program**

Variable name	Data type	Current value
REPLACE_EN	BOOL	TRUE
REPLACE_In1	STRING	'AaBbCcDd'
REPLACE_In2	STRING	'DELTA'
REPLACE_L	UINT	2
REPLACE_P	UINT	3
Out1	STRING	'AaDELTAcCdd'

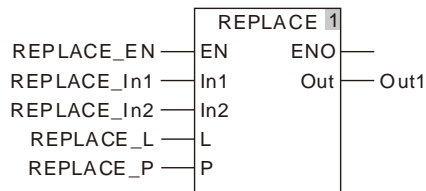

8.15.7 LEN

FB/FC	Explanation	Applicable model
FC	LEN calculates the number of characters in a string.	DVP15MC11T DVP15MC11T-06

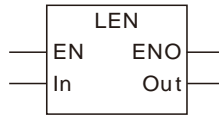

● Parameters

Parameter name	Meaning	Input/Output	Description	Valid range
In	String	Input	String	Depends on the data type of the variable that the input parameter is connected to.
Out	Number of characters	Output	Number of characters	Depends on the data type of the variable that the output parameter is connected to.

	Boolean	Bit string				Integer						Real number		Time, date				String		
	BOOL	BYTE	WORD	DWORD	LWORD	USINT	UINT	UDINT	ULINT	SINT	INT	DINT	LINT	REAL	LREAL	TIME	DATE	TOD	DT	STRING
In																				●
Out							●													

Note:

The symbol ● indicates that the parameter is allowed to connect to the variable or constant of the data type.

● Function Explanation

The LEN instruction finds the number of characters in a string and the result is output to *Out*. For example, when the string is ABCDEFGH, the value of *Out* is 8.

● Precautions for Correct Use

The input variables are not allowed to omit. An error will occur during the compiling of the software if the input variables are omitted. But the output variable is allowed to omit.



Programming Example

- The LEN_In string is 'AaBbCcDd'. As LEN_EN is TRUE, the value of Out1 is 8.

➤ The variable table and program

Variable name	Data type	Current value
LEN_EN	BOOL	TRUE
LEN_In	STRING	AaBbCcDd
Out1	UINT	8

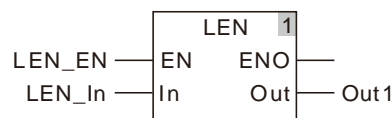

8.15.8 FIND

FB/FC	Explanation	Applicable model
FC	FIND searches for the position of a specified string in another string.	DVP15MC11T DVP15MC11T-06

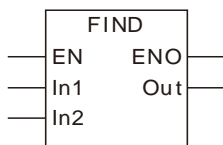

● **Parameters**

Parameter name	Meaning	Input/Output	Description	Valid range
In1	String	Input	String	Depends on the data type of the variable that the input parameter is connected to.
In2	Key characters to search for	Input	Key characters to search for	Depends on the data type of the variable that the input parameter is connected to.
Out	Number of characters	Output	Number of characters	Depends on the data type of the variable that the output parameter is connected to.

	Boolean	Bit string					Integer							Real number		Time, date				String
	BOOL	BYTE	WORD	DWORD	LWORD	USINT	UINT	UDINT	ULINT	SINT	INT	DINT	LINT	REAL	LREAL	TIME	DATE	TOD	DT	STRING
In1																				●
In2																				●
Out							●													

Note:

The symbol ● indicates that the parameter is allowed to connect to the variable or constant of the data type.

● **Function Explanation**

- The Find instruction takes the characters in *In2* as key characters and searches for the position of key characters in the string *In1*. For example, as *In1* is ABCDEFGH and *In2* is DE, the value of *Out* is 4.
- The search starts from the first character in the string *In1*.
- If multiple *In2* strings exist in *In1*, the value of *Out* is the position of the first *In2* from the beginning of *In1*.

- **Precautions for Correct Use**

The input variables are not allowed to omit. An error will occur during the compiling of the software if the input variables are omitted. But the output variable is allowed to omit.



- **Programming Example**

- The FIND_In1 string is 'AaBbCcDd' and the FIND_In2 string is 'Cc'. As FIND_EN is TRUE, the value of Out1 is 5.

- **The variable table and program**

Variable name	Data type	Current value
FIND_EN	BOOL	TRUE
FIND_In1	STRING	'AaBbCcDd'
FIND_In2	STRING	'Cc'
Out1	UINT	5

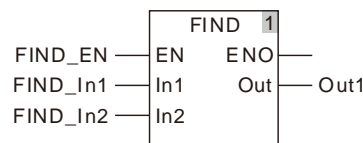

8.16 Immediate Refresh Instructions

8.16.1 FROM

FB/FC	Explanation	Applicable model
FB	The FROM instruction reads the values in CR registers of the left-side and right-side extension modules.	DVP15MC11T DVP15MC11T-06

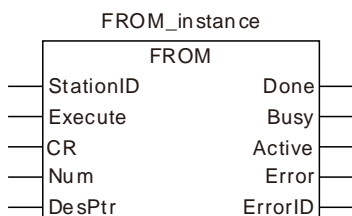

● Input Parameters

Parameter name	Function	Data type	Valid range (Default)	Validation timing
StationID	The position of the extension module connected to the left side or right side of the motion controller	USINT	Position range of left-side module: 100~107 Position range of right-side special module: 0~7 The position of the first module at the left side of the motion controller is 100 and the position of the first module at the right side of the motion controller is 0. (The variable value must be set)	When <i>Execute</i> changes from FALSE to TRUE
Execute	The instruction is executed when <i>Execute</i> changes from FALSE to TRUE.	BOOL	TRUE or FALSE (The variable value must be set)	-
CR	The number of the first CR (Controlled Register) to be read	UINT	0~max. CR number (The variable value must be set)	When <i>Execute</i> changes from FALSE to TRUE
Num	Number of CR registers which are to be read	USINT	1~64 (The variable value must be set)	When <i>Execute</i> changes from FALSE to TRUE
DesPtr	The CR values read by the instruction	INT or DINT	The range of the data type of the read CR value (The variable value must be set)	When <i>Execute</i> changes from FALSE to TRUE

● Output Parameters

Parameter name	Function	Data type	Valid range
Done	TRUE when the instruction execution is completed.	BOOL	TRUE / FALSE
Busy	TRUE when the instruction is being executed.	BOOL	TRUE / FALSE
Active	TRUE when the instruction is being executed.	BOOL	TRUE / FALSE
Error	TRUE while there is an error.	BOOL	TRUE / FALSE
ErrorID	Contains the error code when an error occurs. Please refer to section 12.2 for the corresponding error ID.	WORD	-

● Output Update Timing

Parameter Name	Timing for changing to TRUE	Timing for changing to FALSE
Done	◆ When the reading of the parameter values is finished.	◆ When <i>Execute</i> changes from TRUE to FALSE after the instruction execution is completed.
Busy	◆ When <i>Execute</i> changes to TRUE	◆ When <i>Done</i> changes from FALSE to TRUE ◆ When <i>Error</i> changes to TRUE.
Active	◆ When the instruction execution begins	◆ When <i>Error</i> changes to TRUE. ◆ When <i>Done</i> changes from FALSE to TRUE.
Error	◆ When an error occurs in the instruction execution or the input parameters for the instruction are illegal.	◆ When <i>Execute</i> changes from TRUE to FALSE

● Output Update Timing Chart

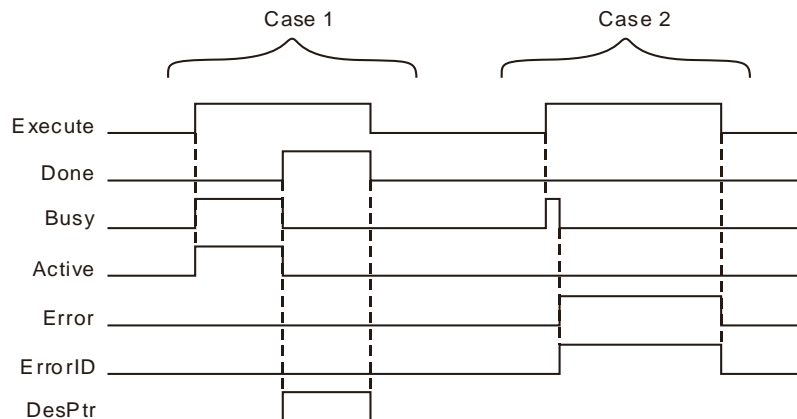

Case 1 : When *Execute* changes from FALSE to TRUE, *Busy* and *Active* change to TRUE and one period later, *Done* changes to TRUE. Meanwhile *Busy* and *Active* change to FALSE and *DesPtr* shows the corresponding data in CR registers of the extension module. When *Execute* changes from TRUE to FALSE, *Done* changes from TRUE to FALSE and the value of *DesPtr* is cleared to 0.

Case 2 : When an error occurs as *Execute* is TRUE, *Error* changes from FALSE to TRUE and *ErrorID* shows corresponding error codes. *Error* changes from TRUE to FALSE and the value in *ErrorID* is cleared to 0 after *Execute* changes from TRUE to FALSE.

● Function Explanation

The FROM instruction can be applied to read the values in the registers of the left-side and right-side extension modules.

The position of the left-side and right-side module is specified by *StationID*. The Station ID range of right-side module is 0~7. 0 represents the first extension analog module at the right side and 7 means the eight

extension analog module at the right side. The Station ID range of left-side modules is 100~107. 100 represents the first extension module at the left side and 107 means the eight extension module at the left side. If the Standard ID range exceeds the specified range of the left-side and right side module, an error will occur in the instruction execution.

If more than one CR register need be read by the instruction, the parameter *DesPtr* need be defined as the Nth element of an array. The data in the first CR register will be read to the Nth element of the array, the data in the second CR register will be read to the N+1th element and so on. By doing so, the data in multiple CR registers will be all read to the array. Refer to Programming Example 2 for details.

 **Precaution**

Maximum 8 extension modules are connectable to the left side and Maximum 8 special modules are connectable to the right side of the motion controller. Digital modules have no position number. For example, if DVP04AD-S, DVP16SP11T and DVP04DA-S are connected to the right side of the motion controller one after another, the *StationID* value of DVP04AD-S is 0 and the *StationID* value of DVP04DA-S is 1.

 **Programming Example**

■ **The variable table and program**

Variable name	Data type	Current value
FRM	FROM	
FRM_ID	USINT	0
FRM_Ex	BOOL	FALSE
FRM_CR	UINT	0
FRM_Num	USINT	1
FRM_DP	INT	
FRM_Done	BOOL	
FRM_Bsy	BOOL	
FRM_Act	BOOL	
FRM_Err	BOOL	
FRM_ErrID	WORD	

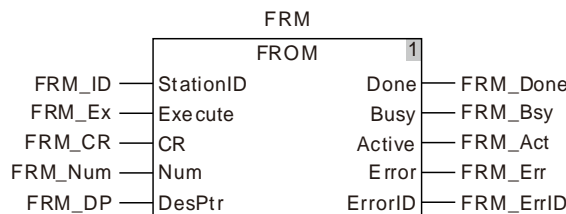

DVP-04AD is connected to the right side of the motion controller. When FRM_Ex changes from FALSE to TRUE and FRM_Bsy and FRM_Act change to TRUE simultaneously, FROM instruction starts to execute. When FRM_Done changes to TRUE, the instruction execution is finished. FRM_DP displays that the value in CR0 read by the instruction is 136 and thus the version of DVP-04AD is 1.36.

 **Programming Example**

■ **The variable table and program**

Variable name	Data type	Current value
FRM1	FROM	
FRM1_ID	USINT	0
FRM1_Ex1	BOOL	FALSE
FRM1_CR1	UINT	2
FRM1_Num1	USINT	4
FRM1_DP	Array[1..4] of INT	
FRM1_Done	BOOL	
FRM1_Bsy	BOOL	

Variable name	Data type	Current value
FRM1_Act	BOOL	
FRM1_Err	BOOL	
FRM1_ErrID	WORD	

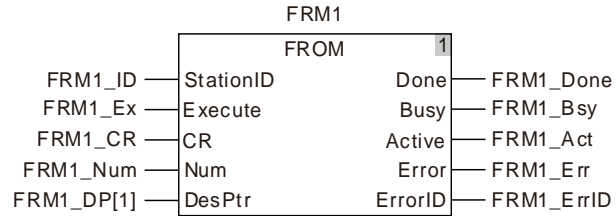

DVP-04AD is connected to the right side of the motion controller. When FRM1_Ex changes from FALSE to TRUE and FRM1_Bsy and FRM1_Act change to TRUE simultaneously, FROM instruction starts to execute. When FRM1_Done changes to TRUE, the instruction execution is finished. The values read from CR2, CR3, CR4 and CR5 are stored in the four elements FRM1_DP[1], FRM1_DP[2], FRM1_DP[3] and FRM1_DP[4] of the FRM1_DP array.

8.16.2 TO

FB/FC	Explanation	Applicable model
FB	The TO instruction writes data to the specified CR registers of the left-side module and right-side module.	DVP15MC11T DVP15MC11T-06

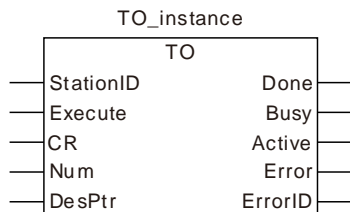

● Input Parameters

Parameter name	Function	Data type	Valid range (Default)	Validation timing
StationID	The position of the extension module connected to the left side or right side of the motion controller	USINT	Position range of left-side module: 100~107 Position range of right-side special module: 0~7 The position of the first module at the left side of the motion controller is 100 and the position of the first module at the right side of the motion controller is 0. (The variable value must be set)	When <i>Execute</i> changes from FALSE to TRUE
Execute	The instruction is executed when <i>Execute</i> changes from FALSE to TRUE.	BOOL	TRUE or FALSE (FALSE)	
CR	The number of the first CR (Controlled Register) to be read	UINT	0~ max. CR number (The variable value must be set)	When <i>Execute</i> changes from FALSE to TRUE
Num	Number of CR registers which are to be read	USINT	1~64 (The variable value must be set)	When <i>Execute</i> changes from FALSE to TRUE
DesPtr	The CR value written by the instruction	INT or DINT	The range of the data type of the written CR value (The variable value must be set)	When <i>Execute</i> changes from FALSE to TRUE

● Output Parameters

Parameter name	Function	Data type	Valid range
Done	TRUE when the instruction execution is completed.	BOOL	TRUE / FALSE
Busy	TRUE when the instruction is being executed.	BOOL	TRUE / FALSE
Active	TRUE when the instruction is being executed.	BOOL	TRUE / FALSE
Error	TRUE while there is an error.	BOOL	TRUE / FALSE
ErrorID	Contains the error code when an error occurs. Please refer to section 12.2 for the corresponding error ID.	WORD	-

● Output Update Timing

Parameter Name	Timing for changing to TRUE	Timing for changing to FALSE
Done	◆ When the writing of the parameter values is finished.	◆ When <i>Execute</i> changes from TRUE to FALSE after the instruction execution is completed
Busy	◆ When <i>Execute</i> changes to TRUE	◆ When <i>Done</i> changes from FALSE to TRUE ◆ When <i>Error</i> changes to TRUE.
Active	◆ When the instruction execution begins	◆ When <i>Error</i> changes to TRUE. ◆ When <i>Done</i> changes from FALSE to TRUE.
Error	◆ When an error occurs in the instruction execution or the input parameters for the instruction are illegal.	◆ When <i>Execute</i> changes from TRUE to FALSE.

● Output Update Timing Chart

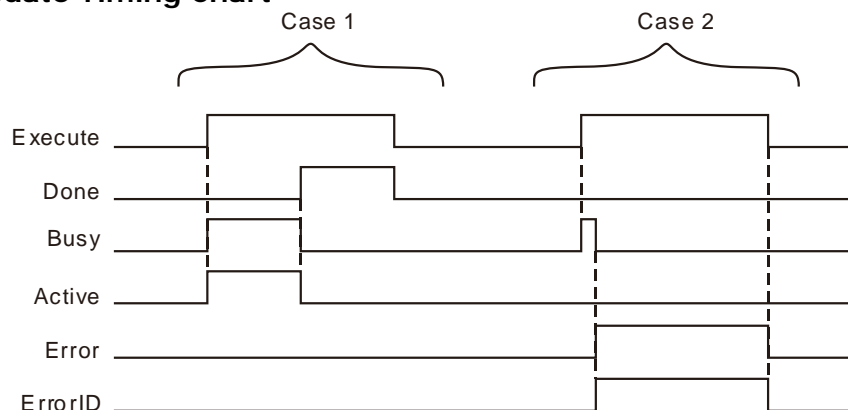

Case 1 : When *Execute* changes from FALSE to TRUE, *Busy* and *Active* change to TRUE. One period later, *Done* changes to TRUE. Meanwhile *Busy* and *Active* changes from TRUE to FALSE. After *Execute* changes from TRUE to FALSE, *Done* changes from TRUE to FALSE.

Case 2 : When an error occurs as *Execute* changes from FALSE to TRUE, *Error* changes from FALSE to TRUE and *ErrorID* shows corresponding error codes. *Error* changes from TRUE to FALSE and the value in *ErrorID* is cleared to 0 after *Execute* changes from TRUE to FALSE.

● Function Explanation

The TO instruction is used to write data to the specified CR registers of the left-side module and right-side module.

The positions of left-side and right-side modules are specified by *StationID*. The *StationID* range of right-side module is 0~7. 0 represents the first extension analog module at the right side. 7 is the eighth extension analog module at the right side. The *StationID* range of left-side module is 100~107. 100 is the first extension module at the left side. 107 is the eighth extension analog module at the left side. If *StationID* value exceeds the specified range for left-side and right-side modules, an error will occur in execution of the instruction.

If the instruction is used to write values to multiple CR registers, *DesPtr* need be defined as the Nth element

of the array. Then multiple values will be written to multiple CR registers by writing the Nth element value to the first CR, the N+1th element value to the second CR and so on after execution of the instruction. Refer to the following program examples for more details on the usage.

 **Precaution**

Maximum 8 extension modules are connectable to the left side and Maximum 8 special modules are connectable to the right side of the motion controller. The right-side digital modules have no position number. For example, if DVP04AD-S, DVP16SP11T and DVP04DA-S are connected to the right side of the motion controller one after another, the *StationID* value of DVP04AD-S is 0 and the *StationID* value of DVP04DA-S is 1.

 **Programming Example 1**

■ **The variable table and program**

Variable name	Data type	Current value
TO1	TO	
TO1_ID	USINT	0
TO1_Ex	BOOL	FALSE
TO1_CR	UINT	2
TO1_Num	USINT	1
TO1_DP	INT	10
TO1_Done	BOOL	
TO1_Bsy	BOOL	
TO1_Act	BOOL	
TO1_Err	BOOL	
TO1_ErrID	WORD	

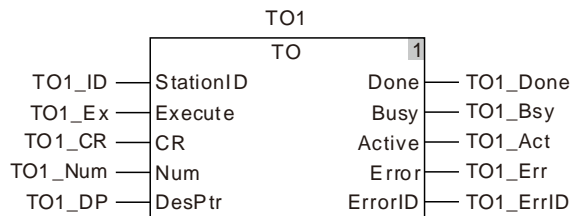

DVP-04AD is connected to the right side of the motion controller. When TO1_Ex changes from FALSE to TRUE, TO1_Bsy and TO1_Act change to TRUE simultaneously and the TO instruction execution starts. When TO1_Done changes to TRUE, the instruction execution is finished and the value which is written to CR2 in DVP-04AD is 10.

8

 **Programming Example 2**

■ **The variable table and program**

Variable name	Data type	Current value
TO2	TO	
TO2_ID	USINT	0
TO2_Ex	BOOL	FALSE
TO2_CR	UINT	2
TO2_Num	USINT	4
TO2_DP	Array[1..4] of INT	
TO2_Done	BOOL	
TO2_Bsy	BOOL	

Variable name	Data type	Current value
TO2_Act	BOOL	
TO2_Err	BOOL	
TO2_ErrID	WORD	

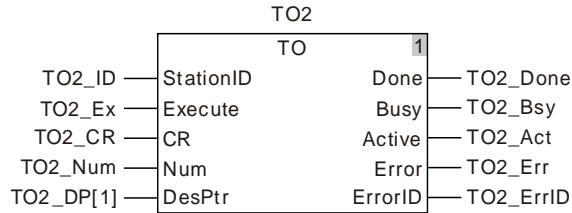

DVP-04AD is connected to the right side of the motion controller. When TO2_Ex changes from FALSE to TRUE, TO2_Bsy and TO2_Act change to TRUE simultaneously and the TO instruction execution starts. As TO2_Done changes to TRUE, the instruction execution is completed and the values written in CR2, CR3, CR4 and CR5 in DVP-04AD are the values written in the four elements TO2_DP[1], TO2_DP[2], TO2_DP[3] and TO2_DP[4] of the TO2_DP array respectively.

8.16.3 ImmediateInput

FB/FC	Explanation	Applicable model
FC	ImmediateInput is used for the immediate refresh of input points.	DVP15MC11T DVP15MC11T-06

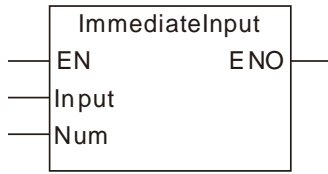

● **Parameters**

Parameter name	Meaning	Input/Output	Description	Valid range
Input	Start input point	Input	Start input point	0~15
Num	Number	Input	Number of input points for immediate refresh	1~16

	Boolean	Bit string					Integer						Real number		Time, date			String		
	BOOL	BYTE	WORD	DWORD	LWORD	USINT	UINT	UDINT	ULINT	SINT	INT	DINT	LINT	REAL	LREAL	TIME	DATE	TOD	DT	STRING
Input										●										
Num						●														

Note:

The symbol ● indicates that the parameter is allowed to connect to the variable or constant of the data type.

● **Function Explanation**

- The ImmediateInput instruction is used for refreshing external input point status to %IX0.0~%IX0.7 and %IX1.0~%IX1.7. If the ImmediateInput instruction does not exist, the controller refreshes external input point status to %IX0.0~%IX0.7 and %IX1.0~%IX1.7 once only every time the program scan starts.
- The *Input* parameter value 0~7 and 8~15 corresponds to %IX0.0~%IX0.7 and %IX1.0~%IX1.7. *Num* represents the quantity of consecutive devices starting from the one specified by *Input*. E.g. when *Input* value is 0 and *Num* is 2, it indicates that the external input point status is refreshed to %IX0.0 and %IX0.1.

● **Precautions for Correct Use**

- The instruction is only used for the immediate refresh of local input points instead of extension input points.



Programming Example

■ The variable table and program

Variable name	Data type	Current value
ImdInput_EN	BOOL	FALSE
ImdInput_Input	INT	2
ImdInput_NM	USINT	2
ImdInput_ENO	BOOL	

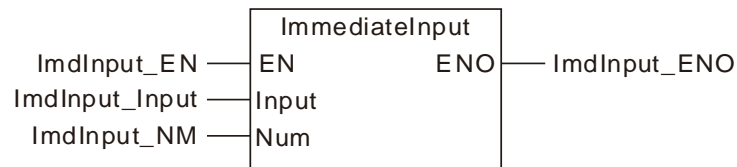

■ Program explanation

When the input variable ImdInput_EN is TRUE, the external hardware input points status will be refreshed to %IX0.2 and %IX0.3.

8.16.4 ImmediateOutput

FB/FC	Explanation	Applicable model
FC	ImmediateOutput is used for the immediate refresh of output points.	DVP15MC11T DVP15MC11T-06

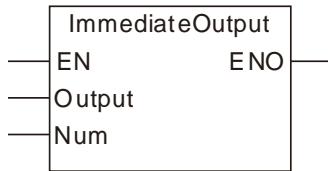

● **Parameters**

Parameter name	Meaning	Input/Output	Description	Valid range
Output	Start output point	Input	Start output point	0~7
Num	Number	Input	Number of output points for immediate refresh	1~8

	Boolean	Bit string					Integer						Real number		Time, date			String		
	BOOL	BYTE	WORD	DWORD	LWORD	USINT	UINT	UDINT	ULINT	SINT	INT	DINT	LINT	REAL	LREAL	TIME	DATE	TOD	DT	STRING
Output										●										
Num						●														

Note:

The symbol ● indicates that the parameter is allowed to connect to the variable or constant of the data type. °

● **Function Explanation**

- The ImmediateOutput instruction is used for refreshing current status of internal output point %QX0.0~%QX0.7 to external hardware output point. If the ImmediateOutput instruction does not exist, the controller refreshes internal output point status to external hardware output point. The status of %QX0.0~%QX0.7 is decided by other instructions. The ImmediateOutput instruction is only used for refreshing the status of %QX0.0~%QX0.7 to external hardware output points. The ImmediateOutput instruction does not control the TRUE or FALSE of %QX0.0~%QX0.7.
- The *Output* parameter value 0~7 of the ImmediateOutput instruction corresponds to %QX0.0~%QX0.7. *Num* represents the quantity of consecutive devices starting from the one specified by *Output*. E.g. when *Output* value is 0 and *Num* is 2, it indicates that the status of %QX0.0 and %QX0.1 is refreshed to the external hardware output point.

● **Precautions for Correct Use**

The instruction is only used for the immediate refresh of local output points instead of extension output points.



Programming Example

■ The variable table and program

Variable name	Data type	Current value
ImdOput_EN	BOOL	FALSE
ImdOput_Oput	INT	2
ImdOput_NM	USINT	2
ImdOput_ENO	BOOL	

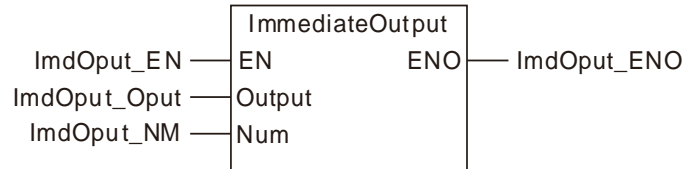

■ Program Explanation

When the input variable ImdOput_EN is TRUE, the status of %QX0.2 and %QX0.3 will be refreshed to the external hardware output point.

8.16.5 Left_Manage

FB/FC	Explanation	Applicable model
FB	The Left_Manage instruction is used to enable or disable the function of the left-side module device mapping.	DVP15MC11T DVP15MC11T-06

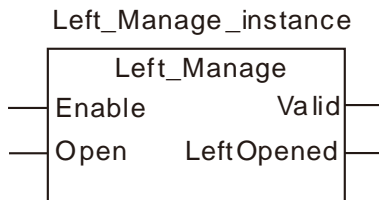

● Input Parameters

Parameter name	Function	Data type	Valid range (Default)	Validation timing
Enable	The instruction is executed when <i>Enable</i> changes from FALSE to TRUE.	BOOL	TRUE or FALSE (FALSE)	-
Open	Enable the function of the left-side module device mapping.	BOOL	TRUE or FALSE (FALSE)	When <i>Enable</i> changes to TRUE

● Output Parameters

Parameter name	Function	Data type	Valid range
Valid	TRUE when the output of the instruction is valid.	BOOL	TRUE / FALSE
LeftOpened	TRUE when the function of the left-side module device mapping is enabled.	BOOL	TRUE / FALSE

● Output Update Timing

Parameter Name	Timing for changing to TRUE	Timing for changing to FALSE
Valid	◆ When <i>Enable</i> changes to TRUE.	◆ When <i>Enable</i> changes from TRUE to FALSE
LinkOpened	◆ When <i>Enable</i> changes to TRUE and <i>Open</i> changes to TRUE.	◆ When <i>Enable</i> changes from TRUE to FALSE ◆ When <i>Open</i> changes from TRUE to FALSE

● Output Update Timing Chart

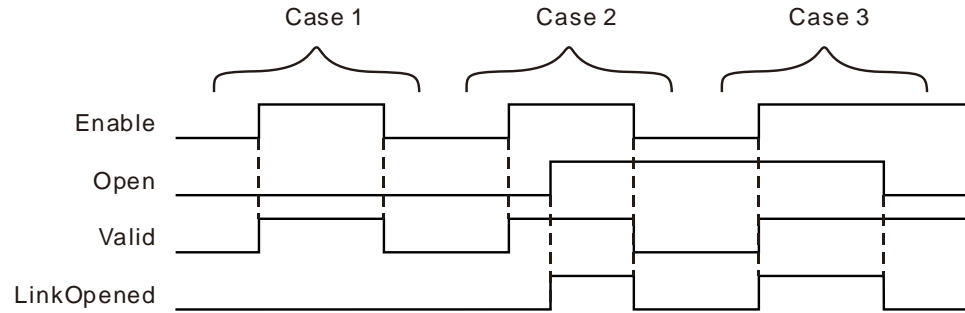

Case 1 : When *Enable* changes from FALSE to TRUE and *Open* is FALSE, *Valid* changes to TRUE and *LinkOpened* is FALSE.

Case 2 : In the situation that *Enable* changes from FALSE to TRUE and *Valid* changes to TRUE, *LinkOpened* changes to TRUE as *Open* changes from FALSE to TRUE. *Valid* and *LinkOpened* change to FALSE as *Enable* changes from TRUE to FALSE.

Case 3 : When *Open* is TRUE and *Enable* changes from FALSE to TRUE, *Valid* and *LinkOpened* change to TRUE. When *Open* changes to FALSE, *LinkOpened* changes to FALSE.

● Function

1. The firmware of V1.11 major version and above as well as that of V1.04 minor version and above support the instruction function.
2. When DVP04AD-SL and DVP04DA-SL modules are connected to the left side of DVP-50MC/15MC series motion controller, the Left_Manage instruction can be used to enable or disable the function of the left-side module device mapping. While *Enable* is TRUE, the function of the left-side module device mapping is turned ON if *Open* is TRUE. The function of the left-side module device mapping is turned OFF if *Open* is FALSE.
3. The function of the left-side module device mapping is disabled by default for one PLC. The function of the left-side module device mapping can not be used until the Left_Manage instruction is re-executed to enable the function after the function is enabled and the PLC is power ON again.
4. See the following input and output areas for the modules at different positions of the PLC when DVP-50MC/15MC series PLC connects modules at its left side. The position of the first module at the left-side of the PLC is 1 and the second one is 2 and so on. The positions of all modules at the left side of the PLC can be counted in order.

No matter whether the device mapping function is enabled or not by the instruction, the calculation method for the left-side module position is identical.
The mapping device area for AD modules is the input mapping area and the mapping device area for DA modules is the output mapping area

Mapping area Position	Output mapping area	Input mapping area
1	%MW6250~%MW6377	%MW6000~%MW6127
2	%MW6750~%MW6877	%MW6500~%MW6627
3	%MW7250~%MW7377	%MW7000~%MW7127

Mapping area Position	Output mapping area	Input mapping area
4	%MW7750~%MW7877	%MW7500~%MW7627
5	%MW8250~%MW8377	%MW8000~%MW8127
6	%MW8750~%MW8877	%MW8500~%MW8627
7	%MW9250~%MW9377	%MW9000~%MW9127
8	%MW9750~%MW9877	%MW9500~%MW9627

- When the device mapping function is enabled by the instruction, the corresponding CR registers of DVP04AD-SL and DVP04DA-SL modules are mapped to the input or output mapping area of the PLC. The CR registers of DVP04AD-SL and DVP04DA-SL modules are not mapped to the input or output mapping area of the PLC if the device mapping function is not enabled by the module and the values in the CR registers can be read or written via FROM or TO instruction.
No matter whether the device mapping function is enabled or not by the instruction, the input and output mapping areas for the network module (e.g. DVPPF02-SL) always exist.
- When the device mapping function is enabled by the instruction, CR12-CR19 registers of the DVP04AD-SL module is mapped to the first 8 Words of the input mapping area of the PLC. If DVP04AD-SL module is the first one on the left, the CR registers of the AD module correspond to the mapping areas of the PLC as shown in the following table. If the DVP04AD-SL module is the second one on the left, CR12-CR19 registers of the AD module are mapped to %MW6500-%MW6507 of the PLC. For the AD module located at other positions, the device mapping relationship can be calculated orderly in the same way.

AD module CR name	CR No.	Mapping device in the PLC
Channel 1 input signal mean value	CR12	%MW6000
Channel 2 input signal mean value	CR13	%MW6001
Channel 3 input signal mean value	CR14	%MW6002
Channel 4 input signal mean value	CR15	%MW6003
Channel 1 input signal present value	CR16	%MW6004
Channel 2 input signal present value	CR17	%MW6005
Channel 3 input signal present value	CR18	%MW6006
Channel 4 input signal present value	CR19	%MW6007

- When the device mapping function is enabled by the instruction, CR16-CR19 registers of the DVP04DA-SL module are mapped to the first 4 Words of the output mapping area of the PLC.
If DVP04DA-SL module is the first one on the left, the CR registers of the DA module correspond to the mapping areas of the PLC in the following table.
If the DVP04DA-SL module is the second one on the left, CR16-CR19 registers of the DA module are mapped to %MW6750-%MW6753 of the PLC. For the DA module located at other positions,

the device mapping relationship can be calculated orderly in the same way.

DA module CR name	CR No.	Mapping device in the PLC
Channel 1 output value	CR16	%MW6250
Channel 2 output value	CR17	%MW6251
Channel 3 output value	CR18	%MW6252
Channel 4 output value	CR19	%MW6253

8.17 PID-related Instructions

8.17.1 PID

FB/FC	Explanation	Applicable model
FB	The PID instruction is applicable for the PID operation.	DVP15MC11T DVP15MC11T-06

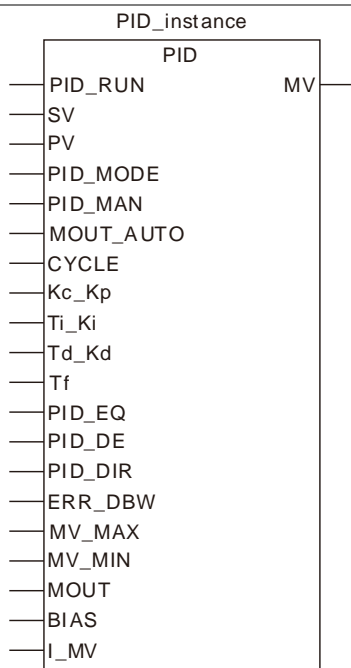

● Parameters

Parameter name	Meaning	Input/Output	Description	Valid range
PID_RUN	Enable PID operation	Input	Enable PID operation	TRUE or FALSE
SV	Target value	Input	Target value	-3.402823e+38 ~ -1.175495e-38 · 0 · +1.175495e-38 ~ +3.402823e+38
PV	Current value	Input	Current value	
PID_MODE	PID control mode	Input	0: Auto control, the output value (MV) is involved in the automatic operation. 1: Auto parameter-tuning function; when the tuning of the parameters is completed, the auto control mode is entered automatically (PID_MODE is set to 0) and appropriate parameters Kc_Kp, Ti_Ki, Td_Kd and Tf are filled.	0, 1
PID_MAN	PID A/M mode	Input	TRUE: Manual mode FALSE: Auto mode	TRUE or FALSE
MOUT_AUTO	Reserved	Input	-	-
CYCLE	Sampling time (Ts)	Input	Sampling time (Ts)	1~40,000 (Unit: ms)

Parameter name	Meaning	Input/Output	Description	Valid range
Kc_Kp	Proportional Coefficient	Input	Calculated proportional coefficient. If the P coefficient is less than 0, the Kc_Kp will be 0.	0 · +1.175495e-38 ~ +3.402823e+38
Ti_Ki	Integral coefficient	Input	If the calculated coefficient I is less than 0, Ti_Ki will be 0.	0 · +1.175495e-38 ~ +3.402823e+38 (Unit: Ti = sec; Ki = 1/sec)
Td_Kd	Derivative Coefficient	Input	If the calculated coefficient D is less than 0, Td_Kd will be 0.	0 · +1.175495e-38 ~ +3.402823e+38
Tf	Derivative-action time constant	Input	If the derivative-action time constant is less than 0, Tf will be 0	(Unit: sec)
PID_EQ	Reserved	Input	-	-
PID_DE	Reserved	Input	-	-
PID_DIR	PID forward/reverse direction	Input	TRUE: Positive direction (E=SV-PV) FALSE: Negative direction (E=PV-SV)	TRUE or FALSE
ERR_DBW	Range within which the error value is counted as 0	Input	Range within which the error value is counted as 0	-3.402823e+38 ~ -1.175495e-38 ·
MV_MAX	The upper limit of MV output value	Input	The upper limit of MV output value	0 ·
MV_MIN	The lower limit of MV output value	Input	The lower limit of MV output value	+1.175495e-38 ~ +3.402823e+38
MOUT	Manual output value	Input	Manual output value	
BIAS	Feedforward output value	Input	Feedforward output value	
I_MV	Reserved	Input	System parameter; DO not use it.	
MV	Output value	Output	MV value is between MV_MAX and MV_MIN.	-3.402823e+38 ~ -1.175495e-38 · 0 · +1.175495e-38 ~ +3.402823e+38

	Boolean	Bit string					Integer							Real number		Time, date				String	
	BOOL	BYTE	WORD	DWORD	LWORD	USINT	UINT	UDINT	ULINT	SINT	INT	DINT	LINT	REAL	LREAL	TIME	DATE	TOD	DT	STRING	
PID_RUN	●																				
SV														●							
PV														●							
PID_MODE											●										
PID_MAN	●																				
MOUT_AUTO	●																				
CYCLE											●										
Kc_Kp														●							
Ti_Ki														●							
Td_Kd														●							
Tf														●							
PID_EQ	●																				
PID_DE	●																				
PID_DIR	●																				
ERR_DBW														●							
MV_MAX														●							
MV_MIN														●							
MOUT														●							
BIAS														●							
I_MV														●							
MV														●							

Note:

The instruction is used to implement the PID operation. The PID operation is conducted only when PID instruction is performed by PLC. PID stands for Proportion, Integral and Derivative. The PID control is widely applied to mechanical equipment, pneumatic equipment and electronic equipment.

● **Function Explanation**

- There is no limit to how many times the instruction can be used. However, the variable specified by I_MV can not be used by other program repeatedly.
- PID instruction can only be used in the cyclic task.
- As long as PID is scanned, according to the sampling time specified by CYCLE, the PID operation is implemented and the MV value is output directly. The PLC will not calculate automatically

whether the scan time reaches the sampling time specified by *CYCLE* so as to output.

- The present value (PV) of PID must be a steady value before PID operation is performed. If the input values of special modules are to be captured for PID operation, users should notice the A/D conversion time of modules.
- When the PV value is in the range of **ERR_DBW**, at the beginning, the present error will be brought into the PID operation according to the normal processing and then the PLC module will check whether the present error meets the cross status condition: PV (process value) passes by the SV (target value). Once the condition is met, the present error will be counted as 0 for the PID operation. And after the PV value is out of the **ERR_DBW** range, the present error will be brought into the PID operation again.

If **PID_DE** is TRUE, that means using the the PV value to calculate the control value of the derivative and after the cross status condition is met, the PLC will treat ΔPV as 0 to implement the PID operation. ($\Delta PV = \text{current PV} - \text{previous PV}$). As the example shown below, the present error will be brought into the PID operation according to the normal processing in the section A and the present error or ΔPV will be counted as 0 to implement the PID operation in the section B.

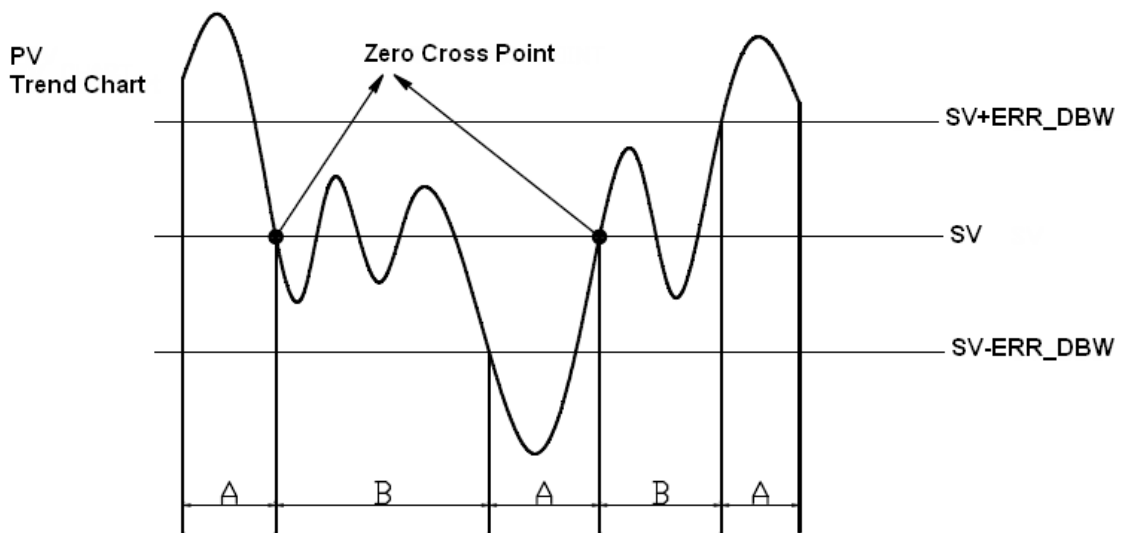

➤ PID Algorithm:

When **PID_MODE** is set to 0, the PID control mode is the automatic control mode

Independent Formula & Derivative of E (**PID_EQ=False & **PID_DE=False**)**

$$MV = K_p E + Ki \int_0^t E dt + K_d * \frac{dE}{dt} + BIAS \quad E = SV - PV \text{ or } E = PV - SV$$

When **PID_MODE** is set to 1, the PID control mode is the automatic tuning mode. After the tuning of the parameter is completed, **PID_MODE** becomes 0 automatically and the PID control mode becomes the automatic control mode

➤ **PID Block Diagram:**

PID Block Diagram (Independent)

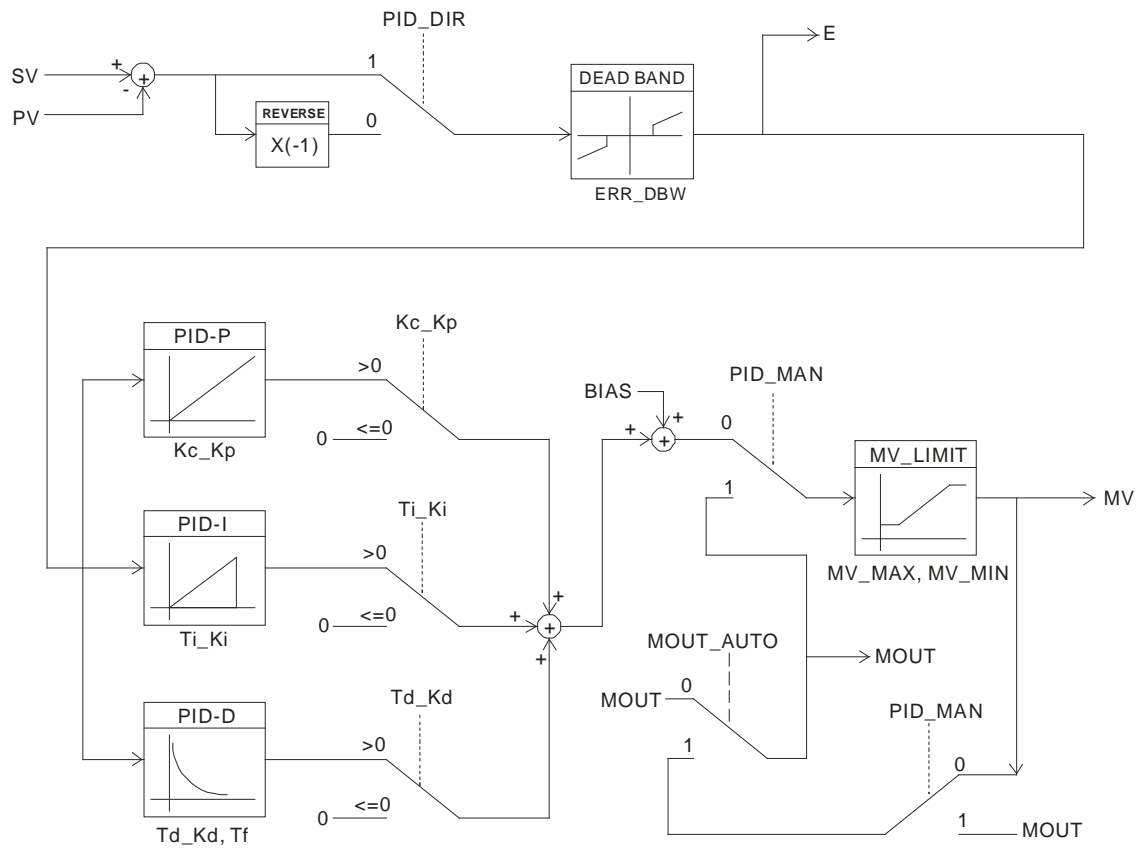

PID Block Diagram (Dependent)

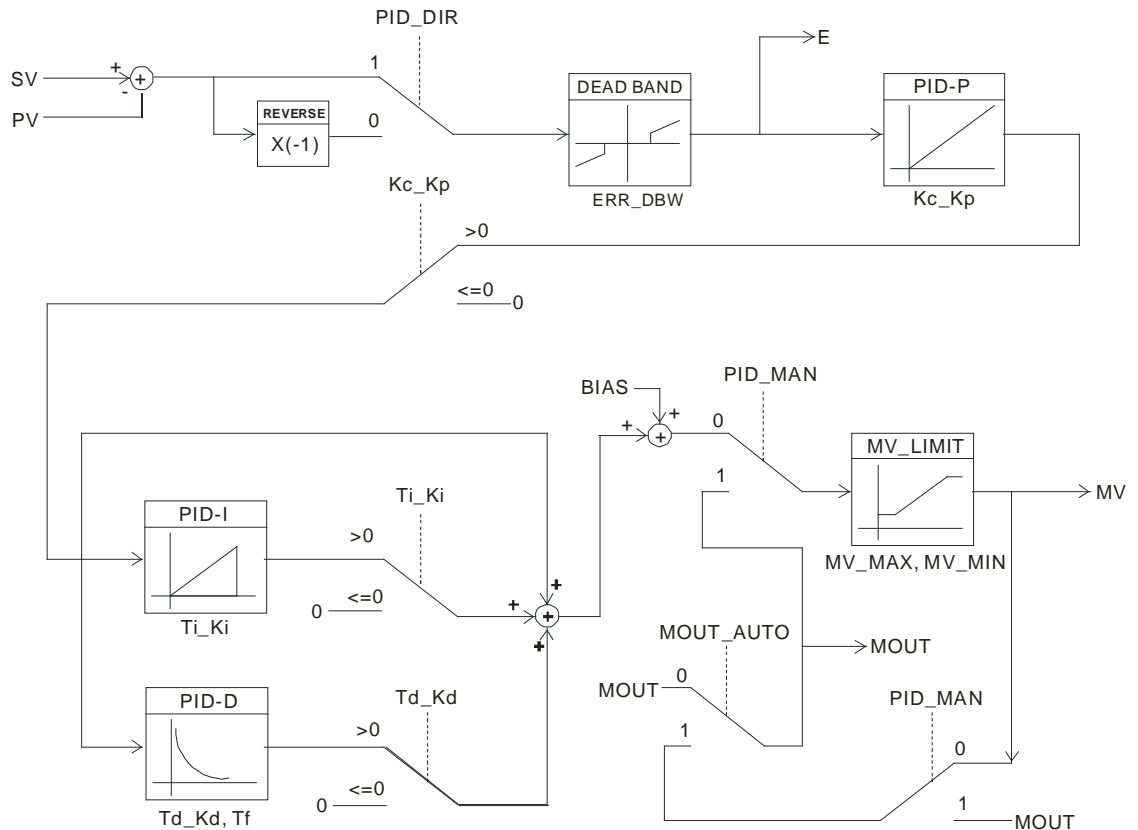

➤ **Precaution and Suggestion:**

Owing to the fact that the instruction PID can be used in a lot of controlled environments, users have to choose the control function appropriately. For example, to prevent the improper control from occurring, **PID_MODE** can not be used in the motor controlled environment because it is set to 1 and MV value is switched between MAX and MIN.

When users tune the parameters **Kc_Kp**, **Ti_Ki**, and **Td_Kd** (**PID_MODE** is set to 0), they have to tune **Kc_Kp** first (according to the experience), and then set the **Ti_Ki** and the **Td_Kd** to 0. When users can handle the control, they can increase **Ti_Ki** and the **Td_Kd**. When the **Kc_Kp** is 1, it means that the proportional gain is 100%. That is, the error value is increased by a factor of one. When the proportional gain is less than 100%, the error value is decreased. When the proportional gain is larger than 100%, the error value is increased.

To prevent the parameters which have been tuned automatically from disappearing after a power cut, we suggest users should store the parameters in the latched variables when **PID_MODE** =1 is selected. The parameters which have been tuned automatically are not necessarily suitable for every controlled environment. Therefore, users can modify the parameters which have been tuned automatically. However, it is suggested that users only modify the **Ti_Ki** and the **Td_Kd**.

The instruction should be used with many parameters. To prevent the improper control from occurring, please do not set the parameters randomly.

➤ **The steps of tuning the parameters used with the instruction PID**

Suppose that the transfer function of $G(s)$ the plant is the first-order function $G(s) = \frac{b}{s+a}$, the SV is

1, the sampling time *CYCLE* is 10 milliseconds. It is suggested that the steps of tuning the parameters are as follows.

Step 1: First, set the K_i and the K_d to 0. Next, set the K_p to 5, 10, 20 and 40 successively, and record the target values and the process values. The results are shown in the diagram below.

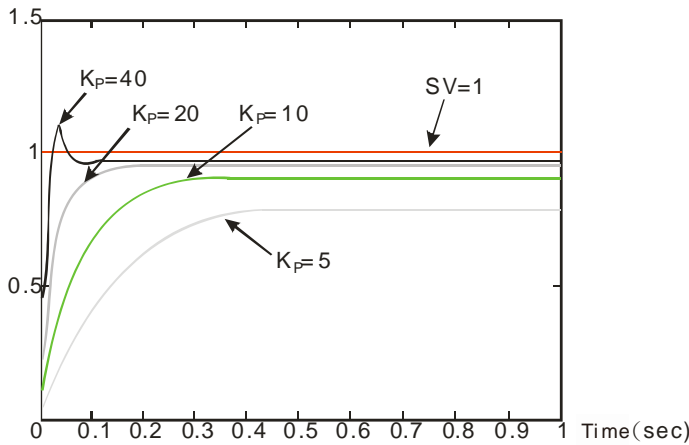

Step 2: When the K_p is 40, there is overreaction. Thus, the K_p is not chosen. When the K_p is 20, the reaction curve of the PV is close to the SV , and there is no overreaction. However, due to the fast start-up, the transient output value (MV) is very big. The K_p is not chosen, either. When the K_p is 10, the reaction curve of the PV approaches the SV smoothly. Therefore, the K_p is chosen. When the K_p is 5, the reaction is too slow. Thus, the K_p is not chosen.

Step 3: After the K_p is set to 10, increase the K_i . For example, the K_i is set to 1, 2, 4, and 8 successively. The K_i should not be larger than the K_p . Then, increase the K_d . For example, the K_d is set to 0.01, 0.05, 0.1, and 0.2 successively. The K_d should not be larger than ten percent of the K_p . Finally, the relation between the PV and the SV is presented in the following diagram.

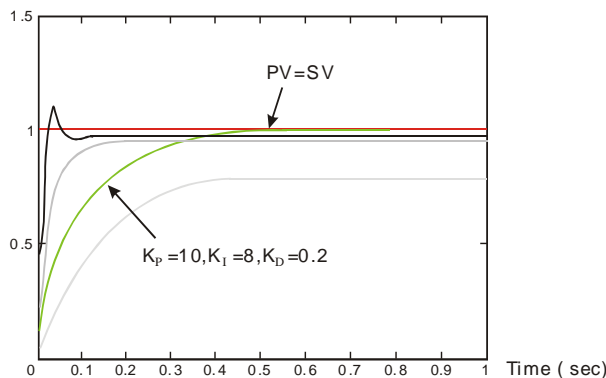

Note:

The example is only for reference. Users have to tune the parameters properly according to the practical condition of the control system

Programming Example

- Using the automatic tuning function to control the temperature
- Purpose: Using the automatic tuning function to calculate the most appropriate parameters for the PID temperature control
- Explanation:

Due to the fact that users may not be familiar with the characteristics of the temperature environment

which is controlled for the first time, they can use the automatic tuning function to make an initial adjustment (**PID_MODE** is set to 1). After the tuning of the parameter is complete, **PID_MODE** is set to 0. The controlled environment in this sample is an oven. The program example is as below

➤ **The variable table and program**

1. **Global variable table**

Variable name	Data type	Current value
M1	BOOL	FALSE
D_RUN	BOOL	
G_In1	INT	

2. **Local variable table**

Variable name	Data type	Current value
PID0	PID	
D_SV	REAL	
D_PV	REAL	
D_MODE	DINT	
D_MAN	BOOL	
D_CYC	DINT	
D_Kc	REAL	
D_Ki	REAL	
D_Kd	REAL	
D_Tf	REAL	
D_DIR	BOOL	
D_DBW	REAL	
D_MAX	REAL	
D_MIN	REAL	
D_MOUT	REAL	
D_BIAS	REAL	
D_I_MV	REAL	
D_MV	REAL	

3. The program

a. POU1 (Cyclic Task) :

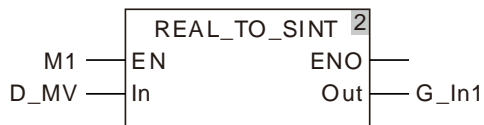
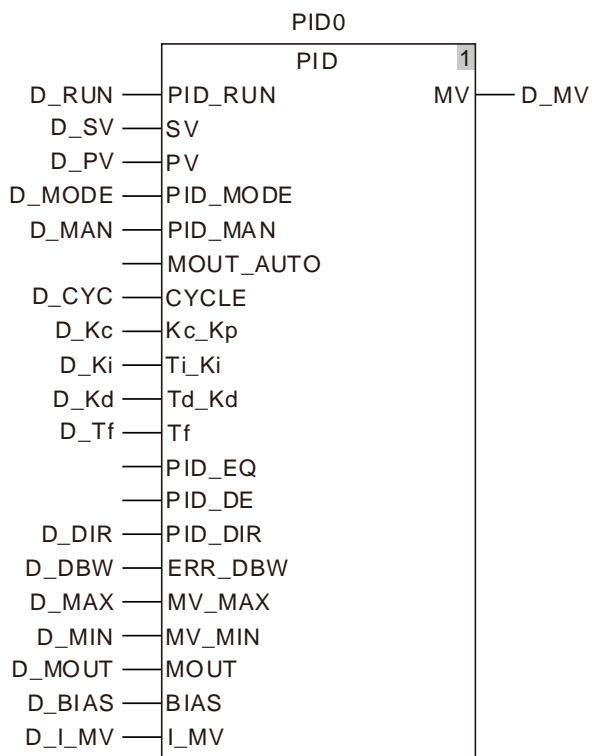

b. POU2 (Freewheeling Task) :

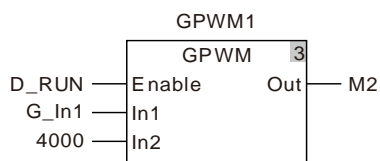

c. The experimental result of the automatic tuning function is shown below.

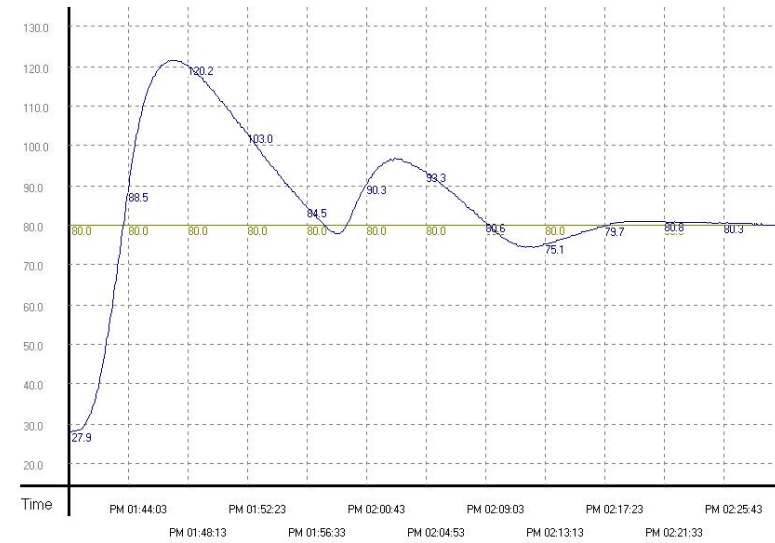

- d. The experimental result of using the parameters which have been tuned to control the temperature is shown below.

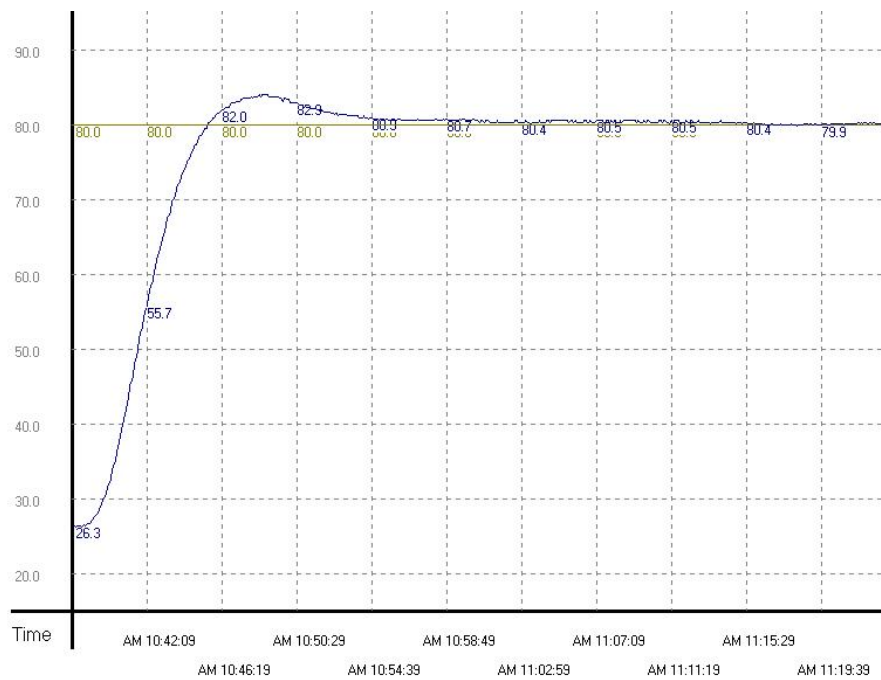

- e. As the diagram above shows, after the parameters are tuned automatically, users can get a good temperature control result. It only takes about twenty minutes to control the temperature. When the target temperature changes from 80°C to 100°C, the result is as below

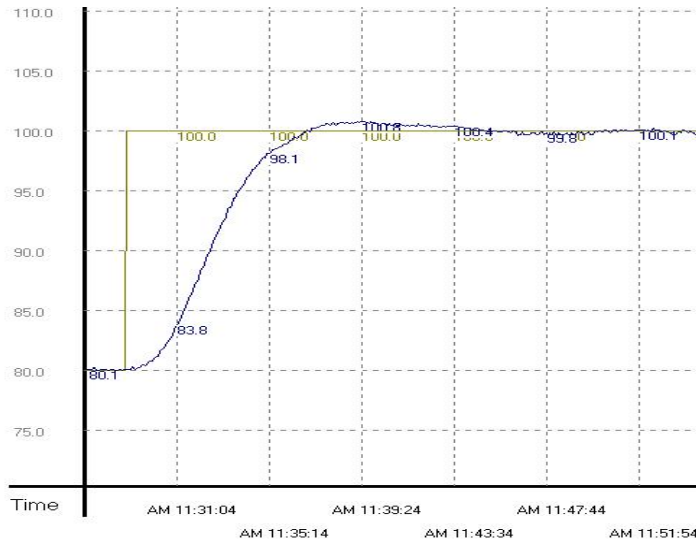

- f. As the diagram above shows, when the target temperature changes from 80°C to 100°C, the parameters tuned previously still can be used to control the temperature. Besides, it does not take much time to control the temperature.

8.17.2 GPWM

FB/FC	Explanation	Applicable model
FB	The GPWM instruction is used in the pulse output.	DVP15MC11T DVP15MC11T-06

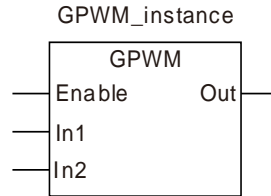

● Parameters

Parameter name	Meaning	Input/Output	Description	Valid range
Enable	Enable	Input	The instruction execution starts when <i>Enable</i> changes from FALSE to TRUE.	TRUE or FALSE
In1	The width of output pulse	Input	When the instruction is executed, set the width of output pulse (ms).	0~32767
In2	Output cycle of pulse	Input	When the instruction execution starts, set the cycle of output pulse (ms).	1~32767
Out	Register for outputting pulse	Output	The output is TRUE within the width of output pulse.	TRUE or FALSE

	Boolean	Bit string				Integer							Real number		Time, date				String		
	BOOL	BYTE	WORD	DWORD	LWORD	USINT	UINT	UDINT	ULINT	SINT	INT	DINT	LINT	REAL	LREAL	TIME	DATE	TOD	DT	STRING	
Enable	●																				
In1										●											
In2										●											
Out	●																				

Note:

The symbol ● indicates that the parameter is allowed to connect to the variable or constant of the data type.

● Function Explanation

- The GPWM instruction is used in the pulse output.
- Please use GPWM instruction in the freewheeling task. Otherwise the output of GPWM instruction may be inaccurate.
- The values of In1 and In2 can be modified while GPWM instruction is being executed.
- When $In1 \leq 0$, the pulse output register has no output. When $In1 \geq in2$, the pulse output register is always ON.
- The output of GPWM instruction can use a variable or any bit register. For details, refer to “Section 3.1.2 Registers and Data Types”.

Programming Example

■ **The variable table and program**

Variable name	Data type	Initial value
GPWM0	GPWM	
GPWM0_En	BOOL	FALSE
GPWM0_In1	INT	1000
GPWM0_In2	INT	2000

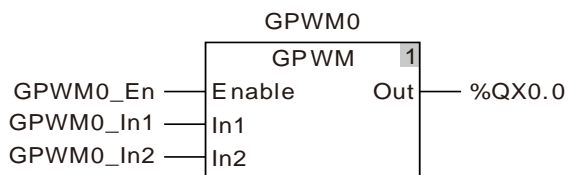

■ **Timing Chart**

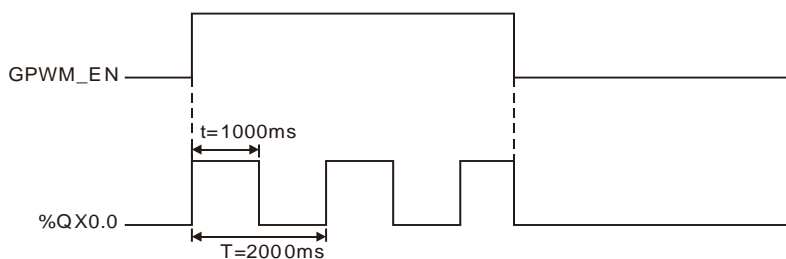

■ **Additional Explanation:**

When GPWM_EN changes to TRUE, the instruction works normally.
 When GPWM_EN changes to FALSE, the output of the instruction changes to FALSE.

8.18 Address Instruction

8.18.1 ADR

FB/FC	Explanation	Applicable model
FC	ADR is used to get the address of a variable.	DVP15MC11T DVP15MC11T-06

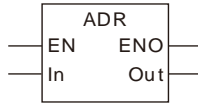

● Parameters

Parameter name	Meaning	Input/Output	Description	Valid range
In	Input value	Input	The variable of which the address is to be output	Depends on the data type of the variable that the input parameter is connected to.
Out	Operation result	Output	Output variable address of IN	Depends on the data type of the variable that the output parameter is connected to.

	Boolean	Bit string					Integer						Real number		Time, date				String	Pointer	
	BOOL	BYTE	WORD	DWORD	LWORD	USINT	UINT	UDINT	ULINT	SINT	INT	DINT	LINT	REAL	LREAL	TIME	DATE	TOD	DT	STRING	Pointer To xx
In	●	●	●	●	●	●	●	●	●	●	●	●	●	●	●	●	●	●	●	●	●
Out																					●

Note:

- The symbol ● indicates that the parameter is allowed to connect to the variable of the data type.
- The data type xx of 'Pointer To xx' must be the same as that of IN.

● Function Explanation

- The ADR instruction is used to get the address of a variable. Get the variable address and then find the value stored in the variable address by using the symbol ^.



Programming Example

- The ADR instruction is used to get the address of input variable ADR_In and place it in the output variable ADR1. The address of ADR_In is %MW0. After the ADR instruction is executed, ADR1 points to %MW0. After ADD is executed, ADR1 points to %MW1. ADR1^ means to get the value from the address of ADR1. (ADR1 value is %MW1 and ADR1^ means to get the value in %MW1.) The value in %MW1 is moved to the OUT1 variable through executing MOVE instruction.

➤ **The variable table and program**

Variable name	Address	Data type
ADR_EN		BOOL
ADR_In	%MW0	INT
ADR1		POINTER TO INT
OUT1		INT

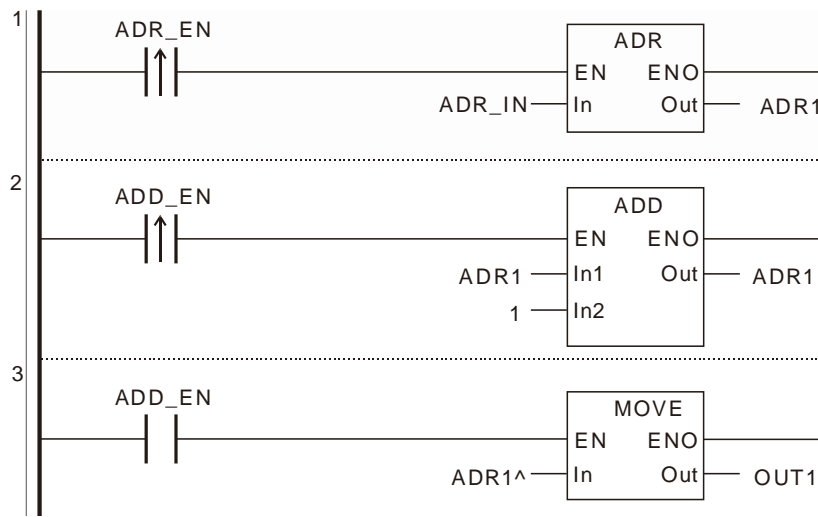

8.19 Network Diagnosis

8.19.1 Motion Diagnosis

8.19.1.1 CANmotion_SysDiag

FB/FC	Explanation	Applicable model
FB	CANmotion_SysDiag is used for the diagnosis of states of all slaves connected to Motion port.	DVP15MC11T DVP15MC11T-06

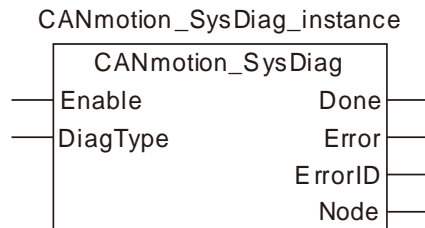

● Input Parameters

Parameter name	Function	Data type	Valid range (Default)	Validation timing
Enable	The instruction is executed when <i>Enable</i> changes from FALSE to TRUE.	BOOL	TRUE or FALSE (FALSE)	When <i>Enable</i> changes to TRUE.
DiagType	1: Whether axes are configured in the software. 2: Whether axes make connection with Motion port 3: Whether axes have released Emergency message.	USINT	1, 2, 3	When <i>Enable</i> changes to TRUE.

● Output Parameters

Parameter name	Function	Data type	Valid range
Done	TRUE when the instruction execution is completed.	BOOL	TRUE/FALSE
Error	TRUE when there is an error in the execution of the instruction.	BOOL	TRUE / FALSE
ErrorID	Contains the error code when an error occurs. Please refer to section 12.2.	WORD	
Node	Outputs corresponding states of all axes based on different values of <i>DiagType</i> .	Array[1..32]of BOOL	

● Output Update Timing

Name	Timing for changing to TRUE	Timing for changing to FALSE
Done	◆ When the instruction execution is completed.	◆ When <i>Error</i> changes to TRUE. ◆ When <i>Enable</i> changes to FALSE.
Error	◆ When an error occurs in the instruction execution or the input parameters for the instruction are illegal.	◆ When the error is cleared.

● Functions

CANmotion_SysDiag is used for the diagnosis of states of all slaves connected to Motion port. The instruction can only be applied to the Motion port built in the motion controller.

The output *Node* is an array of BOOL type for outputting the states of 1~32 axes. The value of *Node* has

different meaning when the value of the input *DiagType* varies.

When the value of the input *DiagType* is 1, the value of *Node* means whether axes are configured in the software. TRUE means that axes are configured in the software. FALSE means axes are not configured in the software.

When the value of the input *DiagType* is 2, the value of *Node* means whether axes make the connection with Motion port. TRUE means the connection is made. FALSE means the connection is not made.

When the value of the input *DiagType* is 3, the value of *Node* means whether axes release Emergency message. TRUE means Emergency message has been sent. FALSE means Emergency message has not been sent.

E.g. if the value of *DiagType* is 2 and the variable of the output *Node* is a, the value of a[1] is TRUE when axis 1 and Motion port make the connection and the value of a[1] is FALSE when the CANmotion cable of axis 1 is removed.



Programming Example

1. The variable table

Variable name	Data type	Initial value
CMSD	CANmotion_SysDiag	
CMSD_EN	BOOL	
CMSD_DT	USINT	2
CMSD_Node	ARRAY [1..32] OF BOOL	

2. The program

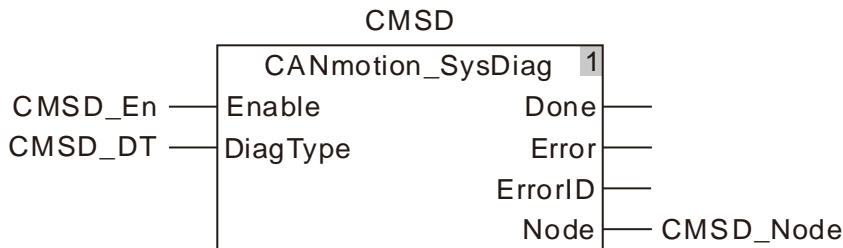

From the values of members of the *CMSD_Node* array, you can figure out if the corresponding axis is connected to Motion communication port of the controller or not.

If *CMSD_Node*[1]=1, it indicates that axis 1 and Motion communication port have been connected, if the *CMSD_Node*[1]=0, it indicates that axis 1 and Motion communication port have not been connected. The possible reason is that the communication cable between Motion communication port and axis 1 is not connected properly or the communication cable is unplugged after being plugged in.

For the connection of axis 2 to Motion communication port, you can use the value of *CMSD_Node*[2] to judge whether the connection is successful or not.

For the connection of other axes to Motion communication port, use the same way to judge whether the connection is successful or not.

8.19.1.2 CANmotion_NodeDiag

FB/FC	Explanation	Applicable model
FB	CANmotion_NodeDiag is used for the diagnosis of the state of the specified axis connected to Motion port.	DVP15MC11T DVP15MC11T-06

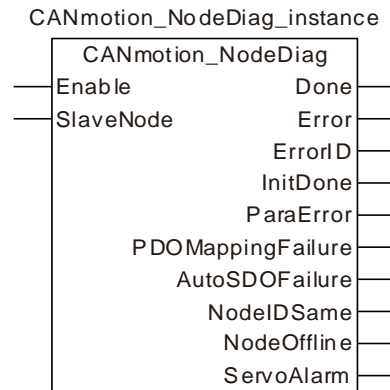

● Input Parameters

Parameter name	Function	Data type	Valid range (Default)	Validation timing
Enable	The instruction is executed when <i>Enable</i> changes from FALSE to TRUE.	BOOL	TRUE or FALSE (FALSE)	When <i>Enable</i> changes to TRUE.
SlaveNode	Number of the axis which is diagnosed.	USINT	1~32 (The variable value must be set)	When <i>Enable</i> changes to TRUE.

● Output Parameters

Parameter name	Function	Data type	Valid range
Done	TRUE when the instruction execution is completed.	BOOL	TRUE/FALSE
Error	TRUE when there is an error in the execution of the instruction.	BOOL	TRUE / FALSE
ErrorID	Contains the error code when an error occurs. Please refer to section 12.2.	WORD	
InitDone	TRUE when the slave axis initializing is finished.	BOOL	TRUE / FALSE
ParaError	TRUE when the key parameters of the slave axis are inconsistent.	BOOL	TRUE / FALSE
PDOMappingFailure	TRUE when the slave axis PDO mapping fails.	BOOL	TRUE / FALSE
AutoSDOFailure	TRUE when the setting for Auto SDO of the slave axis fails.	BOOL	TRUE / FALSE
NodeIDSame	TRUE when the station addresses of the master and slaves are duplicated.	BOOL	TRUE / FALSE
NodeOffLine	TRUE when the slave axis is offline.	BOOL	TRUE / FALSE
ServoAlarm	Records servo's alarm code.	UINT	

● Output Update Timing

Name	Timing for changing to TRUE	Timing for changing to FALSE
Done	◆ TRUE when the instruction execution succeeds.	◆ When <i>Error</i> changes to TRUE. ◆ When <i>Enable</i> changes to FALSE.

Name	Timing for changing to TRUE	Timing for changing to FALSE
Error	◆ When an error occurs in the instruction execution or the input parameters for the instruction are illegal.	◆ When the error is cleared.

- **Functions**

CANmotion_NodeDiag is used for the diagnosis of the state of the specified axis connected to Motion port. The instruction can only be applied to the Motion port built in the motion controller. If the axis configured in the software can not be used normally, the instruction can be used to diagnose the cause of an error for the axis.

8.19.2 CANopen Diagnosis

8.19.2.1 CANopen_SysDiag

FB/FC	Explanation	Applicable model
FB	CANopen_SysDiag is used for the diagnosis of the states of all slaves connected to CANopen port.	DVP15MC11T DVP15MC11T-06

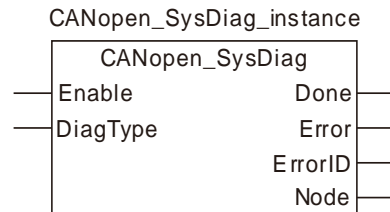

● Input Parameters

Parameter name	Function	Data type	Valid range (Default)	Validation timing
Enable	The instruction is executed when <i>Enable</i> changes from FALSE to TRUE.	BOOL	TRUE or FALSE (FALSE)	When <i>Enable</i> changes to TRUE.
DiagType	1: Whether slaves are configured in the software. 2: Whether slaves and CANopen port are made connection. 3: Whether slaves have released Emergency message.	USINT	1,2,3 (The variable value must be set)	When <i>Enable</i> changes to TRUE.

● Output Parameters

Parameter name	Function	Data type	Valid range
Done	TRUE when the instruction execution is completed.	BOOL	TRUE/FALSE
Error	TRUE when there is an error in the execution of the instruction.	BOOL	TRUE / FALSE
ErrorID	Contains the error code when an error occurs. Please refer to section 12.2.	WORD	
Node	Outputs corresponding states of all slaves based on different values of <i>DiagType</i> .	Array[1..32]of BOOL	

● Output Update Timing

Name	Timing for changing to TRUE	Timing for changing to FALSE
Done	◆ TRUE when the instruction execution succeeds.	◆ When <i>Error</i> changes to TRUE. ◆ When <i>Enable</i> changes to FALSE.
Error	◆ When an error occurs in the instruction execution or the input parameters for the instruction are illegal.	◆ When the error is cleared.

● Functions

CANopen_SysDiag is used for the diagnosis of the states of all slaves connected to CANopen port. (Only the CANopen port built in the motion controller can use the instruction.)

The output *Node* is an array of BOOL for outputting the states of 1~32 axes. The value of *Node* has

different meaning when the value of the input *DiagType* varies.

When the value of the input *DiagType* is 1, the value of *Node* means whether slaves are configured in the software. TRUE means that slaves are configured in the software. FALSE means slaves are not configured in the software.

When the value of the input *DiagType* is 2, the value of *Node* means whether slaves make the connection with CANopen port. TRUE means the connection is made. FALSE means the connection is not made.

When the value of the input *DiagType* is 3, the value of *Node* means whether slaves release Emergency message. TRUE means Emergency message has been sent. FALSE means Emergency message has not been sent.

E.g. if the value of *DiagType* is 2 and the variable of the output *Node* is a, the value of a[1] is TRUE when slave 1 and CANopen port make the connection and the value of a[1] is FALSE when the CANopen cable of slave 1 is removed.



Programming Example

1. The variable table

Variable name	Data type	Initial value
CSD	CANOpen_SysDiag	
CSD_EN	BOOL	
CSD_DT	USINT	2
CSD_Node	ARRAY [1..32] OF BOOL	

2. The program

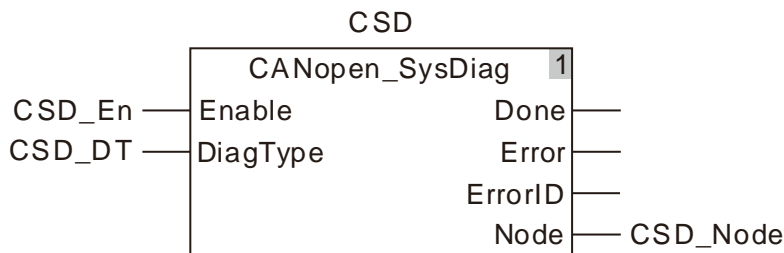

From the values of members of the CSD_Node array, you can figure out if the corresponding slave is connected to CANopen communication port of the controller or not.

If CSD_Node[1]=1, it indicates that axis 1 and CANopen communication port have been connected, if the CSD_Node[1]=0, it indicates that axis 1 and CANopen communication port have not been connected. The possible reason is that the communication cable between CANopen communication port and axis 1 is not connected properly or the communication cable is unplugged after being plugged in.

For the connection of axis 2 to CANopen communication port, you can use the value of CSD_Node[2] to judge whether the connection is successful or not.

For the connection of other axes to CANopen communication port, use the same way to judge whether the connection is successful or not.

8.19.2.2 CANopen_NodeDiag

FB/FC	Explanation	Applicable model
FB	CANopen_NodeDiag is used for the diagnosis of the state of the specified slave connected to CANopen port.	DVP15MC11T DVP15MC11T-06

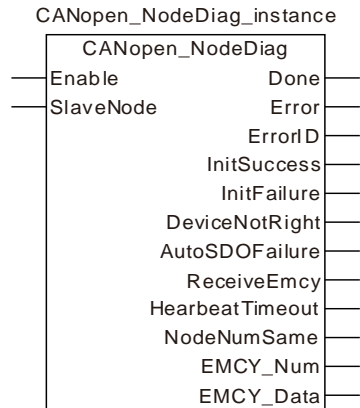

● Input Parameters

Parameter name	Function	Data type	Valid range (Default)	Validation timing
Enable	The instruction is executed when <i>Enable</i> changes from FALSE to TRUE.	BOOL	TRUE or FALSE (FALSE)	When <i>Enable</i> changes to TRUE.
SlaveNode		USINT	1~32 (The variable value must be set)	When <i>Enable</i> changes to TRUE.

● Output Parameters

Parameter name	Function	Data type	Valid range
Done	TRUE when the instruction execution is completed.	BOOL	TRUE/FALSE
Error	TRUE when there is an error in the execution of the instruction.	BOOL	TRUE / FALSE
ErrorID	Contains the error code when an error occurs. Please refer to section 12.2.	WORD	
InitSuccess	TRUE when the slave initializing succeeds.	BOOL	TRUE / FALSE
InitFailure	TRUE when the slave initializing fails.	BOOL	TRUE / FALSE
DeviceNotRight	TRUE when the slave register is incorrect.	BOOL	TRUE / FALSE
AutoSDOFailure	TRUE when the setting for Auto SDO of the slave fails.	BOOL	TRUE / FALSE
ReceiveEmcy	TRUE when the slave receives the Emergency message.	BOOL	TRUE / FALSE
HeartbeatTimeout	TRUE when the heartbeat message timeout occurs.	BOOL	TRUE / FALSE
NodeNumSame	TRUE when the station addresses of the master and slaves are duplicated.	BOOL	TRUE / FALSE
EMCY_Num	Records the number of Emergency message the controller receives.	USINT	0~5
EMCY_Data	Records the Emergency message that the controller receives from the slave.	ARRAY [1..5] OF CANopen_EMCY_Type	

● Output Update Timing

Name	Timing for changing to TRUE	Timing for changing to FALSE
Done	◆ When the instruction execution succeeds.	◆ When <i>Error</i> changes to TRUE. ◆ When <i>Enable</i> changes to FALSE.
Error	◆ When an error occurs in the instruction execution or the input parameters for the instruction are illegal.	◆ When the error is cleared.

● Functions

CANopen_NodeDiag is used for the diagnosis of the state of the specified slave connected to CANopen port. (Only the CANopen port built in the motion controller can use the instruction.) If the slave configured in the software can not work normally, the instruction can be used to diagnose the cause of the error and record the number of times the slave sends Emergency message and the Emergency message data.

8.19.2.3 CANopen_State

FB/FC	Explanation	Applicable model
FB	CANopen_State is used for the diagnosis of the state of CANopen port.	DVP15MC11T DVP15MC11T-06

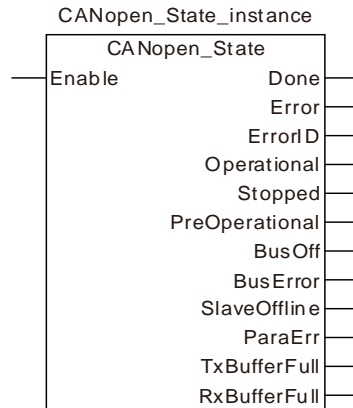

● Input Parameters

Parameter name	Function	Data type	Valid range (Default)	Validation timing
Enable	The instruction is executed when <i>Enable</i> changes from FALSE to TRUE.	BOOL	TRUE or FALSE (FALSE)	When <i>Enable</i> changes to TRUE.

● Output Parameters

Parameter name	Function	Data type	Valid range
Done	TRUE when the instruction execution is completed.	BOOL	TRUE/FALSE
Error	TRUE when there is an error in the execution of the instruction.	BOOL	TRUE / FALSE
ErrorID	Contains the error code when an error occurs. Please refer to section 12.2.	WORD	
Operational	TRUE when the master is in the operational state.	BOOL	TRUE / FALSE
Stopped	TRUE when the master is in Stop state.	BOOL	TRUE / FALSE
PreOperational	TRUE when the master is in the preoperational state.	BOOL	TRUE / FALSE
BusOff	TRUE when the bus interference is too strong or the products of different baud rates exist in the network.	BOOL	TRUE / FALSE
BusError	TRUE when the bus error occurs.	BOOL	TRUE / FALSE
SlaveOffline	TRUE when some slave is offline.	BOOL	TRUE / FALSE
ParaError	TRUE when the master and slave configuration parameter error occurs.	BOOL	TRUE / FALSE
TxBufferFull	TRUE when the buffer area for the master to send data is full.	BOOL	TRUE / FALSE
RxBufferFull	TRUE when the buffer area for the master to receive data is full.	BOOL	TRUE / FALSE

● Output Update Timing

Name	Timing for changing to TRUE	Timing for changing to FALSE
Done	◆ When the instruction execution succeeds.	◆ When <i>Error</i> changes to TRUE. ◆ When <i>Enable</i> changes to FALSE.
Error	◆ When an error occurs in the instruction execution or the input parameters for the instruction are illegal.	◆ When the error is cleared.

● Functions

CANopen_State is used for the diagnosis of the state of CANopen port (Only the CANopen port built in the motion controller can use the instruction.) It can tell the state of CANopen port and if any slave is offline.

8.20 Read and Write Offset Bit Value

8.20.1 SetBitOffsetValue

FB/FC	Explanation	Applicable model
FC	SetBitOffsetValue is used to set the value of the specific bit of the specified address to TRUE or FALSE.	DVP15MC11T DVP15MC11T-06

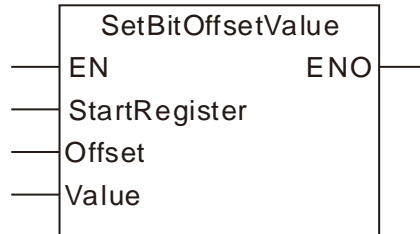

● Parameters

Parameter name	Meaning	Input/Output	Description	Valid range
StartRegister	Starting address	Input	Specify the starting address	
Offset	How many bits are offset	Input	Specify the offset value by regarding the bit0 of the variable that <i>StartRegister</i> points to as the reference.	0~1023
Value	Input value	Input	Input a specified bit value	TRUE / FALSE

	Boolean	Bit string				Integer							Real number		Time, date				Pointer		
	BOOL	BYTE	WORD	DWORD	LWORD	USINT	UINT	UDINT	ULINT	SINT	INT	DINT	LINT	REAL	LREAL	TIME	DATE	TOD	DT	Pointer To XX	
StartRegister																					●
Offset			●				●														
Value	●																				

Note:

- The symbol ● indicates that the parameter is allowed to connect to the variable or constant of the data type.
- xx of the 'Pointer To xx' data type includes Bit string and Integer data types.

● **Function Explanation**

The SetBitOffsetValue instruction is used to set the value of the specific bit of the specified address to TRUE or FALSE. The *StartRegister* parameter is a Pointer-type variable. The *Offset* parameter specifies the offset value which regards the bit0 of the variable the *StartRegister* parameter points to as the reference. The *Value* parameter shows the setting value of the specified bit, which is TRUE or FALSE. The bit which is specified by *StartRegister* and *Offset* together can be set to TRUE or FALSE through this instruction.

If the specified offset value exceeds the range of the starting address of *StartRegister*, the operation will be performed according to the corresponding offset address which regards the *StartRegister* as the starting address.

See more in the following example.

● **Precautions for Correct Use**

The *StartRegister* parameter of the SetBitOffsetValue instruction is a Pointer-type variable and needs to use the ADR instruction to gain the address.



Programming Example

■ **The variable table and program**

Variable name	Device address	Data type	Present value
SetBOV_EN		BOOL	TRUE
SetBOV_StartR	%MW0	UINT	
SetBOV_Offset		UINT	
SetBOV_Value		BOOL	

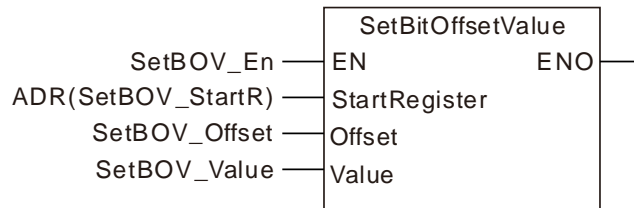

■ **Program Explanation**

When the SetBOV_EN variable is TRUE, set the value of the specified bit to the value of SetBOV_Value by changing the values of SetBOV_Offset and SetBOV_Value variables.

See the explanation below.

1. When SetBOV_Value is set to FALSE and the value of SetBOV_Offset is 2, the value of Bit2 of SetBOV_StartR (%MW0) is FALSE.
2. When SetBOV_Value is set to TRUE and the value of SetBOV_Offset is 2, the value of Bit2 of SetBOV_StartR (%MW0) is TRUE.
3. When SetBOV_Value is set to FALSE and the value of SetBOV_Offset is 16 (which regards Bit0 of the variable that StartRegister points to as the reference bit), the value of Bit1 of %MW1 is FALSE.
4. When SetBOV_Value is set to TRUE and the value of SetBOV_Offset is 16 (which regards Bit0 of the variable that StartRegister points to as the reference bit), the value of Bit1 of %MW1 is TRUE.

8.20.2 GetBitOffsetValue

FB/FC	Explanation	Applicable model
FC	GetBitOffsetValue is used to read the value of the specific bit of the specified address and display it in the output parameter.	DVP15MC11T DVP15MC11T-06

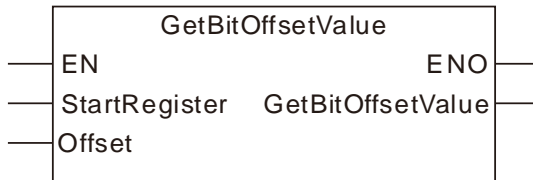

● **Parameters**

Parameter name	Meaning	Input/ Output	Description	Valid range
StartRegister	Starting address	Input	Specify the starting address	
Offset	How many bits are offset	Input	Specify the offset value by regarding the bit0 of the variable that <i>StartRegister</i> points to as the reference	0~1023
GetBitOffsetValue	The read bit value	Output	The read bit value	TRUE / FALSE

	Boolean	Bit string					Integer						Real number		Time, date			Pointer		
	BOOL	BYTE	WORD	DWORD	LWORD	USINT	UINT	UDINT	ULINT	SINT	INT	DINT	LINT	REAL	LREAL	TIME	DATE	TOD	DT	Pointer To XX
StartRegister																				●
Offset			●				●													
GetBitOffsetValue	●																			

Note:

1. The symbol ● indicates that the parameter is allowed to connect to the variable or constant of the data type.
2. xx of the 'Pointer To xx' data type includes Bit string and Integer data types.

● **Function Explanation**

The *GetBitOffsetValue* instruction is used to read the value of the specified bit and the output *GetBitOffsetValue* shows the read state value. The *StartRegister* parameter is a Pointer-type variable. The *Offset* parameter specifies the offset value which regards the bit0 of the variable the *StartRegister* parameter points to as the reference. The *GetBitOffsetValue* parameter shows the state value of the specified bit, which is TRUE or FALSE.

If the specified offset value exceeds the range of the starting address of *StartRegister*, the operation will be performed according to the corresponding offset address which regards the *StartRegister* as the starting address.

See more in the following example.

● **Precautions for Correct Use**

The *StartRegister* parameter of the GetBitOffsetValue instruction is a Pointer-type variable and needs to use the ADR instruction to gain the address.



Programming Example

■ **The variable table and program**

Variable name	Device address	Data type	Present value
SetBOV_EN		BOOL	
SetBOV_StartR	%MW5	UINT	
SetBOV_Offset		USINT	
GBOValue		BOOL	



■ **Program Explanation**

When the SetBOV_EN variable is TRUE, read the state of the specified bit through changing the value of the *Offset* parameter. See the explanation below.

1. When the value of SetBOV_StartR (%MW5) is 8 (2#0000,1000) and SetBOV_Offset is 3, the value of GBOValue is TRUE, which is the value of Bit3 of %MW5.
2. When the value of SetBOV_StartR is 0 and SetBOV_Offset is 3, the value of GBOValue is FALSE, which is the value of Bit3 of %MW5.
3. When the value of %MW6 is 8 (2#0000,1000) and SetBOV_Offset is 19 (which regards the Bit0 of the variable that *StartRegister* points to as the reference), the value of GBOValue is TRUE, which is the value of Bit3 of %MW6.
4. When the value of SetBOV_StartR is 0 and SetBOV_Offset is 19 (which regards the Bit0 of the variable that *StartRegister* points to as the reference), the value of GBOValue is FALSE, which is the value of Bit3 of %MW6.

8.21 FCS Instructions

8.21.1 CRC16

FB/FC	Explanation	Applicable model
FC	CRC16 instruction is used to calculate the CRC value of the specified data.	DVP15MC11T DVP15MC11T-06

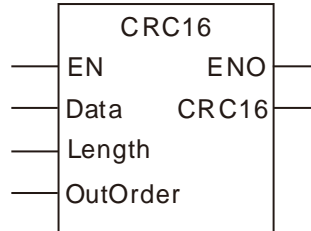

● Input Parameters

Parameter name	Meaning	Input/Output	Description	Valid range
Data	The starting address of the data for CRC value calculation	Input	The starting address of the data for CRC value calculation. The starting address can be got by ADR instruction	—
Length	The length of the data for CRC value calculation	Input	How many bytes of data are for the CRC value calculation by counting from the starting address of the data with the unit: byte.	1~255
OutOrder	Set the arrangement for the bytes of the output CRC value	Input	FALSE means that for the output CRC value, its low byte is on the left of its high byte. TRUE means that for the output CRC value its low byte is on the right of its high byte.	TRUE or FALSE
CRC16	The CRC value	Output	The CRC value got through calculation based on the parameter <i>Data</i>	Depends on the data type of the variable that the output parameter is connected to.

	Boolean	Bit string				Integer							Real number		Time, date			POINTER			
	BOOL	BYTE	WORD	DWORD	LWORD	USINT	UINT	UDINT	ULINT	SINT	INT	DINT	LINT	REAL	LREAL	TIME	DATE	TOD	DT	POINTER TO BYTE	
Data																					•
Length							•														
OutOrder	•																				
CRC16			•																		

Note:

The symbol • indicates that the parameter is allowed to connect to the variable or constant of the data type.

● **Function Explanation**

CRC16 instruction is used to calculate the CRC value of the specified data.

The instruction performs the calculation of the CRC value according to the starting address specified by *Data* and number of bytes specified by *Length*.

The calculation result is put in the output parameter *CRC16*. The arrangement for the bytes of the CRC value is specified by *OutOrder*.

● **Precautions for Correct Use**

The input variables are not allowed to omit. An error will occur during the compiling of the software if any input variable is omitted.



Programming Example

■ **The variable table and program**

Variable name	Address	Data type	Current value
CRC_EN		BOOL	TRUE
IN_Data	%MB100	ARRAY[1..6] OF BYTE	[16#01,16#03,16#10,16#01,16#00,16#02]
IN_Length		UINT	6
IN_OutOrder		BOOL	FALSE
OUT_CRC		WORD	16#910B

- When CRC_EN changes from FALSE to TRUE, the CRC16 instruction checks the 6 bytes [16#01,16#03,16#10,16#01,16#00,16#02] in IN_Data. The calculation result is 16#910B which is put in OUT_CRC.

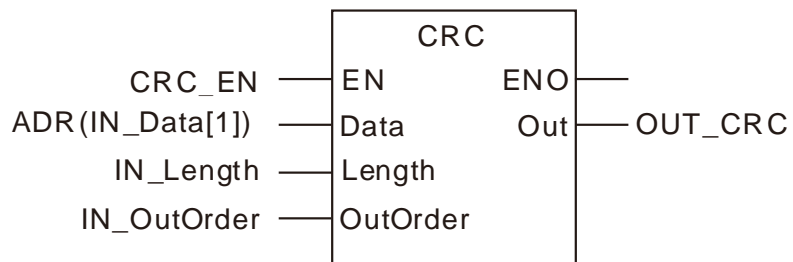

8.21.2 LRC

FB/FC	Explanation	Applicable model
FC	LRC instruction is used to find the LRC value of the specified data.	DVP15MC11T DVP15MC11T-06

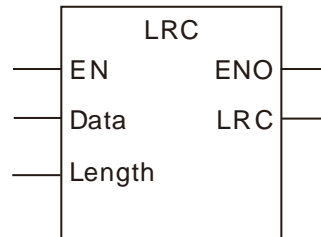

● Input Parameters

Parameter name	Meaning	Input/Output	Description	Valid range
Data	The starting address of the data for LRC value calculation	Input	The starting address of the data for LRC value calculation. The starting address can be got by ADR instruction	---
Length	Length of the data for LRC value calculation	Input	How many bytes of data are for the LRC value calculation by counting from the starting address of the data with the unit: byte.	1~255
LRC	The LRC value	Output	The LRC value of the specified data	Depends on the data type of the variable that the output parameter is connected to.

	Boolean	Bit string					Integer						Real number		Time, date			POINTER			
	BOOL	BYTE	WORD	DWORD	LWORD	USINT	UINT	UDINT	ULINT	SINT	INT	DINT	LINT	REAL	LREAL	TIME	DATE	TOD	DT	POINTER TO BYTE	
Data																					●
Length							●														
LRC		●																			

Note:

The symbol ● indicates that the parameter is allowed to connect to the variable or constant of the data type.

● Function Explanation

LRC instruction is used to find the LRC value of the specified data.

The instruction performs the calculation of the LRC value according to the starting address specified by *Data* and number of bytes specified by *Length*.

The calculation result is put in the output parameter *LRC*.

● **Precautions for Correct Use**

The input variables are not allowed to omit. An error will occur during the compiling of the software if any input variable is omitted.



Programming Example

■ **The variable table and program**

Variable name	Address	Data type	Current value
LRC_EN		BOOL	TRUE
IN_Data	%MB100	ARRAY[1..6] OF BYTE	[16#01,16#03,16#10,16#01,16#00,16#02]
IN_Length		UINT	6
OUT_LRC		WORD	16#E9

- When LRC_EN changes from FALSE to TRUE, the LRC instruction checks the 6 bytes [16#01,16#03,16#10,16#01,16#00,16#02] in IN_Data. The calculation result is 16#E9 which is put in OUT_LRC.

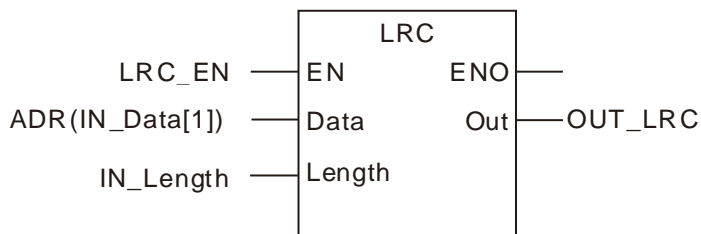

MEMO

Chapter 9 Introductions of Axis Parameters

Table of Contents

9.1 Description of Axis Parameters9-2

9.1 Description of Axis Parameters

Serial No	Parameter Name	Function	Data Type	Default Value
1	Name	Axis name	STRING	-
"Name" is a remark word only used for naming the servo drive without actual meaning.				
2	Node ID	CANopen node ID of an axis; range:1-32	USINT	-
"Node ID" is the CANopen station address of a servo drive.				
3	Axis type&unit	Axis type: linear axis/ rotary axis Unit: the unit of pitch (UnitsPerRotation). E.g. Users can fill mm (millimeter) or ° (degree) as a unit.	-	Linear axis

Linear Axis:

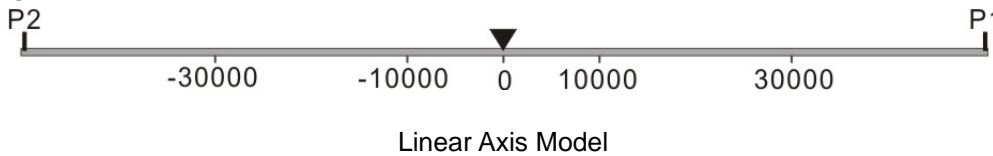

Note:

P1	Positive Limit
P2	Negative Limit
▼	Servo Position

Rotary Axis :

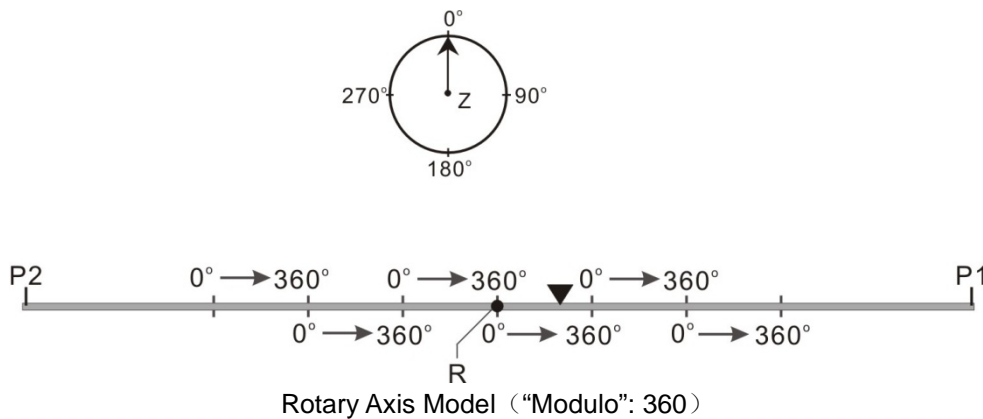

Note:

P1	Positive Limit
P2	Negative Limit
▼	Servo Position
R	Home Position
Z	Axis of the servo motor

Difference between linear axis and rotary axis:

The rotary axis regards modulo as its cycle, which is the difference between linear axis and rotary axis. The position of the terminal actuator of the linear axis is 500 and the corresponding position of the rotary axis is 140 which is the remainder of 500 divided by modulo (360).

Serial No	Parameter Name	Function	Data Type	Default Value
4	Modulo	The cycle used for equally dividing the actual position of the terminal actuator.	LREAL	360
5	Software Limitation	Enables software limitation; If the item is not selected, the maximum/minimum position of the axis which software limits is invalid. If the item is selected, the maximum/minimum position of the axis limited by software is valid.	BOOL	0
6	Maximum Position	The maximum position of the axis limited by software	LREAL	-
7	Minimum Position	The minimum position of the axis limited by software	LREAL	-
8	Maximum Resolution	Maximum resolution for the number of servo pulses	UDINT	1280000
9	Unit Numerator	To set the number of pulses needed when the motor runs one rotation by adjusting the parameter and <i>Unit Denominator</i> .	UINT	128
10	Unit Denominator	To set the number of pulses needed when the motor runs one rotation by adjusting <i>Unit Numerator</i> and the parameter.	UINT	1
11	Pulses/rotation	How many pulses are needed when the servo motor runs one rotation.	UINT	10000
<p><i>Unit Numerator</i> and <i>Unit Denominator</i> jointly set the electronic gear ratio of the servo drive. The electronic gear ratio is used to set how many pulses the servo drive receives for one rotation that the servo motor runs.</p> <p>The resolution of the servo motor is 1,280,000 pulses/rotation. Suppose the value of parameter 11 (Pulses/rotation) is N. So $N * (\text{Unit Numerator} / \text{Unit Denominator}) = 1,280,000$.</p>				
12	InputRotation	This parameter and <i>OutputRotation</i> decide the mechanical gear ratio.	UINT	1
13	OutputRotation	<i>InputRotation</i> and this parameter decide the mechanical gear ratio.	UINT	1
14	UnitsPerRotation	The number of units which the terminal actuator moves while output end of the gear rotates for one circle.	UINT	10000
<p>As illustrated below, InputRotation =1, OutputRotation =2, it means the input mechanism of gear box rotates for one circle and the output mechanism of gear box rotates for 2 circles. UnitsPerRotation represents the corresponding position (units) that ball screw moves while the output mechanism of gear box rotates for one circle.</p> <p>E.g. If output mechanism of gear rotates for one circle and ball screw moves 1mm and UnitsPerRotation is set to 1, through the relative position motion instruction the ball screw will move 1 unit, i.e. the ball screw will move 1mm;</p> <p>If UnitsPerRotation is set to 1000, the ball screw will move 1 unit through the MC_MoveRelative motion instruction, i.e. 1/1000mm actually. The unit of the position in the motion control instruction, G codes and electronic cam is Unit.</p>				

Serial No	Parameter Name	Function	Data Type	Default Value
-----------	----------------	----------	-----------	---------------

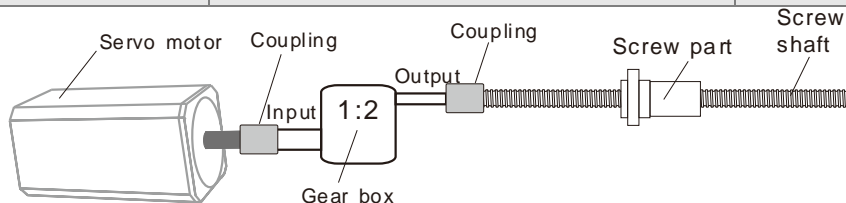

As mentioned above, **UnitsPerRotation** is set to 1 and the ball screw will move 50 mm at the velocity 1mm/s, acceleration 2mm/ s² and change rate of acceleration 1mm/s³ after the following MC_MoveRelative is executed.

The variable table and program

Variable name	Data type	Initial value
Rel	MC_MoveRelative	
Rel_Ex	BOOL	FALSE
Rel_BM	MC_Buffer_Mode	0
Rel_Done	BOOL	
Rel_Bsy	BOOL	
Rel_Act	BOOL	
Rel_Abt	BOOL	
Rel_Err	BOOL	
Rel_ErrID	WORD	

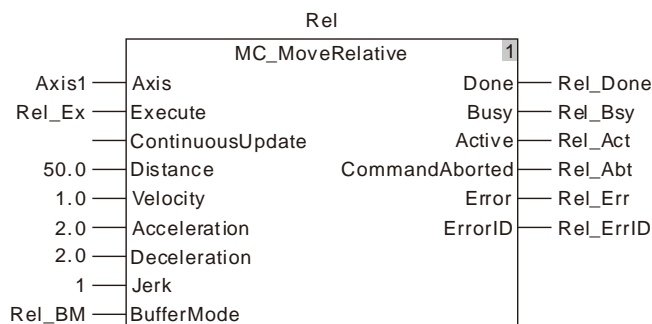

15	Homing Mode	Set the homing mode of the servo drive; range: 1~ 35. See appendix D for more details.	UINT	1
16	Speed 1	The speed from starting homing to finding the home switch; Unit: rpm, setting range: 1-2000 rpm	UDINT	20
	Speed 2	The speed from finding the home switch to reaching the mechanical home; Unit: rpm, setting range: 1-500 rpm	UDINT	10

Chapter 10 Motion Control Function

Table of Contents

- 10.1 EN and ENO 10-2
- 10.2 Relation among Velocity, Acceleration and Jerk 10-3
- 10.3 Introduction of BufferMode 10-6
- 10.4 The State Machine 10-32

DVP-15MC series motion controller is a motion controller which is developed in compliance with CANopen DSP402 motion control protocol and the motion control instructions defined as function blocks are needed for it.

The motion control instructions for the MC module are based on the technical specifications of motion control function blocks in the PLCopen.

Below is the introduction of what need be known about while the motion instructions are used.

10.1 EN and ENO

When one instruction which is used has EN and ENO and EN is FALSE (0), the function defined by instruction will not be performed and the output values of the instruction will not be refreshed. On the contrary, the function defined by the instruction will be performed and the output values will be refreshed if EN is TRUE (1).

The output of ENO and the input of EN keep consistent with each other. ENO changes to TRUE while EN is TRUE. ENO changes to FALSE while EN is FALSE.

For the FB instruction, the instruction execution will continue as its EN changes from TRUE to FALSE after being executed. But the output values of the FB instruction will not be refreshed.

10.2 Relation among Velocity, Acceleration and Jerk

DVP-15MC series motion controller adopts the method of the quadratic-curve acceleration and deceleration. By means of the method, the S-type velocity waveform which is generated can reduce the mechanical shock effectively. In addition, at least the velocity (v), acceleration (Acc) or deceleration (Dec) and change rate of the acceleration (Jerk) need be specified while the motion control instructions are used.

Velocity: Indicates the maximum velocity in the motion of an axis with the unit of unit/second.

Acceleration: Indicates the maximum acceleration in the motion of an axis with the unit of unit/second².

Jerk: Indicates the maximum change rate of the acceleration or deceleration in the motion of an axis with the unit of unit/second³. The value of *Jerk* can be specified in the instruction and the value will be used for the axis in the acceleration and deceleration. The smoothness of the velocity can be improved by modifying the value of *Jerk*.

- **The relation among the velocity, acceleration (deceleration) and jerk:**

$$Acc(Dec) = \frac{dv}{dt}$$

$$Jerk = \frac{dAcc}{dt}$$

The acceleration (deceleration) is the variation of the velocity per unit time. The change rate of acceleration is the variation of the acceleration per unit time. For example, one MC_MoveRelative instruction is be used to express the relation among the three elements. The distance is 1300000 units; the velocity is 100000units/second; the acceleration is 20000units/second² and the jerk is 10000units/second³.

See the following chart for the relation among these elements.

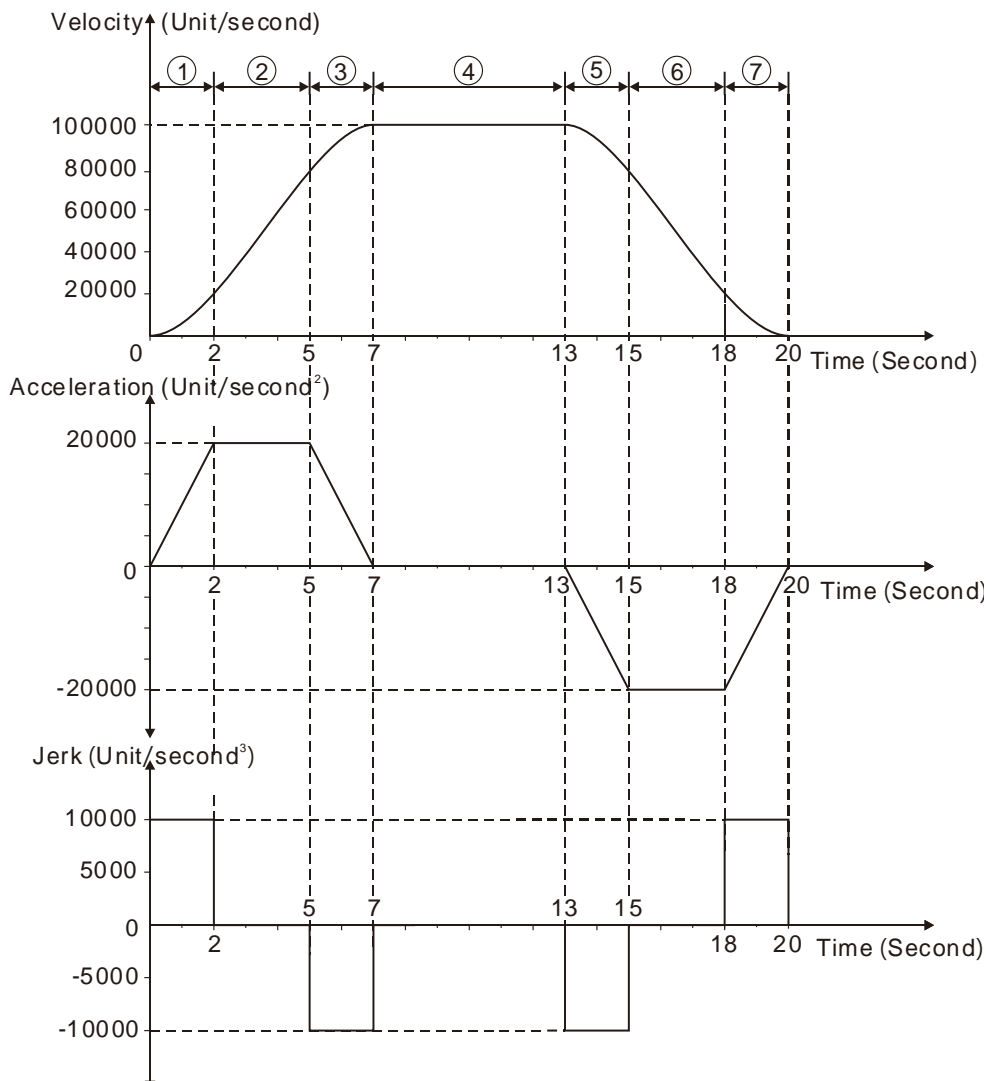

● The relations among Velocity, Acceleration and Jerk are explained in the following table.

Stage No.	Time (second)	Jerk (Unit/second ³)	Acceleration/Deceleration (Unit/second ²)	Velocity (Unit/second)	Motion type
1	0~2	10000 units/second ³	Acceleration is increased to 20000 units/second ²	Increasing	The acceleration motion with an increasing acceleration
2	2~5	0	Acceleration stays at 20000 units/second ²	Increasing	The acceleration motion with a constant acceleration
3	5~7	-10000 units/second ³	Acceleration is decreased to 0.	Increases to 100000 unit/second	The acceleration motion with an decreasing acceleration
4	7~13	0	Acceleration has been decreased to 0unit/second ² and it has been 0unit/second ² during this stage.	100000 unit/second	The motion at a constant speed

Stage No.	Time (second)	Jerk (Unit/second ³)	Acceleration/Deceleration (Unit/second ²)	Velocity (Unit/second)	Motion type
5	13~15	-10000 units/second ³	Deceleration is increased to 20000unit/second ² .	Decreasing	The deceleration motion with an increasing deceleration
6	15~18	0	Deceleration has been increased to 20000units/second ² and it has been 20000units/second ² during this stage.	Decreasing	The deceleration motion with a constant deceleration
7	18~20	10000 units/second ³	Deceleration is decreased to 0.	Decreases to 0	The deceleration motion with a decreasing deceleration

10.3 Introduction of BufferMode

For the same axis, another motion instruction can be started while one motion instruction is controlling the axis motion. There are 6 buffer modes for selection to switch from one motion instruction being executed to another motion instruction. The buffer mode can be selected through the *BufferMode* parameter of the buffered motion instruction.

The terms about *BufferMode* are explained as below.

1. Current instruction: The motion instruction which is controlling the axis currently.
2. Buffered instruction: The instruction which is waiting to be executed.
3. Transit velocity: The speed at which the axis moves at the moment when the currently being executed instruction is switched to the buffered instruction.
4. Target velocity: The *Velocity* parameter of an instruction
5. Target position: The *Position* or *Distance* parameter of the position-related instructions

● Six Buffer Modes for Selection

Buffer Mode	Description
0: mcAborting (Aborting)	The instruction being executed currently is aborted immediately.
1: mcBuffered (Buffered)	The buffered instruction just starts to control the axis after the current instruction execution is completed.
2: mcBlendingLow (Blend with low)	The buffered instruction just starts to control the axis after the target position of the current instruction is reached. The transit velocity is the lower of the target velocities of the current instruction and buffered instruction.
3: mcBlendingPrevious (Blend with previous)	The buffered instruction just starts to control the axis after the target position of the current instruction is reached. The transit velocity is the target velocity of the current instruction.
4: mcBlendingNext (Blend with next)	The buffered instruction just starts to control the axis after the target position of the current instruction is reached. The transit velocity is the target velocity of the buffered instruction.
5: mcBlendingHigh (Blend with high)	The buffered instruction just starts to control the axis after the target position of the current instruction is reached. The transit velocity is the higher of the target velocities of the current instruction and buffered instruction.

Notes:

1. The same axis only supports one buffer mode. An error will occur if multiple buffer modes are performed for the same axis.
For example, the *BufferMode* parameters of instruction 2 and instruction 3 are not mcAborting. Instruction 2 (the buffered instruction) will be switched to from instruction 1 (current instruction). Instruction 3 will report an error if instruction 3 is switched to from instruction 2 when the execution of instruction 1 is not completed. If the *BufferMode* parameter of Instruction 3 is mcAborting, instruction 1 and instruction 2 will be aborted immediately and instruction 3 will be executed right away.
2. When the MC_MoveSuperimposed instruction controls the axis alone, the buffered instruction excluding MC_MoveAdditive is executed and the MC_MoveSuperimposed instruction is aborted no matter what the value of the *BufferMode* parameter is.
While the current instruction and MC_MoveSuperimposed or MC_HaltSuperimposed jointly control the axis and then another motion instruction is executed, all the being executed previously instructions will be aborted if *BufferMode*=mcAborting; if *BufferMode*=mcBuffered, mcBlendingLow, mcBlendingPrevious, mcBlendingNext and mcBlendingHigh, the current instruction and buffered instruction will be blended according to the setting value of *BufferMode* without any impact on the

execution of MC_MoveSuperimposed or MC_HaltSuperimposed.

- **Example: Using two MC_MoveRelative instructions for explanation.**

The maximum velocity of the first MC_MoveRelative instruction is V_1 and distance is S_1 . The maximum velocity of the second MC_MoveRelative instruction is V_2 and distance is S_2 . Modifying the value of *BufferMode* of the second MC_MoveRelative instruction, you can get different blending processes of the two instructions. See details as below.

- **Aborting: Buffermode=mcAborting. See the examples of four cases as below.**

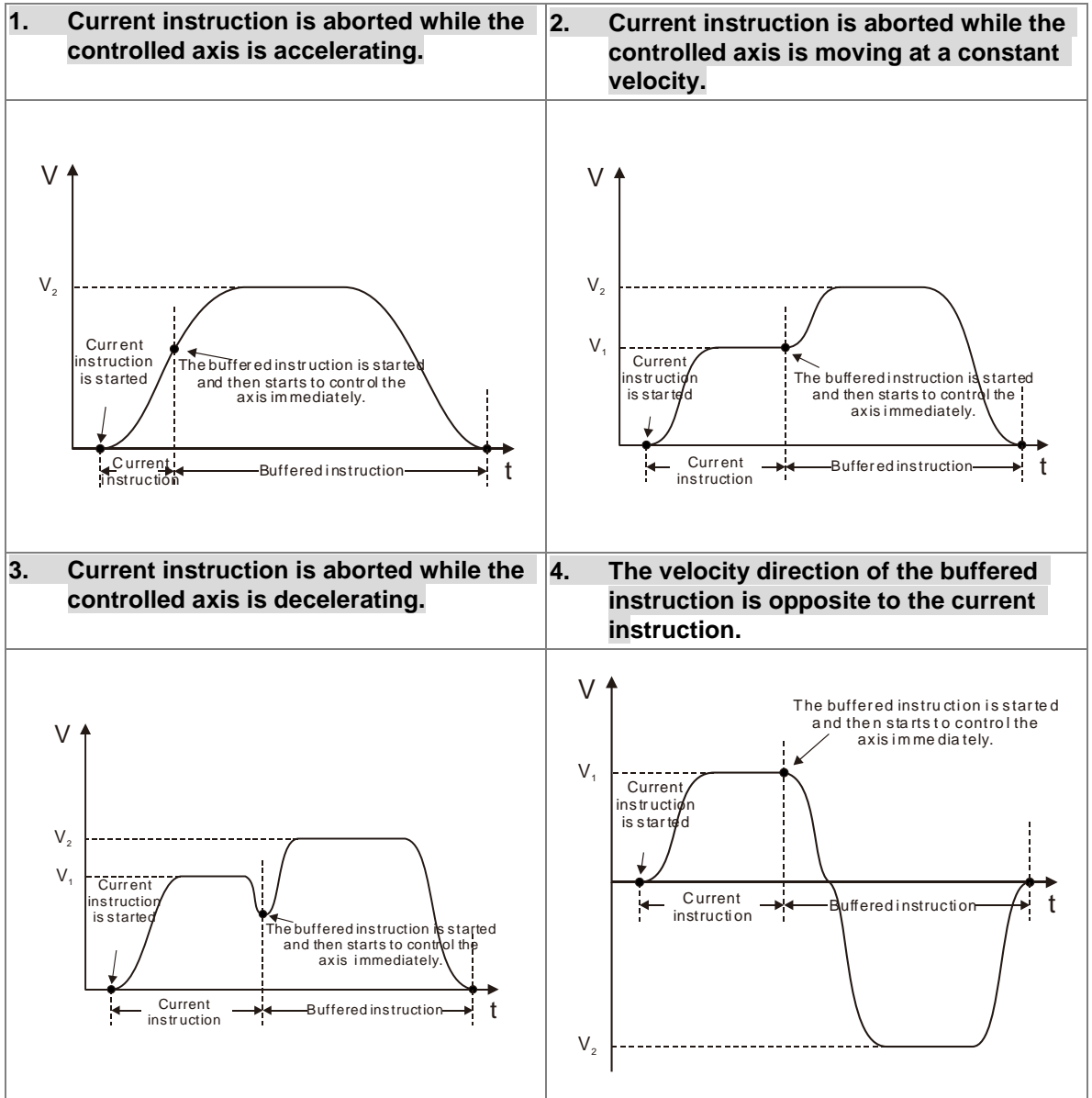

- **Buffered: Buffermode=mcBuffered. See two cases as below.**

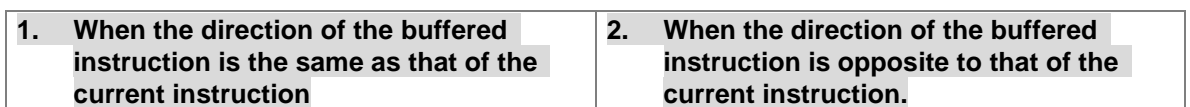

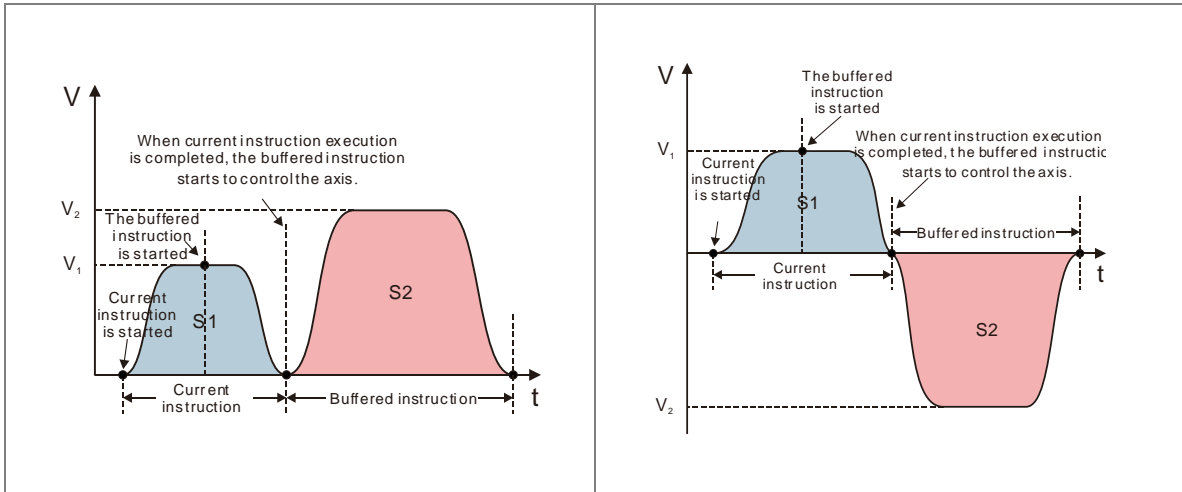

■ **Blending with low velocity: Buffermode=mcBlendingLow. See three cases as below.**

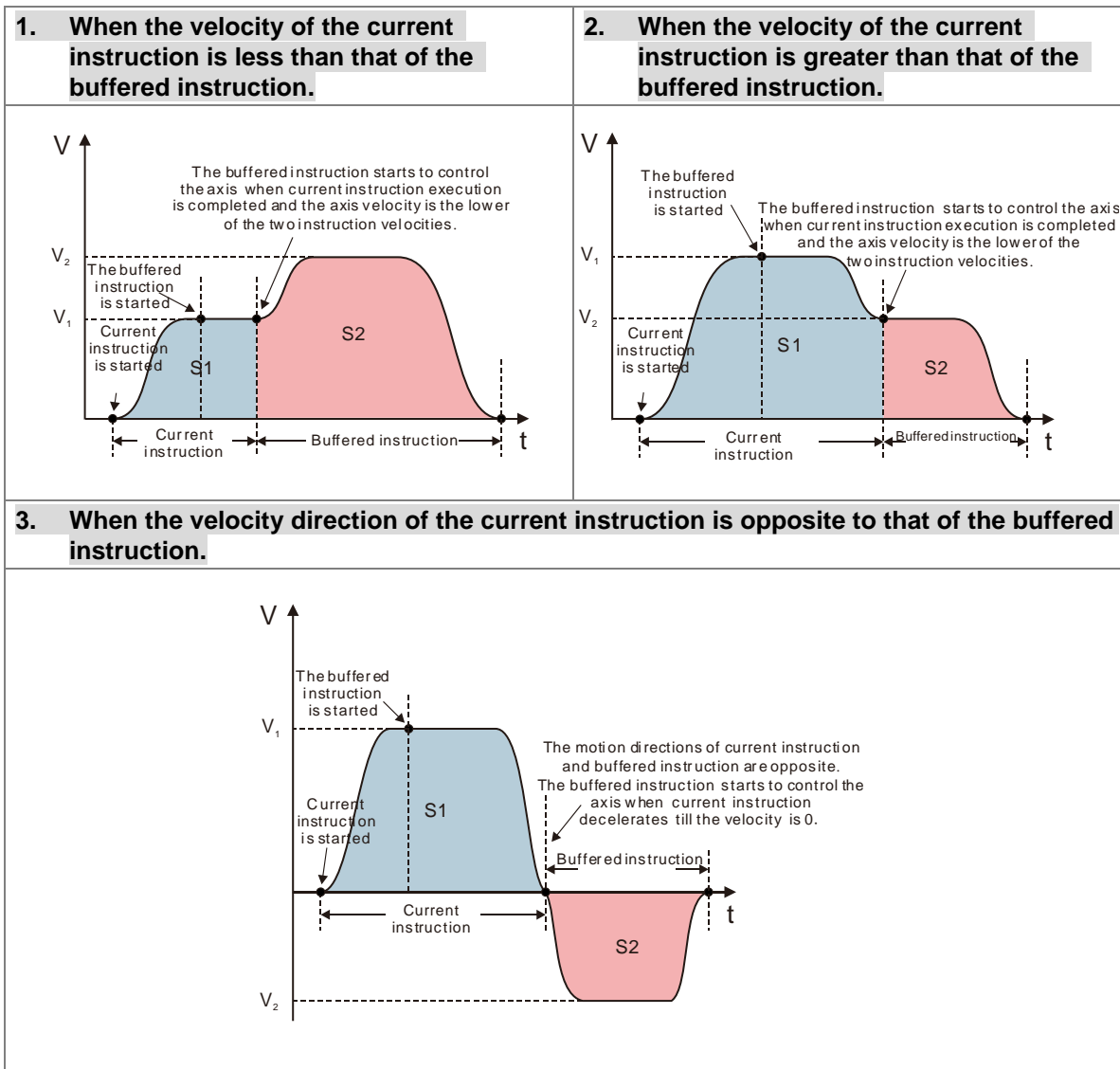

■ **Blending with previous velocity: Buffermode=mcBlendingPrevious. See three cases as below.**

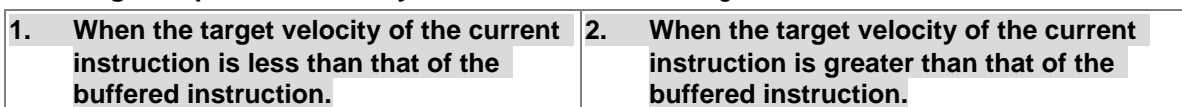

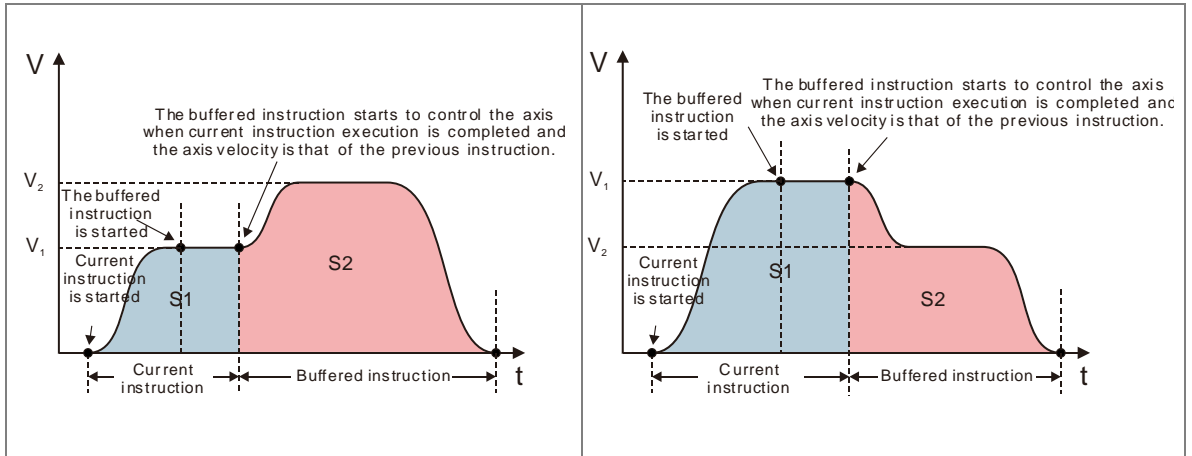

3. When the velocity direction of the current instruction is opposite to that of the buffered instruction.

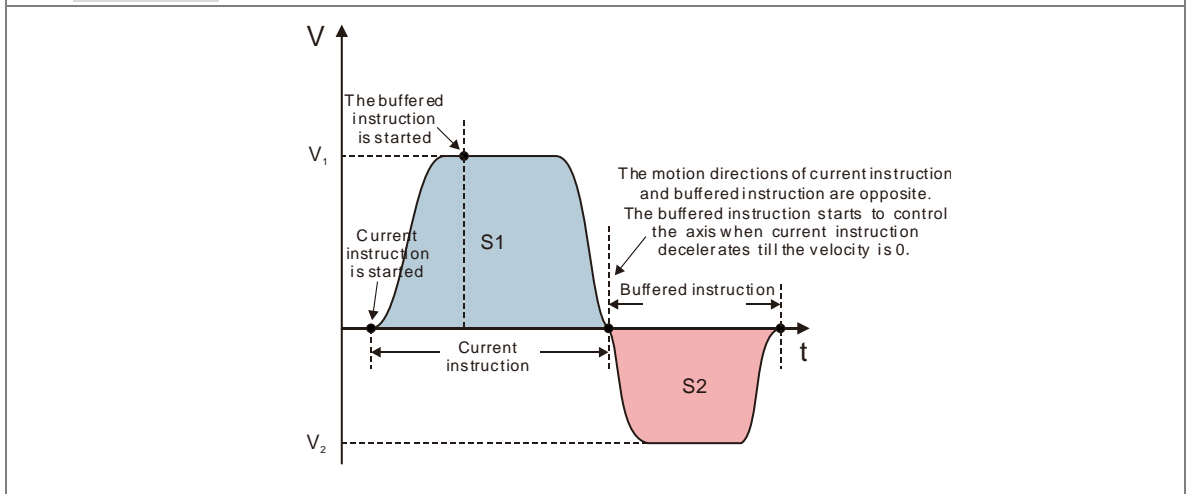

■ **Blending with next velocity: Buffermode=mcBlendingNext. See three cases as below.**

- 1. **When the target velocity of the current instruction is less than that of the buffered instruction**
- 2. **When the target velocity of the current instruction is greater than that of the buffered instruction**

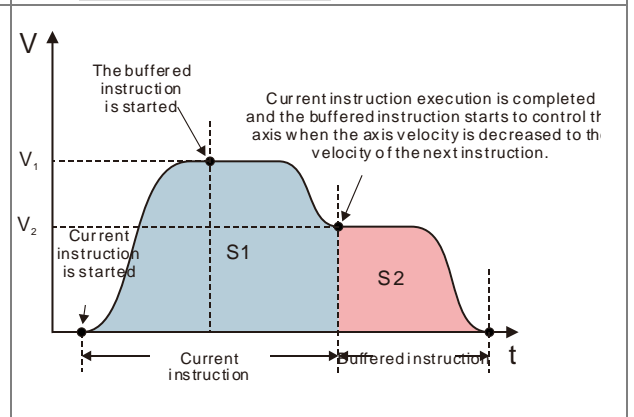
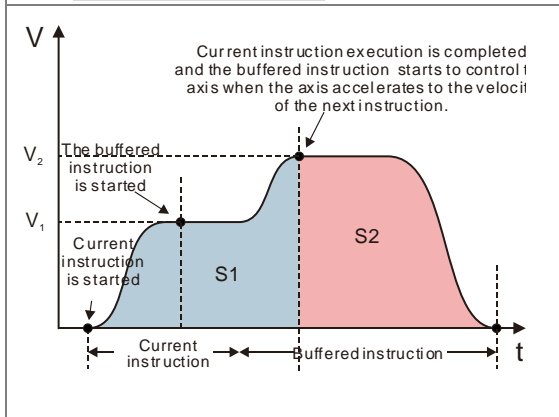

3. When the velocity direction of the current instruction is opposite to that of the buffered instruction

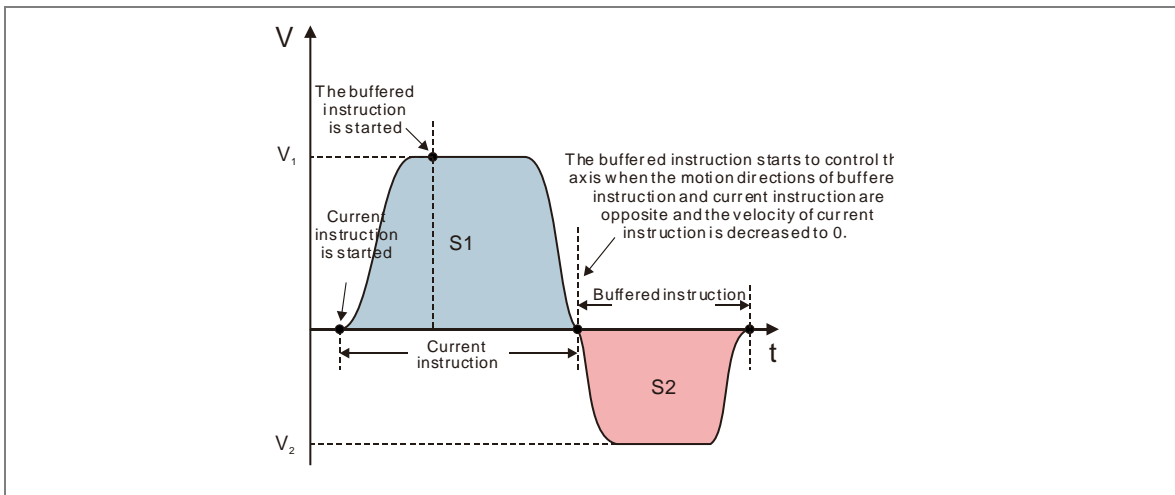

■ **Blending with high velocity: Buffermode=mcBlendingHigh. See three cases as below.**

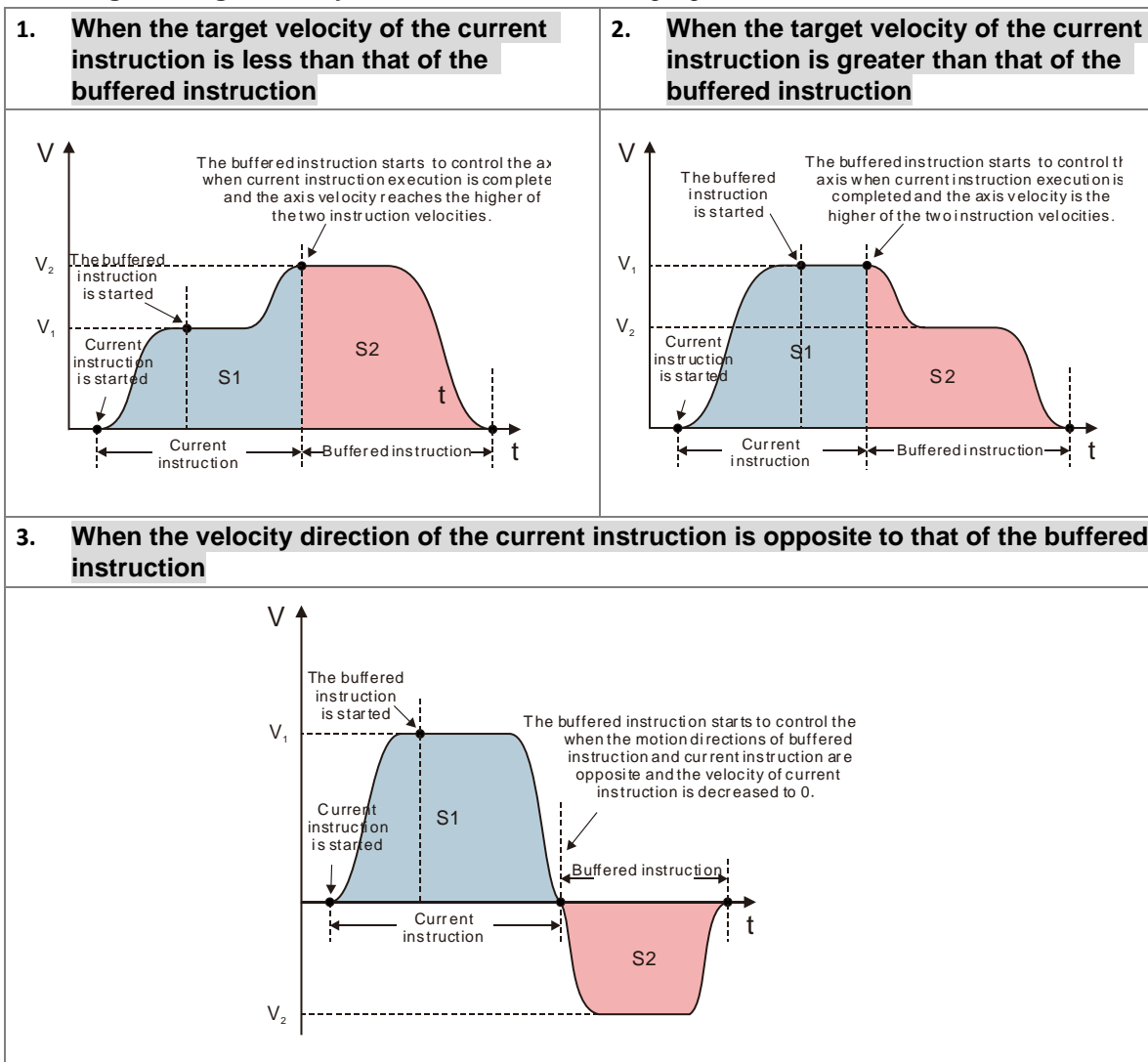

● **Buffer Modes that various instructions support**

The buffer mode of the current instruction and buffered instruction is set by modifying the value of the *BufferMode* parameter. The value of *BufferMode* of the buffered instruction is selected according to the buffer mode that current instruction supports and the *BufferMode* parameter of the current instruction is invalid.

For example:

The *BufferMode* of MC_MoveRelative supports mcAborting, mcBuffered, mcBlendingLow, mcBlendingPrevious, mcBlendingNext and mcBlendingHigh. The *BufferMode* of MC_MoveVelocity supports mcAborting and mcBuffered.

Case 1 : If MC_MoveRelative is the current instruction and MC_MoveVelocity is the buffered instruction. The *BufferMode* parameter of MC_MoveVelocity can select one of mcAborting, mcBuffered, mcBlendingLow, mcBlendingPrevious, mcBlendingNext and mcBlendingHigh.

Case 2 : If MC_MoveVelocity is the current instruction and MC_MoveRelative is the buffered instruction. The *BufferMode* parameter of MC_MoveRelative can select one of mcAborting and mcBuffered.

The buffer mode of the buffered instruction can be selected according to the current instruction as listed below.

Current instruction	The selectable <i>BufferMode</i> value of the buffered instruction
MC_MoveAbsolute	【 mcAborting, mcBuffered, mcBlendingLow, mcBlendingPrevious, mcBlendingNext, mcBlendingHigh 】 *1
MC_MoveRelative	【 mcAborting, mcBuffered, mcBlendingLow, mcBlendingPrevious, mcBlendingNext, mcBlendingHigh 】 *1
MC_MoveAdditive	【 mcAborting, mcBuffered, mcBlendingLow, mcBlendingPrevious, mcBlendingNext, mcBlendingHigh 】 *1
MC_MoveSuperimposed	mcAborting
MC_HaltSuperimposed	mcAborting
MC_MoveVelocity	mcAborting, mcBuffered
MC_Home	Only the MC_Stop instruction can abort the MC_Home instruction.
MC_Halt	mcAborting, mcBuffered
MC_GearIn	mcAborting, mcBuffered
MC_GearOut	mcAborting, mcBuffered
MC_CombineAxes	mcAborting, mcBuffered
MC_CamIn	mcAborting, mcBuffered
MC_CamOut	mcAborting, mcBuffered

*1: The *BufferMode* parameter of the buffered instructions MC_GearIn, MC_CamIn and MC_CombineAxes can only choose mcAborting and mcBuffered.

Whether the current instruction execution has been completed or not depends on the completion output parameter of the instruction. As the completion output parameter is TRUE, it indicates that the instruction execution is completed and the buffered instruction execution starts.

See the completion output parameters of instructions in the following table so as to judge the instruction execution state in a buffer mode.

Instruction name	Is it a buffered instruction? (Yes or No)	Can it be followed by a buffered instruction? (Yes or No)	Completion output parameter of an instruction
MC_Home	No	No	Done
MC_Stop	No	No	Done
MC_Halt	Yes	Yes	Done
MC_MoveAbsolute	Yes	Yes	Done
MC_MoveRelative	Yes	Yes	Done
MC_MoveAdditive	Yes	Yes	Done
MC_MoveSuperimposed	No	No	—
MC_HaltSuperimposed	No	No	—
MC_MoveVelocity	Yes	Yes	InVelocity
MC_CamIn	Yes	Yes	EndOfProfile
MC_CamOut	No	Yes	Done
MC_GearIn	Yes	Yes	InGear
MC_GearOut	No	Yes	Done
MC_CombineAxes	Yes	Yes	InSync

● Examples of Buffer Modes

Example 1

The following example explains six buffer modes for the switch from the execution of one MC_MoveRelative instruction to the other MC_MoveRelative instruction.

The variable table and program

Variable name	Data type	Initial value
Pwr	MC_Power	
Axis1	USINT	1
Pwr_BM	MC_Buffer_Mode	0
Pwr_Sta	BOOL	
Pwr_Bsy	BOOL	
Pwr_Act	BOOL	
Pwr_Err	BOOL	
Pwr_ErrID	WORD	
Rel1	MC_MoveRelative	
Rel1_Ex	BOOL	FALSE
Rel1_BM	MC_Buffer_Mode	0
Rel1_Done	BOOL	
Rel1_Bsy	BOOL	
Rel1_Act	BOOL	
Rel1_Abt	BOOL	
Rel1_Err	BOOL	
Rel1_ErrID	WORD	
Rel2	MC_MoveRelative	
Rel2_Ex	BOOL	FALSE
Rel2_BM	MC_Buffer_Mode	

Variable name	Data type	Initial value
Rel2_Done	BOOL	
Rel2_Bsy	BOOL	
Rel2_Act	BOOL	
Rel2_Abt	BOOL	
Rel2_Err	BOOL	
Rel2_ErrID	WORD	

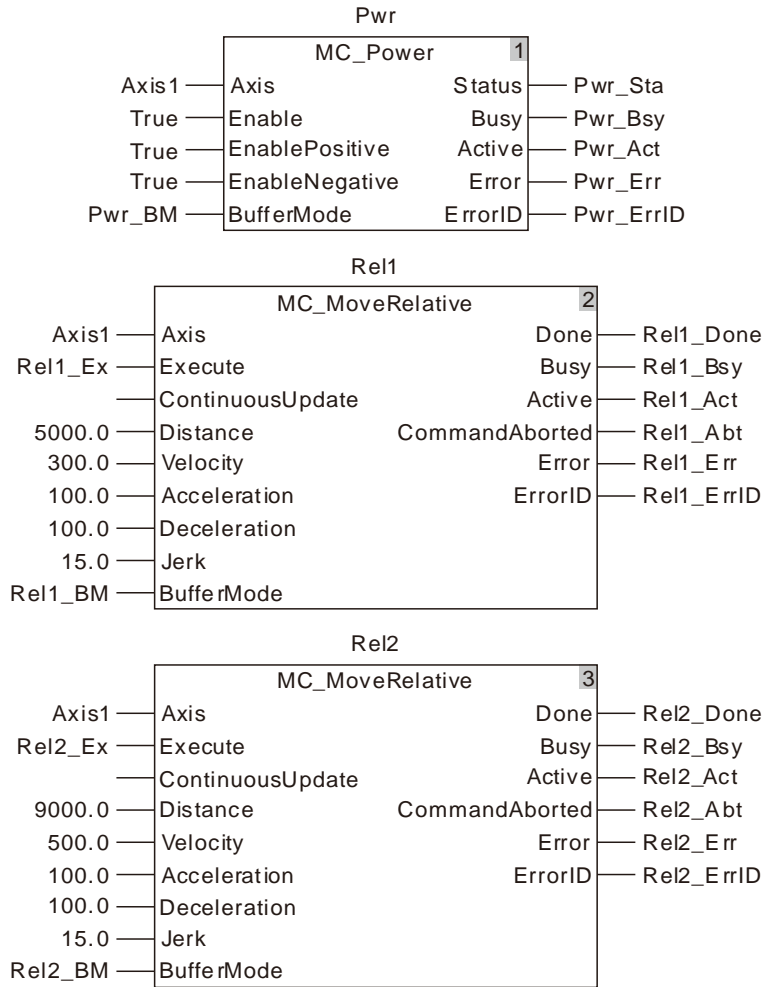

■ Rel2_BM=mcAborting

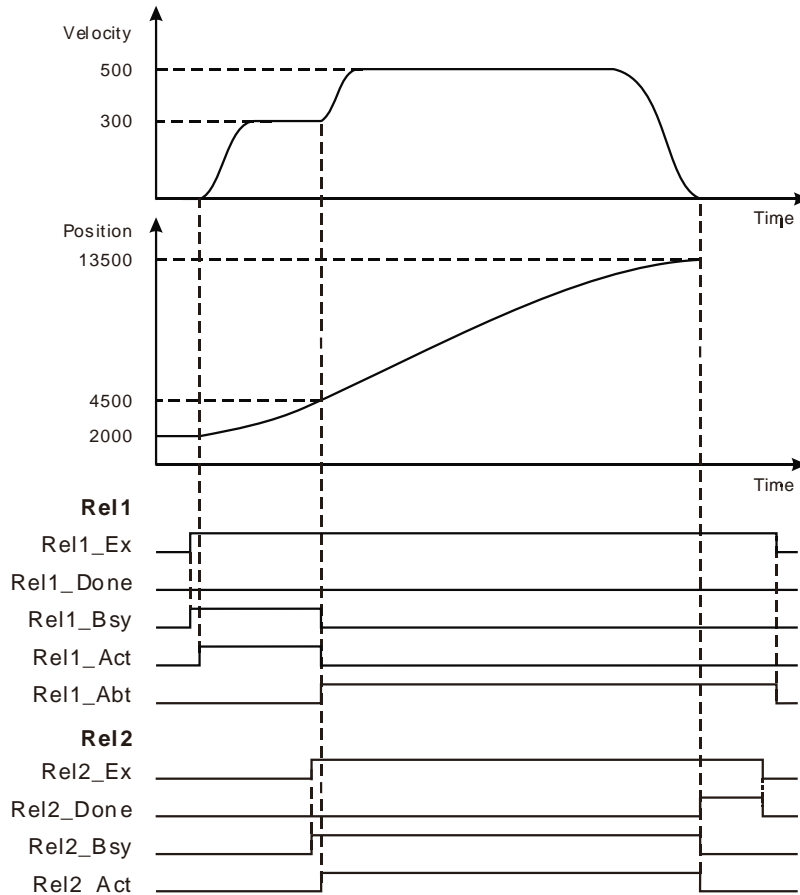

- ❖ As Rel1_Ex changes from FALSE to TRUE, Rel1_Bsy changes to TRUE. One period later, Rel1_Act changes to TRUE and the first MC_MoveRelative instruction execution starts. While the target position is not reached yet, Rel2_Ex changes from FALSE to TRUE and Rel2_Bsy changes to TRUE. One period later, Rel1_Abt and Rel2_Act change to TRUE and Rel1_Bsy and Rel1_Act change to FALSE. Meanwhile the first MC_MoveRelative instruction is aborted and the second MC_MoveRelative instruction execution starts. As the target position is reached, Rel2_Done changes to TRUE and meanwhile Rel2_Bsy and Rel2_Act change to FALSE.
- ❖ As Rel2_Ex changes from TRUE to FALSE, Rel2_Done changes to FALSE.

■ Rel2_BM =mcMcBuffered

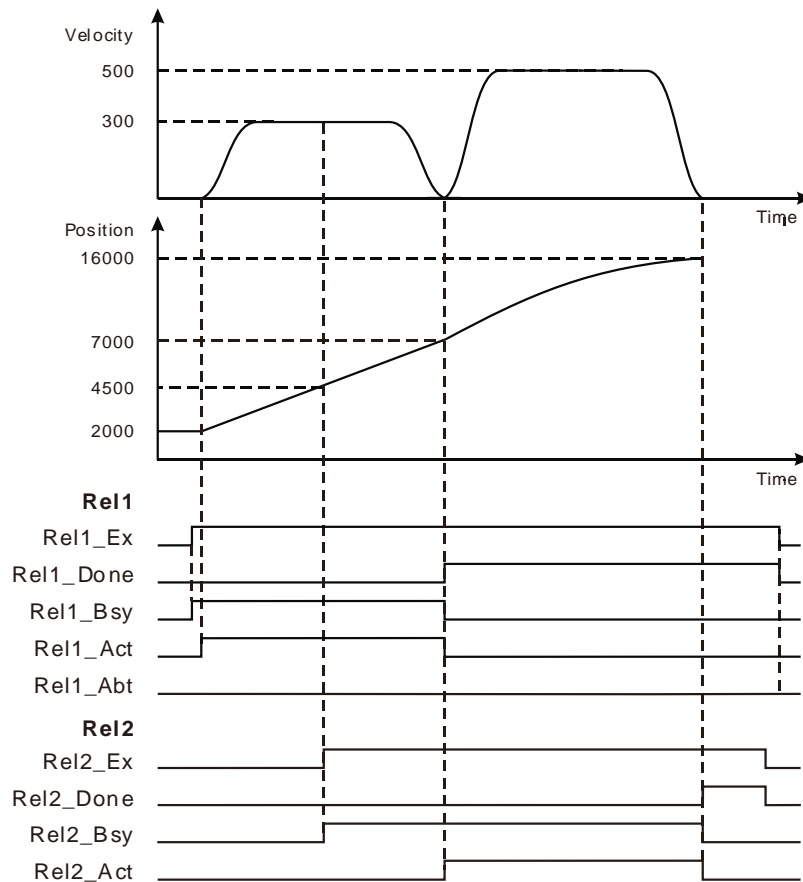

- ❖ As Rel1_Ex changes from FALSE to TRUE, Rel1_Bsy changes to TRUE. One period later, Rel1_Act changes to TRUE and the first MC_MoveRelative instruction execution starts. While the target position is not reached yet and Rel2_Ex changes from FALSE to TRUE, Rel2_Bsy changes to TRUE, Rel1_Bsy and Rel1_Act remain TRUE and the first MC_MoveRelative instruction execution continues. As the target position is reached, Rel1_Done changes to TRUE, Rel1_Bsy and Rel1_Act change to FALSE. Rel2_Act changes to TRUE and the second MC_MoveRelative instruction execution starts immediately. When the target position is reached, Rel2_Done changes to TRUE and meanwhile Rel2_Bsy and Rel2_Act change to FALSE.
- ❖ As Rel1_Ex changes from TRUE to FALSE, Rel1_Done changes to FALSE. As Rel2_Ex changes from TRUE to FALSE, Rel2_Done changes to FALSE.

■ **Rel2_BM =mcBlendingLow**

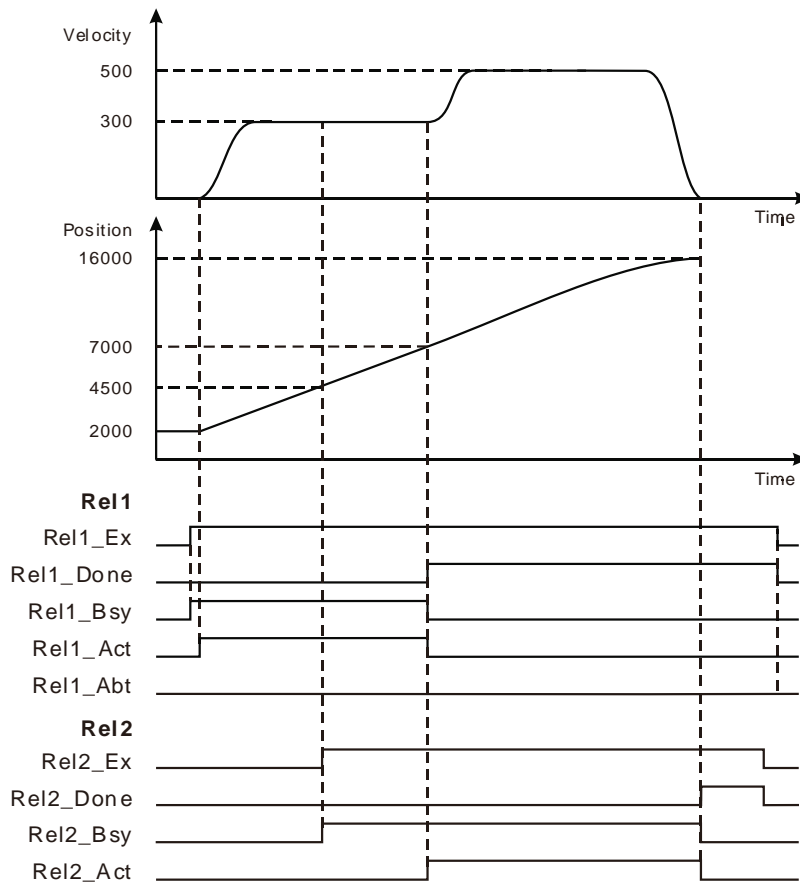

- ❖ As Rel1_Ex changes from FALSE to TRUE, Rel1_Bsy changes to TRUE. One period later, Rel1_Act changes to TRUE and the first MC_MoveRelative instruction execution starts. While the target position is not reached yet and Rel2_Ex changes from FALSE to TRUE, Rel2_Bsy changes to TRUE, Rel1_Bsy and Rel1_Act remain TRUE and the first MC_MoveRelative instruction execution continues. As the target position is reached, Rel1_Done changes to TRUE. At the moment, the velocity is 300 units /second which is the lower one of the target velocities of the current instruction and buffered instruction, Rel1_Bsy and Rel1_Act change to FALSE, Rel2_Act changes to TRUE and the second MC_MoveRelative instruction execution starts immediately. As the target position is reached, Rel2_Done changes to TRUE and meanwhile Rel2_Bsy and Rel2_Act change to FALSE.
- ❖ As Rel1_Ex changes from TRUE to FALSE, Rel1_Done changes to FALSE. As Rel2_Ex changes from TRUE to FALSE, Rel2_Done changes to FALSE.

■ Rel2_BM =mcBlending_Previous

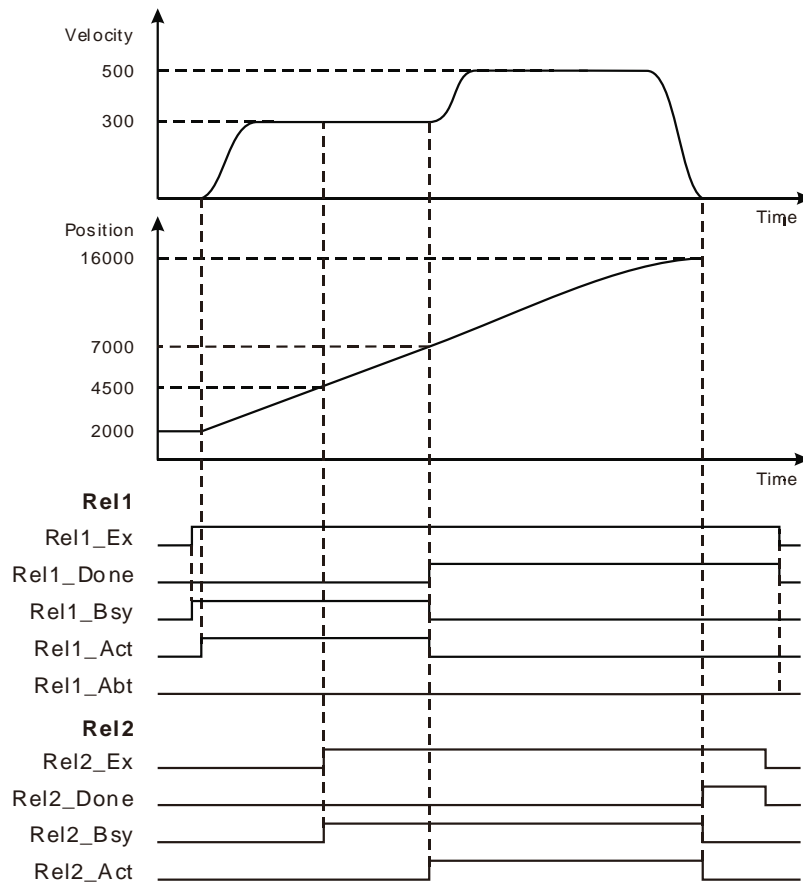

- ❖ As Rel1_Ex changes from FALSE to TRUE, Rel1_Bsy changes to TRUE. One period later, Rel1_Act changes to TRUE and the first MC_MoveRelative instruction execution starts. While the target position is not reached yet and Rel2_Ex changes from FALSE to TRUE, Rel2_Bsy changes to TRUE, Rel1_Bsy and Rel1_Act remain TRUE and the first MC_MoveRelative instruction execution continues. As the target position is reached, Rel1_Done changes to TRUE. At the moment, the velocity is 300 units /second which is the target velocity of the current instruction, Rel1_Bsy and Rel1_Act change to FALSE, Rel2_Act changes to TRUE and the second MC_MoveRelative instruction execution starts immediately. As the target position is reached, Rel2_Done changes to TRUE and meanwhile Rel2_Bsy and Rel2_Act change to FALSE.
- ❖ As Rel1_Ex changes from TRUE to FALSE, Rel1_Done changes to FALSE. As Rel2_Ex changes from TRUE to FALSE, Rel2_Done changes to FALSE.

■ Rel2_BM =mcBlending_Next

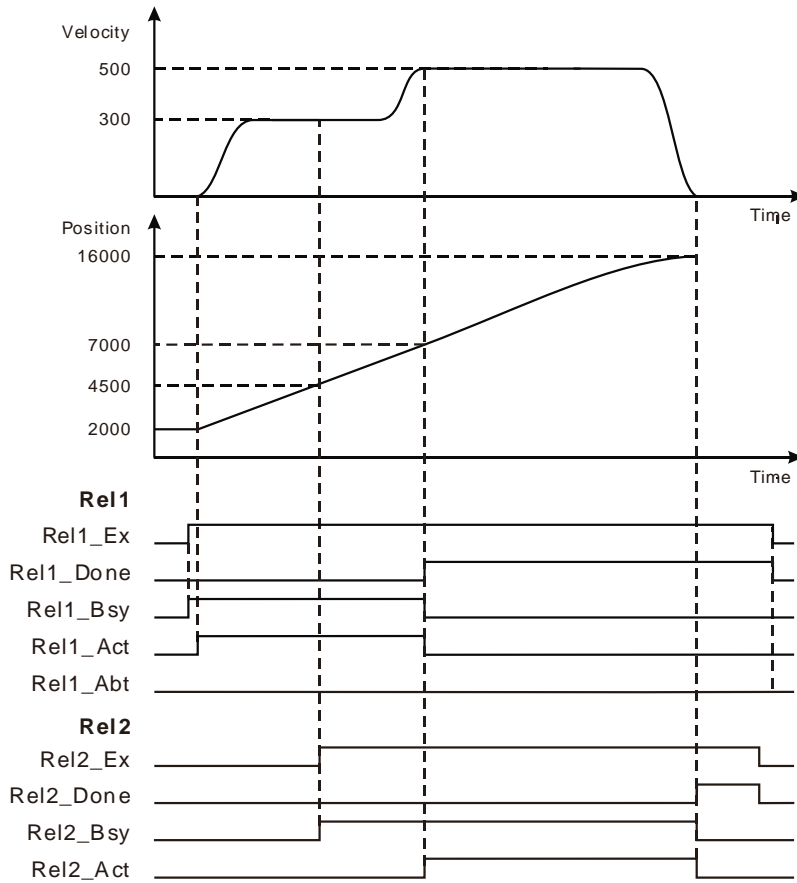

- ❖ As Rel1_Ex changes from FALSE to TRUE, Rel1_Bsy changes to TRUE. One period later, Rel1_Act changes to TRUE and the first MC_MoveRelative instruction execution starts. While the target position is not reached yet and Rel2_Ex changes from FALSE to TRUE, Rel2_Bsy changes to TRUE, Rel1_Bsy and Rel1_Act remain TRUE and the first MC_MoveRelative instruction execution continues. As the target position is reached, Rel1_Done changes to TRUE. At the moment, the velocity is 500 units /second which is the target velocity of the buffered instruction; Rel1_Bsy and Rel1_Act change to FALSE; Rel2_Act changes to TRUE and the second MC_MoveRelative instruction execution starts. As the target position is reached, Rel2_Done changes to TRUE and meanwhile Rel2_Bsy and Rel2_Act change to FALSE.
- ❖ As Rel1_Ex changes from TRUE to FALSE, Rel1_Done changes to FALSE. As Rel2_Ex changes from TRUE to FALSE, Rel2_Done changes to FALSE.

■ Rel2_BM =mcBlending_High

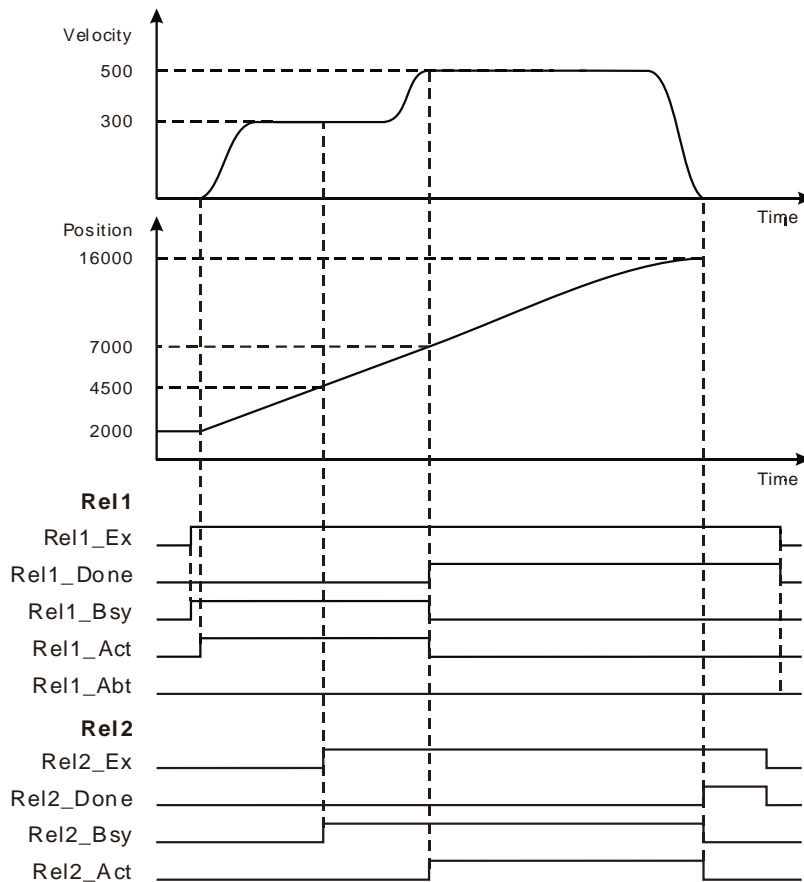

- ❖ As Rel1_Ex changes from FALSE to TRUE, Rel1_Bsy changes to TRUE. One period later, Rel1_Act changes to TRUE and the first MC_MoveRelative instruction execution starts. While the target position is not reached yet and Rel2_Ex changes from FALSE to TRUE, Rel2_Bsy changes to TRUE, Rel1_Bsy and Rel1_Act remain TRUE and the first MC_MoveRelative instruction execution continues. As the target position is reached, Rel1_Done changes to TRUE. At the moment, the velocity is 500 units /second which is the higher one of the target velocities of the current instruction and buffered instruction; Rel1_Bsy and Rel1_Act change to FALSE; Rel2_Act changes to TRUE and the second MC_MoveRelative instruction execution starts. As the target position is reached, Rel2_Done changes to TRUE and meanwhile Rel2_Bsy and Rel2_Act change to FALSE.
- ❖ As Rel1_Ex changes from TRUE to FALSE, Rel1_Done changes to FALSE. As Rel2_Ex changes from TRUE to FALSE, Rel2_Done changes to FALSE.

● **Example 2**

The following example explains the axis states for different *BufferMode* values with a MC_MoveVelocity instruction and a MC_MoveRelative instruction which is the buffered instruction.

The variable table and program

Variable name	Data type	Initial value
Pwr	MC_Power	
Axis1	USINT	1
Pwr_En	BOOL	FALSE
Pwr_BM	MC_Buffer_Mode	0
Pwr_Sta	BOOL	
Pwr_Bsy	BOOL	
Pwr_Act	BOOL	
Pwr_Err	BOOL	
Pwr_ErrID	WORD	
Vel	MC_MoveVelocity	
Vel_Ex	BOOL	FALSE
Vel_Vel	LREAL	10000.0
Vel_Acc	LREAL	10000.0
Vel_Dec	LREAL	10000.0
Vel_Jerk	LREAL	10000.0
Vel_Dir	MC_DIRECTION	1
Vel_BM	MC_Buffer_Mode	
Vel_Invel	BOOL	
Vel_Bsy	BOOL	
Vel_Act	BOOL	
Vel_Abt	BOOL	
Vel_Err	BOOL	
Vel_ErrID	WORD	
Rel	MC_MoveRelative	
Rel_Ex	BOOL	FALSE
Rel_Dist	LREAL	100000.0
Rel_Vel	LREAL	20000.0
Rel_Acc	LREAL	10000.0
Rel_Dec	LREAL	10000.0
Rel_Jerk	LREAL	10000.0
Rel_BM	MC_Buffer_Mode	0
Rel_Done	BOOL	
Rel_Bsy	BOOL	
Rel_Act	BOOL	
Rel_Abt	BOOL	
Rel_Err	BOOL	
Rel_ErrID	WORD	

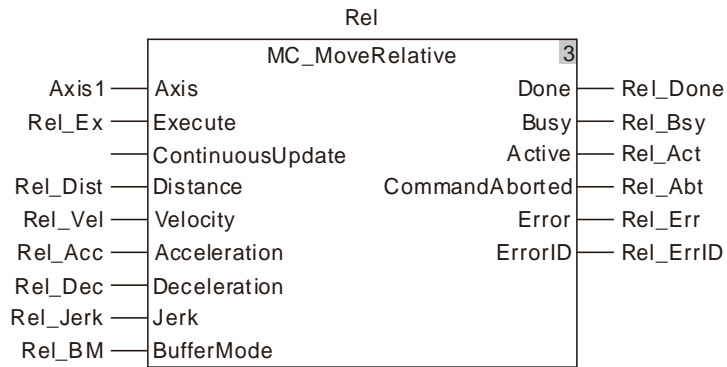
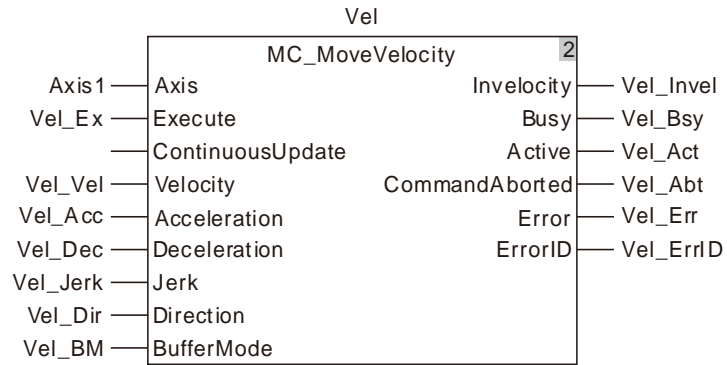
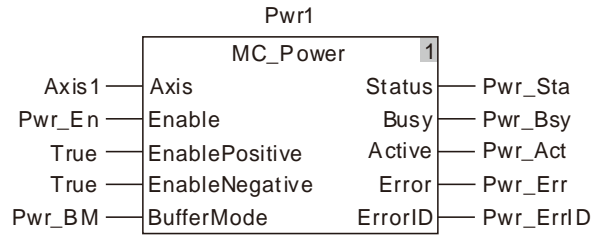

■ **Rel_BM =mcAborting**

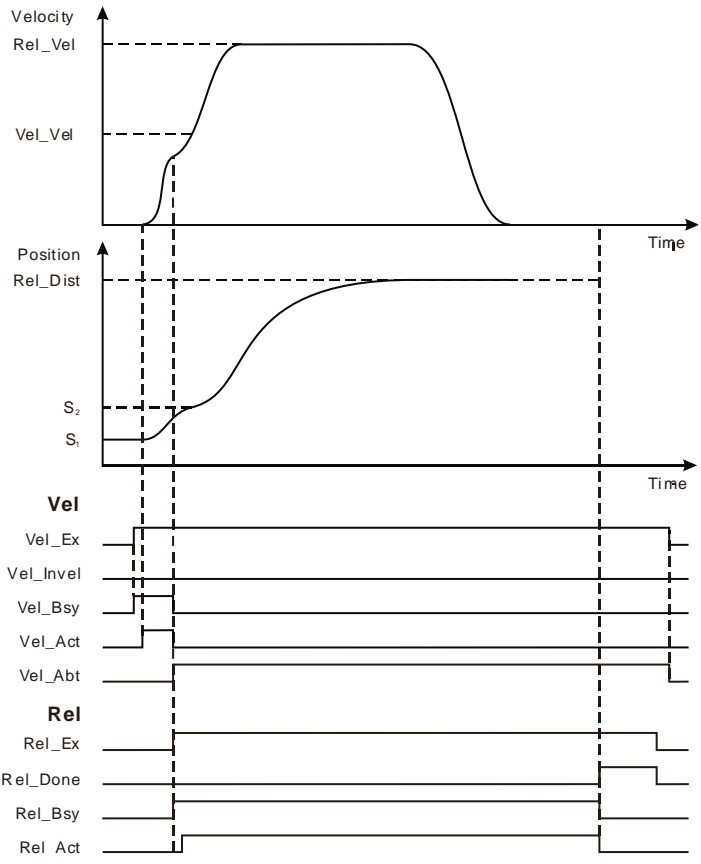

- ❖ As Vel_Ex changes from FALSE to TRUE, Vel_Bsy changes to TRUE. One period later, Vel_Act changes to TRUE. Before the target velocity is reached, the axis moves at the velocity and acceleration specified by the MC_MoveRelative instruction as Rel_Ex changes from FALSE to TRUE. As Vel_Abt changes to TRUE, Vel_Bsy and Vel_Act change to FALSE, the velocity instruction is aborted, the MC_MoveRelative instruction is executed and Rel_Bsy changes to TRUE. One period later, Rel_Act changes to TRUE. As the positioning is completed, Rel_Done changes to TRUE.

■ Rel_BM = mcBuffered

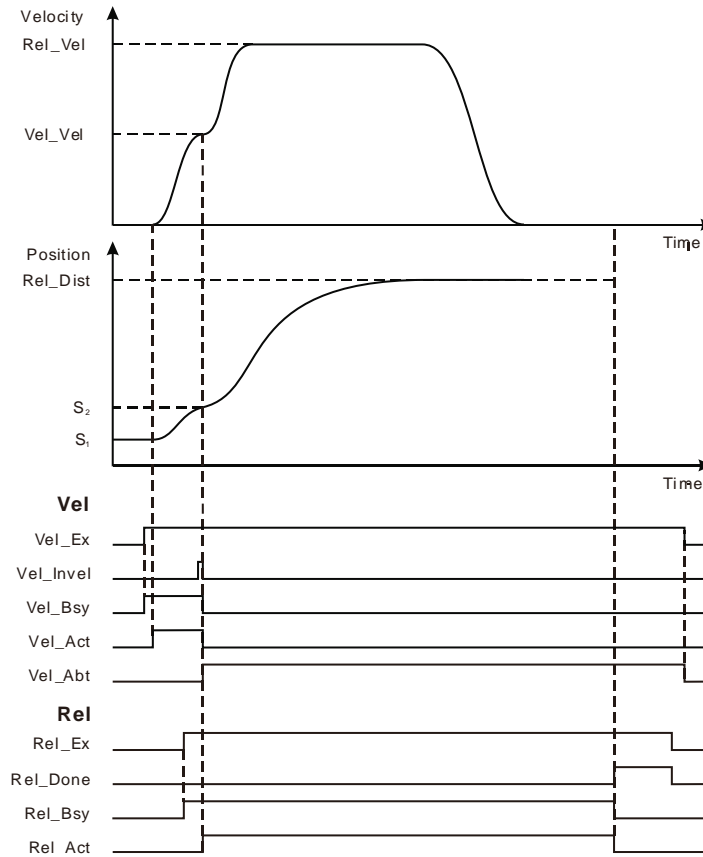

- ❖ As Vel_Ex changes from FALSE to TRUE, Vel_Bsy changes to TRUE. One period later, Vel_Act changes to TRUE. Rel_Ex changes from FALSE to TRUE when the target velocity is not reached. The axis will not execute the MC_MoveRelative instruction till the velocity instruction execution is completed. At the moment, Rel_Bsy changes to TRUE. When the velocity instruction execution is completed, Vel_Invel changes to TRUE and one period later, the MC_MoveRelative instruction starts to control the axis. Vel_Abt changes to TRUE and the velocity instruction is aborted. Rel_Act is TRUE, which means that the MC_MoveRelative instruction starts to control the motion of the axis. Rel_Done changes to TRUE as the positioning is completed.

- (The effect of Rel_BM = mcBlendingLow, mcBlendingPrevious, mcBlendingNext or mcBlendingHigh is the same as that of Rel_BM = mcBuffered.)

● Example 3

The example explains the axis states for different *BufferMode* value with a MC_MoveRelative instruction and a MC_MoveVelocity instruction which is the buffered instruction.

The variable table and program

Variable name	Data type	Initial value
Pwr	MC_Power	
Axis1	USINT	1
Pwr_En	BOOL	FALSE
Pwr_BM	MC_Buffer_Mode	0
Pwr_Sta	BOOL	
Pwr_Bsy	BOOL	
Pwr_Act	BOOL	
Pwr_Err	BOOL	

Variable name	Data type	Initial value
Pwr_ErrID	WORD	
Rel	MC_MoveRelative	
Rel_Ex	BOOL	FALSE
Rel_Dist	LREAL	100000.0
Rel_Vel	LREAL	10000.0
Rel_Acc	LREAL	10000.0
Rel_Dec	LREAL	10000.0
Rel_Jerk	LREAL	10000.0
Rel_BM	MC_Buffer_Mode	0
Rel_Done	BOOL	
Rel_Bsy	BOOL	
Rel_Act	BOOL	
Rel_Abt	BOOL	
Rel_Err	BOOL	
Rel_ErrID	WORD	
Vel	MC_MoveVelocity	
Vel_Ex	BOOL	FALSE
Vel_Vel	LREAL	20000.0
Vel_Acc	LREAL	10000.0
Vel_Dec	LREAL	10000.0
Vel_Jerk	LREAL	10000.0
Vel_Dir	MC_DIRECTION	1
Vel_BM	MC_Buffer_Mode	
Vel_Invel	BOOL	
Vel_Bsy	BOOL	
Vel_Act	BOOL	
Vel_Abt	BOOL	
Vel_Err	BOOL	
Vel_ErrID	WORD	

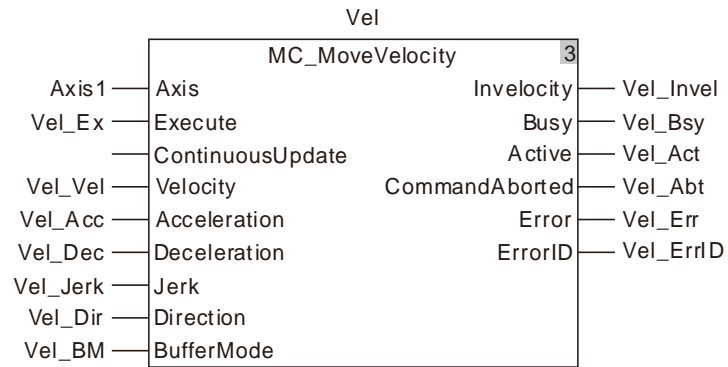
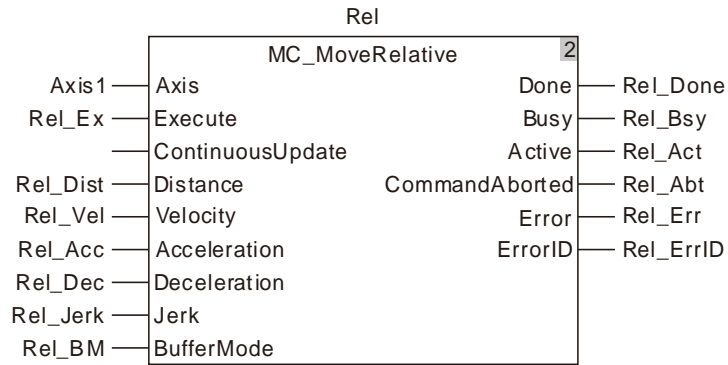
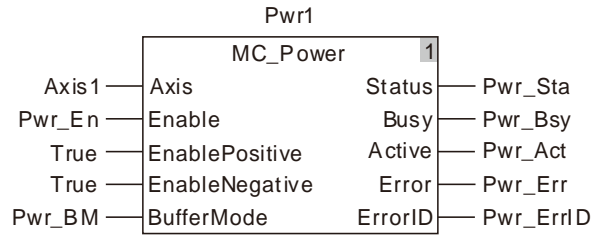

■ **Vel_BM =mcAborting**

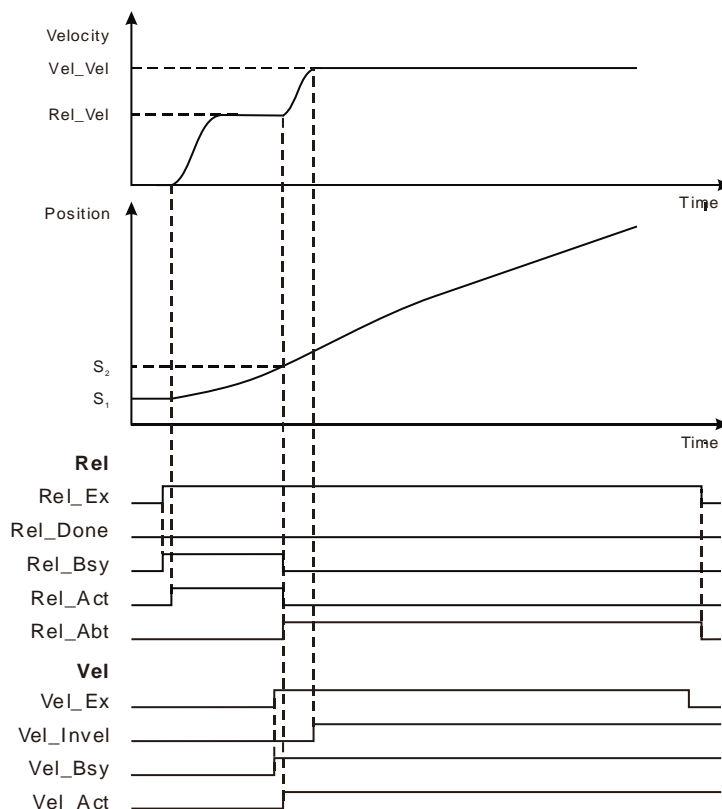

- ❖ As *Rel_Ex* changes from FALSE to TRUE, *Rel_Bsy* changes to TRUE. One period later, *Rel_Act* changes to TRUE. When the target position is not reached, *Vel_Ex* changes from FALSE to TRUE, the axis moves at the velocity and acceleration specified by the velocity instruction. When *Rel_Abt* changes to TRUE, *Rel_Bsy* and *Rel_Act* change to FALSE, the MC_MoveRelative instruction is aborted and the velocity instruction is executed. *Vel_Bsy* is TRUE and one period later, *Vel_Act* changes to TRUE. As the velocity is reached, *Vel_Invel* changes to TRUE.

■ Vel_BM =mcBuffered

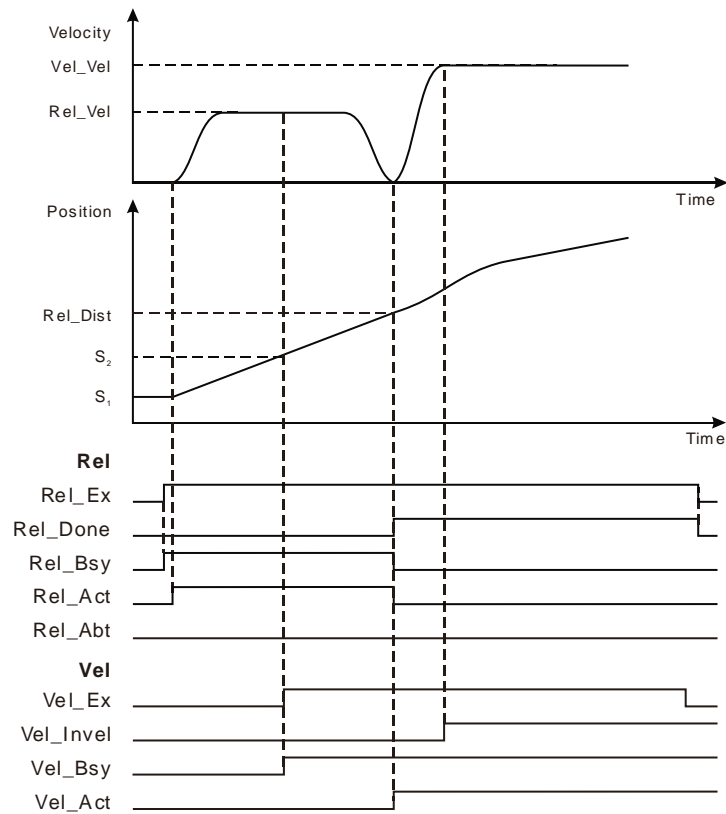

- ❖ As **Rel_Ex** changes from FALSE to TRUE, **Rel_Bsy** changes to TRUE. One period later, **Rel_Act** changes to TRUE. When the target position is not reached, **Vel_Ex** changes from FALSE to TRUE. The axis decelerates to 0 when the execution of the MC_MoveRelative instruction is completed. Then **Rel_Done** changes to TRUE, **Rel_Bsy** and **Rel_Act** change to FALSE and the axis moves at the velocity and acceleration specified by the velocity instruction. **Vel_Bsy** changes to TRUE and one period later, **Vel_Act** changes to TRUE. **Rel_Invel** changes to TRUE as the target velocity is reached.

■ **Vel_BM =mcBlendingLow**

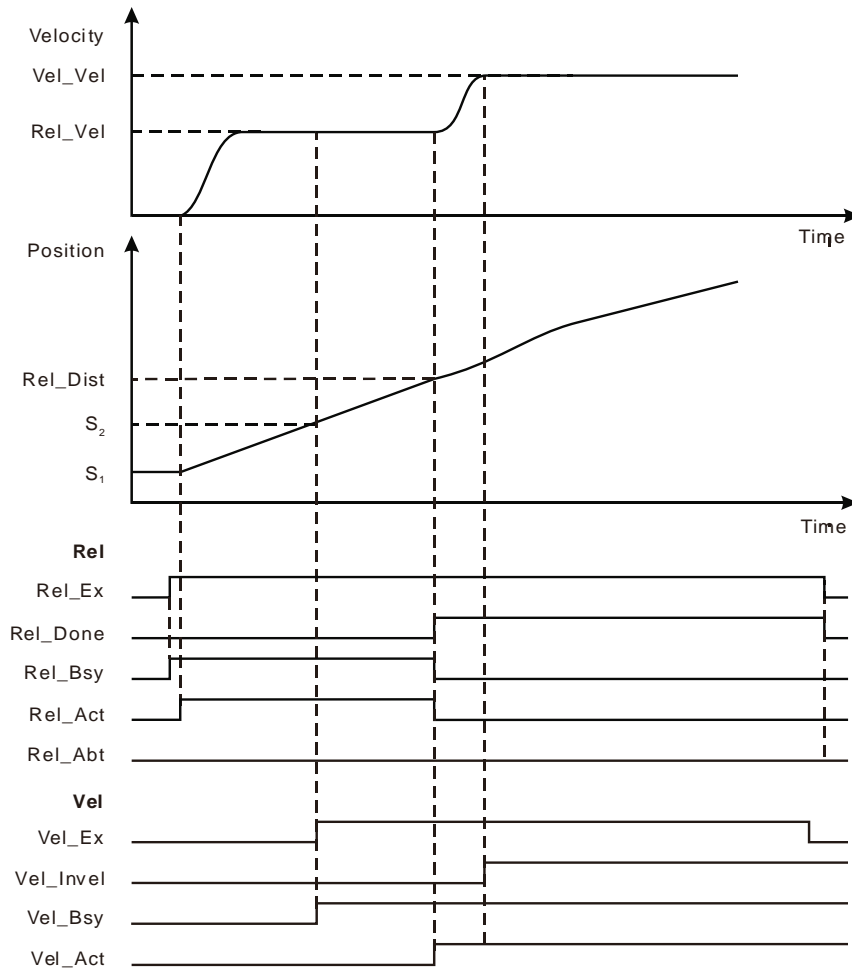

- ❖ As *Rel_Ex* changes from FALSE to TRUE, *Rel_Bsy* changes to TRUE. One period later, *Rel_Act* changes to TRUE. When the target position is not reached, *Vel_Ex* changes from FALSE to TRUE and *Vel_Bsy* changes to TRUE. The axis will wait for the completion of *MC_MoveRelative* execution. After *MC_MoveRelative* execution is completed, *Rel_Done* changes to TRUE, *Rel_Bsy* changes to FALSE and *Rel_Act* changes to FALSE. Meanwhile *Vel_Act* changes to TRUE. At the moment, the velocity is 10000units/second, which is the lower one of the target speeds of the current instruction and the buffered instruction. The velocity instruction execution starts after *MC_MoveRelative* instruction execution is completed. *Vel_Invel* changes to TRUE when the target velocity is reached.

■ **Vel_BM = mcBlendingPrevious**

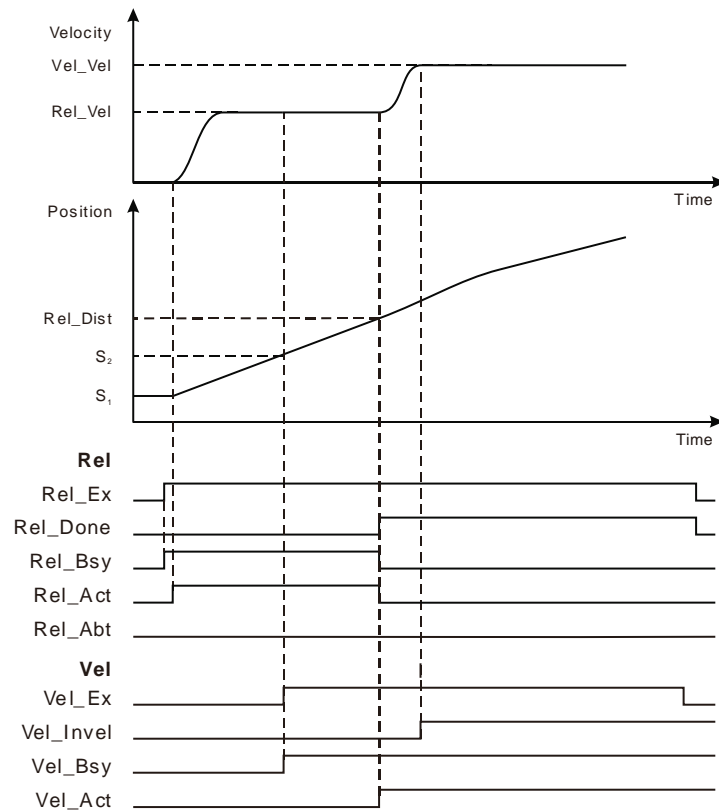

- ❖ As Rel_Ex changes from FALSE to TRUE, Rel_Bsy changes to TRUE. One period later, Rel_Act changes to TRUE. When the target position is not reached, Vel_Ex changes from FALSE to TRUE and Vel_Bsy changes to TRUE. The axis will wait for the completion of MC_MoveRelative execution. After MC_MoveRelative execution is completed, Rel_Done changes to TRUE, Rel_Bsy changes to FALSE, Rel_Act changes to FALSE and meanwhile Vel_Act changes to TRUE. At the moment, the velocity is 10000units/second (which is the target speed of the current instruction). Vel_Invel changes to TRUE when the target velocity is reached.

■ **Vel_BM = mcBlendingNext**

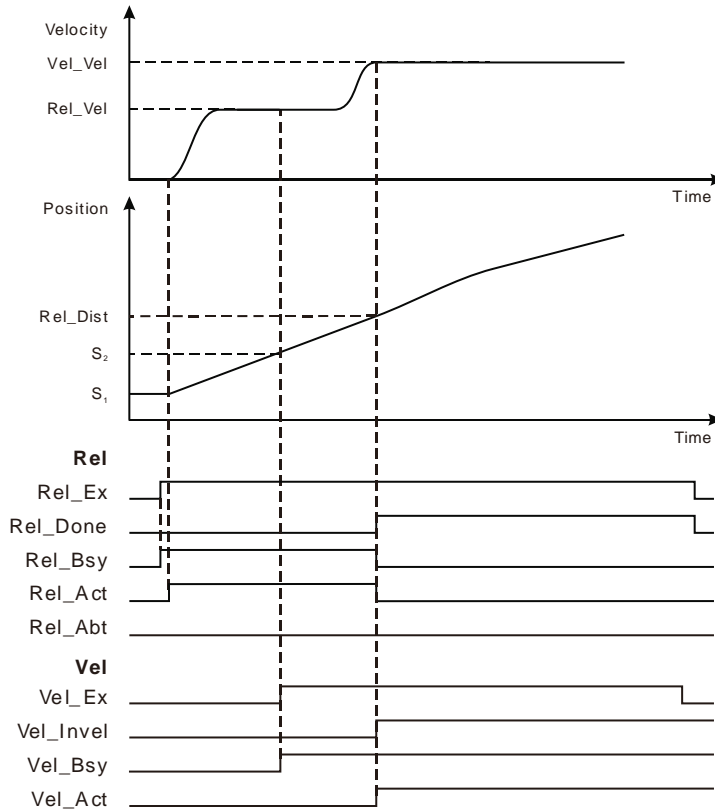

- ❖ As *Rel_Ex* changes from FALSE to TRUE, *Rel_Bsy* changes to TRUE. One period later, *Rel_Act* changes to TRUE. When the target position is not reached, *Vel_Ex* changes from FALSE to TRUE and *Vel_Bsy* changes to TRUE. The axis will wait for the completion of *MC_MoveRelative* execution. After *MC_MoveRelative* execution is completed, *Rel_Done* changes to TRUE, *Rel_Bsy* changes to FALSE, *Rel_Act* changes to FALSE and meanwhile *Vel_Act* changes to TRUE. At the moment, the velocity is 20000units/second (which is the target speed of the buffered instruction). *Vel_Invel* changes to TRUE when the target velocity is reached.

■ **Vel_BM = mcBlendingHigh**

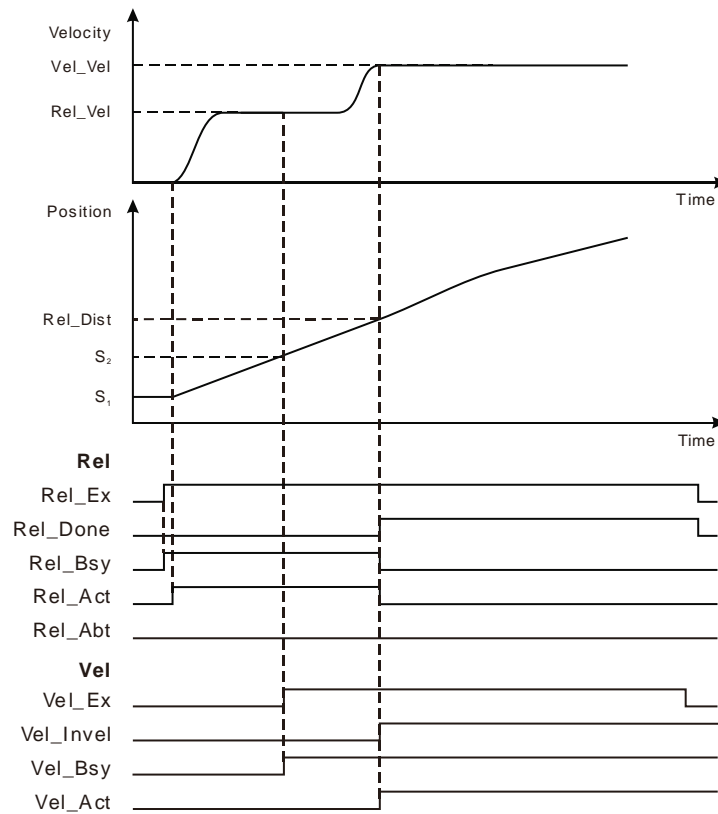

- ❖ As Rel_Ex changes from FALSE to TRUE, Rel_Bsy changes to TRUE. One period later, Rel_Act changes to TRUE. When the target position is not reached, Vel_Ex changes from FALSE to TRUE and Vel_Bsy changes to TRUE. The axis will wait for the completion of MC_MoveRelative execution. After MC_MoveRelative execution is completed, Rel_Done changes to TRUE, Rel_Bsy changes to FALSE and Rel_Act changes to FALSE. At the moment, the velocity is 20000units/second (which is the higher one of the target speeds of the current instruction and the buffered instruction). And then the axis runs according to the velocity, acceleration and deceleration specified by the velocity instruction. Vel_Invel changes to TRUE when the target velocity is reached.

10.4 The State Machine

When DVP-15MC series motion controller utilizes the motion control instruction to control every axis, there is one internal-run state for every axis and axis states are switched by following the state machine instructions below. The state machine defines the motion instructions that can be executed in all states and the states after the motion instructions are executed. Using the motion instructions, users could judge if a certain instruction could be used in current state through the state machine.

The state machine of DVP-15MC series motion controller is illustrated as below and the arrow points to the axis status.

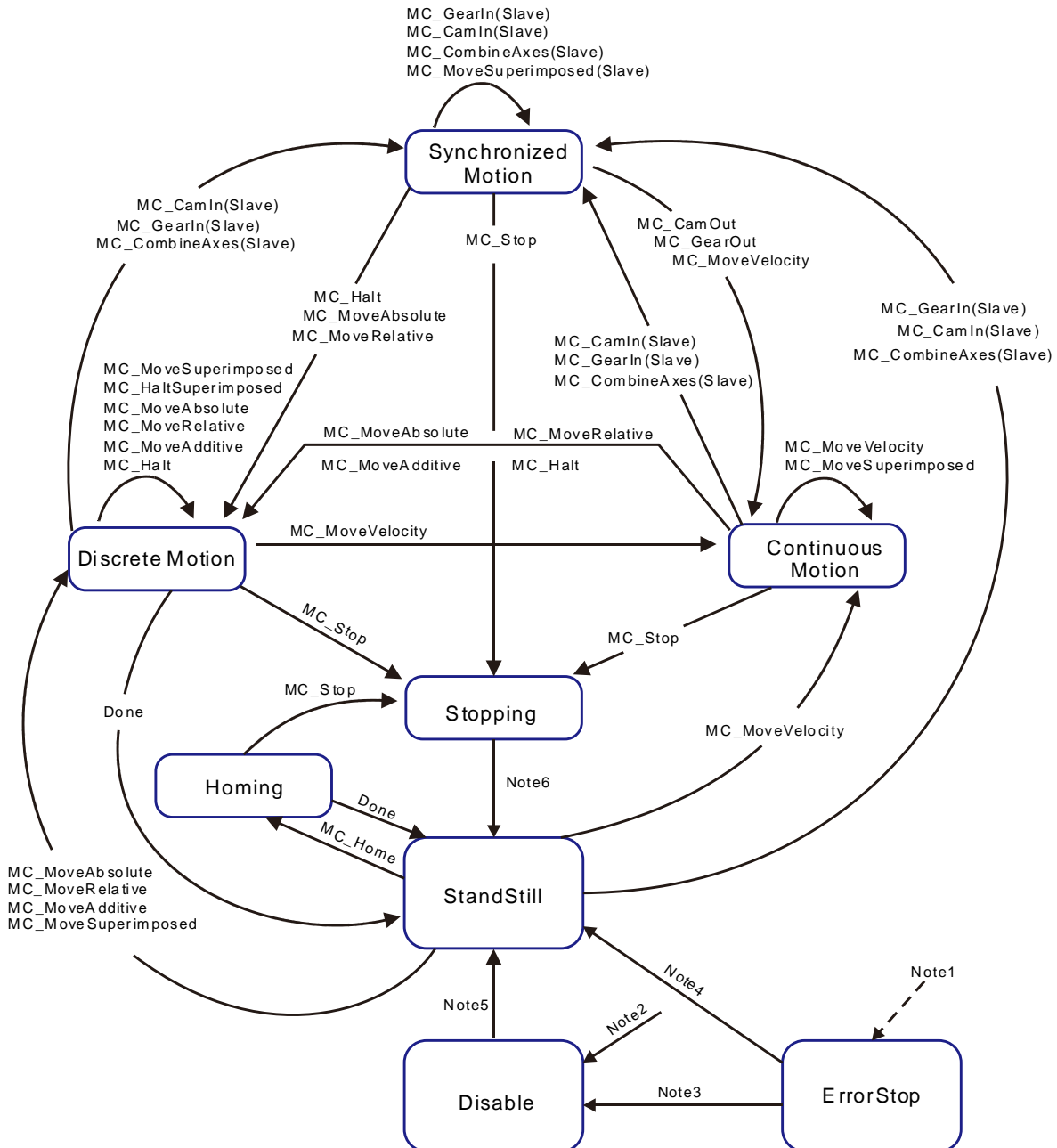

Note1 : The axis in any state will enter the ErrorStop state as long as an error occurs in the axis.

Note2 : The axis enters the Disabled state when no axis error occurs in any state and *Enable* of MC_Power is FALSE.

Note3 : When *Status* of MC_Power is FALSE, the MC_Reset instruction is used to reset the axis to the Disabled state.

Note4 : When *Enable* and *Status* of MC_Power are TRUE, the MC_Reset instruction is used to reset the axis to the Standstill state.

Note5 : The axis enters from Disabled to *Standstill* state when the MC_Power instruction is used to enable the axis and *Status* of MC_Power is TRUE.

Note6 : The axis enters from Stopping to *Standstill* state when *Done* of MC_Stop is TRUE and *Execute* of MC_Stop is FALSE.

No.	Axis state	Indication
1	StandStill	Pre-execution state
2	Disabled	No-execution state
3	ErrorStop	Error state
4	Stopping	Stop state
5	Homing	Homing state
6	Discrete Motion	Discrete motion state
7	Continuous Motion	Continuous motion state
8	Synchronized Motion	Synchronized motion state

Note: Axis state can be judged according to the output parameters of the MC_ReadStatus instruction. Refer to section 11.3.17 for details on the MC_ReadStatus instruction.

MEMO

Chapter 11 Motion Control Instructions

Table of Contents

11.1 Table of Motion Control Instructions	11-4
11.2 About Motion Control Instructions.....	11-6
11.2.1 Composition of A Motion Control Instruction	11-6
11.2.2 Program Languages that Motion Control Instructions Support ..	11-6
11.2.3 Configuration of Motion Control Instructions	11-6
11.3 Single-axis Instructions.....	11-7
11.3.1 MC_Power	11-7
11.3.2 MC_Home	11-16
11.3.3 MC_MoveVelocity	11-21
11.3.4 MC_Halt	11-28
11.3.5 MC_Stop	11-33
11.3.6 MC_MoveRelative	11-38
11.3.7 MC_MoveAdditive	11-46
11.3.8 MC_MoveAbsolute	11-54
11.3.9 MC_MoveSuperimposed	11-63
11.3.10MC_HaltSuperimposed	11-70
11.3.11MC_SetPosition	11-75
11.3.12MC_SetOverride	11-86
11.3.13MC_Reset.....	11-90
11.3.14DMC_SetTorque	11-93
11.3.15MC_ReadAxisError	11-97
11.3.16MC_ReadActualPosition	11-99
11.3.17MC_ReadStatus.....	11-104
11.3.18MC_ReadMotionState	11-109
11.3.19DMC_ReadParameter_Motion	11-114
11.3.20DMC_WriteParameter_Motion	11-119
11.3.21DMC_TouchProbe	11-123
11.3.22DMC_TouchProbeCyclically	11-132
11.3.23DMC_Jog.....	11-136
11.3.24DMC_MoveVelocityStopByPos	11-138
11.3.25DMC_MoveVelocityStopByLinePos.....	11-142
11.3.26DMC_ReadPositionLagStatus.....	11-146
11.3.27DMC_WritePositionLagSetting	11-149
11.3.28DMC_ChangeMechanismGearRatio	11-151
11.3.29DMC_TorqueControl.....	11-153
11.3.30DMC_MoveVelocity	11-158
11.3.31DMC_SwitchSoftLimit.....	11-159

11.4 Multi-axis Instructions	11-161
11.4.1 MC_GearIn	11-161
11.4.2 MC_GearOut	11-167
11.4.3 MC_CombineAxes	11-171
11.4.4 Introduction of Electronic Cam	11-179
11.4.5 MC_CamIn.....	11-180
11.4.6 MC_CamOut.....	11-201
11.4.7 DMC_CamReadPoint.....	11-207
11.4.8 DMC_CamWritePoint	11-211
11.4.9 DMC_CamSet.....	11-213
11.4.10 DMC_CamReadTappetStatus	11-217
11.4.11 DMC_CamReadTappetValue.....	11-222
11.4.12 DMC_CamWriteTappetValue	11-225
11.4.13 DMC_CamAddTappet	11-229
11.4.14 DMC_CamDeleteTappet	11-233
11.5 Application Instructions	11-236
11.5.1 Rotary Cut Technology.....	11-236
11.5.2 Rotary Cut Parameters	11-237
11.5.3 Control Feature of Rotary Cut Function	11-238
11.5.4 Introduction to Cam Curve with Rotary Cut Function	11-239
11.5.5 Rotary-cut Instructions.....	11-243
11.5.5.1 APF_RotaryCut_Init	11-243
11.5.5.2 APF_RotaryCut_In.....	11-246
11.5.5.3 APF_RotaryCut_Out.....	11-248
11.5.6 Application Example of Rotary Cut Instructions.....	11-250
11.6 G Code Instructions.....	11-254
11.6.1 CNC Introduction.....	11-254
11.6.2 G Code Input Format.....	11-254
11.6.3 Explanation of G Code Formats.....	11-256
11.6.4 G Code Functions.....	11-258
11.6.4.1 G90 (Absolute Mode)	11-258
11.6.4.2 G91 (Relative Mode)	11-259
11.6.4.3 G0 (Rapid Positioning)	11-260
11.6.4.4 G1 (Linear Interpolation)	11-263
11.6.4.5 G2 (Clockwise Circular/ Helical Interpolation)	11-267
11.6.4.6 G3 (Anticlockwise Circular /Helical Interpolation)	11-274
11.6.4.7 G17/G18/G19 (Specify Circular Interpolation Plane)	11-280
11.6.4.8 G4 (Dwell Instruction)	11-281
11.6.4.9 G50 (Precise Stop)	11-282
11.6.4.10 G51 (Round path transition)	11-283
11.6.4.11 G52 (Smooth path transition)	11-284
11.6.4.12 M Code	11-286
11.6.5 G Code Instruction.....	11-288
11.6.5.1 DMC_CartesianCoordinate	11-288
11.6.5.2 DMC_ReadMFunction	11-294
11.6.5.3 DMC_ResetMFunction	11-297
11.6.5.4 DMC_SetGOPara.....	11-300

11.6.5.5 DMC_SetG1Para	11-303
11.6.5.6 DMC_SetStartPosition	11-306
11.7 Axes Group Instructions	11-309
11.7.1 DMC_AddAxisToGroup.....	11-309
11.7.2 DMC_RemoveAxisFromGroup.....	11-311
11.7.3 DMC_UngroupAllAxes	11-313
11.7.4 DMC_GroupEnable	11-315
11.7.5 DMC_GroupStop	11-318
11.7.6 DMC_GroupInterrupt	11-324
11.7.7 DMC_GroupContinue	11-329
11.7.8 DMC_MoveDirectAbsolute.....	11-331
11.7.9 DMC_MoveDirectRelative.....	11-336
11.7.10 DMC_MoveLinearAbsolute	11-341
11.7.11 DMC_MoveLinearRelative	11-354
11.7.12 DMC_MoveCircularAbsolute	11-367
11.7.13 DMC_MoveCircularRelative	11-378
11.7.14 DMC_GroupSetOverride	11-389
11.7.15 DMC_GroupReadActualPosition	11-394
11.8 Coordination Instructions	11-396
11.8.1 DMC_ControlAxisByPos	11-396
11.8.2 DMC_NC	11-401

11.1 Table of Motion Control Instructions

Instruction set	Instruction code	Function
Single-axis instructions	<u>MC Power</u>	Power Servo
	<u>MC Home</u>	Homing
	<u>MC MoveVelocity</u>	Velocity
	<u>MC Halt</u>	Temporary Stop
	<u>MC Stop</u>	Stop
	<u>MC MoveRelative</u>	Relative Positioning
	<u>MC MoveAdditive</u>	Additive Positioning
	<u>MC MoveAbsolute</u>	Absolute Positioning
	<u>MC MoveSuperimposed</u>	Superimposed Positioning
	<u>MC HaltSuperimposed</u>	Halt Superimposing
	<u>MC SetPosition</u>	Set Position
	<u>MC SetOverride</u>	Set Override Factors
	<u>MC Reset</u>	Reset
	<u>DMC SetTorque</u>	Set Torque
	<u>MC ReadAxisError</u>	Read Axis Error
	<u>MC ReadActualPosition</u>	Read Actual Position
	<u>MC ReadStatus</u>	Read Axis Status
	<u>MC ReadMotionState</u>	Read Motion State
	<u>DMC ReadParameter_Motion</u>	Read a Parameter
	<u>DMC WriteParameter_Motion</u>	Write a Parameter Value
	<u>DMC TouchProbe</u>	Capture Axis Position
	<u>DMC TouchProbeCyclically</u>	Capture axis position cyclically
	<u>DMC Jog</u>	Jog
	<u>DMC MoveVelocityStopByPos</u>	Stop at a specified phase
	<u>DMC MoveVelocityStopByLinePos</u>	Stop at a specified position
	<u>DMC ReadPositionLagStatus</u>	Detect position lag
	<u>DMC WritePositionLagSetting</u>	Set position lag
	<u>DMC ChangeMechanismGearRatio</u>	Modify axis parameter value
<u>DMC TorqueControl</u>	Torque control	
<u>DMC MoveVelocity</u>	Change velocity and make it valid immediately	
<u>DMC SwitchSoftLimit</u>	Software limit switch	
Multi-axis instructions	<u>MC GearIn</u>	Start E-Gear Operation
	<u>MC GearOut</u>	End E-Gear Operation
	<u>MC CombineAxes</u>	Combine Axes
	<u>MC CamIn</u>	Start E-Cam Operation
	<u>MC CamOut</u>	End E-Cam Operation
	<u>DMC CamReadPoint</u>	Read cam point information
	<u>DMC CamWritePoint</u>	Set cam point parameters

Instruction set	Instruction code	Function
	<u>DMC_CamSet</u>	Make the modified cam point info effective
	<u>DMC_CamReadTappetStatus</u>	Read tappet status
	<u>DMC_CamReadTappetValue</u>	Read tappet parameters
	<u>DMC_CamWriteTappetValue</u>	Set tappet parameters
	<u>DMC_CamAddTappet</u>	Add a tappet point
	<u>DMC_CamDeleteTappet</u>	Delete a tappet point
Application instructions	<u>APF_RotaryCut_Init</u>	Initialize Rotary Cut
	<u>APF_RotaryCut_In</u>	Rotary Cut In
	<u>APF_RotaryCut_Out</u>	Rotary Cut Out
G Code Instructions	<u>DMC_CartesianCoordinate</u>	Cartesian-coordinate robot
	<u>DMC_ReadMFunction</u>	Read M code status
	<u>DMC_ResetMFunction</u>	Reset M code
	<u>DMC_SetG0Para</u>	Set G0 parameter
	<u>DMC_SetG1Para</u>	Set G1 parameter
	<u>DMC_SetStartPosition</u>	Set start position
Axes Group Instructions	<u>DMC_AddAxisToGroup</u>	Add an axis to an axes group
	<u>DMC_RemoveAxisFromGroup</u>	Remove an axis from an axes group
	<u>DMC_UngroupAllAxes</u>	Remove all axes in an axes group
	<u>DMC_GroupEnable</u>	Enable an axes group
	<u>DMC_GroupStop</u>	Stop the current axes group motion
	<u>DMC_GroupInterrupt</u>	Pause the current axes group motion temporarily
	<u>DMC_GroupContinue</u>	Make the paused axes group continue to run
	<u>DMC_MoveDirectAbsolute</u>	Direct absolute positioning
	<u>DMC_MoveDirectRelative</u>	Direct relative positioning
	<u>DMC_MoveLinearAbsolute</u>	Linear absolute interpolation
	<u>DMC_MoveLinearRelative</u>	Linear relative interpolation
	<u>DMC_MoveCircularAbsolute</u>	Circular absolute interpolation
	<u>DMC_MoveCircularRelative</u>	Circular relative interpolation
	<u>DMC_GroupSetOverride</u>	Set override
<u>DMC_GroupReadActualPosition</u>	Read actual position of axes in a group	
Coordination Instructions	<u>DMC_ControlAxisByPos</u>	Incremental position control
	<u>DMC_NC</u>	CNC File Parsing

11.2 About Motion Control Instructions

11.2.1 Composition of A Motion Control Instruction

The instructions starting with “MC_” or “DMC” belong to motion instructions.

11

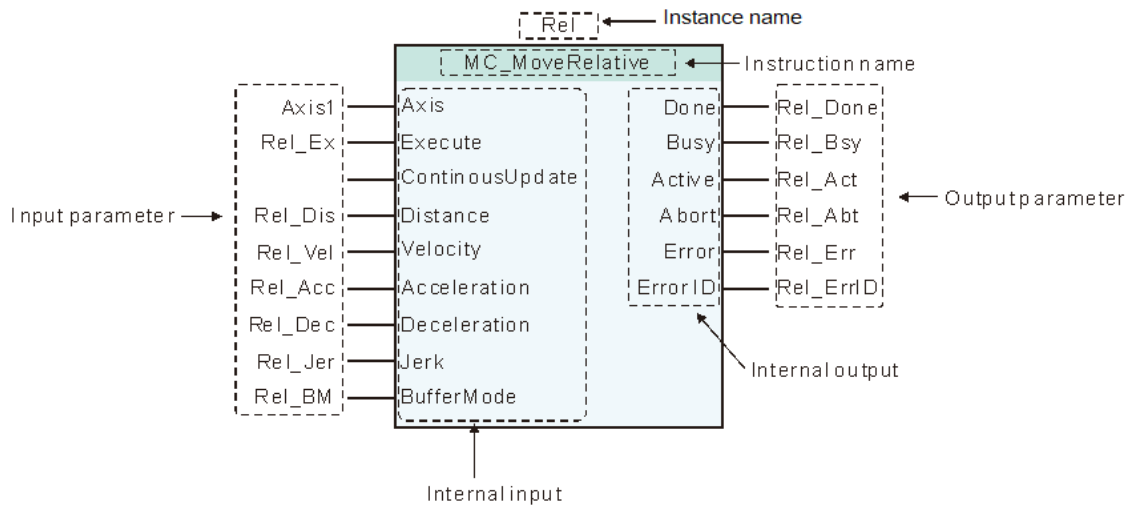

11.2.2 Program Languages that Motion Control Instructions Support

The motion instructions support the following two types of program languages.

For details, refer to the software help file.

- Ladder diagram (LD)
- Structured text (ST)

11.2.3 Configuration of Motion Control Instructions

Motion instructions can only be added to the motion event task. Otherwise, they can not be executed if they are added to other types of tasks.

The following table shows task types and whether motion instruction can be added to these tasks.

Task type		Whether motion intructions can be added or not
Cyclic		No
Freewheeling		No
Triggered by event	Motion event	Yes
	Non-motion event	No

11.3 Single-axis Instructions

11.3.1 MC_Power

FB/FC	Explanation	Applicable model
FB	MC_Power is used to enable or disable the corresponding servo axis.	DVP15MC11T DVP15MC11T-06

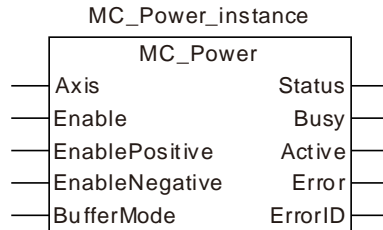

● Input Parameters

Parameter name	Function	Data type	Valid range (Default)	Validation timing
Axis	Specify the number of the axis which is to be controlled.	USINT	Refer to Functions of Section 2.2. (The variable value must be set)	When <i>Enable</i> changes to TRUE
Enable	The instruction is executed when <i>Enable</i> changes from FALSE to TRUE.	BOOL	TRUE or FALSE (FALSE)	When <i>Enable</i> changes to TRUE
EnablePositive	The specified axis is allowed to move forward only under the condition that <i>Enable</i> is TRUE and <i>EnablePositive</i> is also TRUE.	BOOL	TRUE or FALSE (FALSE)	When <i>Enable</i> changes to TRUE
EnableNegative	The specified axis is allowed to move reversely only under the condition that <i>Enable</i> is TRUE and <i>EnableNegative</i> is also TRUE.	BOOL	TRUE or FALSE (FALSE)	When <i>Enable</i> changes to TRUE
Buffermode	Specify the behavior of MC_Power when <i>Enable</i> changes to FALSE	MC_Buffer Mode	0: mcAborting 1: mcBuffered (0)	When <i>Enable</i> changes to TRUE

Note:

Motion control instructions can control servo axes for corresponding motions only after Power ON. When Power OFF, no motion control instructions can be executed.

● Output Parameters

Parameter name	Function	Data type	Valid range
Status	TRUE when the axis is enabled.	BOOL	TRUE/FALSE
Busy	TRUE when the instruction is being executed.	BOOL	TRUE / FALSE
Active	TRUE when the axis is being controlled.	BOOL	TRUE / FALSE
Error	TRUE when an error occurs in execution of the instruction.	BOOL	TRUE / FALSE

Parameter name	Function	Data type	Valid range
ErrorID	Contains the error code when an error occurs. Please refer to section 12.2 for the corresponding error ID.	WORD	

11

● Output Update Timing

Parameter Name	Timing for changing to TRUE	Timing for changing to FALSE
Status	◆ When the axis is enabled.	◆ When <i>Enable</i> changes to FALSE. ◆ When <i>Error</i> changes to TRUE.
Busy	◆ When the instruction is being executed.	◆ When <i>Error</i> changes to TRUE.
Active	◆ The instruction starts controlling the axis.	◆ When <i>Error</i> changes to TRUE.
Error	◆ When an error occurs in the instruction execution or the input parameters for the instruction are illegal.	◆ When an abnormal situation is cleared.

● Output Update Timing Chart

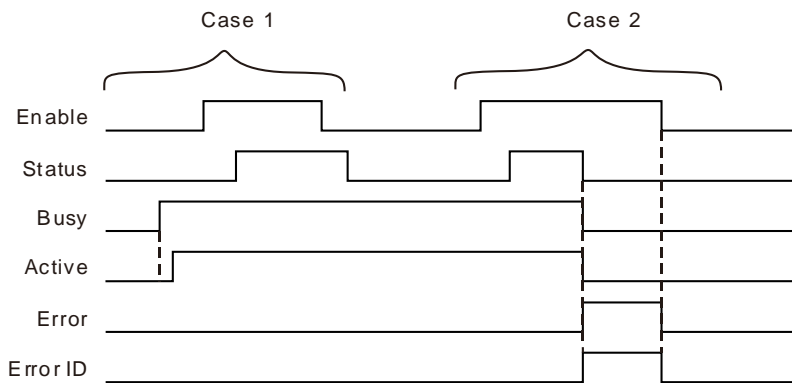

Case 1 : When MC_Power instruction is executed for the first time, *Busy* changes to TRUE and one cycle later, *Active* changes to TRUE. After *Enable* changes from FALSE to TRUE and the axis is enabled, *Status* changes to TRUE. After *Enable* changes from TRUE to FALSE and the axis is disabled, *Status* changes from TRUE to FALSE.

Case 2 : When an error occurs in the execution of the instruction, *Error* changes to TRUE, the corresponding error code is contained in *ErrorID* and meanwhile *Status*, *Busy* and *Active* all change to FALSE. *Error* changes to FALSE when the error is cleared.

● Function

This instruction is used to enable or disable the corresponding servo axis.

1. *Status* will not change to TRUE if the axis is not enabled yet after *Enable* is set to TRUE. Please make sure that *Status* has already changed to TRUE before the axis is started to move.
2. When *Enable* and *EnablePositive* are both TRUE, the axis specified by a motion instruction is allowed to move in the positive direction.
3. When *Enable* is TRUE and *EnablePositive* is FALSE, the axis specified by a motion instruction is prohibited to move in the positive direction. In this case, there will be an error in existence if some motion instruction is used to move the axis forward. If the axis moves from backward to forward, the instruction which is controlling the motion of the axis will be aborted and the axis will stop moving and enter the state of Standstill.
4. When *Enable* and *EnableNegative* are both TRUE, the axis specified by a motion instruction can move in the negative direction.

5. When *Enable* is TRUE and *EnableNegative* is FALSE, the axis specified by a motion instruction is prohibited to move in the negative direction. In this case, there will be an error in existence if some motion instruction is used to move the axis backward. If the axis moves from forward to backward, the instruction which is controlling the motion of the axis will be aborted and the axis will stop moving and enter the state of Standstill.
6. When the axis moves in the positive direction and *EnablePositive* changes from TRUE to FALSE, the axis will decelerate its speed at the deceleration rate specified by the current motion instruction controlling the axis and finally stop at the velocity of 0. When the axis moves in the negative direction and *EnableNegative* changes from TRUE to FALSE, the axis will decelerate its speed at the deceleration rate specified by the current motion instruction controlling the axis and finally stop at the velocity of 0.
7. In principle, only one MC_Power can be used for one axis. If there are two MC_Power instructions in the program where the same axis is controlled, please refer to the execution result of the MC_Power which is executed late.
8. While a motion instruction is controlling the axis, *Enable* of MC_Power changes from TRUE to FALSE and whether the axis enters the Disable state depends on the value of Buffermode.
9. Buffermode

BufferMode specifies the behavior of MC_Power when *Enable* changes from TRUE to FALSE.

Input	BufferMode selection	Function
Enable	0: mcAborting (Interrupt)	When <i>Enable</i> changes from TRUE to FALSE, the axis will stop moving immediately and become disabled (The state machine enters the state of Disabled). Precaution: Be cautious during operation in case of any danger to personnel or devices!
	1: mcBuffered (Waiting)	When <i>Enable</i> changes from TRUE to FALSE, the axis will not enter the Disabled state immediately. Only when the axis stops moving, the state machine goes to the Standstill state first and one cycle later, it enters the Disabled state.



Programming Example 1

The example of MC_Power instruction execution

When *Pwr_En* is TRUE and *Pwr_EnPs* is FALSE, the axis specified by the motion instruction is forbidden to move in the positive direction. While the axis is moving in the positive direction and *Pwr_EnPs* changes from TRUE to FALSE, the axis will decelerate its speed at the deceleration rate specified by the current motion instruction controlling the axis till the velocity of the axis reaches 0.

1. The variables and program

Variable name	Data type	Initial value
<i>Pwr</i>	MC_Power	
<i>Axis1</i>	USINT	1
<i>Pwr_En</i>	BOOL	FALSE
<i>Pwr_EnPs</i>	BOOL	FALSE
<i>Pwr_BM</i>	MC_Buffer_Mode	0
<i>Pwr_Sta</i>	BOOL	
<i>Pwr_Bsy</i>	BOOL	
<i>Pwr_Act</i>	BOOL	
<i>Pwr_Err</i>	BOOL	
<i>Pwr_ErrID</i>	WORD	
<i>Vel</i>	MC_MoveVelocity	

Variable name	Data type	Initial value
Vel_Ex	BOOL	FALSE
Vel_Dir	MC_DIRECTION	1
Vel_BM	MC_Buffer_Mode	0
Vel_Invel	BOOL	
Vel_Bsy	BOOL	
Vel_Act	BOOL	
Vel_Abt	BOOL	
Vel_Err	BOOL	
Vel_ErrID	WORD	

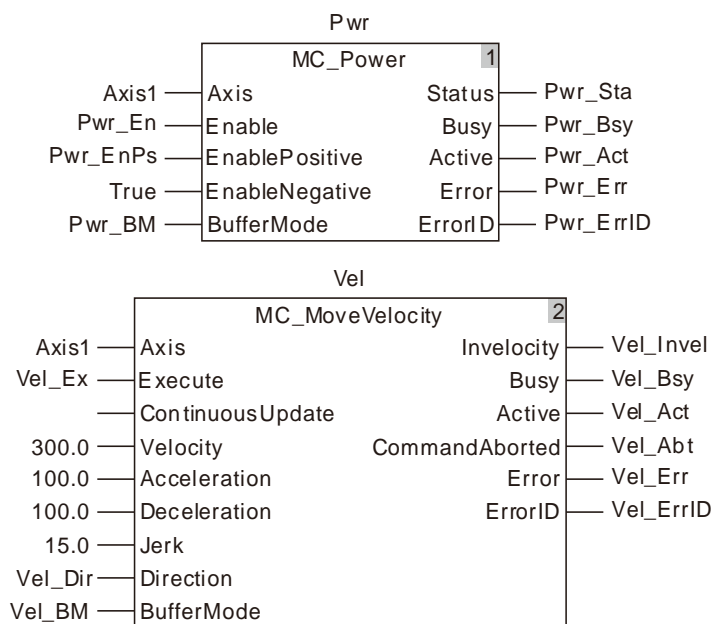

2. Motion Curve and Timing Chart

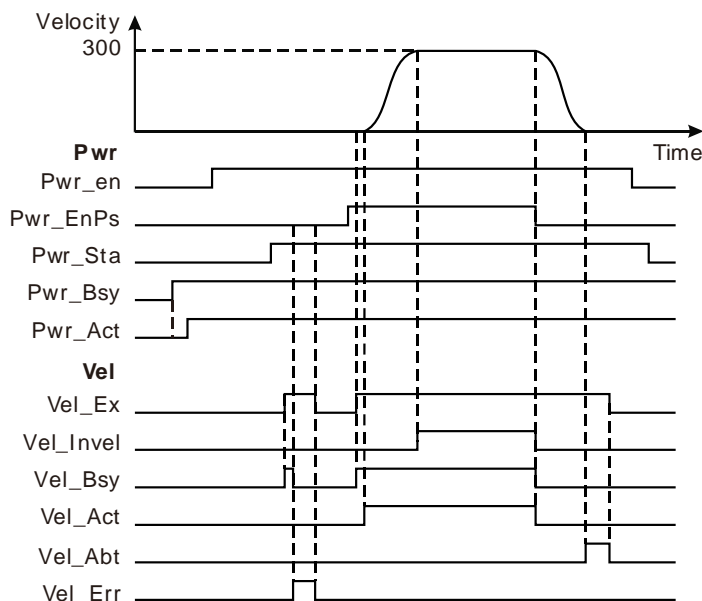

- ❖ When Vel_Ex changes to TRUE for the first time, Vel_Bsy changes to TRUE and one cycle later, Vel_Err changes to TRUE. At this moment, the servo motor could not move because Pwr_EnPs is FALSE.

- ❖ When Pwr_EnPs is TRUE and Vel_Ex changes to TRUE for the second time, Vel_Bsy changes to TRUE; one cycle later, Vel_Act changes to TRUE and the servo motor starts moving in the positive direction. When the servo motor reaches the target velocity, Vel_Invel changes to TRUE.
- ❖ When Pwr_EnPs changes to FALSE, MC_Velocity instruction is aborted and the servo motor begins to decelerate its speed at the deceleration rate specified by MC_Velocity instruction. When the velocity is decreased to 0, CommandAborted changes to TRUE.
- ❖ When Vel_Ex changes to FALSE, Vel_Abt changes to FALSE.
- ❖ When Pwr_En changes to FALSE, Pwr_Sta change to FALSE after the axis is disabled.



Programming Example 2

The example of Vel_BM = 0

When the value of Vel_BM is set to 0 and Pwr_En changes from TRUE to FALSE, the axis will enter the Disabled state and the velocity will be decreased to 0 immediately.

1. The variables and program

Variable name	Data type	Initial value
Pwr	MC_Power	
Axis1	USINT	1
Pwr_En	BOOL	FALSE
Pwr_EnPs	BOOL	FALSE
Pwr_BM	MC_Buffer_Mode	1
Pwr_Sta	BOOL	
Pwr_Bsy	BOOL	
Pwr_Act	BOOL	
Pwr_Err	BOOL	
Pwr_ErrID	WORD	
Vel	MC_MoveVelocity	
Vel_Ex	BOOL	FALSE
Vel_Dir	MC_DIRECTION	1
Vel_BM	MC_Buffer_Mode	0
Vel_Invel	BOOL	
Vel_Bsy	BOOL	
Vel_Act	BOOL	
Vel_Abt	BOOL	
Vel_Err	BOOL	
Vel_ErrID	WORD	
Stp	MC_Stop	
Stp_Ex	BOOL	FALSE
Stp_Done	BOOL	
Stp_Bsy	BOOL	
Stp_Act	BOOL	
Stp_Abt	BOOL	
Stp_Err	BOOL	
Stp_ErrID	WORD	

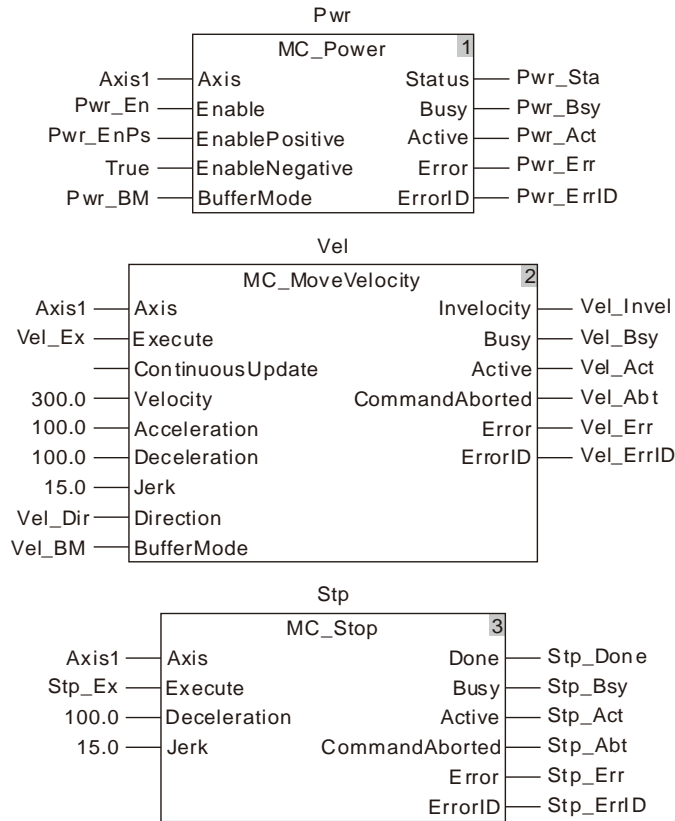

2. Motion Curve and Timing Chart

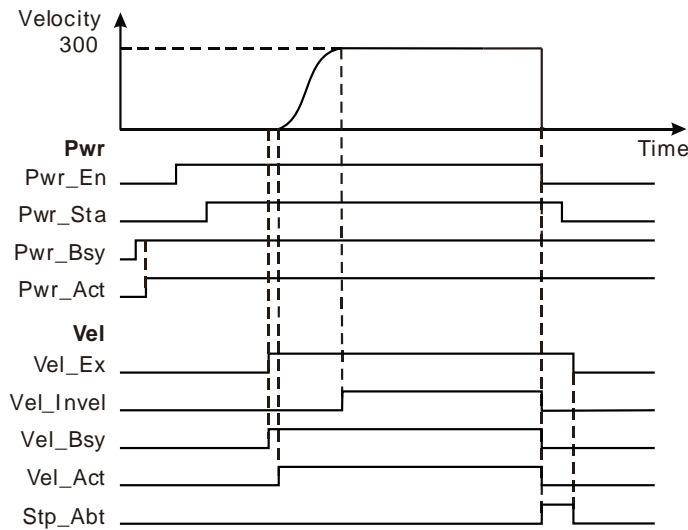

- ❖ When Vel_Ex changes to TRUE, the servo motor starts moving in the positive direction. When the speed of the servo motor reaches target velocity, Vel_Invel changes to TRUE.
- ❖ When Pwr_En changes to FALSE, the speed of the servo motor is decreased to 0 and the axis enters the Standstill state right away. At the same time, Vel_Abt changes to TRUE and Vel_Bsy and Vel_Act change to FALSE. Pwr_Sta changes to FALSE after the axis is disabled.
- ❖ When Vel_Ex changes to FALSE, Vel_Abt changes to FALSE.



Programming Example 3

The example of Vel_BM =1

When the value of *Buffermode* is set to 1 and *Enable* changes from TRUE to FALSE, there will be no change in *Status* of MC_Power unless the axis stops moving. When the axis stops moving, the axis will enter the Standstill state first and one cycle later, it will go to the Disabled state.

1. The variables and program

Variable name	Data type	Initial value
Pwr	MC_Power	
Axis1	USINT	1
Pwr_En	BOOL	FALSE
Pwr_EnPs	BOOL	FALSE
Pwr_BM	MC_Buffer_Mode	0
Pwr_Sta	BOOL	
Pwr_Bsy	BOOL	
Pwr_Act	BOOL	
Pwr_Err	BOOL	
Pwr_ErrID	WORD	
Vel	MC_MoveVelocity	
Vel_Ex	BOOL	FALSE
Vel_Dir	MC_DIRECTION	1
Vel_BM	MC_Buffer_Mode	0
Vel_Invel	BOOL	
Vel_Bsy	BOOL	
Vel_Act	BOOL	
Vel_Abt	BOOL	
Vel_Err	BOOL	
Vel_ErrID	WORD	
Stp	MC_Stop	
Stp_Ex	BOOL	FALSE
Stp_Done	BOOL	
Stp_Bsy	BOOL	
Stp_Act	BOOL	
Stp_Abt	BOOL	
Stp_Err	BOOL	
Stp_ErrID	WORD	

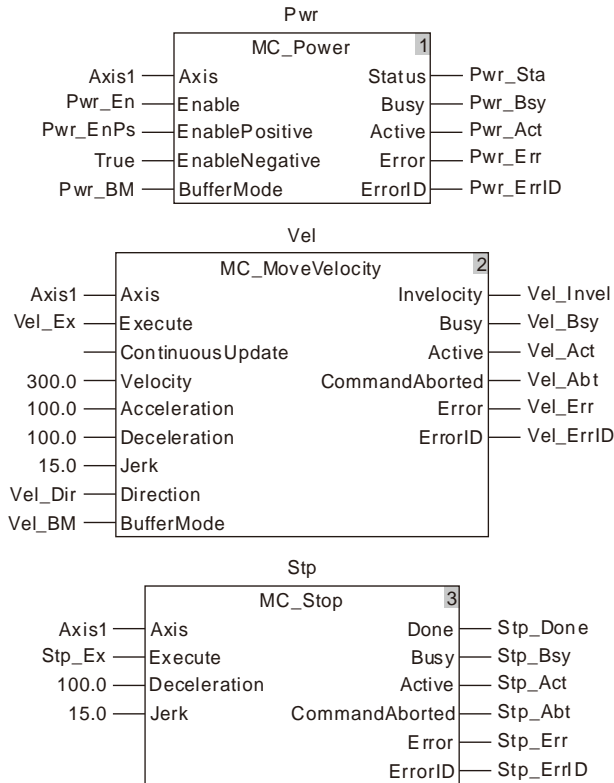

2. Motion Curve and Timing Chart

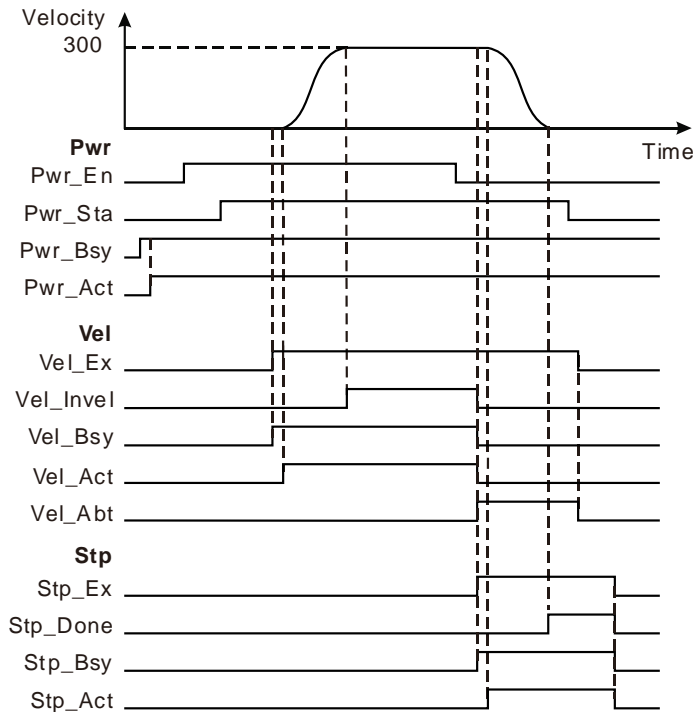

- ❖ When Vel_Ex changes to TRUE, Vel_Bsy changes to TRUE; one cycle later, Vel_Act changes to TRUE and the servo motor starts moving in the positive direction. When the speed of the servo motor reaches the target velocity, Vel_Invel changes to TRUE.
- ❖ When Pwr_En changes to FALSE, the axis will not enter the Standstill state immediately. When Stp_Ex changes to TRUE, Stp_Bsy changes to TRUE; one cycle later, Stp_Act changes to TRUE and the servo motor begins to decelerate. When the speed of the servo motor drops to

0, Stp _Done changes to TRUE. Meanwhile, the axis enters the Standstill state and Pwr_Sta changes to FALSE. One cycle later, the axis goes to the Disabled state.

- ❖ When Vel _Ex changes to FALSE, Vel _Abt changes to FALSE.
- ❖ When Stp _Ex changes to FALSE, Stp _Done, Stp _Bsy and Stp _Act change to FALSE.

11.3.2 MC_Home

FB/FC	Explanation	Applicable model
FB	MC_Home controls the servo motor to perform the homing action according to the set mode and velocity.	DVP15MC11T DVP15MC11T-06

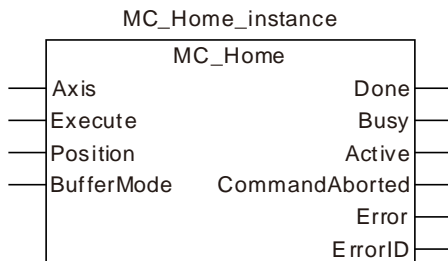

● **Input Parameters**

Parameter name	Function	Data type	Valid range (Default)	Validation timing
Axis	Specify the number of the axis which is to be controlled.	USINT	Refer to Functions of Section 2.2. (The variable value must be set)	When <i>Execute</i> changes from FALSE to TRUE
Execute	The instruction is executed when <i>Execute</i> changes from FALSE to TRUE.	BOOL	TRUE or FALSE (FALSE)	
Position	The servo home point offset, Unit: unit.	LREAL	Negative number, positive number and 0 (0)	When <i>Execute</i> changes from FALSE to TRUE
BufferMode	Reserved	-	-	-

● **Output Parameters**

Parameter name	Function	Data type	Valid range
Done	TRUE when the homing is completed.	BOOL	TRUE / FALSE
Busy	TRUE when the instruction is being executed.	BOOL	TRUE / FALSE
Active	TRUE when the axis is being controlled.	BOOL	TRUE / FALSE
CommandAborted	TRUE when the instruction is aborted.	BOOL	TRUE / FALSE
Error	TRUE when an error occurs in execution of the instruction.	BOOL	TRUE / FALSE
ErrorID	Contains the error code when an error occurs. Please refer to section 12.2 for the corresponding error ID.	WORD	

● **Output Update Timing**

Parameter Name	Timing for changing to TRUE	Timing for changing to FALSE
Done	◆ When homing is completed.	◆ When <i>Execute</i> changes from TRUE to FALSE after the instruction execution is completed. ◆ <i>Done</i> changes to TRUE when the instruction execution is completed after <i>Execute</i> changes from TRUE to FALSE during the instruction

Parameter Name	Timing for changing to TRUE	Timing for changing to FALSE
		execution. One cycle later, <i>Done</i> changes to FALSE.
Busy	◆ When <i>Execute</i> changes to TRUE.	◆ When <i>Done</i> changes to TRUE. ◆ When <i>Error</i> changes to TRUE. ◆ When <i>CommandAborted</i> changes to TRUE.
Active	◆ When the instruction starts to control the axis.	◆ When <i>Done</i> changes to TRUE. ◆ When <i>Error</i> changes to TRUE. ◆ When <i>CommandAborted</i> changes to TRUE.
CommandAborted	◆ When this instruction execution is aborted by other motion control instruction.	◆ When <i>Execute</i> changes from TRUE to FALSE. ◆ <i>CommandAborted</i> is set to TRUE when the instruction is aborted after <i>Execute</i> changes from TRUE to FALSE during the instruction execution. One cycle later, <i>CommandAborted</i> changes to FALSE.
Error	◆ When an error occurs in the instruction execution or the input parameters for the instruction are illegal.	◆ When <i>Execute</i> changes from TRUE to FALSE.

● Output Update Timing Chart

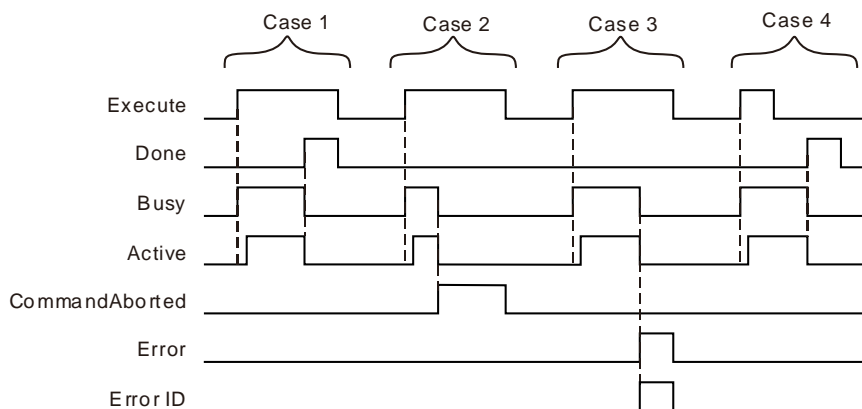

Case 1 : When *Execute* changes from FALSE to TRUE, *Busy* changes to TRUE and one cycle later, *Active* changes to TRUE. When the positioning is completed, *Done* changes to TRUE and meanwhile *Busy* and *Active* change to FALSE.

Case 2 : When the instruction is aborted by other instruction after *Execute* changes from FALSE to TRUE, *CommandAborted* changes to TRUE and meanwhile, *Busy* and *Active* change to FALSE. When *Execute* changes from TRUE to FALSE, *CommandAborted* changes to FALSE.

Case 3 : When an error occurs such as axis alarms or Offline after *Execute* changes from FALSE to TRUE, *Error* changes to TRUE and *ErrorID* shows corresponding error code. Meanwhile, *Busy* and *Active* change to FALSE. *Error* changes to FALSE when *Execute* changes from TRUE to FALSE.

Case 4 : *Done* changes to TRUE when the instruction execution is completed after *Execute* changes from TRUE to FALSE in the course of execution of the instruction. Meanwhile, *Busy* and *Active* change to FALSE and one cycle later, *Done* changes to FALSE.

11

● **Function**

1. According to the set homing mode, the MC_Hme instruction is used for connecting the home switch and positive limit switch or negative limit switch to the external input points of the servo drive so as to achieve the homing function.
2. For real axes, the homing mode and phase-1 speed and phase-2 speed of the homing are set in the software axis parameter setting. See Appendix D for details on homing modes. For virtual axes, the homing mode can only be set to mode 35.
3. The instruction can be executed only while the axis is in Stanstill state. Otherwise, an error will occur.
4. Position parameter defines the offset between the mechanical zero point and servo reference zero point as the figure below:

A	Mechanical zero point, where the photoelectric sensor is.
▼	The position is where the servo is after execution of the instruction is finished.

For different *Position* value, the servo will eventually stop at the mechanical point A under the control of this instruction. But the reference zero point of the servo position will change as shown below.

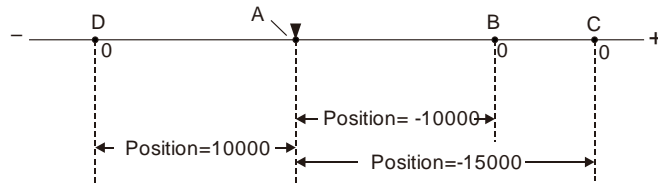

As *Position*=10000, the reference zero point of the servo position is point D and point A position is 10000;
 As *Position*=-15000, the reference zero point of the servo position is point C and point A position is -15000;
 As *Position*=-10000, the reference zero point of the servo position is point B and point A position is -10000.

Programming Example

Select an appropriate homing mode via the positions of the mechanism and photoelectric switch. When *Hom_Ex* changes from FALSE to TRUE, the motion controller controls the servo motor to rotate and drive the mechanism to return to the mechanical zero point position A.

- Hardware wiring

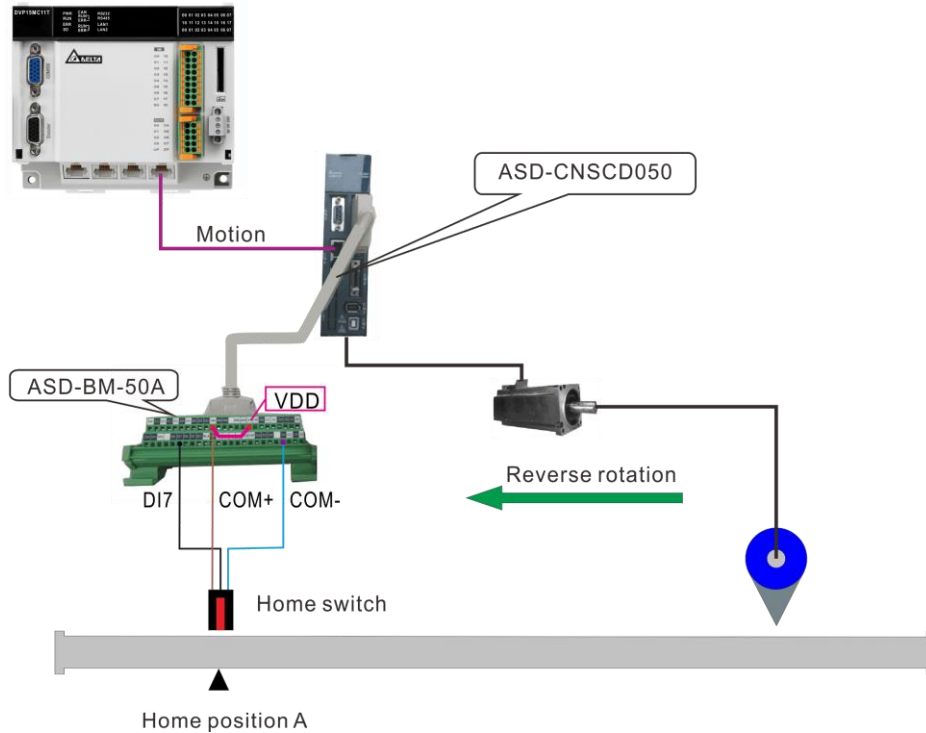

Note:

- During wiring, COM+ and VDD must be shorted.
- Of the photoelectric switch, the brown terminal (24V+) is connected to COM+, the blue terminal (0V) is connected to COM- and the black terminal (Signal cable) is connected to DI7.
- The DI7 function is set to the home switch, i.e. P2-16 is set to 124.

- Homing mode selection

It can be seen from the hardware wiring figure that the mechanism regards the home switch position as the mechanical zero point position A. The home switch is OFF before searching for the home. While the mechanism is searching for the home point, the servo rotates reversely at beginning and homing mode 21 can be selected to achieve the homing.

The settings for homing in the corresponding axis parameters are as follows.

Homing mode	21
The first-phase speed (the speed for finding the home switch, Unit: r/m)	100
The second-phase speed (The speed from finding the home switch to reaching the mechanical zero point, Unit: r/m)	10

Note: The set axis parameters are valid after being downloaded.

● The variable table and program

Variable name	Data type	Initial value
Hom	MC_Home	
Axis1	USINT	1
Hom_Ex	BOOL	FALSE
Hom_Done	BOOL	
Hom_Bsy	BOOL	
Hom_Act	BOOL	
Hom_Abt	BOOL	
Hom_Err	BOOL	
Hom_ErrID	WORD	

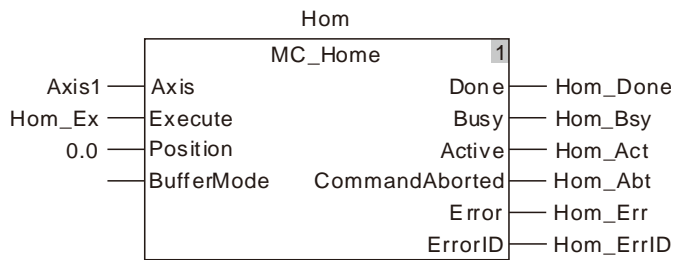

- ❖ When Hom_Ex changes from FALSE to TRUE, the motion controller controls the motion of the servo motor. The mechanism starts to run reversely, rotates forward after reaching the home switch and then stops at the mechanical zero point. And the mechanism is driven to return to the mechanical zero point A by doing so.
- ❖ When the home switch is met, the homing is completed and Hom_Done is set to ON.

11.3.3 MC_MoveVelocity

FB/FC	Explanation	Applicable model
FB	MC_MoveVelocity controls the axis motion based on the set acceleration and deceleration till the set target velocity is reached and then the axis moves at the set speed.	DVP15MC11T DVP15MC11T-06

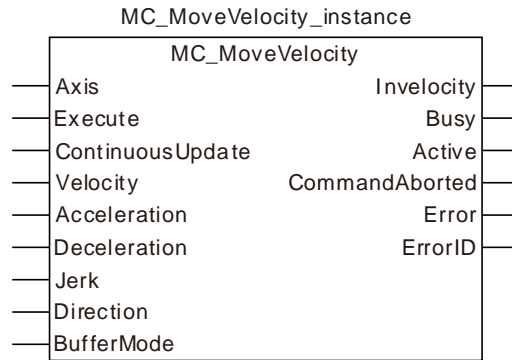

● Input Parameters

Parameter name	Function	Data type	Valid range (Default)	Validation timing
Axis	Specify the number of the axis which is to be controlled.	USINT	Refer to Functions of Section 2.2. (The variable value must be set)	When <i>Execute</i> changes from FALSE to TRUE
Execute	The instruction is executed when <i>Execute</i> changes from FALSE to TRUE.	BOOL	TRUE or FALSE (FALSE)	-
ContinuousUpdate	Reserved	-	-	-
Velocity	Specify the target speed (Unit: unit/second)	LREAL	Positive number, Negative number and 0 (The variable value must be set)	When <i>Execute</i> changes from FALSE to TRUE
Acceleration	Specify the target acceleration (Unit: unit/second ²)	LREAL	Positive number (The variable value must be set)	When <i>Execute</i> changes from FALSE to TRUE
Deceleration	Specify the target deceleration (Unit: unit/second ²)	LREAL	Positive number (The variable value must be set)	When <i>Execute</i> changes from FALSE to TRUE
Jerk	Specify the change rate of target acceleration or deceleration. (Unit: Unit/s ³)	LREAL	Positive number (The variable value must be set)	When <i>Execute</i> changes from FALSE to TRUE
Direction	Specify the rotation direction 1: Positive direction 3: Negative direction 4: Current direction (When the motor is in stop state, the current direction is the positive direction.)	MC_Direction	1: mcPositiveDirection, 3: mcNegativeDirection 4: mcCurrentDirection, (1)	When <i>Execute</i> changes from FALSE to TRUE

Parameter name	Function	Data type	Valid range (Default)	Validation timing
BufferMode	Specify the behavior when executing two instructions. 0: Aborting 1: Buffered 2: BlendingLow 3: BlendingPrevious 4: BlendingNext 5: BlendingHigh	MC_Buffer_Mode	0: mcAborting 1: mcBuffered 2: mcBlendingLow 3: mcBlendingPrevious 4: mcBlendingNext 5: mcBlendingHigh (0)	When <i>Execute</i> changes from FALSE to TRUE

Notes:

1. MC_MoveVelocity instruction is executed when *Execute* changes from FALSE to TRUE. The instruction can be re-executed when *Execute* of the instruction changes from FALSE to TRUE again no matter whether the instruction execution is completed. At the moment, the parameters including *Velocity*, *Acceleration*, *Deceleration*, *Jerk* and *Direction* are effective again and other parameters are ineffective. When the velocity instruction has the BufferMode relationship with other motion instruction, the parameters will be valid after the instruction parameters are changed and the instruction is re-triggered. The previous buffermode relation remains and the transition speed will be re-calculated.
2. *Invelocity* remains TRUE even if the target speed is changed through MC_SetOverride after the velocity instruction execution is completed (that is, *Invelocity* changes from FALSE to TRUE.) *Invelocity* will change from FALSE to TRUE when the new target speed is reached after the target speed is changed through MC_SetOverride before the execution of MC_MoveVelocity is completed (when *Invelocity* is FALSE.)
3. Refer to section 10.2 for the relation among *Position*, *Velocity*, *Acceleration* and *Jerk*.
4. Refer to section 10.3 for details on *BufferMode*.

● **Output Parameters**

Parameter name	Function	Data type	Valid range
Invelocity	TRUE when the target velocity is reached.	BOOL	TRUE / FALSE
Busy	TRUE when the instruction is being executed.	BOOL	TRUE / FALSE
Active	TRUE when the axis is being controlled.	BOOL	TRUE / FALSE
CommandAborted	TRUE when the instruction is aborted.	BOOL	TRUE / FALSE
Error	TRUE when an error occurs in execution of the instruction.	BOOL	TRUE / FALSE
ErrorID	Contains the error code when an error occurs. Please refer to section 12.2 for the corresponding error ID.	WORD	

● **Output Update Timing**

Parameter Name	Timing for changing to TRUE	Timing for changing to FALSE
Invelocity	◆ When the target velocity is reached.	◆ When <i>CommandAborted</i> changes to TRUE ◆ When <i>Error</i> changes to TRUE ◆ <i>Invelocity</i> changes to FALSE immediately when <i>Execute</i> changes from FALSE to TRUE again if the input parameter values are revised after the target velocity is reached. If the input parameter values are not changed after the instruction execution is completed and <i>Execute</i> changes from FALSE to TRUE again, <i>Invelocity</i> changes to FALSE immediately and <i>Invelocity</i> changes to TRUE in the next cycle.

Parameter Name	Timing for changing to TRUE	Timing for changing to FALSE
Busy	◆ When <i>Execute</i> changes to TRUE.	◆ When <i>Error</i> changes to TRUE. ◆ When <i>CommandAborted</i> changes to TRUE.
Active	◆ When the instruction starts to control the axis.	◆ When <i>Error</i> changes to TRUE. ◆ When <i>CommandAborted</i> changes to TRUE.
CommandAborted	◆ When this instruction execution is aborted by other motion control instruction.	◆ When <i>Execute</i> changes from TRUE to FALSE. ◆ <i>CommandAborted</i> is set to TRUE when the instruction is aborted by other instruction after <i>Execute</i> changes from TRUE to FALSE during the instruction execution. One cycle later, <i>CommandAborted</i> changes to FALSE.
Error	◆ When an error occurs in the instruction execution or the input parameters for the instruction are illegal.	◆ When <i>Execute</i> changes from TRUE to FALSE.

● Output Update Timing Chart

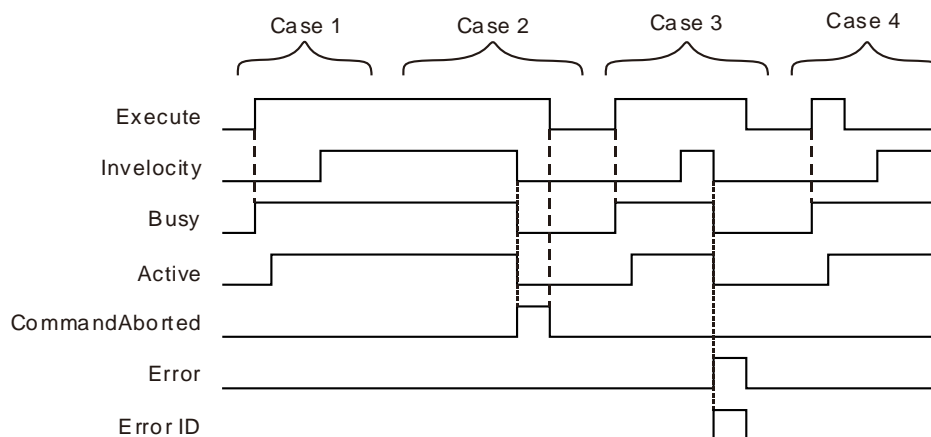

- Case 1 :** When *Execute* changes from FALSE to TRUE, *Busy* changes to TRUE and one cycle later, *Active* changes to TRUE. When the target velocity is reached, *Invelocity* changes to TRUE and meanwhile, *Busy* and *Active* remain TRUE.
- Case 2 :** When *Execute* is TRUE, the instruction is aborted by other instruction and *CommandAborted* changes to TRUE. Meanwhile, *Invelocity*, *Busy* and *Active* change to FALSE. When *Execute* changes from TRUE to FALSE, *CommandAborted* changes to FALSE.
- Case 3 :** When an error occurs such as parameter error while *Execute* is TRUE, *Error* changes to TRUE and *ErrorID* shows corresponding error code. Meanwhile, *Invelocity*, *Busy* and *Active* change to FALSE. *Error* changes to FALSE when *Execute* changes from TRUE to FALSE.
- Case 4 :** In the course of execution of the instruction, *Invelocity* changes to TRUE when the target velocity is reached after *Execute* changes from TRUE to FALSE. Meanwhile, *Busy* and *Active* remain TRUE.

● Function

MC_MoveVelocity controls the axis to speed up or down according to the set acceleration, deceleration and jerk till the set target velocity is reached and after that the axis moves at the target speed. The direction of the uniform motion is determined by the input parameter *Direction*. The *Direction* value 1 indicates the positive direction, 3 is the negative direction and 4 is the current direction. If *Direction* value is set to 4 and the axis is in STOP state before the MC_MoveVelocity instruction is executed, the axis will move in the positive direction.

Programming Example 1

The programming example is as follows when one MC_MoveVelocity instruction is used.

1. The variable table and program

Variable name	Data type	Initial value
Pwr	MC_Power	
Axis1	USINT	1
Pwr_BM	MC_Buffer_Mode	1
Pwr_Sta	BOOL	
Pwr_Bsy	BOOL	
Pwr_Act	BOOL	
Pwr_Err	BOOL	
Pwr_ErrID	WORD	
Vel	MC_MoveVelocity	
Vel_Ex	BOOL	FALSE
Vel_Dir	MC_DIRECTION	1
Vel_BM	MC_Buffer_Mode	0
Vel_Invel	BOOL	
Vel_Bsy	BOOL	
Vel_Act	BOOL	
Vel_Abt	BOOL	
Vel_Err	BOOL	
Vel_ErrID	WORD	

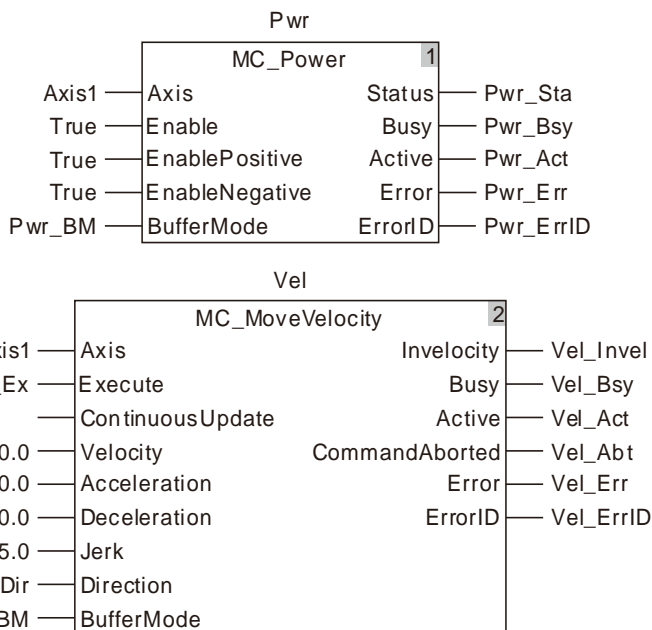

2. Motion Curve and Timing Chart

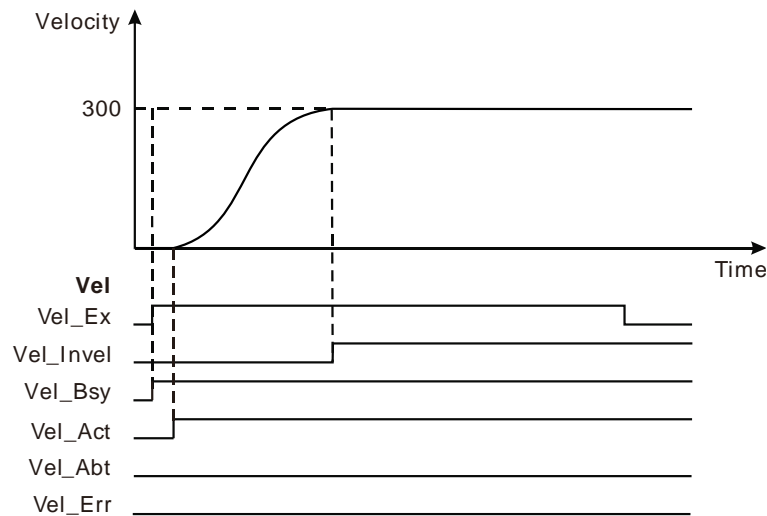

- ❖ When Vel_Ex changes from FALSE to TRUE, Vel_Bsy changes to TRUE. One cycle later, Vel_Act changes to TRUE and the execution of the velocity instruction starts. When the target velocity is reached, Vel_Invel changes to TRUE and Vel_Bsy and Vel_Act remain TRUE.
- ❖ When Vel_Ex changes from TRUE to FALSE, Vel_Invel, Vel_Bsy and Vel_Act remain TRUE.



Programming Example 2

Below is the example that one MC_MoveVelocity instruction aborts another MC_MoveVelocity instruction.

1. The variable table and program

Variable name	Data type	Initial value
Pwr	MC_Power	
Axis1	USINT	1
Pwr_BM	MC_Buffer_Mode	1
Pwr_Sta	BOOL	
Pwr_Bsy	BOOL	
Pwr_Act	BOOL	
Pwr_Err	BOOL	
Pwr_ErrID	WORD	
Vel1	MC_MoveVelocity	
Vel1_Ex	BOOL	FALSE
Vel1_Dir	MC_DIRECTION	1
Vel1_BM	MC_Buffer_Mode	0
Vel1_Invel	BOOL	
Vel1_Bsy	BOOL	
Vel1_Act	BOOL	
Vel1_Abt	BOOL	
Vel1_Err	BOOL	
Vel1_ErrID	WORD	
Vel2	MC_MoveVelocity	
Vel2_Ex	BOOL	FALSE
Vel2_Dir	MC_DIRECTION	1
Vel2_BM	MC_Buffer_Mode	0

Variable name	Data type	Initial value
Vel2_Invel	BOOL	
Vel2_Bsy	BOOL	
Vel2_Act	BOOL	
Vel2_Abt	BOOL	
Vel2_Err	BOOL	
Vel2_ErrID	WORD	

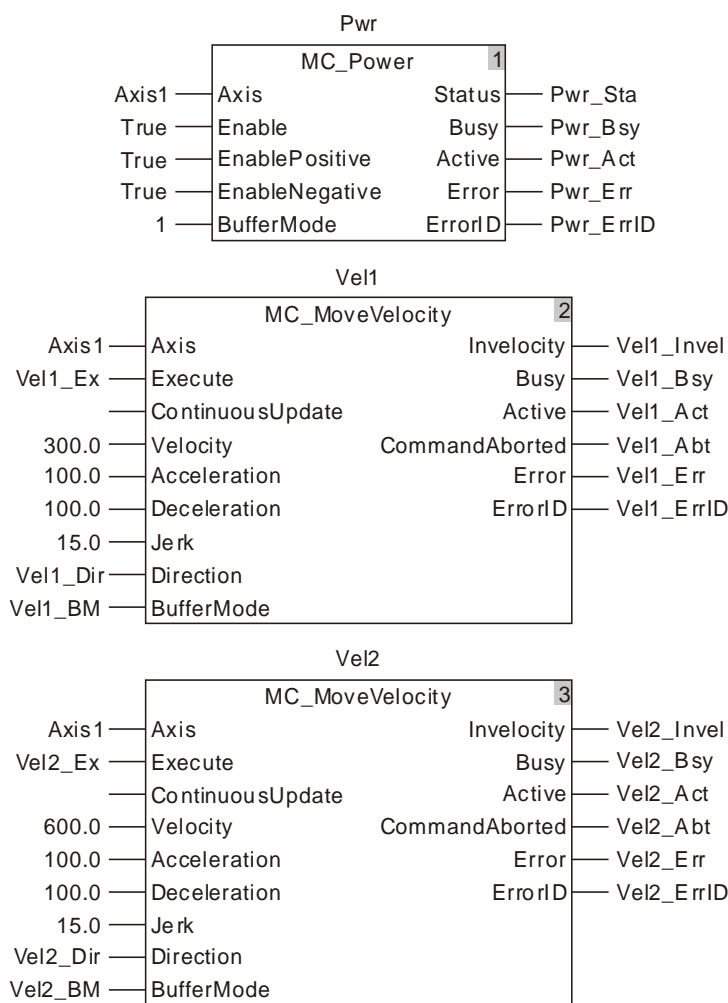

2. Motion Curve and Timing Chart

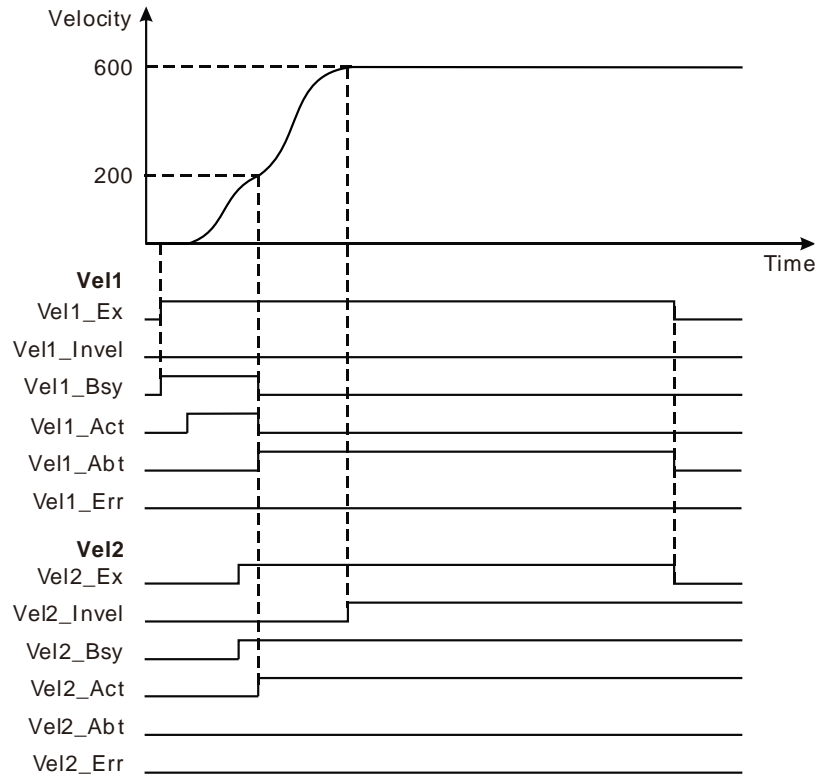

- ❖ When Vel1_Ex changes from FALSE to TRUE, Vel1_Bsy changes to TRUE. One cycle later, Vel1_Act changes to TRUE and the first MC_MoveVelocity instruction starts being executed. When the target velocity is not reached, Vel2_Ex changes from FALSE to TRUE and Vel2_Bsy changes to TRUE. One cycle later, Vel2_Act changes to TRUE, the first MC_MoveVelocity instruction is aborted, Vel1_Abt changes to TRUE and the axis starts to perform the second MC_MoveVelocity instruction. When the target velocity is reached, Vel2_Invel changes to TRUE and meanwhile, Vel2_Bsy and Vel2_Act remain TRUE.
- ❖ When Vel1_Ex changes from TRUE to FALSE, Vel1_Abt changes to FALSE. When Vel2_Ex changes from TRUE to FALSE, Vel2_Invel, Vel2_Bsy and Vel2_Act remain TRUE.

11.3.4 MC_Halt

FB/FC	Explanation	Applicable model
FB	MC_Halt is used to make the axis decelerate at a given deceleration rate till it stops.	DVP15MC11T DVP15MC11T-06

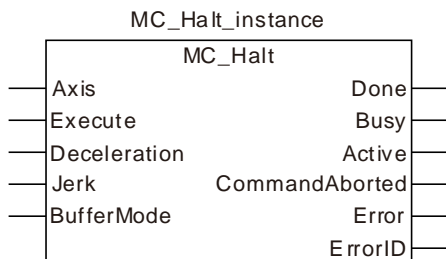

● Input Parameters

Parameter name	Function	Data type	Valid range (Default)	Validation timing
Axis	Specify the number of the axis which is to be controlled	USINT	Refer to Functions of Section 2.2. (The variable value must be set)	When <i>Execute</i> changes from FALSE to TRUE
Execute	The instruction is executed when <i>Execute</i> changes from FALSE to TRUE.	BOOL	TRUE or FALSE (FALSE)	-
Deceleration	Specify the target deceleration rate. (Unit: Unit/s ²)	LREAL	Positive number (The variable value must be set)	When <i>Execute</i> changes from FALSE to TRUE
Jerk	Specify the change rate of the target acceleration or deceleration. (Unit: Unit/s ³)	LREAL	Positive number (The variable value must be set)	When <i>Execute</i> changes from FALSE to TRUE
BufferMode	Specify the behavior when executing two instructions. 0: Aborting 1: Buffered	MC_Buffer_Mode	0: mcAborting 1: mcBuffered (0)	When <i>Execute</i> changes from FALSE to TRUE

Note:

1. MC_Halt instruction is executed when *Execute* changes from FALSE to TRUE. There is no impact on the instruction execution when *Execute* of the instruction changes from TRUE to FALSE in the course of the instruction execution.
2. While *Execute* changes from FALSE to TRUE once more in the course of execution of MC_Halt, there is no impact on the instruction execution and the instruction will continue being executed in the previous way. When *Execute* changes from FALSE to TRUE once again after the instruction execution is completed, the instruction can be re-executed.
3. Refer to section10.2 for the relation between *Deceleration* and *Jerk*.
4. Refer to section10.3 for details on *BufferMode*.

● Output Parameters

Parameter name	Function	Data type	Valid range
Done	TRUE when the instruction execution is completed.	BOOL	TRUE/FALSE
Busy	TRUE when the instruction is being executed.	BOOL	TRUE/FALSE
Active	TRUE when the axis is being controlled.	BOOL	TRUE/FALSE
CommandAborted	TRUE when the instruction is aborted.	BOOL	TRUE/FALSE
Error	TRUE when there is an error.	BOOL	TRUE/FALSE
ErrorID	Contains error codes when an error occurs. Please refer to section 12.2 for the corresponding error code.	WORD	-

● Output Update Timing

Parameter Name	Timing for changing to TRUE	Timing for changing to FALSE
Done	<ul style="list-style-type: none"> ◆ When the deceleration ends and the axis speed is decreased to 0. 	<ul style="list-style-type: none"> ◆ When <i>Execute</i> changes from TRUE to FALSE after the instruction execution is completed. ◆ <i>Done</i> changes to TRUE when the instruction execution is completed after <i>Execute</i> changes from TRUE to FALSE during the instruction execution. One period later, <i>Done</i> changes to FALSE.
Busy	<ul style="list-style-type: none"> ◆ When <i>Execute</i> changes to TRUE. 	<ul style="list-style-type: none"> ◆ When <i>Done</i> changes to TRUE. ◆ When <i>Error</i> changes to TRUE. ◆ When <i>CommandAborted</i> changes to TRUE.
Active	<ul style="list-style-type: none"> ◆ When the instruction starts to control the axis. 	<ul style="list-style-type: none"> ◆ When <i>Done</i> changes to TRUE. ◆ When <i>Error</i> changes to TRUE. ◆ When <i>CommandAborted</i> changes to TRUE.
Command Aborted	<ul style="list-style-type: none"> ◆ When the instruction execution is aborted by other motion instruction. 	<ul style="list-style-type: none"> ◆ When <i>Execute</i> changes from TRUE to FALSE. ◆ <i>CommandAborted</i> changes to TRUE when the instruction is aborted after <i>Execute</i> changes from TRUE to FALSE during the instruction execution. One period later, <i>CommandAborted</i> changes to FALSE.
Error	<ul style="list-style-type: none"> ◆ When an error occurs in the instruction execution or the input parameters for the instruction are illegal. 	<ul style="list-style-type: none"> ◆ When <i>Execute</i> changes from TRUE to FALSE.

● **Output Update Timing Chart**

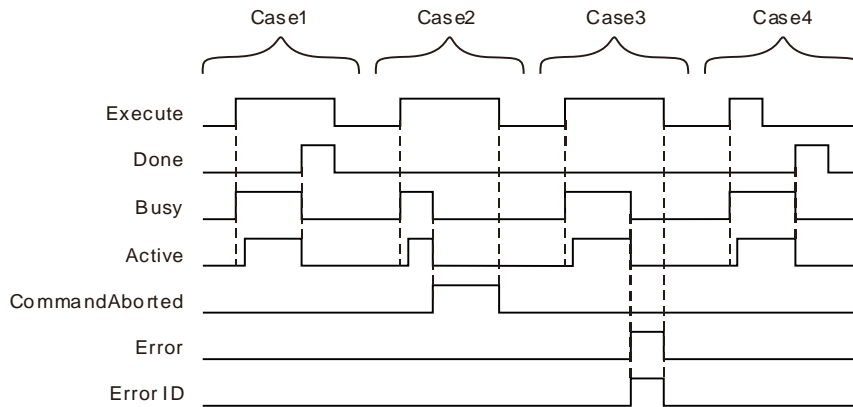

- Case 1 :** When *Execute* changes from FALSE to TRUE, *Busy* changes to TRUE and one period later, *Active* changes to TRUE. When the deceleration ends and the axis speed is decreased to 0, *Done* changes to TRUE and meanwhile *Busy* and *Active* change to FALSE.
- Case 2 :** After *Execute* changes from FALSE to TRUE and the instruction is aborted by other instruction, *CommandAborted* changes to TRUE and meanwhile *Busy* and *Active* change to FALSE. When *Execute* changes from TRUE to FALSE, *CommandAborted* changes to FALSE.
- Case 3 :** When an error occurs such as axis alarms or Offline after *Execute* changes from FALSE to TRUE, *Error* changes to TRUE and *ErrorID* shows the corresponding error code. Meanwhile, *Busy* and *Active* change to FALSE. *Error* changes to FALSE when *Execute* changes from TRUE to FALSE.
- Case 4 :** In the course of execution of the instruction, *Done* changes to TRUE when the instruction execution is completed after *Execute* changes from TRUE to FALSE. Meanwhile, *Busy* and *Active* change to FALSE and one period later, *Done* changes to FALSE.

● **Function**

MC_Halt is used to make the axis decelerate at a given deceleration rate till it stops.

- The state machine enters DiscreteMotion as MC_Halt starts being executed. When the axis speed is decreased to 0, *Done* changes to TRUE and meanwhile, the state machine enters Standstill.
- Compared to MC_Stop instruction, MC_Halt instruction can not make the axis locked and thus the controller can perform other motion instruction on it.

MC_Halt can be aborted through performing other motion instruction when the axis is decelerated during execution of MC_Halt. Other motion instruction can be executed by the controller to restart the axis after MC_Halt execution is over and the axis has stopped.



Programming Example

The example of MC_Halt execution is shown below.

1. The variable table and program

Variable name	Data type	Initial value
Pwr	MC_Power	
Axis1	USINT	1
Pwr_En	BOOL	FALSE
Pwr_BM	MC_Buffer_Mode	0
Pwr_Sta	BOOL	
Pwr_Bsy	BOOL	
Pwr_Act	BOOL	

Variable name	Data type	Initial value
Pwr_Err	BOOL	
Pwr_ErrID	WORD	
Vel	MC_MoveVelocity	
Vel_Ex	BOOL	FALSE
Vel_Dir	MC_DIRECTION	1
Vel_BM	MC_Buffer_Mode	0
Vel_Invel	BOOL	
Vel_Bsy	BOOL	
Vel_Act	BOOL	
Vel_Abt	BOOL	
Vel_Err	BOOL	
Vel_ErrID	WORD	
Hlt	MC_Halt	
Hlt_Ex	BOOL	FALSE
Hlt_BM	MC_Buffer_Mode	0
Hlt_Done	BOOL	
Hlt_Bsy	BOOL	
Hlt_Act	BOOL	
Hlt_Abt	BOOL	
Hlt_Err	BOOL	
Hlt_ErrID	WORD	

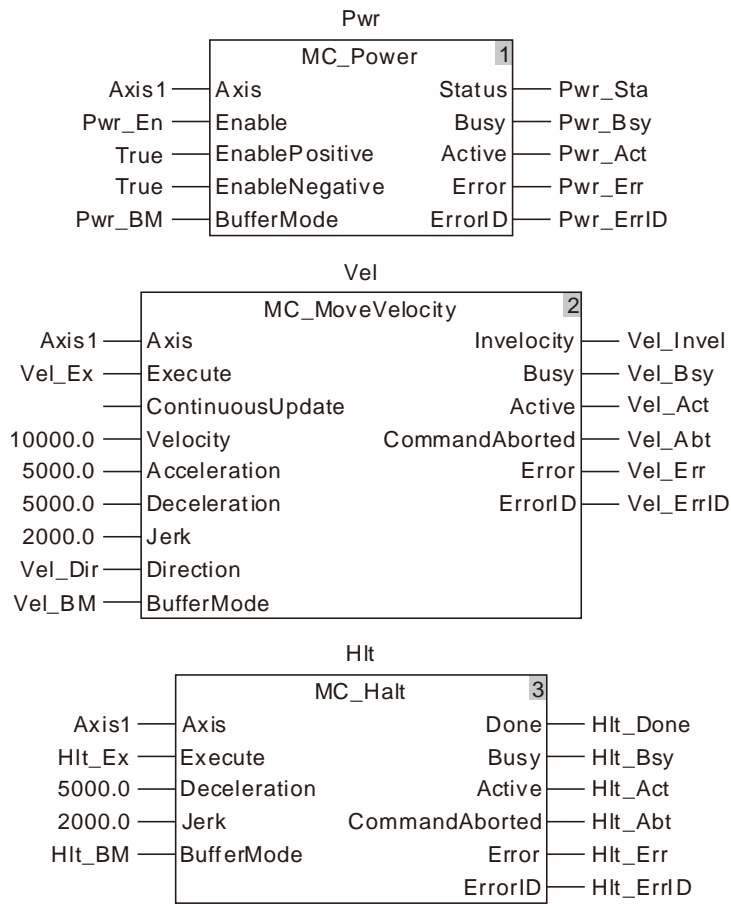

2. Motion Curve and Timing Charts:

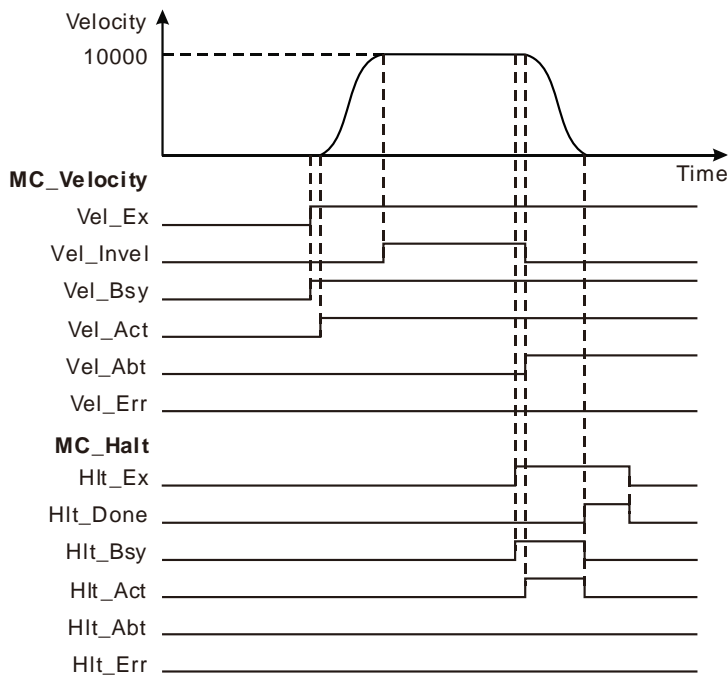

- ❖ When Vel_Ex changes to TRUE, Vel_Bsy changes to TRUE and one period later, Vel_Act changes to TRUE and the servo motor starts to move forward. Vel_Invel changes to TRUE as the servo motor reaches the target velocity.
- ❖ When Hlt_Ex changes to TRUE, Hlt_Bsy changes to TRUE and one period later, Hlt_Act changes to TRUE. Meanwhile, Vel_Invel changes to FALSE and Vel_Abt changes to TRUE and then the servo motor starts to decelerate.
- ❖ When the axis velocity is decreased to 0, Hlt_Done changes to TRUE and meanwhile, Hlt_Bsy and Hlt_Act change to FALSE.
- ❖ As Hlt_Ex changes to FALSE, Hlt_Done changes to FALSE.

11.3.5 MC_Stop

FB/FC	Explanation	Applicable model
FB	MC_Stop is used to make the axis decrease its speed at a given deceleration rate till it stops and then the axis goes into the Stopping state.	DVP15MC11T DVP15MC11T-06

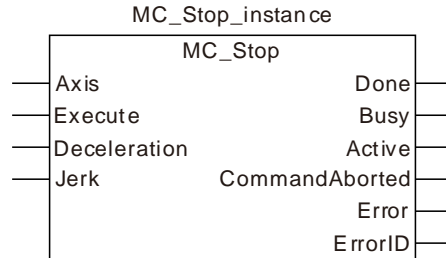

● Input Parameters

Parameter name	Function	Data type	Valid range (Default)	Validation timing
Axis	Specify the number of the axis which is to be controlled	USINT	Refer to Functions of Section 2.2. (The variable value must be set)	When <i>Execute</i> changes from FALSE to TRUE
Execute	The instruction is executed when <i>Execute</i> changes from FALSE to TRUE.	BOOL	TRUE or FALSE (FALSE)	
Deceleration	Specify the target deceleration rate. (Unit: Unit/s ²)	LREAL	Positive number (The variable value must be set)	When <i>Execute</i> changes from FALSE to TRUE
Jerk	Specify the change rate of the target acceleration or deceleration. (Unit: Unit/s ³)	LREAL	Positive number (The variable value must be set)	When <i>Execute</i> changes from FALSE to TRUE

Note:

1. MC_Stop instruction is executed when *Execute* changes from FALSE to TRUE. There is no impact on the instruction execution when *Execute* of the instruction changes from TRUE to FALSE in the course of the instruction execution.
2. While *Execute* changes from FALSE to TRUE once more in the course of execution of MC_Halt, there is no impact on the instruction execution and the instruction will continue being executed in the previous way. When *Execute* changes from FALSE to TRUE once again after the instruction execution is completed, the instruction can be re-executed.
3. Refer to section 10.2 for the relation between *Deceleration* and *Jerk*.

● Output Parameters

Parameter name	Function	Data type	Valid range
Done	TRUE when the instruction execution is completed.	BOOL	TRUE/FALSE
Busy	TRUE when the instruction is being executed.	BOOL	TRUE/FALSE
Active	TRUE when the axis is being controlled.	BOOL	TRUE/FALSE
CommandAborted	TRUE when the instruction is aborted.	BOOL	TRUE/FALSE
Error	TRUE when there is an error.	BOOL	TRUE/FALSE
ErrorID	Contains error codes when an error occurs. Please refer to section 12.2 for the corresponding error code.	WORD	

● Output Update Timing

Parameter name	Timing for changing to TRUE	Timing for changing to FALSE
Done	<ul style="list-style-type: none"> ◆ When the deceleration ends and the axis speed is decreased to 0. 	<ul style="list-style-type: none"> ◆ When <i>Execute</i> changes from TRUE to FALSE after the instruction execution is completed. ◆ <i>Done</i> changes to TRUE when the instruction execution is completed after <i>Execute</i> changes from TRUE to FALSE during the instruction execution. One period later, <i>Done</i> changes to FALSE.
Busy	<ul style="list-style-type: none"> ◆ When <i>Execute</i> changes to TRUE. 	<ul style="list-style-type: none"> ◆ When <i>Error</i> changes to TRUE. ◆ When <i>CommandAborted</i> changes to TRUE. ◆ When <i>Done</i> changes from TRUE to FALSE.
Active	<ul style="list-style-type: none"> ◆ When the instruction starts to control the axis. 	<ul style="list-style-type: none"> ◆ When <i>Error</i> changes to TRUE. ◆ When <i>CommandAborted</i> changes to TRUE. ◆ When <i>Done</i> changes from TRUE to FALSE.
CommandAborted	<ul style="list-style-type: none"> ◆ When the instruction execution is aborted by another MC_Stop. 	<ul style="list-style-type: none"> ◆ When <i>Execute</i> changes from TRUE to FALSE. ◆ <i>CommandAborted</i> changes to TRUE when the instruction is aborted by another MC_Stop after <i>Execute</i> changes from TRUE to FALSE during the instruction execution. One period later, <i>CommandAborted</i> changes to FALSE.
Error	<ul style="list-style-type: none"> ◆ When an error occurs in the instruction execution or the input parameters for the instruction are illegal. 	<ul style="list-style-type: none"> ◆ When <i>Execute</i> changes from TRUE to FALSE

● Output Update Timing Chart

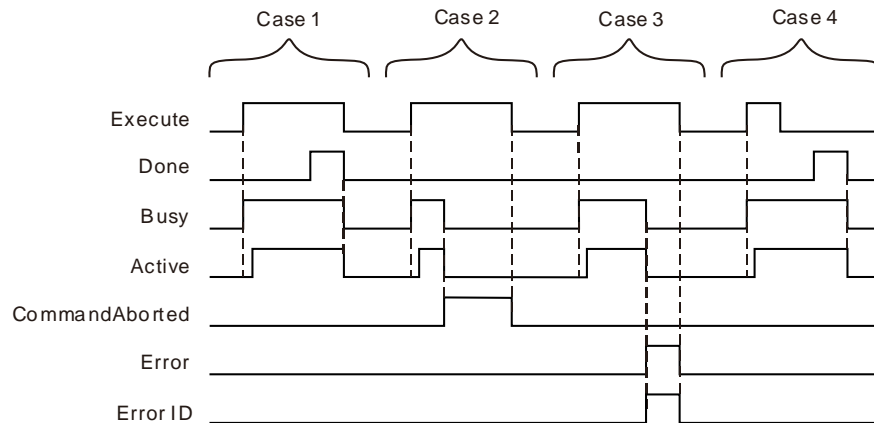

- Case 1 :** When *Execute* changes from FALSE to TRUE, *Busy* changes to TRUE and one period later, *Active* changes to TRUE. When the deceleration ends and the axis speed is decreased to 0, *Done* changes to TRUE and *Busy* and *Active* remain TRUE.
- Case 2 :** When the MC_Stop instruction is aborted by another MC_Stop instruction after *Execute* changes from FALSE to TRUE, *CommandAborted* changes to TRUE and meanwhile *Busy* and *Active* change to FALSE. When *Execute* changes from TRUE to FALSE, *CommandAborted* changes to FALSE.
- Case 3 :** When an error occurs such as axis alarm or Offline after *Execute* changes from FALSE to TRUE, *Error* changes to TRUE and *ErrorID* shows the corresponding error code. And Meanwhile, *Busy* and *Active* change to FALSE. *Error* changes to FALSE when *Execute* changes from TRUE to FALSE.
- Case 4 :** In the course of execution of the instruction, *Done* changes to TRUE and *Busy* and *Active* remain TRUE when the instruction execution is completed after *Execute* changes from TRUE to FALSE. One period later, *Done*, *Busy* and *Active* all change to FALSE.

● Function

MC_Stop is used to make the axis decrease its speed at a given deceleration rate till it stops.

- As long as *Execute* is TRUE after execution of MC_Stop is completed and the axis velocity is decreased to 0, the axis state will be in the Stopping state all the time. And during that period, other motion instruction can not be executed.
- If there are two MC_Stop instructions in the program for controlling the same axis, the previously being executed MC_Stop will be aborted by the later executed MC_Stop instruction.
- Compared to MC_Halt instruction, MC_Stop instruction will make the axis locked and thus the controller cannot perform other motion instruction excluding MC_Stop during MC_Stop execution. The controller still cannot perform other motion instructions when the execution of MC_Stop is finished and the axis has stopped. Other motion instruction can not be executed until *Execute* of MC_Stop changes from TRUE to FALSE.



Programming Example 1

The example of MC_Stop execution is shown as below.

1. The variable table and program

Variable name	Data type	Initial value
Pwr	MC_Power	
Axis1	USINT	1
Pwr_En	BOOL	FALSE
Pwr_BM	MC_Buffer_Mode	0
Pwr_Sta	BOOL	

Variable name	Data type	Initial value
Pwr_Bsy	BOOL	
Pwr_Act	BOOL	
Pwr_Err	BOOL	
Pwr_ErrID	WORD	
Vel	MC_MoveVelocity	
Vel_Ex	BOOL	FALSE
Vel_Dir	MC_DIRECTION	1
Vel_BM	MC_Buffer_Mode	0
Vel_Invel	BOOL	
Vel_Bsy	BOOL	
Vel_Act	BOOL	
Vel_Abt	BOOL	
Vel_Err	BOOL	
Vel_ErrID	WORD	
Stp	MC_Stop	
Stp_Ex	BOOL	FALSE
Stp_Done	BOOL	
Stp_Bsy	BOOL	
Stp_Act	BOOL	
Stp_Abt	BOOL	
Stp_Err	BOOL	
Stp_ErrID	WORD	

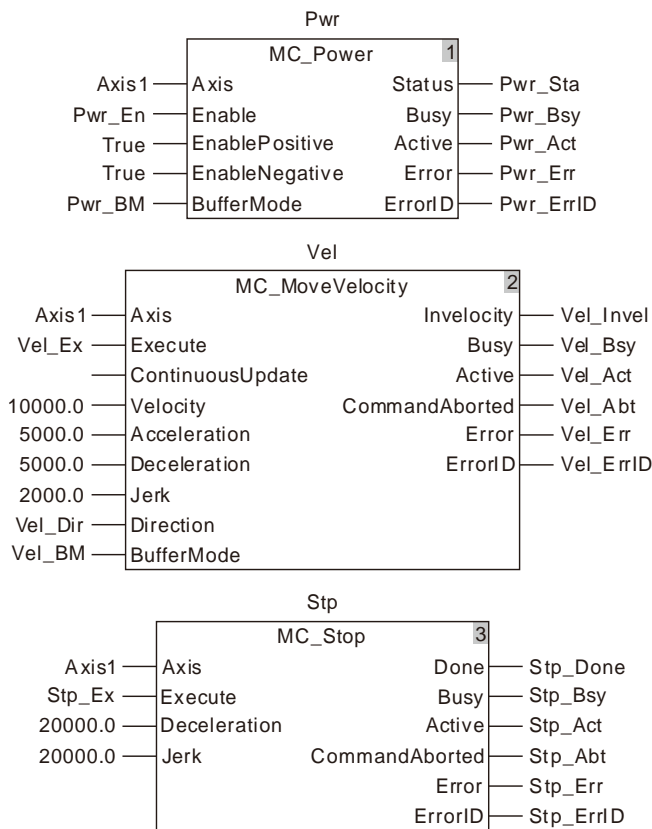

2. Motion Curve and Timing Charts:

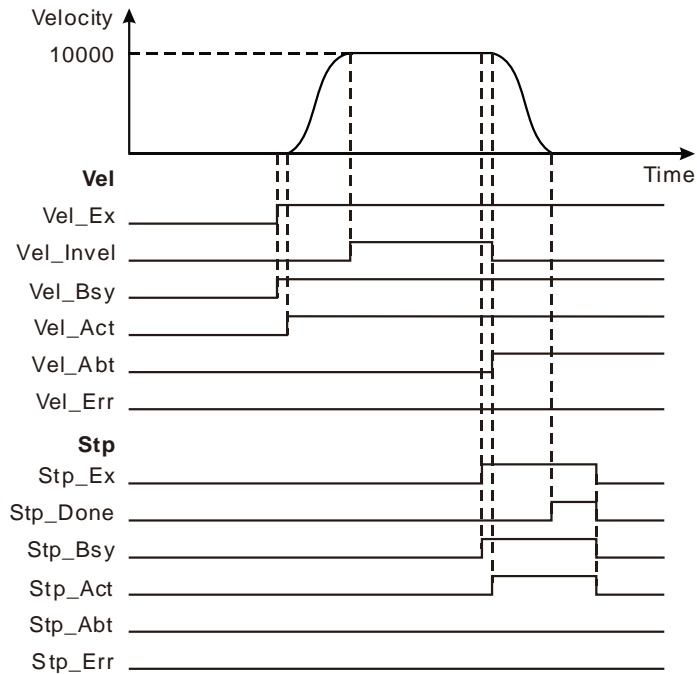

- ❖ As Vel_Ex changes to TRUE, Vel_Bsy changes to TRUE. One period later, Vel_Act changes to TRUE and the servo motor starts to move forward. Vel_Invel changes to TRUE when the servo motor reaches the target velocity.
- ❖ As Stp_Ex changes to TRUE, Stp_Bsy changes to TRUE. One period later, Stp_Act changes to TRUE, meanwhile Vel_Invel changes to FALSE, Vel_Abt changes to TRUE and the servo motor starts to decelerate.
- ❖ When the axis velocity is decreased to 0, Stp_Done changes to TRUE and meanwhile Stp_Bsy, Stp_Act remain TRUE.
- ❖ As Stp_Ex changes to FALSE, Stp_Done, Stp_Bsy and Stp_Act change to FALSE simultaneously.

11.3.6 MC_MoveRelative

FB/FC	Explanation	Applicable model
FB	MC_MoveRelative is used to make the axis move a given distance by starting from the command current position at a given speed, acceleration and deceleration and Jerk.	DVP15MC11T DVP15MC11T-06

11

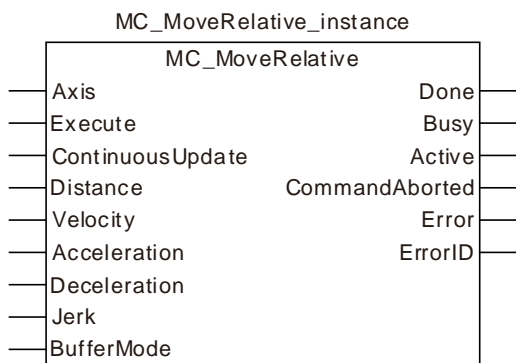

● Input Parameters

Parameter name	Function	Data type	Valid range (Default)	Validation timing
Axis	Specify the number of the axis which is to be controlled	USINT	Refer to Functions of Section 2.2. (The variable value must be set)	When <i>Execute</i> changes from FALSE to TRUE
Execute	The instruction is executed when <i>Execute</i> changes from FALSE to TRUE.	BOOL	TRUE or FALSE (FALSE)	-
ContinuousUpdate	Reserved	-	-	-
Distance	Specify the motion distance from command current position. (Unit: Unit)	LREAL	Negative number, positive number or 0 (0)	When <i>Execute</i> changes from FALSE to TRUE
Velocity	Specify the target velocity. (Unit: Unit/second)	LREAL	Positive number (The variable value must be set)	When <i>Execute</i> changes from FALSE to TRUE
Acceleration	Specify the target acceleration rate. (Unit: Unit/s ²)	LREAL	Positive number (The variable value must be set)	When <i>Execute</i> changes from FALSE to TRUE
Deceleration	Specify the target deceleration rate. (Unit: Unit/s ²)	LREAL	Positive number (The variable value must be set)	When <i>Execute</i> changes from FALSE to TRUE
Jerk	Specify the change rate of the target acceleration or deceleration. (Unit: Unit/s ³)	LREAL	Positive number (The variable value must be set)	When <i>Execute</i> changes from FALSE to TRUE
BufferMode	Specify the behavior when executing two instructions. 0: Aborting 1: Buffered 2: BlendingLow 3: BlendingPrevious 4: BlendingNext 5: BlendingHigh	MC_Buffer_Mode	0 : mcAborting 1 : mcBuffered 2 : mcBlendingLow 3 : mcBlendingsPrevious 4 : mcBlendingNext	When <i>Execute</i> changes from FALSE to TRUE

Parameter name	Function	Data type	Valid range (Default)	Validation timing
			5 : mcBlendingHigh (0)	

Notes:

1. MC_MoveRelative instruction is executed when *Execute* changes from FALSE to TRUE. There is no impact on the instruction execution when *Execute* of the instruction changes from TRUE to FALSE in the course of execution.
2. While the instruction is being executed and *Execute* changes from FALSE to TRUE again, there will be no impact on the instruction execution and the instruction will continue being executed in the previous way. When *Execute* changes from FALSE to TRUE again after the instruction execution is completed, the instruction can be re-executed and started in the conventional way.
3. Refer to section 10.2 for the relation among *Velocity*, *Acceleration* and *Jerk*.
4. Refer to section 10.3 for details on *BufferMode*.

- **Output Parameters**

Parameter name	Function	Data type	Valid range
Done	TRUE when the instruction execution is completed.	BOOL	TRUE / FALSE
Busy	TRUE when the instruction is being executed.	BOOL	TRUE / FALSE
Active	TRUE when the axis is being controlled by the instruction.	BOOL	TRUE / FALSE
CommandAborted	TRUE when the instruction execution is aborted.	BOOL	TRUE / FALSE
Error	TRUE while there is an error.	BOOL	TRUE / FALSE
ErrorID	Contains error codes when an error occurs. Please refer to the section 12.2 for corresponding error codes.	WORD	

- **Output Update Timing**

Parameter Name	Timing for changing to TRUE	Timing for changing to FALSE
Done	◆ When positioning is completed.	◆ When <i>Execute</i> changes from TRUE to FALSE after the instruction execution is completed. ◆ <i>Done</i> changes to TRUE when the instruction execution is completed after <i>Execute</i> changes from TRUE to FALSE during the instruction execution. One cycle later, <i>Done</i> changes to FALSE.
Busy	◆ When <i>Execute</i> changes to TRUE.	◆ When <i>Done</i> changes to TRUE. ◆ When <i>Error</i> changes to TRUE. ◆ When <i>CommandAborted</i> changes to TRUE.
Active	◆ When the instruction starts to control the axis.	◆ <i>Done</i> changes to TRUE. ◆ When <i>Error</i> changes to TRUE. ◆ When <i>CommandAborted</i> changes to TRUE.
CommandAborted	◆ When this instruction execution is aborted by other motion control instruction.	◆ When <i>Execute</i> changes from TRUE to FALSE. ◆ <i>CommandAborted</i> is set to TRUE when the instruction is aborted after <i>Execute</i>

Parameter Name	Timing for changing to TRUE	Timing for changing to FALSE
		changes from TRUE to FALSE during the instruction execution. One cycle later, <i>CommandAborted</i> changes to FALSE.
Error	◆ When an error occurs in the instruction execution or the input parameters for the instruction are illegal.	◆ When <i>Execute</i> changes from TRUE to FALSE.

● **Output Update Timing Chart**

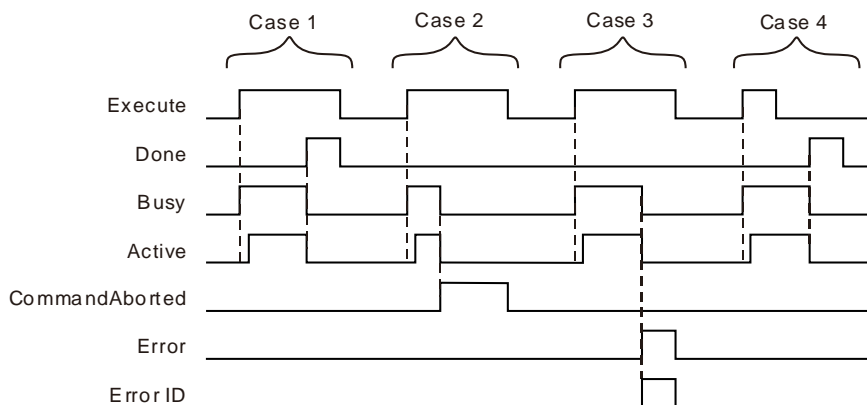

Case 1 : *Busy* changes to TRUE when *Execute* changes from FALSE to TRUE and one cycle later, *Active* changes to TRUE. When the positioning is finished, *Done* changes to TRUE and meanwhile, *Busy* and *Active* change to FALSE.

Case 2 : When *Execute* changes from FALSE to TRUE and the instruction is aborted by other instruction, *CommandAborted* changes to TRUE and meanwhile, *Busy* and *Active* change to FALSE. *CommandAborted* changes to FALSE when *Execute* changes from TRUE to FALSE.

Case 3 : When an error occurs such as axis alarm or Offline after *Execute* changes from FALSE to TRUE, *Error* changes to TRUE and *ErrorID* shows the corresponding error code. Meanwhile, *Busy* and *Active* change to FALSE. *Error* changes to FALSE when *Execute* changes from TRUE to FALSE.

Case 4 : In the course of execution of the instruction, *Done* changes to TRUE when the instruction execution is completed after *Execute* changes from TRUE to FALSE. Meanwhile, *Busy* and *Active* change to FALSE and one cycle later, *Done* changes to FALSE.

● **Function**

MC_MoveRelative is used to make the axis move for a given distance by starting from the command current axis position at a given speed, acceleration, deceleration and Jerk.

■ **Distance**

Distance and the start position for reference jointly determine the target position which the axis will reach under control of the instruction. The target position= the start position for reference + *Distance*. When *Distance* is set to 0, the target position for the axis motion is set as current position. The instruction execution is finished in the next cycle since its execution and *Done* changes to TRUE.

As illustrated in the following left figure, the start position for reference is 10000. The axis moves in the positive direction and the target position is 20000 (10000+10000) when *Distance*>0 (10000). In the following right figure, the axis moves in the negative direction and the target position is 0 (10000-10000) when *Distance*<0(-10000).

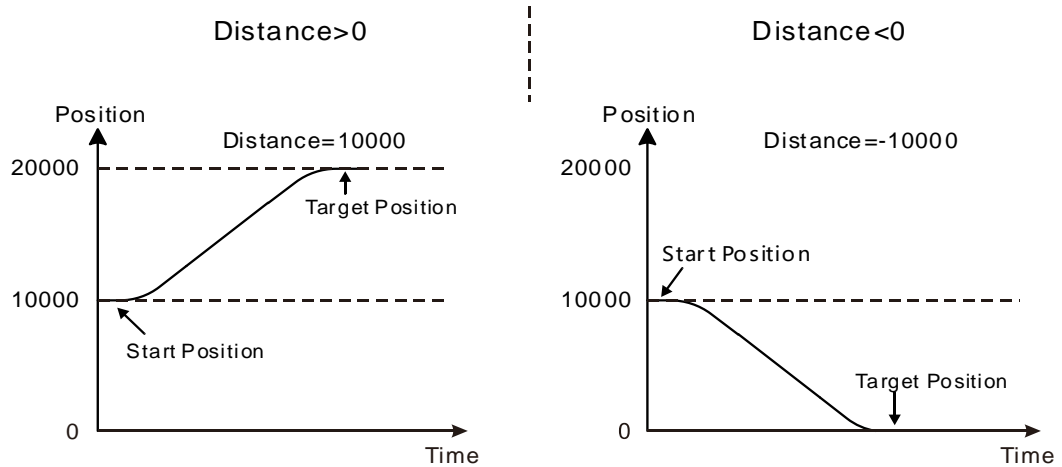

Programming Example 1

The programming example is as follows when one MC_MoveRelative instruction is used.

1. The variables and program

Variable name	Data type	Initial value
Pwr	MC_Power	
Axis1	USINT	1
Pwr_En	BOOL	FALSE
Pwr_BM	MC_Buffer_Mode	0
Pwr_Sta	BOOL	
Pwr_Bsy	BOOL	
Pwr_Act	BOOL	
Pwr_Err	BOOL	
Pwr_ErrID	WORD	
Rel	MC_MoveRelative	
Rel_Ex	BOOL	FALSE
Rel_BM	MC_Buffer_Mode	0
Rel_Done	BOOL	
Rel_Bsy	BOOL	
Rel_Act	BOOL	
Rel_Abt	BOOL	
Rel_Err	BOOL	
Rel_ErrID	WORD	

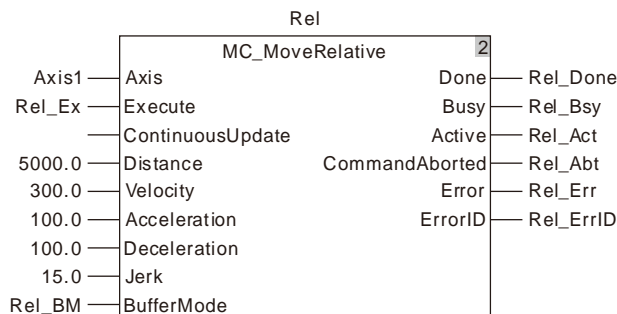
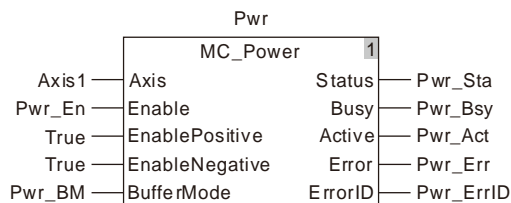

2. Motion Curve and Timing Chart

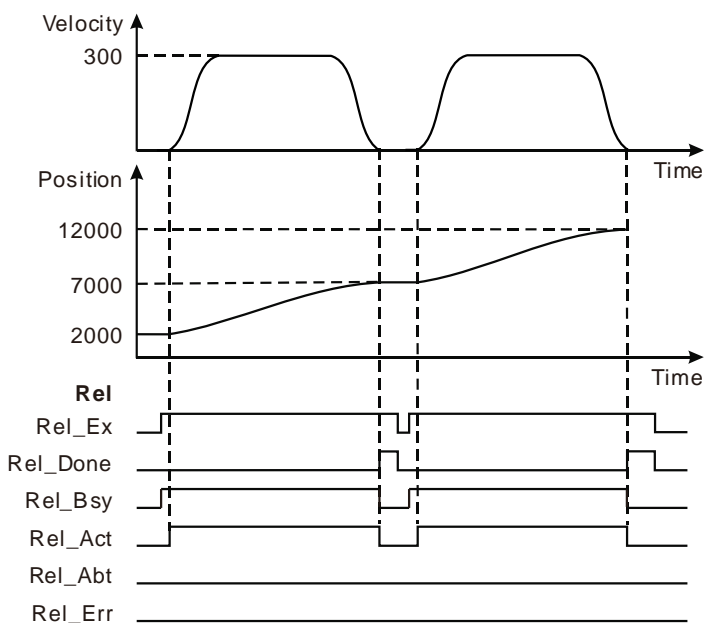

- ❖ MC_MoveRelative instruction is executed for the first time when Rel_Ex changes from FALSE to TRUE for the first time. At the moment, the current position of the axis is 2000 and the target position is 7000 (7000=2000+5000).
- ❖ When the axis position of 7000 is reached, the instruction execution is finished and Done changes to TRUE.
- ❖ MC_MoveRelative instruction starts its second-time execution when Rel_Ex changes from FALSE to TRUE for the second time. At the moment, the current position of the axis is 7000 and the target position is 12000 (12000=7000+5000).
- ❖ When the axis position of 12000 is reached, the second-time execution of the instruction is completed and Done changes to TRUE for the second time.



Programming Example 2

The example is shown below when MC_MoveRelative which is being executed is aborted.

1. The variables and program

Variable name	Data type	Initial value
Pwr	MC_Power	
Axis1	USINT	1
Pwr_En	BOOL	FALSE
Pwr_BM	MC_Buffer_Mode	0
Pwr_Sta	BOOL	
Pwr_Bsy	BOOL	
Pwr_Act	BOOL	
Pwr_Err	BOOL	
Pwr_ErrID	WORD	
Rel1	MC_MoveRelative	
Rel1_Ex	BOOL	FALSE
Rel1_BM	MC_Buffer_Mode	0
Rel1_Done	BOOL	
Rel1_Bsy	BOOL	
Rel1_Act	BOOL	
Rel1_Abt	BOOL	
Rel1_Err	BOOL	
Rel1_ErrID	WORD	
Rel2	MC_MoveRelative	
Rel2_Ex	BOOL	FALSE
Rel2_BM	MC_Buffer_Mode	0
Rel2_Done	BOOL	
Rel2_Bsy	BOOL	
Rel2_Act	BOOL	
Rel2_Abt	BOOL	
Rel2_Err	BOOL	
Rel2_ErrID	WORD	

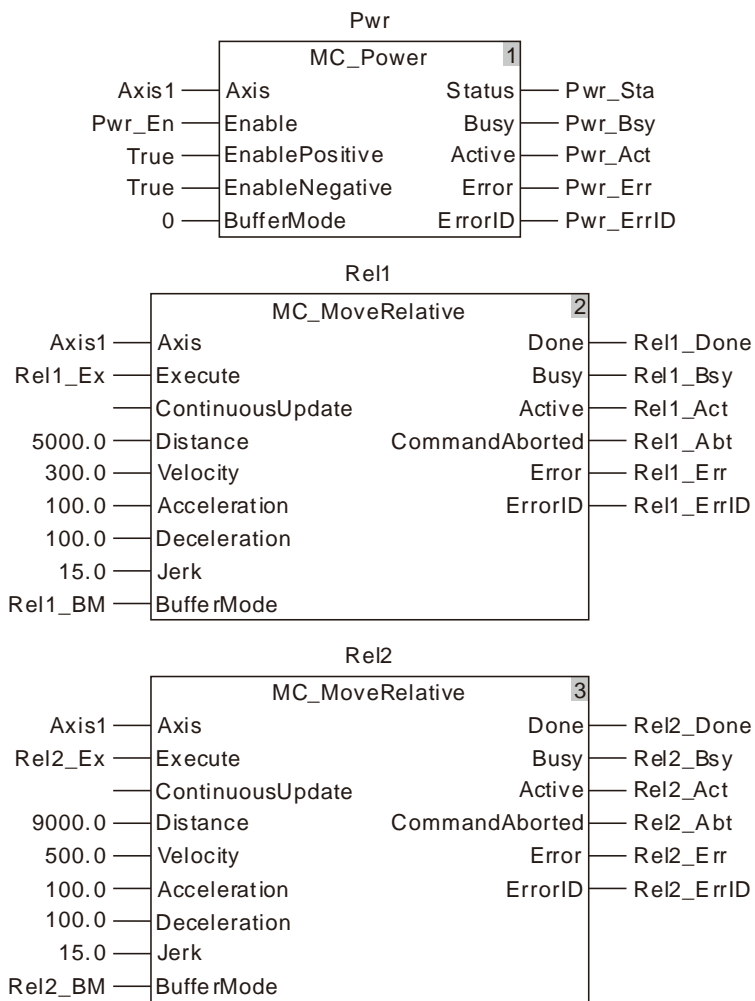

2. Motion Curve and Timing Chart

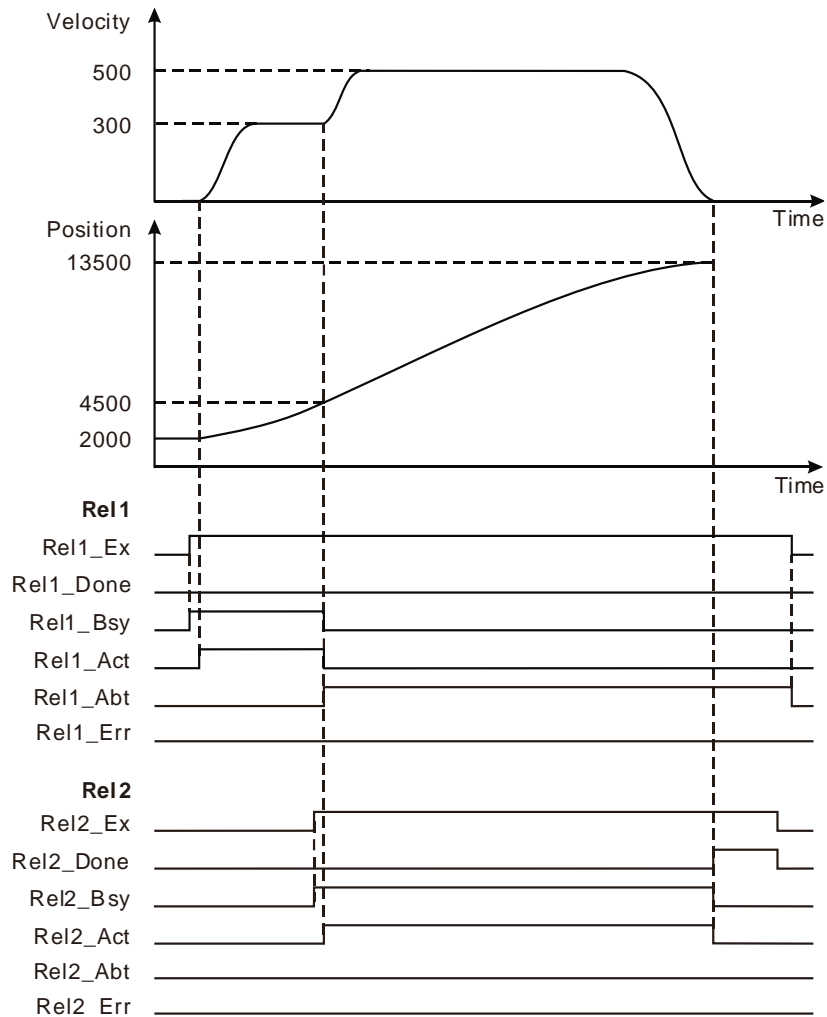

- ❖ The first MC_MoveRelative instruction starts being executed when Rel1_Ex changes from FALSE to TRUE. At the moment, the current position of the axis is 2000 and the target position is 7000 ($7000=2000+5000$).
- ❖ When the axis position of 4500 is reached, Rel2_Ex changes from FALSE to TRUE, the second MC_MoveRelative instruction starts being executed and the execution of the first MC_MoveRelative is aborted and Rel1_Abt changes to TRUE.
- ❖ When the axis position of 13500 ($13500=4500+9000$) is reached, the execution of the second MC_MoveRelative instruction is completed and Rel2_Done changes to TRUE.

11.3.7 MC_MoveAdditive

FB/FC	Explanation	Applicable model
FB	MC_MoveAdditive is used to make the axis move an additive distance at a given speed, acceleration and deceleration.	DVP15MC11T DVP15MC11T-06

11

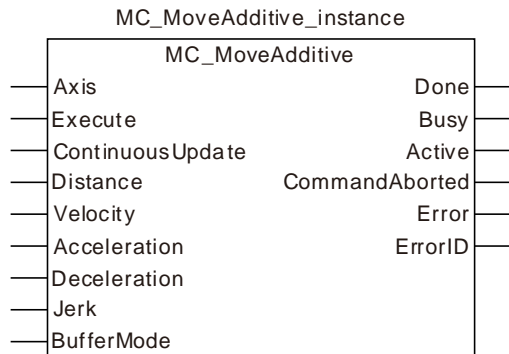

● Input Parameters

Parameter name	Function	Data type	Valid range (Default)	Validation timing
Axis	Specify the number of the axis which is to be controlled	USINT	Refer to Functions of Section 2.2. (The variable value must be set)	When <i>Execute</i> changes from FALSE to TRUE
Execute	The instruction is executed when <i>Execute</i> changes from FALSE to TRUE.	BOOL	TRUE or FALSE (FALSE)	-
ContinuousUpdate	Reserved	-	-	-
Distance	Specify the additive distance. (Unit: Unit)	LREAL	Negative number, positive number or 0 (0)	When <i>Execute</i> changes from FALSE to TRUE
Velocity	Specify the target velocity. (Unit: Unit/s)	LREAL	Positive number or 0 (0)	When <i>Execute</i> changes from FALSE to TRUE
Acceleration	Specify the target acceleration. (Unit: Unit/s ²)	LREAL	Positive number (The variable value must be set)	When <i>Execute</i> changes from FALSE to TRUE
Deceleration	Specify the target deceleration. (Unit: Unit/s ²)	LREAL	Positive number (The variable value must be set)	When <i>Execute</i> changes from FALSE to TRUE
Jerk	Specify the change rate of target acceleration and deceleration. (Unit: Unit/s ³)	LREAL	Positive number (The variable value must be set)	When <i>Execute</i> changes from FALSE to TRUE
BufferMode	Specify the behavior when executing two instructions. 0: Aborting 1: Buffered 2: BlendingLow 3: Blending Previous 4: BlendingNext 5: Blending High	MC_Buffer_Mode	0 : mcAborting 1 : mcBuffered 2 : mcBlendingLow 3 : mcBlendingPrevious 4 : mcBlendingNext 5 : mcBlendingHigh (0)	When <i>Execute</i> changes from FALSE to TRUE

Notes:

1. MC_MoveAdditive instruction is executed when *Execute* changes from FALSE to TRUE. There is no impact on the instruction execution when *Execute* of the instruction in the course of execution changes from TRUE to FALSE.
2. When *Execute* of the being executed instruction changes from FALSE to TRUE again, there is no impact on the instruction execution and the instruction will go on being executed in the previous way. When *Execute* changes from FALSE to TRUE again after the instruction execution is completed, the instruction can be re-executed and started in the conventional way.
3. Refer to section 10.2 for the relation among *Position*, *Velocity*, *Acceleration* and *Jerk*.
4. Refer to section 10.3 for details on *BufferMode*.

● Output Parameters

Parameter name	Function	Data type	Valid range
Done	TRUE when the instruction is completed.	BOOL	TRUE / FALSE
Busy	TRUE when the instruction is being executed.	BOOL	TRUE / FALSE
Active	TRUE when the axis is being controlled.	BOOL	TRUE / FALSE
CommandAborted	TRUE when the instruction is aborted.	BOOL	TRUE / FALSE
Error	TRUE while there is an error.	BOOL	TRUE / FALSE
ErrorID	Contains the error code when an error occurs. Please refer to the section 12.2.	WORD	

● Output Update Timing

Parameter Name	Timing for changing to TRUE	Timing for changing to FALSE
Done	◆ When additive positioning is completed.	◆ When <i>Execute</i> changes from TRUE to FALSE after the instruction execution is done. ◆ <i>Done</i> changes to TRUE when the instruction execution is completed after <i>Execute</i> changes from TRUE to FALSE during the instruction execution. One period later, <i>Done</i> changes to FALSE.
Busy	◆ When <i>Execute</i> changes to TRUE.	◆ When <i>Done</i> changes to TRUE. ◆ When <i>Error</i> changes to TRUE. ◆ When <i>CommandAborted</i> changes to TRUE.
Active	◆ When the instruction starts controlling the axis.	◆ When <i>Done</i> changes to TRUE. ◆ When <i>Error</i> changes to TRUE. ◆ When <i>CommandAborted</i> changes to TRUE.
CommandAborted	◆ When the instruction execution is aborted by some other motion control instruction	◆ When <i>Execute</i> changes from TRUE to FALSE. ◆ <i>CommandAborted</i> is set to TRUE when the instruction execution is aborted after <i>Execute</i> changes from TRUE to FALSE during the instruction execution. One period later, <i>CommandAborted</i> changes to FALSE.
Error	◆ When an error occurs in the instruction execution or the input parameters for the instruction are illegal.	◆ When <i>Execute</i> changes from TRUE to FALSE.

● Output Update Timing Chart

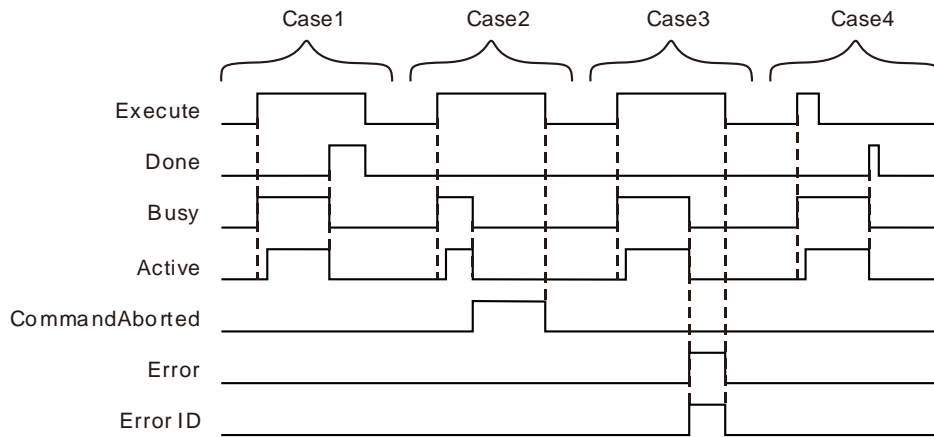

- Case 1 :** When *Execute* changes from FALSE to TRUE, *Busy* changes to TRUE and one period later, *Active* changes to TRUE. When positioning is finished, *Done* changes to TRUE and meanwhile, *Busy* and *Active* change to FALSE.
- Case 2 :** When *Execute* changes from FALSE to TRUE and the instruction execution is aborted by some other instruction, *CommandAborted* changes to TRUE and meanwhile, *Busy* and *Active* change to FALSE. When *Execute* changes from TRUE to FALSE, *CommandAborted* changes to FALSE.
- Case 3 :** When *Execute* changes from FALSE to TRUE and an error occurs such as axis alarm or Offline, *Error* changes to TRUE and *ErrorID* shows corresponding error codes. Meanwhile, *Busy* and *Active* change to FALSE. *Error* changes to FALSE when *Execute* changes from TRUE to FALSE.
- Case 4 :** In the course of execution of the instruction, *Done* changes to TRUE when the instruction execution is completed after *Execute* changes from TRUE to FALSE. Meanwhile, *Busy* and *Active* change to FALSE and one period later, *Done* changes to FALSE.

● Function

MC_MoveAdditive can control the actuator to move an additive distance at a given speed and acceleration.

The execution of the former instruction related with positioning has not been finished yet and the distance which the terminal actuator will move includes the uncompleted distance left by the former instruction and the given distance of this instruction when MC_MoveAdditive is executed. When the execution of MC_MoveAdditive is completed, the final position of the terminal actuator is the sum of the given distances of the former instruction and current instruction MC_MoveAdditive.

If the former instruction is a velocity instruction, MC_MoveAdditive will abort the execution of the velocity instruction and the terminal actuator will stop after moving a given distance of MC_MoveAdditive at a given speed, acceleration and deceleration.

If MC_MoveAdditive is executed while MC_MoveSuperimposed is individually executed, the instruction will abort MC_MoveSuperimposed immediately when the value of *BufferMode* of MC_MoveAdditive is 0. The distance which the terminal actuator will move includes the set distance of this instruction and the uncompleted distance left by MC_MoveSuperimposed while MC_MoveAdditive is executed.

An error will occur in the instruction right away if the value of *BufferMode* is in the range of 1~5 and the execution of MC_MoveSuperimposed instruction will continue.

If MC_MoveAdditive is executed when MC_MoveSuperimposed is used with a positioning instruction together, the instruction will abort MC_MoveSuperimposed and the positioning instruction when the value of *BufferMode* of MC_MoveAdditive is 0. The distance which the terminal actuator will move is the sum of the given distance of MC_MoveAdditive and the uncompleted distance left by the position instruction which is used with MC_MoveSuperimposed together, excluding the uncompleted distance

left by MC_MoveSuperimposed while MC_MoveAdditive is executed. MC_MoveAdditive instruction will be executed after the execution of the positioning instruction which is used in conjunction with MC_MoveSuperimposed is completed if the value of *BufferMode* of MC_MoveAdditive is 1~5.

- **MC_MoveAdditive is started while MC_MoveSuperimposed is being executed.**

BufferMode of MC_MoveAdditive	Whether MC_MoveSuperimposed is being executed in conjunction with other position instruction	Description
0 (Abort)	Yes	<ul style="list-style-type: none"> ◆ The execution of MC_MoveSuperimposed and other position instruction will be aborted immediately. ◆ When MC_MoveAdditive is executed, the distance that the terminal actuator will travel is the set distance of MC_MoveAdditive plus the uncompleted distance left by MC_MoveSuperimposed plus the uncompleted distance left by the position instruction in conjunction with MC_MoveSuperimposed.
	No	<ul style="list-style-type: none"> ◆ MC_MoveSuperimposed is aborted immediately. ◆ When MC_MoveAdditive is executed, the terminal actuator will travel the distance which is the sum of the uncompleted distance left by MC_MoveSuperimposed and the set distance of MC_MoveAdditive.
1~5 (Buffered)	Yes	<ul style="list-style-type: none"> ◆ MC_MoveSuperimposed will not be affected and keep being executed. ◆ After the execution of the position instruction in conjunction with MC_MoveSuperimposed ends, MC_MoveAdditive will start.
	No	<ul style="list-style-type: none"> ◆ The execution of MC_MoveSuperimposed will continue. ◆ MC_MoveAdditive will report an error immediately.



Programming Example 1

Below is an example of one single MC_MoveAbsolute instruction execution.

1. The variables and program

Variable name	Data type	Initial value
Pwr	MC_Power	
Axis1	USINT	1
Pwr_En	BOOL	FALSE
Pwr_BM	MC_Buffer_Mode	0
Pwr_Sta	BOOL	
Pwr_Bsy	BOOL	
Pwr_Act	BOOL	

Variable name	Data type	Initial value
Pwr_Err	BOOL	
Pwr_ErrID	WORD	
Addt	MC_MoveAdditive	
Addt_Ex	BOOL	FALSE
Addt_BM	MC_Buffer_Mode	0
Addt_Done	BOOL	
Addt_Bsy	BOOL	
Addt_Act	BOOL	
Addt_Abt	BOOL	
Addt_Err	BOOL	
Addt_ErrID	WORD	

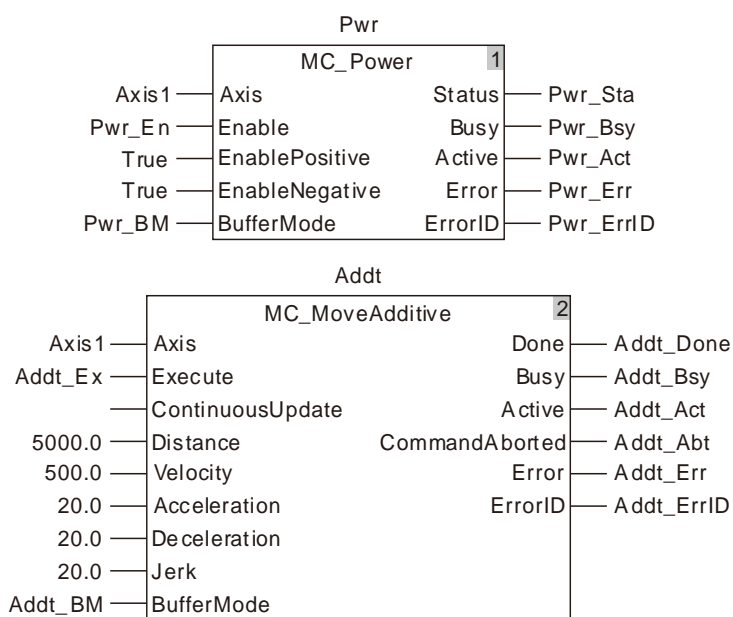

2. Motion Curve and Timing Charts:

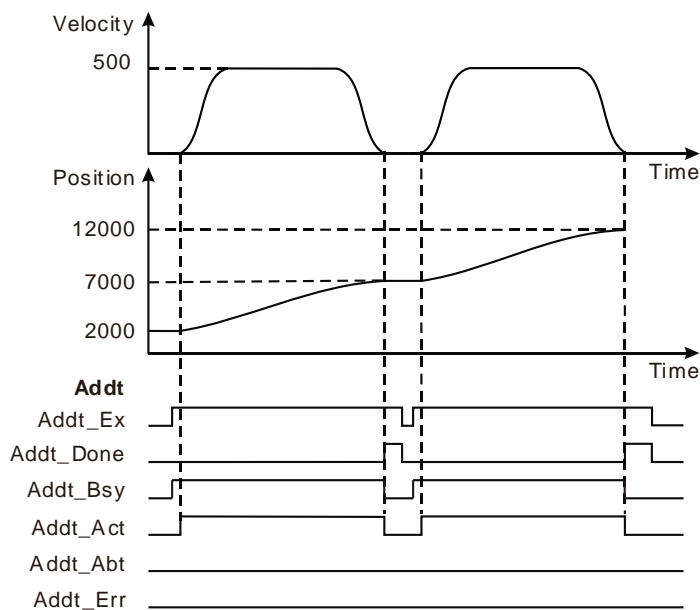

- ❖ When Addt_Ex changes from FALSE to TRUE, the motion controller controls the motion of the servo motor by taking current position as the reference point. Meanwhile, Addt_Bsy changes to TRUE and one period later, Addt_Act changes to TRUE. After the set distance is reached by the servo motor, Addt_Done changes from FALSE to TRUE and meanwhile Addt_Bsy and Addt_Act change from TRUE to FALSE.
- ❖ When Addt_Ex changes from TRUE to FALSE, Addt_Done is reset.
- ❖ When Addt_Ex changes from FALSE to TRUE again after the servo motor reaches the set distance, the motion controller controls the motion of the servo motor and Addt_Done changes from FALSE to TRUE once again after the servo motor reaches the set distance.



Programming Example 2

Below is an example on the execution of two MC_MoveAdditive instructions in the same task list.

1. The variables and program

Variable name	Data type	Initial value
Pwr	MC_Power	
Axis1	USINT	1
Pwr_En	BOOL	FALSE
Pwr_BM	MC_Buffer_Mode	0
Pwr_Sta	BOOL	
Pwr_Bsy	BOOL	
Pwr_Act	BOOL	
Pwr_Err	BOOL	
Pwr_ErrID	WORD	
Addt1	MC_MoveAdditive	
Addt1_Ex	BOOL	FALSE
Addt1_BM	MC_Buffer_Mode	0
Addt1_Done	BOOL	
Addt1_Bsy	BOOL	
Addt1_Act	BOOL	
Addt1_Abt	BOOL	
Addt1_Err	BOOL	
Addt1_ErrID	WORD	
Addt2	MC_MoveAdditive	
Addt2_Ex	BOOL	FALSE
Addt2_BM	MC_Buffer_Mode	0
Addt2_Done	BOOL	
Addt2_Bsy	BOOL	
Addt2_Act	BOOL	
Addt2_Abt	BOOL	
Addt2_Err	BOOL	
Addt2_ErrID	WORD	

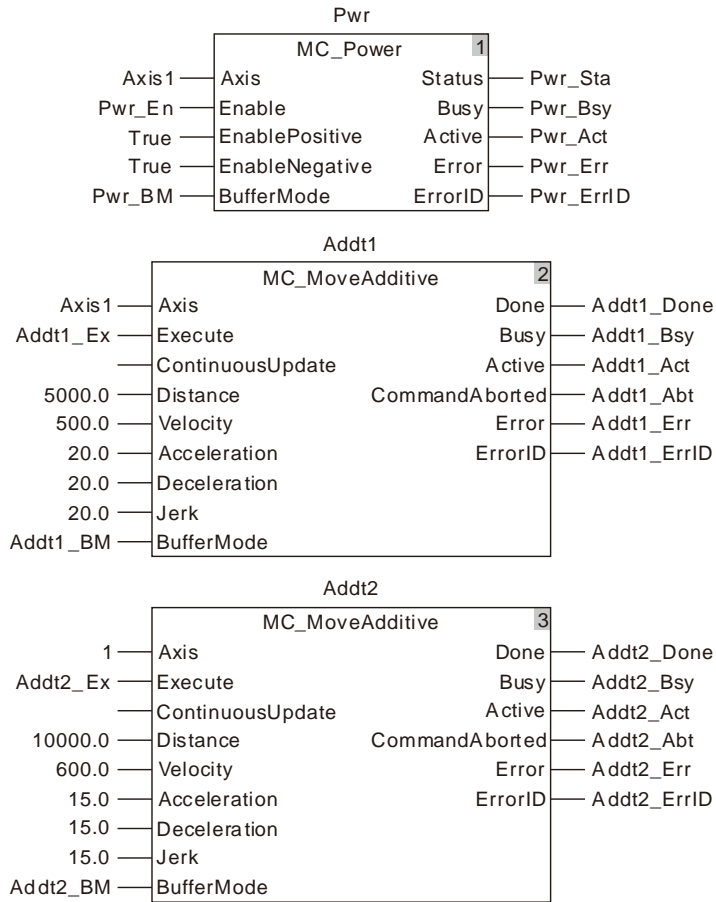

2. Motion Curve and Timing Charts:

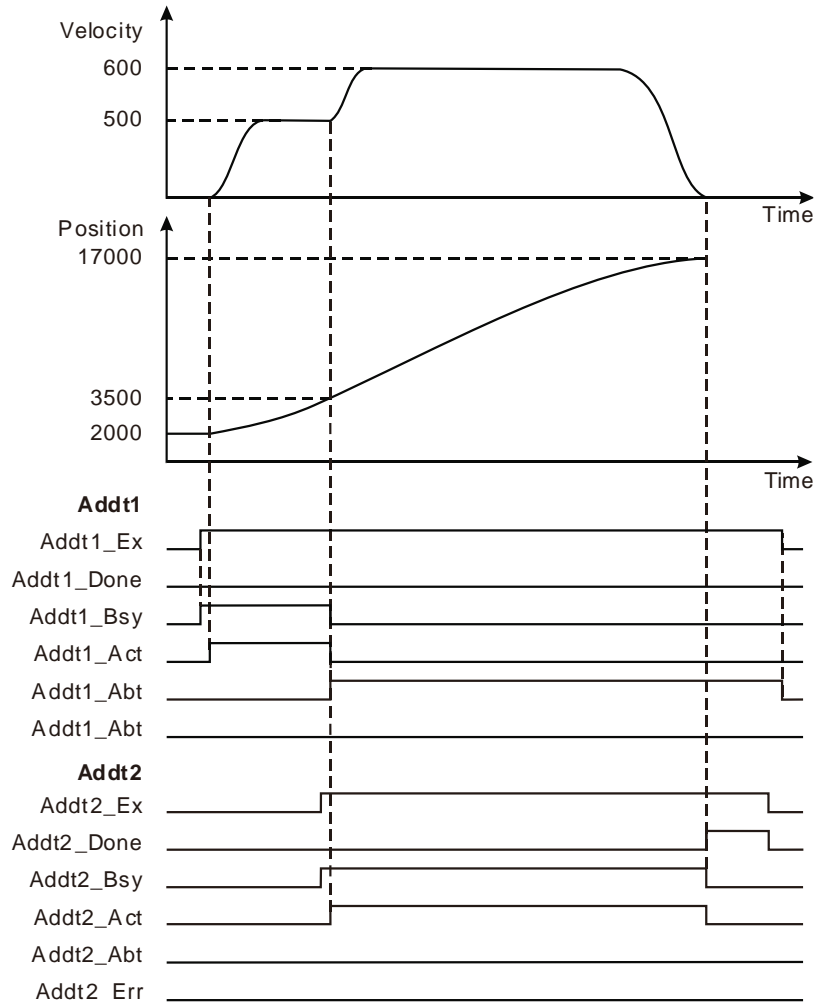

- ❖ When `Addt1_Ex` changes from FALSE to TRUE, the motion controller controls the motion of the servo motor taking current position as the reference point. When `Addt2_Ex` changes from FALSE to TRUE, `Addt2_Bsy` changes from FALSE to TRUE and one period later, the first `MC_MoveAdditive` instruction is aborted and `Addt1_Abt` changes from FALSE to TRUE. Meanwhile, the servo motor moves according to the parameters of the second `MC_MoveAdditive` instruction. `Addt2_Done` changes from FALSE to TRUE when the servo motor completes the set distance which is the total sum of the two set distances of the two instructions.
- ❖ When `Addt2_Ex` changes from TRUE to FALSE, `Addt2_Done` is reset.

11.3.8 MC_MoveAbsolute

FB/FC	Explanation	FB/FC
FB	MC_MoveAbsolute is used to make the axis move to the specified absolute target position at the given speed, acceleration and deceleration.	DVP15MC11T DVP15MC11T-06

11

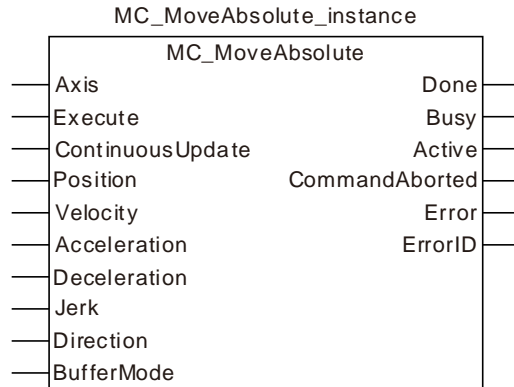

● Input Parameters

Parameter name	Function	Data type	Valid range (Default)	Validation timing
Axis	Specify the number of the axis which is to be controlled	USINT	Refer to Functions of Section 2.2. (The variable value must be set)	When <i>Execute</i> changes from FALSE to TRUE
Execute	The instruction is executed when <i>Execute</i> changes from FALSE to TRUE.	BOOL	TRUE or FALSE (FALSE)	-
ContinuousUpdate	Reserved	-	-	-
Position	Specify the absolute target position. Rotary axis: $0 \leq \text{Position} < \text{Modulo}$ Linear axis: No limit to Position. (Unit: Unit)	LREAL	Negative number, positive number or 0 (0)	When <i>Execute</i> changes from FALSE to TRUE
Velocity	Specify the target velocity. (Unit: Unit/s)	LREAL	Positive number (The variable value must be set)	When <i>Execute</i> changes from FALSE to TRUE
Acceleration	Specify the target acceleration. (Unit: Unit/s ²)	LREAL	Positive number (The variable value must be set)	When <i>Execute</i> changes from FALSE to TRUE
Deceleration	Specify the target deceleration. (Unit: Unit/s ²)	LREAL	Positive number (The variable value must be set)	When <i>Execute</i> changes from FALSE to TRUE
Jerk	Specify the change rate of target acceleration or deceleration. (Unit: Unit/s ³)	LREAL	Positive number (The variable value must be set)	When <i>Execute</i> changes from FALSE to TRUE
Direction	Specify the rotation direction (which is valid only when the axis is the rotary axis).	MC_Direction	1: mcPositiveDirection, 2: mcShortestWay, 3: mcNegativeDirection , 4: mcCurrentDirection	When <i>Execute</i> changes from FALSE to TRUE and the

Parameter name	Function	Data type	Valid range (Default)	Validation timing
	1: Positive direction 2: Shortest way 3: Negative direction 4: Current direction		(1)	axis is in the mode of rotary axis
BufferMode	Specify the behavior when executing two instructions. 0 : McAborting 1 : McBuffered 2 : McBlendingLow 3 : McBlendingPrevious 4 : McBlendingNext 5 : McBlendingHigh	MC_Buffer_Mode	0 : mcAborting 1 : mcBuffered 2 : mcBlendingLow 3 : mcBlendingPrevious 4 : mcBlendingNext 5 : mcBlendingHigh (0)	When Execute changes from FALSE to TRUE

Notes:

1. MC_MoveAbsolute instruction is executed when *Execute* changes from FALSE to TRUE. There is no impact on the instruction execution when *Execute* of the instruction in the course of execution changes from TRUE to FALSE.
2. When *Execute* of the being executed instruction changes from FALSE to TRUE again, there is no impact on the instruction execution and the instruction will go on being executed in the previous way. When *Execute* changes from FALSE to TRUE again after the instruction execution is completed, the instruction can be re-executed.
3. When the axis is a rotary axis, Position can be the value within the range of 0~the value of modulo excluding the value of modulo. An error will occur in the instruction if the absolute value of Position is greater than or equal to the value of modulo. The value of Position is irrelevant to the value of modulo and it can be set to any constant if the axis is a linear axis.
4. *Direction* is valid only when the axis is the rotary axis. Refer to *Direction* in the following Function section for more details on *Direction*.
5. Refer to section 10.2 for the relation among *Position*, *Velocity*, *Acceleration* and *Jerk*.
6. Refer to section 10.3 for details on *BufferMode*.

● **Output Parameters**

Parameter name	Function	Data type	Valid range
Done	TRUE when the instruction execution is completed.	BOOL	TRUE / FALSE
Busy	TRUE when the instruction is being executed.	BOOL	TRUE / FALSE
Active	TRUE when the axis is being controlled by the instruction.	BOOL	TRUE / FALSE
CommandAborted	TRUE when the instruction execution is aborted.	BOOL	TRUE / FALSE
Error	TRUE while there is an error in the execution of the instruction.	BOOL	TRUE / FALSE
ErrorID	Contains the error code when an error occurs. Please refer to section 12.2 for corresponding error codes.	WORD	

● Output Update Timing

Parameter Name	Timing for changing to TRUE	Timing for changing to FALSE
Done	◆ When absolute positioning is completed	◆ When <i>Execute</i> changes from TRUE to FALSE after the instruction execution is done. ◆ <i>Done</i> changes to TRUE when the instruction execution is completed after <i>Execute</i> changes from TRUE to FALSE during the instruction execution. One period later, <i>Done</i> changes to FALSE.
Busy	◆ When <i>Execute</i> changes to TRUE.	◆ When <i>Done</i> changes to TRUE. ◆ When <i>Error</i> changes to TRUE. ◆ When <i>CommandAborted</i> changes to TRUE.
Active	◆ When the instruction starts controlling the axis.	◆ When <i>Done</i> changes to TRUE. ◆ When <i>Error</i> changes to TRUE. ◆ When <i>CommandAborted</i> changes to TRUE.
CommandAborted	◆ When the instruction execution is aborted by some other motion control instruction.	◆ When <i>Execute</i> changes from TRUE to FALSE. ◆ <i>CommandAborted</i> is set to TRUE when the instruction execution is aborted after <i>Execute</i> changes from TRUE to FALSE during the instruction execution. One period later, <i>CommandAborted</i> changes to FALSE.
Error	◆ When an error occurs in the instruction execution or the input parameters for the instruction are illegal.	◆ When <i>Execute</i> changes from TRUE to FALSE

● Output Update Timing Chart

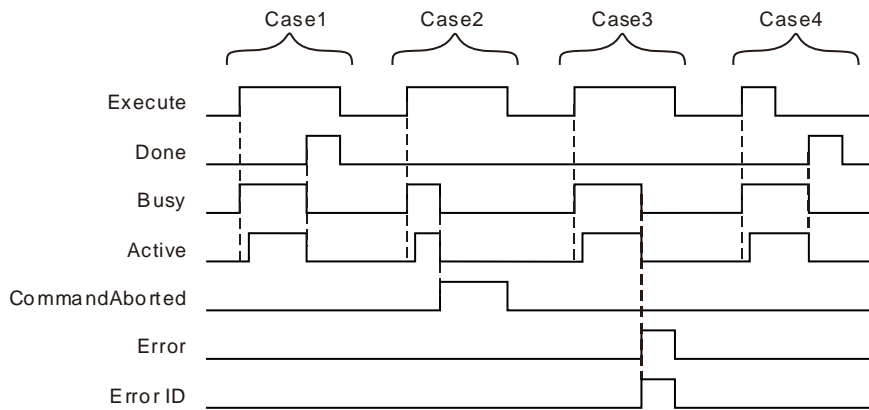

- Case 1 :** When *Execute* changes from FALSE to TRUE, *Busy* changes to TRUE and one period later, *Active* changes to TRUE. When positioning is completed, *Done* changes to TRUE and meanwhile, *Busy* and *Active* change to FALSE.
- Case 2 :** When the instruction execution is aborted by some other motion instruction after *Execute* changes from FALSE to TRUE, *Abort* changes to TRUE and meanwhile, *Busy* and *Active* change to FALSE. When *Execute* changes from TRUE to FALSE, *CommandAborted* changes to FALSE.
- Case 3 :** When *Execute* changes from FALSE to TRUE and an error occurs such as axis alarm or Offline, *Error* changes to TRUE and *ErrorID* shows the corresponding error code. And Meanwhile, *Busy* and *Active* change to FALSE. *Error* changes to FALSE when *Execute* changes from TRUE to FALSE.

Case 4 : In the course of execution of the instruction, *Done* changes to TRUE when the instruction execution is completed after *Execute* changes from TRUE to FALSE. Meanwhile, *Busy* and *Active* change to FALSE and one period later, *Done* changes to FALSE.

● **Function**

MC_MoveAbsolute is used to make the axis move to the specified absolute target position at the set speed, acceleration and deceleration.

The start axis position is 10000 when MC_MoveAbsolute instruction is executed. The axis will move reversely when *Position* > 0 (5000). See the figure below when *Position* is 5000.

The axis will move reversely when *Position* < 0 (-5000). See the figure below when *Position* is -5000.

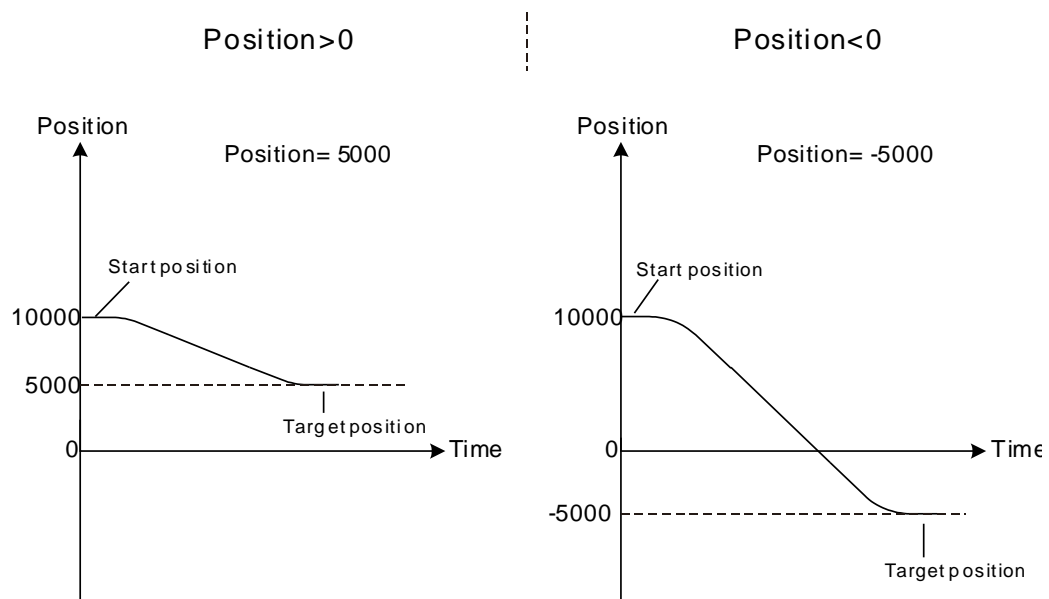

Note: As long as MC_MoveAbsolute instruction which is being executed is aborted, its uncompleted distance will be discarded and the new instruction will be executed.

■ **Direction**

Direction is valid when the axis is a rotary axis and different motion directions of the axis are listed in the following table based on different *Direction* value. (Modulo: 360)

11

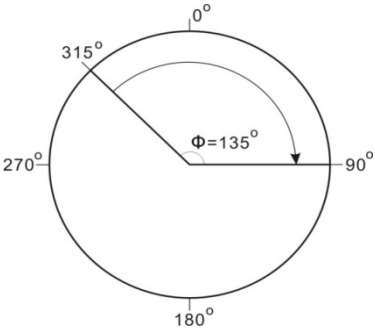
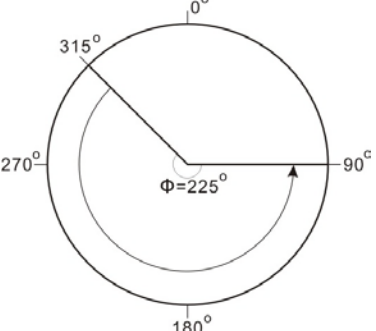
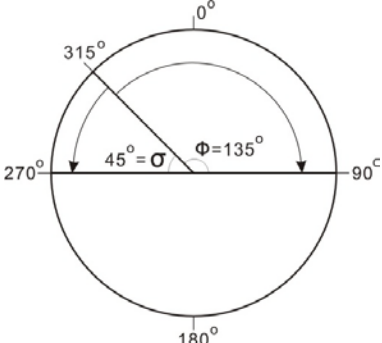
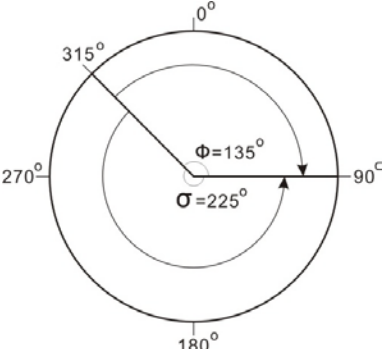
<p>Direction: 1 (Positive direction) Current position: 315° Target position: 90° Movement angle: 135°</p>	<p>Direction: 3 (Negative direction) Current position: 315° Target position: 90° Movement angle: 225°</p>
	
<p>Direction: 2 (Shortest way) Current position: 315° Target position: 90° Movement angle: 135°</p>	<p>Direction: 2 (Shortest way) Current position: 315° Target position: 270° Movement angle: 45°</p>
	
<p>Direction: 4 (Current direction) The status of the rotary axis before the instruction is executed: Moving in the negative direction. Current position: 315° Target position: 90° Movement angle: 225°</p>	<p>Direction: 4 (Current direction) The status of the rotary axis before the instruction is executed: motionless or moving in the positive direction. Current position: 315° Target position: 90° Movement angle: 135°</p>
	



Programming Example 1

One MC_MoveAbsolute is executed as follows.

1. The variables and program

Variable name	Data type	Initial value
Pwr	MC_Power	
Axis1	USINT	1
Pwr_En	BOOL	FALSE
Pwr_BM	MC_Buffer_Mode	0
Pwr_Sta	BOOL	
Pwr_Bsy	BOOL	
Pwr_Act	BOOL	
Pwr_Err	BOOL	
Pwr_ErrID	WORD	
Abs	MC_MoveAbsolute	
Abs_Ex	BOOL	FALSE
Abs_Dir	MC_DIRECTION	0
Abs_BM	MC_Buffer_Mode	0
Abs_Done	BOOL	
Abs_Bsy	BOOL	
Abs_Act	BOOL	
Abs_Abt	BOOL	
Abs_Err	BOOL	
Abs_ErrID	WORD	

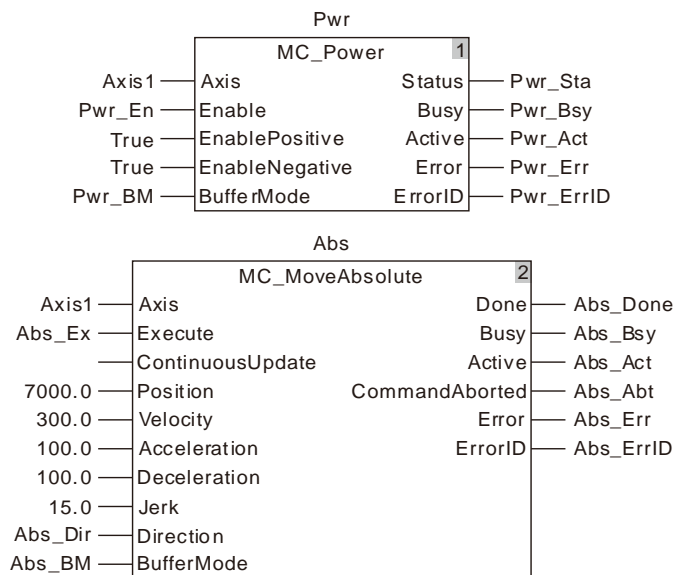

2. Motion Curve and Timing Charts

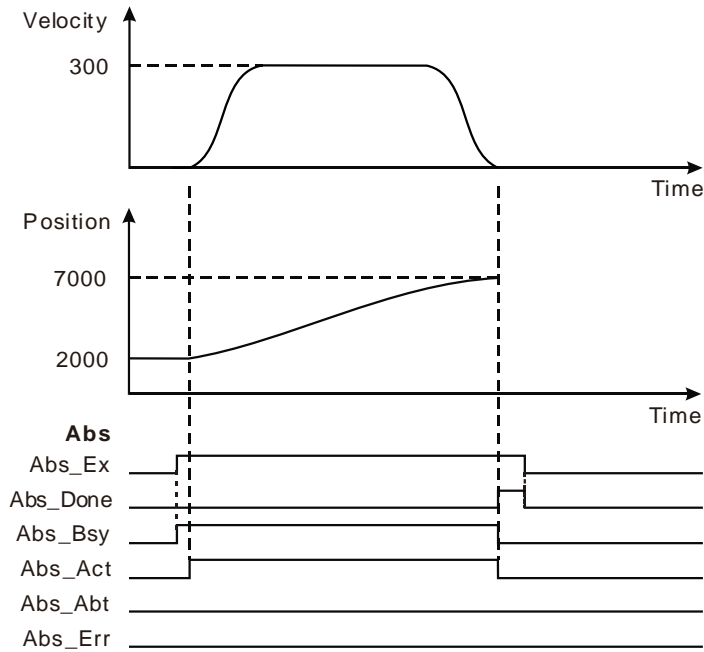

- ❖ When Abs_Ex changes from FALSE to TRUE, MC_MoveAbsolute instruction starts being executed and at the moment, the current position of the axis is 2000 and target position is 7000.
- ❖ The execution of the instruction is completed when the axis reaches 7000.



Programming Example 2

The example on how one MC_MoveAbsolute instruction aborts the execution of another MC_MoveAbsolute instruction is shown below.

1. The variables and program

Variable name	Data type	Initial value
Pwr	MC_Power	
Axis1	USINT	1
Pwr_En	BOOL	FALSE
Pwr_BM	MC_Buffer_Mode	0
Pwr_Sta	BOOL	
Pwr_Bsy	BOOL	
Pwr_Act	BOOL	
Pwr_Err	BOOL	
Pwr_ErrID	WORD	
Abs1	MC_Move Absolute	
Abs1_Ex	BOOL	FALSE
Abs1_Dir	MC_DIRECTION	0
Abs1_BM	MC_Buffer_Mode	0
Abs1_Done	BOOL	
Abs1_Bsy	BOOL	
Abs1_Act	BOOL	
Abs1_Abt	BOOL	
Abs1_Err	BOOL	

Variable name	Data type	Initial value
Abs1_ErrID	WORD	
Abs2	MC_Move Absolute	
Abs2_Ex	BOOL	FALSE
Abs2_Dir	MC_DIRECTION	0
Abs2_BM	MC_Buffer_Mode	0
Abs2_Done	BOOL	
Abs2_Bsy	BOOL	
Abs2_Act	BOOL	
Abs2_Abt	BOOL	
Abs2_Err	BOOL	
Abs2_ErrID	WORD	

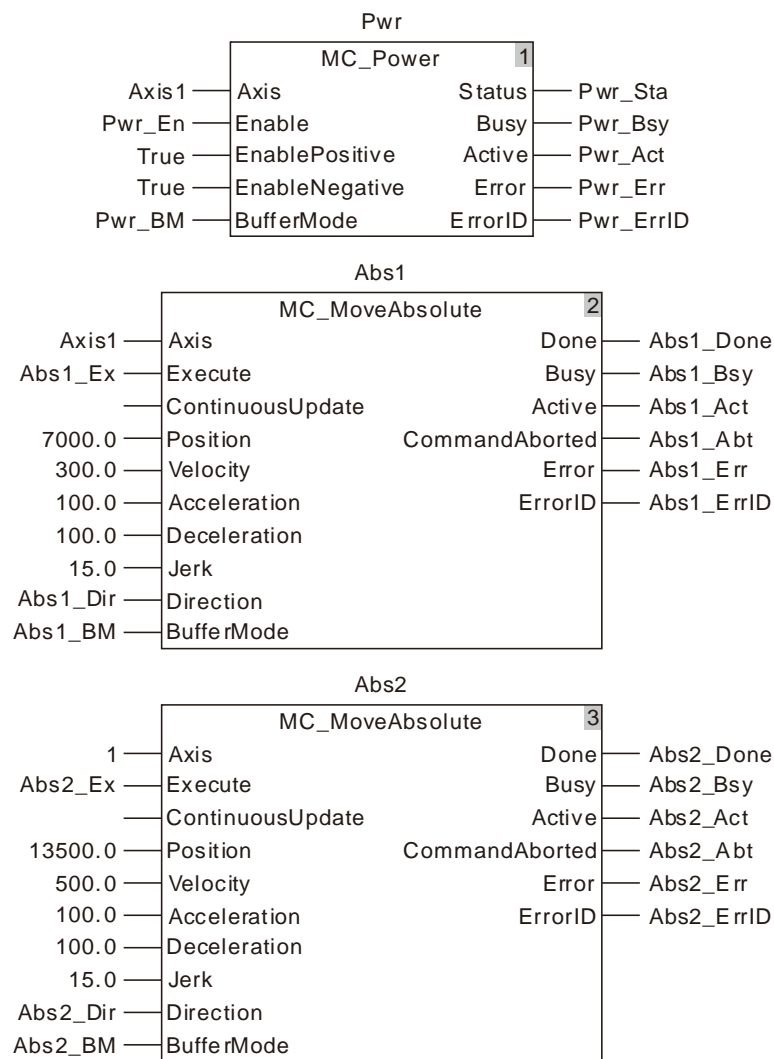

2. Motion Curve and Timing Charts

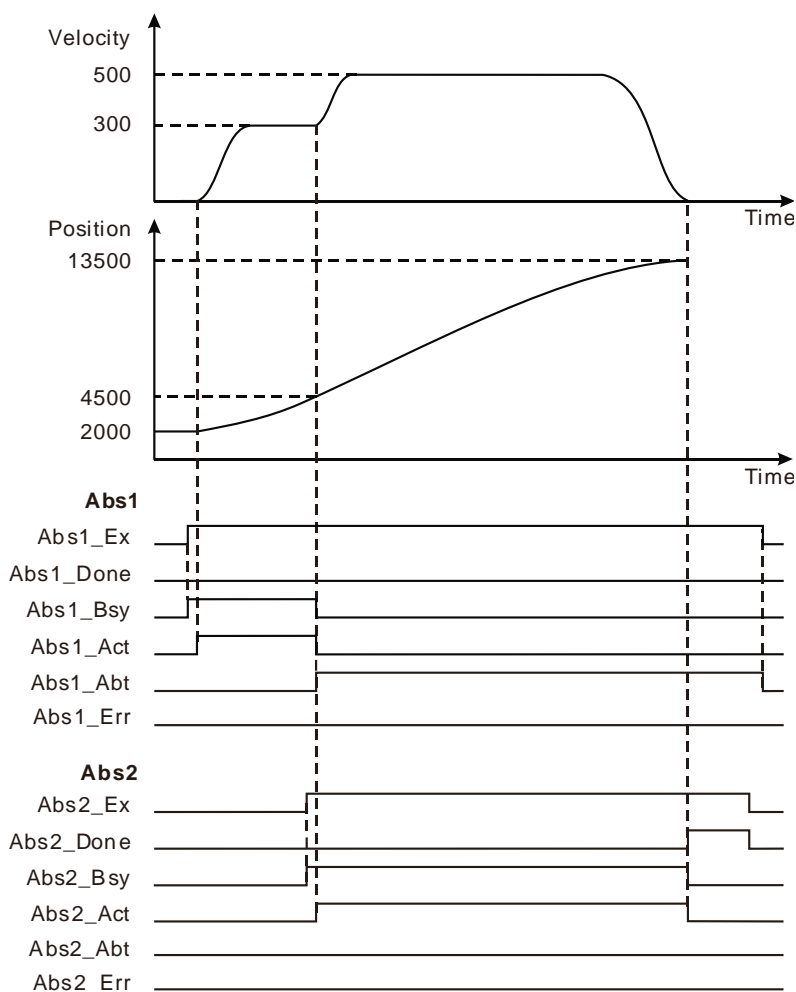

- ❖ When Abs1_Ex changes from FALSE to TRUE, the first MC_MoveAbsolute instruction starts being executed and at the moment, the current position of the axis is 2000 and target position is 7000.
- ❖ When the axis reaches 4500, Abs2_Ex changes from FALSE to TRUE; the second MC_MoveAbsolute instruction starts being executed and the first MC_MoveAbsolute instruction is aborted with its output parameter Abs1_Abt changing to TRUE.
- ❖ When the axis reaches 13500, the execution of the second MC_MoveAbsolute instruction is completed and its output parameter Abs2_Done changes to TRUE.

11.3.9 MC_MoveSuperimposed

FB/FC	Explanation	Applicable model
FB	MC_MoveSuperimposed controls the axis to superimpose the set distance on the current motion state according to the set velocity, acceleration and deceleration.	DVP15MC11T DVP15MC11T-06

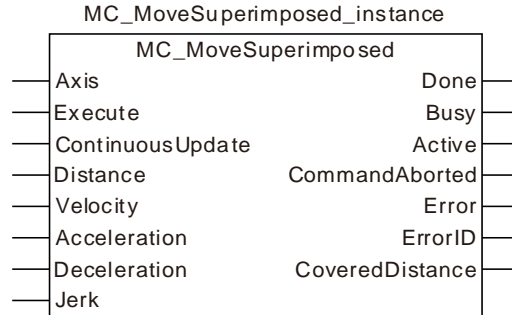

● Input Parameters

Parameter name	Function	Data type	Valid range (Default)	Validation timing
Axis	Specify the number of the axis which is to be controlled.	USINT	Refer to Functions of Section 2.2. (The variable value must be set)	When <i>Execute</i> changes from FALSE to TRUE
Execute	The instruction is executed when <i>Execute</i> changes from FALSE to TRUE.	BOOL	TRUE or FALSE (FALSE)	-
ContinuousUpdate	Reserved	-	-	-
Distance	The distance to superimpose (Unit: Unit)	LREAL	Negative number, positive number and 0 (0)	When <i>Execute</i> changes from FALSE to TRUE
Velocity	Specify the target velocity. (Unit: Unit/second)	LREAL	Positive number (The variable value must be set)	When <i>Execute</i> changes from FALSE to TRUE
Acceleration	Specify the target acceleration rate. (Unit: Unit/s ²)	LREAL	Positive number (The variable value must be set)	When <i>Execute</i> changes from FALSE to TRUE
Deceleration	Specify the target deceleration rate. (Unit: Unit/s ²)	LREAL	Positive number (The variable value must be set)	When <i>Execute</i> changes from FALSE to TRUE
Jerk	Specify the change rate of the target acceleration or deceleration. (Unit: Unit/s ³)	LREAL	Positive number (The variable value must be set)	When <i>Execute</i> changes from FALSE to TRUE

Notes:

1. MC_MoveSuperimposed instruction is executed when *Execute* changes from FALSE to TRUE. There is no impact on the instruction execution when *Execute* of the instruction changes from TRUE to FALSE during execution of the instruction.
2. When *Execute* changes from FALSE to TRUE again during execution of the instruction, there is no impact on the instruction execution and the instruction will go on being executed in the previous way. When *Execute* changes from FALSE to TRUE again after the instruction execution is completed, the instruction can be re-executed.
3. Refer to section 10.2 for the relation among *Velocity*, *Acceleration*, *Deceleration* and *Jerk*.

● Output Parameters

Parameter name	Function	Data type	Valid range
Done	TRUE when the instruction execution is completed.	BOOL	TRUE / FALSE
Busy	TRUE when the instruction is being executed.	BOOL	TRUE/FALSE
Active	TRUE when the axis is being controlled.	BOOL	TRUE / FALSE
CommandAborted	TRUE when the instruction is aborted.	BOOL	TRUE / FALSE
Error	TRUE when an error occurs in execution of the instruction.	BOOL	TRUE / FALSE
ErrorID	Contains the error code when an error occurs. Please refer to section 12.2 for the corresponding error ID.	WORD	-
CoveredDistance	The totally superimposed distance since the instruction is started.	LREAL	Negative number, positive number and 0

● Output Update Timing

Parameter Name	Timing for changing to TRUE	Timing for changing to FALSE
Done	<ul style="list-style-type: none"> ◆ When the superimposed positioning is completed. 	<ul style="list-style-type: none"> ◆ When <i>Execute</i> changes from TRUE to FALSE after the instruction execution is completed. ◆ <i>Done</i> changes to TRUE when the instruction execution is completed after <i>Execute</i> changes from TRUE to FALSE during the instruction execution. One cycle later, <i>Done</i> changes to FALSE.
Busy	<ul style="list-style-type: none"> ◆ When <i>Execute</i> changes to TRUE. 	<ul style="list-style-type: none"> ◆ When <i>Done</i> changes to TRUE. ◆ When <i>Error</i> changes to TRUE. ◆ When <i>CommandAborted</i> changes to TRUE.
Active	<ul style="list-style-type: none"> ◆ When the instruction starts to control the axis. 	<ul style="list-style-type: none"> ◆ When <i>Done</i> changes to TRUE. ◆ When <i>Error</i> changes to TRUE. ◆ When <i>CommandAborted</i> changes to TRUE.
CommandAborted	<ul style="list-style-type: none"> ◆ When this instruction execution is aborted by other motion control instruction. 	<ul style="list-style-type: none"> ◆ When <i>Execute</i> changes from TRUE to FALSE ◆ <i>CommandAborted</i> is set to TRUE when the instruction is aborted after <i>Execute</i> changes from TRUE to FALSE during the instruction execution. One cycle later, <i>CommandAborted</i> changes to FALSE.
Error	<ul style="list-style-type: none"> ◆ When an error occurs in the instruction execution or the input parameters for the instruction are illegal. 	<ul style="list-style-type: none"> ◆ When <i>Execute</i> changes from TRUE to FALSE

● Output Update Timing Chart

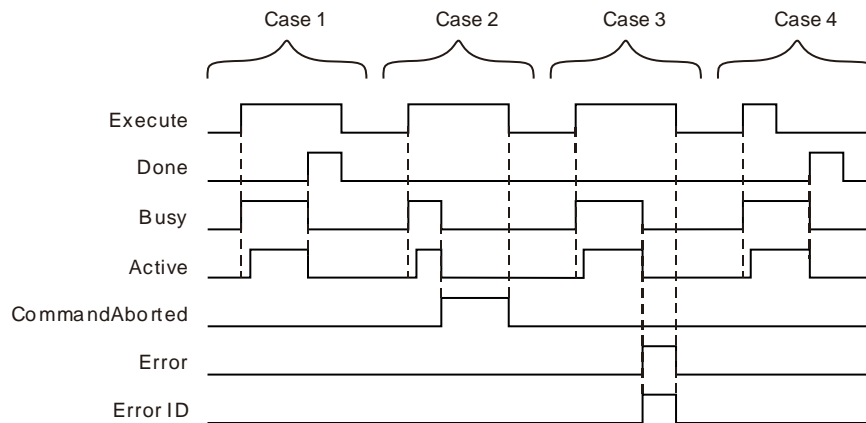

- Case 1 :** When *Execute* changes from FALSE to TRUE, *Busy* changes to TRUE. One cycle later, *Active* changes to TRUE. When the instruction execution is completed, *Done* changes to TRUE and *Busy* and *Active* change to FALSE.
- Case 2 :** When *Execute* changes to TRUE and the instruction is aborted by other instruction, *CommandAborted* changes to TRUE and meanwhile, *Busy* and *Active* change to FALSE. *CommandAborted* changes to FALSE when *Execute* changes from TRUE to FALSE.
- Case 3 :** When an error occurs such as disabled axis as *Execute* is TRUE, *Error* changes to TRUE and *ErrorID* shows corresponding error code. Meanwhile, *Busy* and *Active* change to FALSE. *Error* changes to FALSE and the value of *ErrorID* is cleared to 0 when *Execute* changes from TRUE to FALSE.
- Case 4 :** *Done* changes to TRUE when the instruction execution is completed after *Execute* changes from TRUE to FALSE during execution of the instruction. Meanwhile, *Busy* and *Active* change to FALSE and one cycle later, *Done* changes to FALSE.

● Function

The MC_MoveSuperimposed instruction controls the axis to independently superimpose the set distance on the current motion state according to the set velocity, acceleration and deceleration.

1. When MC_MoveSuperimposed instruction is executed, the execution of the previous instruction excluding MC_MoveSuperimposed and MC_HaltSuperimposed instructions is not aborted. If the two instructions are executed simultaneously, their distances, velocities, accelerations and decelerations will be respectively added up in real time. When the set velocity of either of the instructions is reached, the acceleration of the instruction will be 0. If the previous instruction execution is finished, the velocities, accelerations and decelerations will not be added up any more and MC_MoveSuperimposed instruction continues running independently.
2. If MC_MoveSuperimposed instruction is executed when the axis is in Standstill state, the execution effect of MC_MoveSuperimposed instruction is equivalent to that of MC_MoveRelative instruction.
3. Execute another motion instruction excluding MC_MoveSuperimposed and MC_HaltSuperimposed instructions when MC_MoveSuperimposed instruction and one motion instruction jointly control the axis. If the *Buffermode* value of the lately executed motion instruction is 0, both of the MC_MoveSuperimposed instruction and the previously executed motion instruction will be aborted. If the *Buffermode* value of the lately executed motion instruction is another number except 0, the MC_MoveSuperimposed instruction and the previously executed motion instruction will not be aborted.
4. If another MC_MoveSuperimposed instruction is executed when one MC_MoveSuperimposed instruction and another motion instruction jointly control the axis, the previous MC_MoveSuperimposed instruction will be aborted but other motion instruction will not be affected.

5. If another MC_MoveSuperimposed instruction is executed when one MC_MoveSuperimposed instruction controls the axis independently, the previous MC_MoveSuperimposed instruction will be aborted.
6. If the MC_HaltSuperimposed instruction is executed in the course of execution of MC_MoveSuperimposed instruction, the MC_MoveSuperimposed instruction will be aborted.
7. MC_MoveSuperimposed can be executed on the slave axis specified by MC_GearIn instruction and MC_CamIn instruction.

 **Programming Example 1**

The programming example is as follows when one MC_MoveSuperimposed instruction is used.

1. The variable table and program

Variable name	Data type	Initial value
Pwr	MC_Power	
Axis1	USINT	1
Pwr_En	BOOL	FALSE
Pwr_BM	MC_Buffer_Mode	0
Pwr_Sta	BOOL	
Pwr_Bsy	BOOL	
Pwr_Act	BOOL	
Pwr_Err	BOOL	
Pwr_ErrID	WORD	
Sup	MC_MoveSuperimposed	
Sup_Ex	BOOL	FALSE
Sup_Done	BOOL	
Sup_Bsy	BOOL	
Sup_Act	BOOL	
Sup_Abt	BOOL	
Sup_Err	BOOL	
Sup_ErrID	WORD	
Sup_Distan	LREAL	

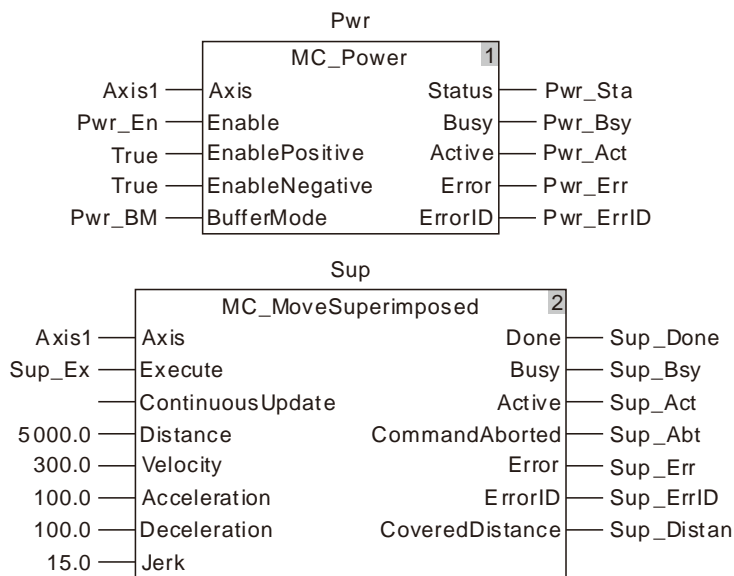

2. Motion Curve and Timing Chart:

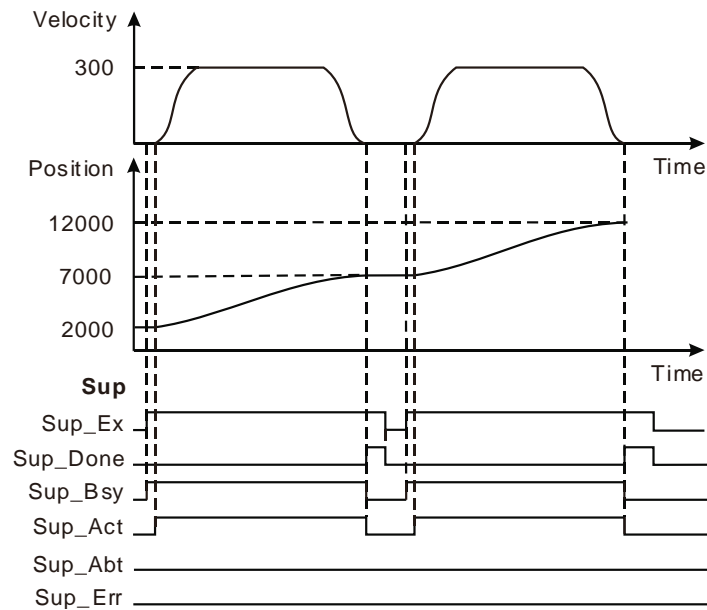

- ❖ When Sup_Ex changes to TRUE, Sup_Bsy changes to TRUE. One cycle later, Sup_Act changes to TRUE and the motion controller controls the servo motor to run by using current position as the reference point.
- ❖ After the servo motor completes the superimposed positioning, Sup_Done changes to TRUE and meanwhile Sup_Bsy and Sup_Act change to FALSE.
- ❖ When Sup_Ex changes to FALSE, Sup_Done changes to FALSE.
- ❖ When Sup_Ex changes to TRUE again after the servo motor completes the set distance, the motion controller controls the servo motor to run. When the servo motor completes the set distance, Sup_Done changes to TRUE again.



Programming Example 2

Below is the example that MC_MoveSuperimposed and MC_MoveRelative instructions are matched.

1. The variable table and program

Variable name	Data type	Initial value
Pwr	MC_Power	
Axis1	USINT	1
Pwr_En	BOOL	FALSE
Pwr_BM	MC_Buffer_Mode	0
Pwr_Sta	BOOL	
Pwr_Bsy	BOOL	
Pwr_Act	BOOL	
Pwr_Err	BOOL	
Pwr_ErrID	WORD	
Rel	MC_MoveRelative	
Rel_Ex	BOOL	FALSE
Rel_Done	BOOL	
Rel_Bsy	BOOL	
Rel_Act	BOOL	
Rel_Abt	BOOL	
Rel_Err	BOOL	
Rel_ErrID	WORD	

Variable name	Data type	Initial value
Sup	MC_MoveSuperimposed	
Sup_Ex	BOOL	FALSE
Sup_Done	BOOL	
Sup_Bsy	BOOL	
Sup_Act	BOOL	
Sup_Abt	BOOL	
Sup_Err	BOOL	
Sup_ErrID	WORD	
Sup_Distan	LREAL	

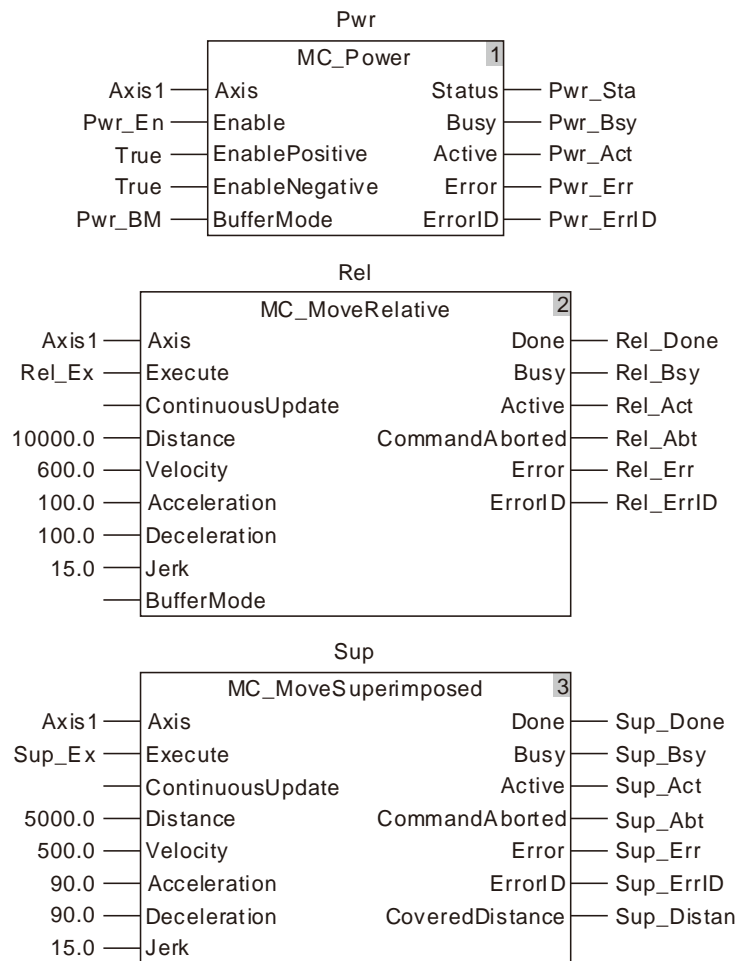

2. Motion Curve and Timing Chart:

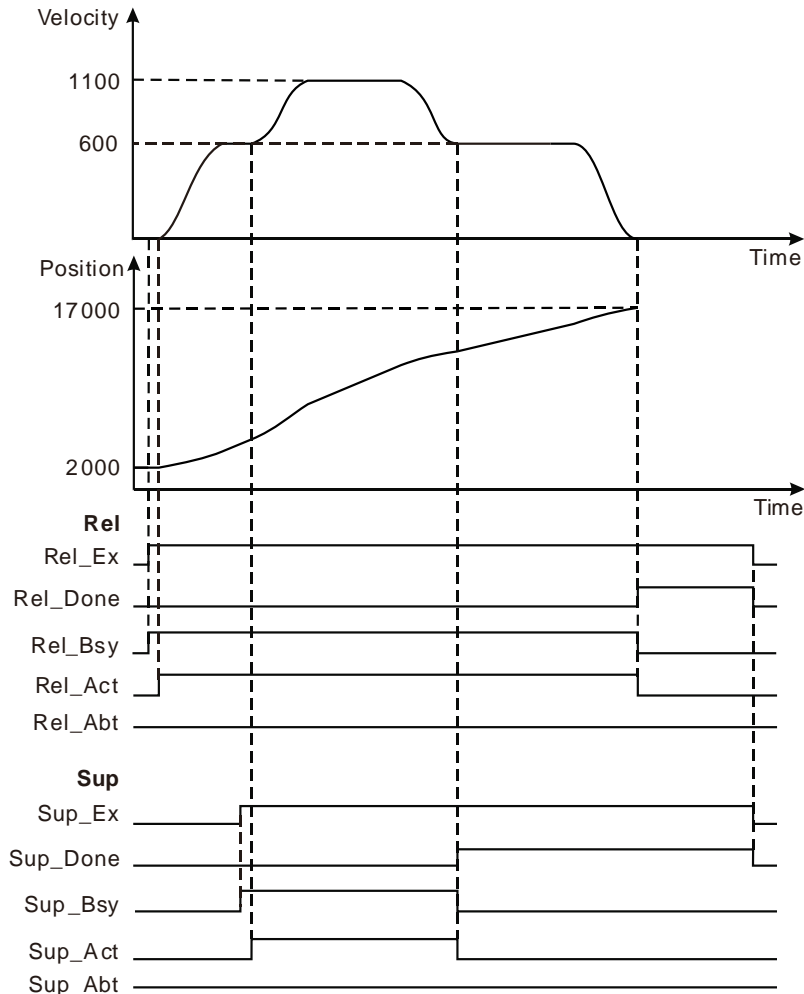

- ❖ When Rel_Ex changes to TRUE, Rel_Bsy changes to TRUE. One period later, Rel_Act changes to TRUE and the motion controller controls the servo motor rotation by using the current position as the reference point.
- ❖ When Sup_Ex changes to TRUE, Sup_Bsy changes to TRUE. One cycle later, Sup_Act changes to TRUE and the the MC_MoveSuperimposed instruction starts to control the axis. The velocity and acceleration (0 at the moment) for the servo motor are the sums of the velocities and accelerations of the two instructions respectively.
- ❖ When the superimposed distance specified by the MC_MoveSuperimposed instruction is completed, Sup_Done changes to TRUE and Sup_Bsy and Sup_Act change to FALSE.
- ❖ When the distance specified by the MC_MoveRelative instruction is completed, Rel_Done changes to TRUE and Rel_Bsy and Rel_Act change to FALSE. The final position of the axis is the sum of the distances of the two instructions plus the start position.
- ❖ When Rel_Ex changes to FALSE, Rel_Done changes to FALSE. When Sup_Ex changes to FALSE, Sup_Done changes to FALSE.

11.3.10 MC_HaltSuperimposed

FB/FC	Explanation	Applicable model
FB	MC_HaltSuperimposed halts the execution of the MC_MoveSuperimposed instruction.	DVP15MC11T DVP15MC11T-06

11

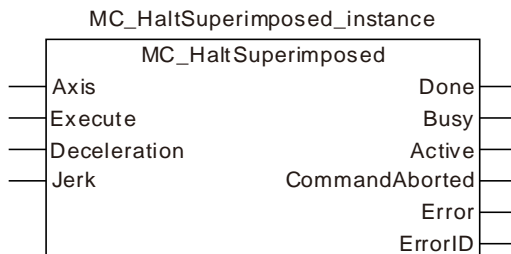

● **Input Parameters**

Parameter name	Function	Data type	Valid range (Default)	Validation timing
Axis	Specify the number of the axis which is to be controlled.	USINT	Refer to Functions of Section 2.2. (The variable value must be set)	When <i>Execute</i> changes from FALSE to TRUE
Execute	The instruction is executed when <i>Execute</i> changes from FALSE to TRUE.	BOOL	TRUE or FALSE (FALSE)	-
Deceleration	Specify the target deceleration rate. (Unit: Unit/s ²)	LREAL	Positive number (The variable value must be set)	When <i>Execute</i> changes from FALSE to TRUE
Jerk	Specify the change rate of the target deceleration. (Unit: Unit/s ³)	LREAL	Positive number (The variable value must be set)	When <i>Execute</i> changes from FALSE to TRUE

Notes:

1. MC_HaltSuperimposed instruction is executed when *Execute* changes from FALSE to TRUE. There is no impact on the instruction execution when *Execute* of the instruction changes from TRUE to FALSE during execution of the instruction.
2. Refer to section 10.2 for the relation between *Deceleration* and *Jerk*.

● **Output Parameters**

Parameter name	Function	Data type	Valid range
Done	TRUE when the instruction execution is completed.	BOOL	TRUE / FALSE
Busy	TRUE when the instruction is being executed.	BOOL	TRUE/FALSE
Active	TRUE when the axis is being controlled.	BOOL	TRUE / FALSE
CommandAborted	TRUE when the instruction is aborted.	BOOL	TRUE / FALSE
Error	TRUE when an error occurs in execution of the instruction.	BOOL	TRUE / FALSE
ErrorID	Contains the error code when an error occurs. Please refer to section 12.2 for the corresponding error ID.	WORD	-

● Output Update Timing

Parameter Name	Timing for changing to TRUE	Timing for changing to FALSE
Done	◆ When the instruction execution is completed.	◆ When <i>Execute</i> changes from TRUE to FALSE after the instruction execution is completed. ◆ <i>Done</i> changes to TRUE when the instruction execution is completed after <i>Execute</i> changes from TRUE to FALSE during the instruction execution. One cycle later, <i>Done</i> changes to FALSE.
Busy	◆ When <i>Execute</i> changes to TRUE.	◆ When <i>Done</i> changes to TRUE. ◆ When <i>Error</i> changes to TRUE. ◆ When <i>CommandAborted</i> changes to TRUE.
Active	◆ When the instruction starts to control the axis.	◆ When <i>Done</i> changes to TRUE. ◆ When <i>Error</i> changes to TRUE. ◆ When <i>CommandAborted</i> changes to TRUE.
CommandAborted	◆ When this instruction execution is aborted by other motion control instruction.	◆ When <i>Execute</i> changes from TRUE to FALSE ◆ <i>CommandAborted</i> is set to TRUE when the instruction is aborted after <i>Execute</i> changes from TRUE to FALSE during the instruction execution. One cycle later, <i>CommandAborted</i> changes to FALSE.
Error	◆ When an error occurs in the instruction execution or the input parameters for the instruction are illegal.	◆ When <i>Execute</i> changes from TRUE to FALSE

● Output Update Timing Chart

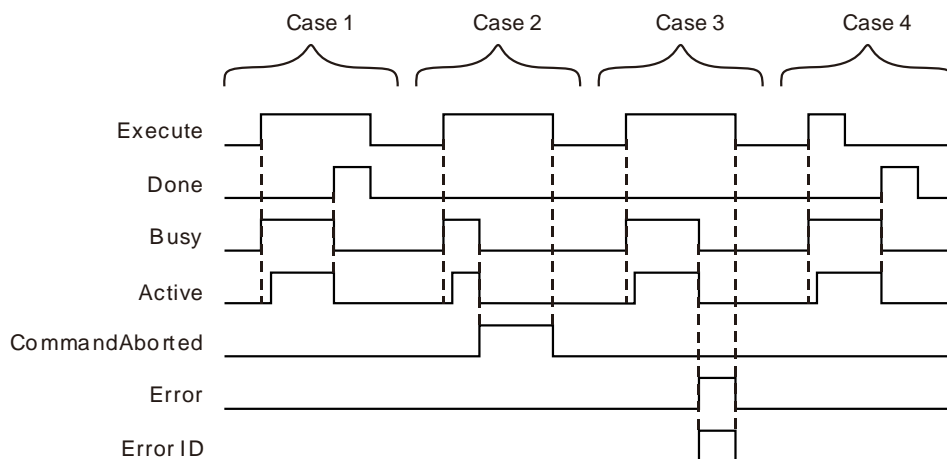

Case 1 : When *Execute* changes from FALSE to TRUE, *Busy* changes to TRUE. One cycle later, *Active* changes to TRUE. When the instruction execution is completed, *Done* changes to TRUE and *Busy* and *Active* change to FALSE.

- Case 2 :** When *Execute* changes to TRUE and the instruction is aborted by other instruction, *CommandAborted* changes to TRUE and meanwhile, *Busy* and *Active* change to FALSE. *CommandAborted* changes to FALSE when *Execute* changes from TRUE to FALSE.
- Case 3 :** When an error occurs such as axis disabled as *Execute* is TRUE, *Error* changes to TRUE and *ErrorID* shows corresponding error code. Meanwhile, *Busy* and *Active* change to FALSE. *Error* changes to FALSE when *Execute* changes from TRUE to FALSE.
- Case 4 :** *Done* changes to TRUE when the instruction execution is completed after *Execute* changes from TRUE to FALSE in the course of execution of the instruction. Meanwhile, *Busy* and *Active* change to FALSE and one cycle later, *Done* changes to FALSE.

● **Function**

The MC_HaltSuperimposed instruction is used to halt the execution of the MC_MoveSuperimposed instruction.

- The MC_HaltSuperimposed instruction cannot be executed alone and it can only be used with the MC_MoveSuperimposed instruction together.
- If the MC_HaltSuperimposed instruction is executed when the MC_MoveSuperimposed instruction and other motion instruction jointly control the axis, the MC_HaltSuperimposed instruction will abort the MC_MoveSuperimposed instruction but other motion instruction execution will not be affected.
- The MC_HaltSuperimposed instruction can halt the execution of the MC_HaltSuperimposed instruction.



Programming Example

The programming example is as follows when one MC_HaltSuperimposed instruction is used.

1. The variable table and program

Variable name	Data type	Initial value
Pwr	MC_Power	
Axis1	USINT	1
Pwr_En	BOOL	FALSE
Pwr_BM	MC_Buffer_Mode	0
Pwr_Sta	BOOL	
Pwr_Bsy	BOOL	
Pwr_Act	BOOL	
Pwr_Err	BOOL	
Pwr_ErrID	WORD	
Rel	MC_MoveRelative	
Rel_Ex	BOOL	FALSE
Rel_Done	BOOL	
Rel_Bsy	BOOL	
Rel_Act	BOOL	
Rel_Abt	BOOL	
Rel_Err	BOOL	
Rel_ErrID	WORD	
Sup	MC_MoveSuperimposed	
Sup_Ex	BOOL	FALSE
Sup_Done	BOOL	
Sup_Bsy	BOOL	
Sup_Act	BOOL	
Sup_Abt	BOOL	
Sup_Err	BOOL	

Variable name	Data type	Initial value
Sup_ErrID	WORD	
Sup_Distan	LREAL	
HltSup	MC_HaltSuperimposed	
HltSup_Ex	BOOL	FALSE
HltSup_Done	BOOL	
HltSup_Bsy	BOOL	
HltSup_Act	BOOL	
HltSup_Abt	BOOL	
HltSup_Err	BOOL	
HltSup_ErrID	WORD	

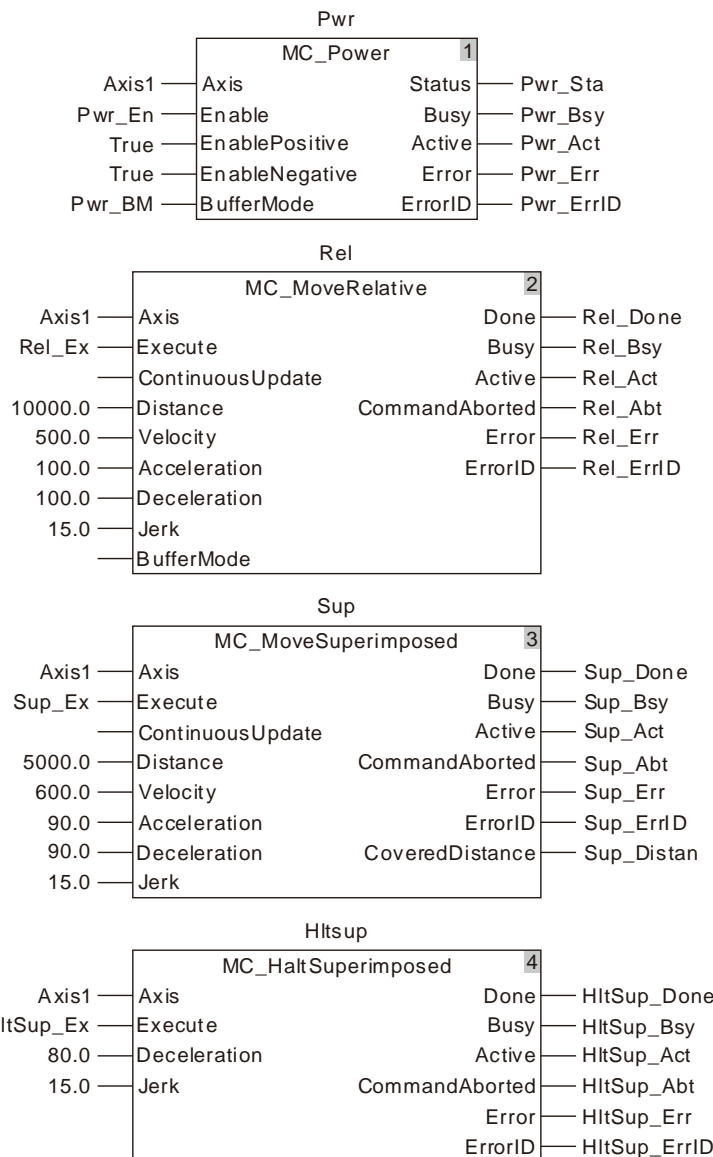

2. Motion Curve and Timing Chart

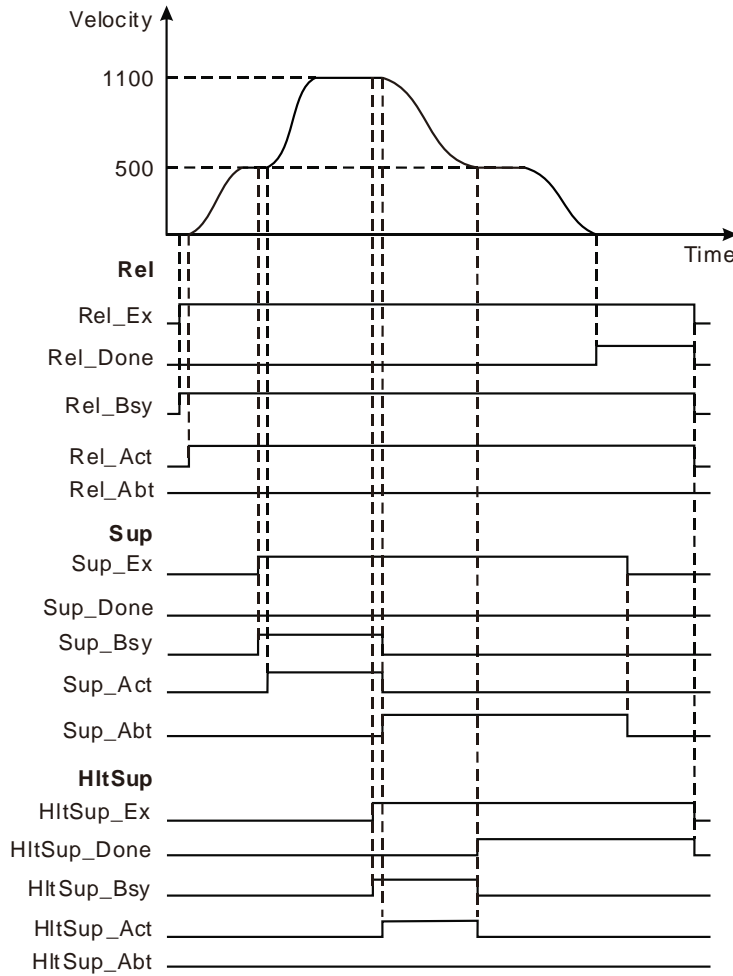

- ❖ When Rel_Ex changes to TRUE, Rel_Bsy changes to TRUE. One cycle later, Rel_Act changes to TRUE and the motion controller controls the servo motor rotation by using the current position as the reference point. When Sup_Ex changes to TRUE, Sup_Bsy changes to TRUE. One cycle later, Sup_Act changes to TRUE, the execution of the MC_MoveSuperimposed instruction starts and the velocities and accelerations (0 at the moment) for the servo motor will be added up respectively.
- ❖ When HltSup_Ex changes to TRUE, HltSup_Bsy changes to TRUE. One cycle later, HltSup_Act changes to TRUE, the execution of the MC_HaltSuperimposed instruction starts, the MC_MoveSuperimposed instruction is aborted and Sup_Bsy and Sup_Act change to FALSE and meanwhile, Sup_Abt changes to TRUE. The execution of the MC_MoveSuperimposed instruction is halted by the MC_HaltSuperimposed instruction.
- ❖ When HltSup_Done changes to TRUE, HltSup_Bsy and HltSup_Act change to FALSE.
- ❖ The execution of the MC_HaltSuperimposed instruction has no impact on the being executed MC_MoveRelative instruction.

11.3.11 MC_SetPosition

FB/FC	Explanation	Applicable model
FB	MC_SetPosition is used to set the position of the axis to a given value and no actual axis motion is brought accordingly.	DVP15MC11T DVP15MC11T-06

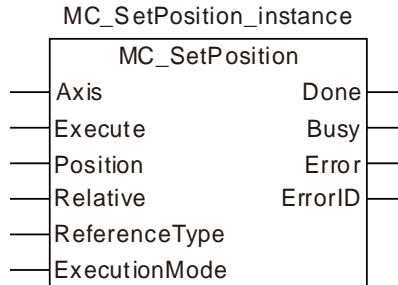

● Input Parameters

Parameter name	Function	Data type	Valid range (Default)	Validation timing
Axis	Specify the number of the axis which is to be controlled	USINT	Refer to Functions of Section 2.2. (The variable value must be set)	When <i>Execute</i> changes from FALSE to TRUE
Execute	The instruction is executed when <i>Execute</i> changes from FALSE to TRUE.	BOOL	TRUE or FALSE (FALSE)	-
Position	Specify the target Position. (Unit: Unit)	LREAL	Negative number, positive number or 0 (0)	When <i>Execute</i> changes from FALSE to TRUE
Relative	Specify the relative mode or absolute mode for the target position and current position.	BOOL	TRUE or FALSE (FALSE)	When <i>Execute</i> changes from FALSE to TRUE
ReferenceType	Specify the position type for reference.	MC_ReferenceType	0: mcCommand Position 1: mcActual Position (0)	When <i>Execute</i> changes from FALSE to TRUE
ExecutionMode	Reserved			

● Output Parameters

Parameter name	Function	Data type	Valid range
Done	TRUE when the instruction is completed.	BOOL	TRUE / FALSE
Busy	TRUE while the instruction is being executed.	BOOL	TRUE / FALSE
Error	TRUE while there is an error.	BOOL	TRUE / FALSE
ErrorID	Contains error codes when an error occurs. Please refer to section 12.2 for the corresponding error code.	WORD	

● **Output Update Timing**

Parameter Name	Timing for changing to TRUE	Timing for changing to FALSE
Done	◆ When positioning is completed	◆ When <i>Execute</i> changes from TRUE to FALSE after the instruction execution is finished. ◆ <i>Done</i> changes to TRUE when the instruction execution is completed after <i>Execute</i> changes from TRUE to FALSE during the instruction execution. One period later, <i>Done</i> changes to FALSE.
Busy	◆ When <i>Execute</i> changes to TRUE	◆ When <i>Done</i> changes to TRUE. ◆ When <i>Error</i> changes to TRUE.
Error	◆ When an error occurs in the instruction execution or the input parameters for the instruction are illegal.	◆ When <i>Execute</i> changes from TRUE to FALSE.

● **Output Update Timing Chart**

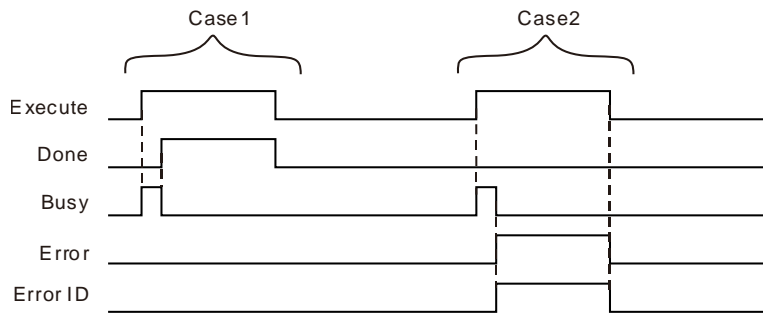

Case 1 : When *Execute* changes from FALSE to TRUE, *Busy* changes to TRUE and one period later, *Done* changes to TRUE and meanwhile, *Busy* changes to FALSE.

Case 2 : When an error occurs as *Execute* is TRUE, *Error* changes to TRUE and *ErrorID* shows the corresponding error code. And meanwhile, *Busy* changes to FALSE. *Error* changes to FALSE when *Execute* changes from TRUE to FALSE.

● **Function**

MC_SetPosition is used to set the position of the axis to a given value and no actual motion of the axis is incurred. MC_SetPosition execution does not affect the current motion. However, it has an impact on the actual execution effect of the instruction which is executed after MC_SetPosition execution is completed.

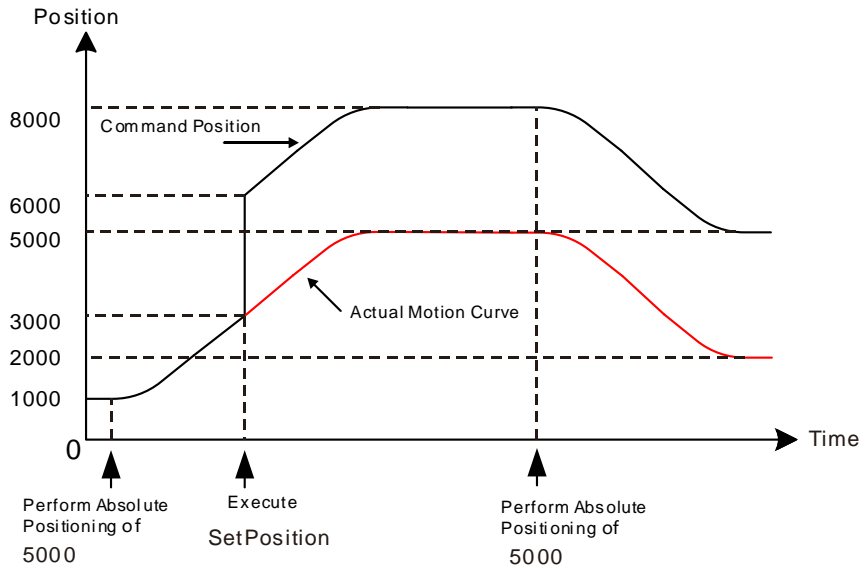

■ Relationship between *Position* and *Relative*

Position, *Relative* and reference position which stands for the axis position at the moment when the instruction starts being executed jointly determine the position setting value.

Relative is used to define the relationship between *Position* and reference position. When *Relative* is set to TRUE, it is a relative relationship between *Position* and reference position and the position setting value = reference position + *Position*. When *Relative* is FALSE, it is an absolute relationship between *Position* and reference position and the position setting value equals *Position*.

As shown in the following figures, the reference position is set to 10000 and the value of *Position* is 6000 for the instruction execution. The corresponding execution results are respectively illustrated for different *Relative* values as below.

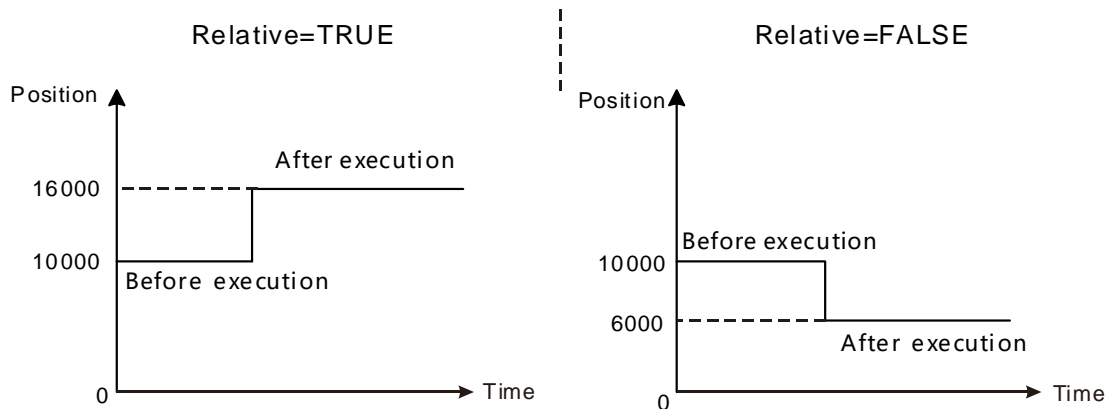

■ ReferenceType

ReferenceType is used to select the command position or actual position as the reference position. When *ReferenceType* is 0, the reference position is the command position of the axis. When *ReferenceType* is 1, the reference position is the actual position of the axis.

When the command position is taken as the reference position, the instruction calculates the target command position based on the current command position and the value of *Position* and it revises the command position value into the target position value. Meantime, the actual position of the axis will change accordingly. The law of the change is that the variation amount of the actual position is the same as that of the command position. That is to say that the deviation between the command position

and actual position remains unchanged at the time when the instruction is executed and the instruction execution ends.

The solution for the actual position which is taken as the reference position is the same as that for the command position which is taken as the reference position.

There will be no difference in execution effect between the command position and actual position as the reference position if the axis is in Standstill state as MC_SetPosition is executed. That is because the difference is 0 between command position and actual position as the axis is still.

The differences in execution effect between command position and actual position as the reference position exist as illustrated below if the axis is in motion as MC_SetPosition is executed. If not zero, the difference between command position and actual position is caused by the command response time.

When MC_SetPosition is executed in absolute mode with *Position* set to 6000 while the axis is positioning with the target position of 5000, the command position and actual position of the axis are 3000 and 2300 respectively (difference value $\Delta P = 700$). The command position changes to 6000 and actual position becomes 5300 ($5300 = 6000 - \Delta P$) after the instruction is executed if the reference position is the command position as the following left figure shows.

The actual position of the axis changes to 6000 and command position becomes 6700 ($6700 = 6000 + \Delta P$) after the instruction is executed if the reference position is the actual position as the following right figure shows.

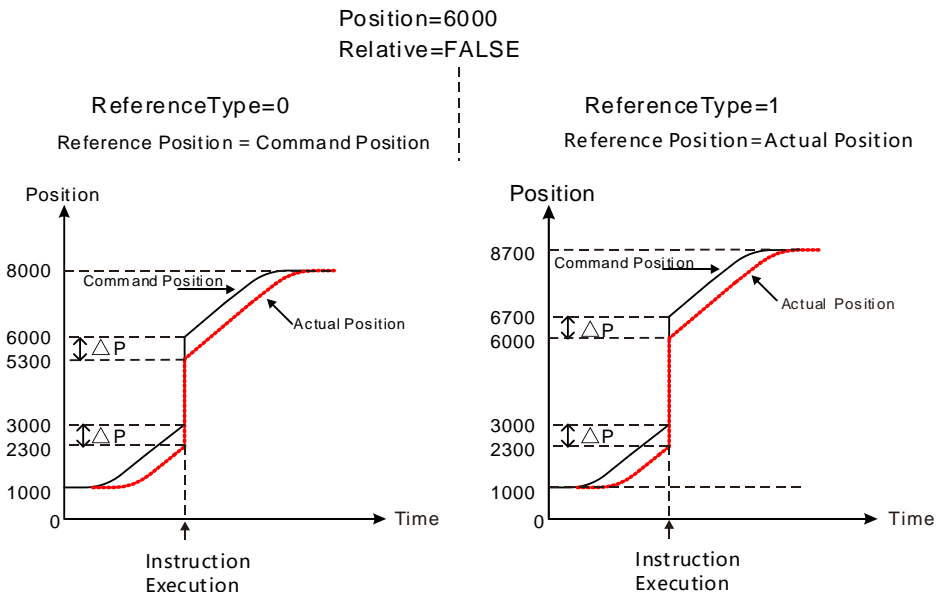

■ Relationship between Axis Type and Reference Type

Different axis types are applicable to different reference types as shown in the following table.

Axis type	Reference Type	
	Command Position	Actual Position
Real axis	YES	YES
Encoder axis	YES	YES
Virtual axis	YES	YES

There will be an error in the instruction execution if the axis on which MC_SetPosition is executed does not support the selected Reference Type.

■ Explanation of Instruction Application Situation

When MC_SetPosition is executed on the master axis which is in the built multi-axis relationship, the master axis position change incurred by the instruction does not affect the slave axis. That is, the slave axis will make any motion accordingly when the master axis position change incurred by MC_SetPosition.

When MC_SetPosition is executed on the slave axis, the slave axis position will change but the original relationship between slave axis and master axis will not be influenced.

MC_SetPosition will report an error when it is executed in the process of execution of MC_Stop. But MC_SetPosition can be executed normally after MC_Stop execution is completed.



Programming Example 1

The following example shows the impact of MC_SetPosition execution on the positioning instruction when *Relative* of MC_SetPosition instruction is TRUE.

1. The variable table and program

Variable name	Data type	Initial value
Rel	MC_MoveRelative	
Axis1	USINT	1
Rel_Ex	BOOL	FALSE
Rel_Done	BOOL	
Rel_Bsy	BOOL	
Rel_Act	BOOL	
Rel_Abt	BOOL	
Rel_Err	BOOL	
Rel_ErrID	WORD	
Tn	TON	
Tn_In	BOOL	FALSE
SRe	SR	
SRe_Q	BOOL	
SetPos	SetPosition	
SetPos_Ex	BOOL	FALSE
SetPos_RefTp	MC_REFERECNE TYPE	0
SetPos_Done	BOOL	
SetPos_Bsy	BOOL	
SetPos_Err	BOOL	
SetPos_ErrID	WORD	

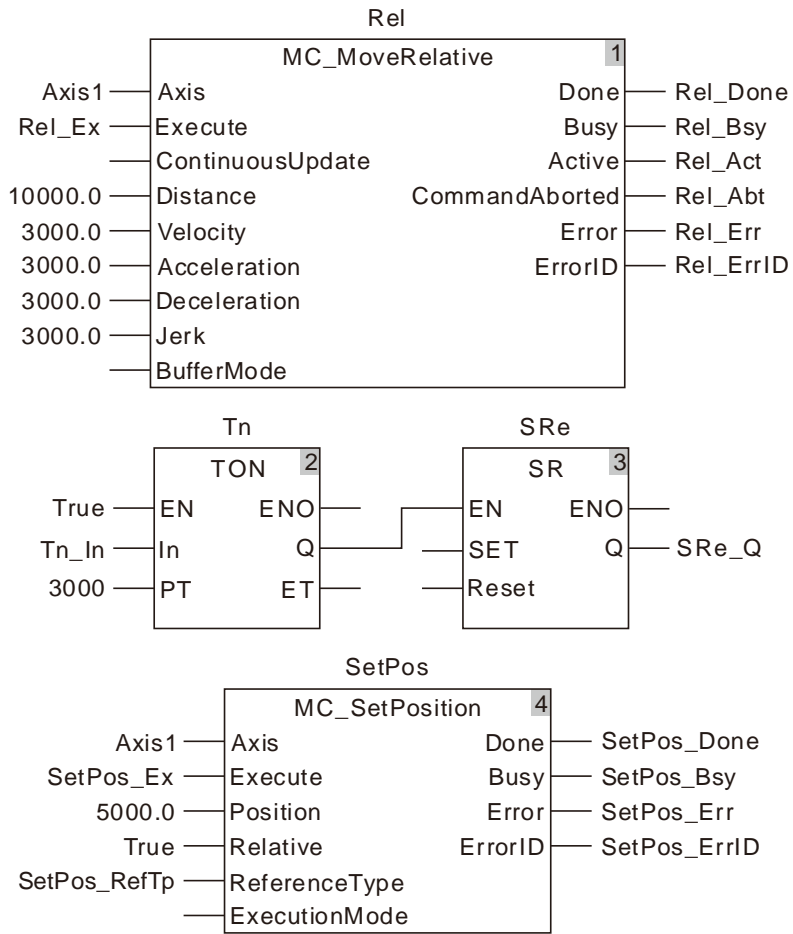

2. Motion Curve and Timing Charts:

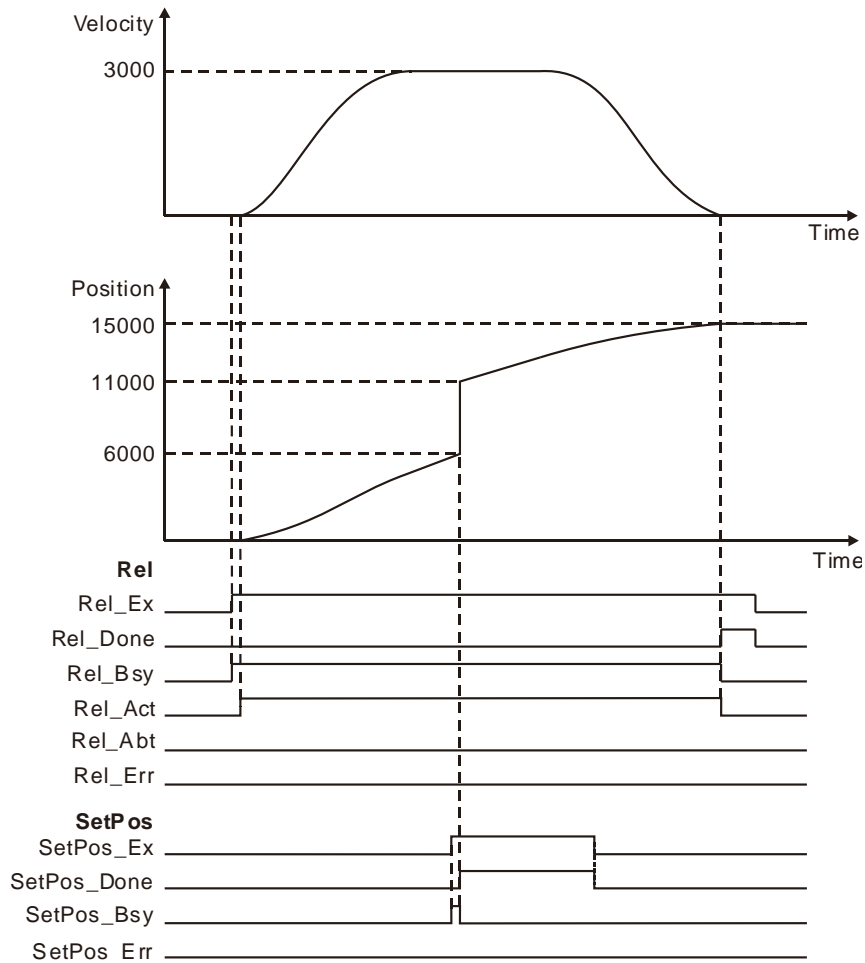

- ❖ As Rel_Ex changes from FALSE to TRUE, the execution of MC_MoveRelative instruction is started and MC_SetPosition is executed 3 seconds later after MC_MoveRelative is executed.
- ❖ The command position is 6000 as MC_SetPosition starts being executed and 11000 (11000=6000+5000) after the instruction execution ends. The position is 15000 as MC_MoveRelative execution ends.
- ❖ MC_SetPosition does not affect the motion which is being performed through observing the above velocity change curve.



Programming Example 2

The following example describes the impact of MC_SetPosition execution on the axis position when *Relative* of MC_SetPosition instruction is FALSE (the absolute mode is chosen for MC_SetPosition).

1. The variable table and program

Variable name	Data type	Initial value
Rel	MC_MoveRelative	
Axis1	USINT	1
Rel_Ex	BOOL	FALSE
Rel_Done	BOOL	
Rel_Bsy	BOOL	
Rel_Act	BOOL	
Rel_Abt	BOOL	
Rel_Err	BOOL	

Variable name	Data type	Initial value
Rel_ErrID	WORD	
Tn	TON	
Tn_In	BOOL	FALSE
SRe	SR	
SRe_Q	BOOL	
SetPos	SetPosition	
SetPos_Ex	BOOL	FALSE
SetPos_RefTp	MC_REFERECNETYPE	0
SetPos_Done	BOOL	
SetPos_Bsy	BOOL	
SetPos_Err	BOOL	
SetPos_ErrID	WORD	

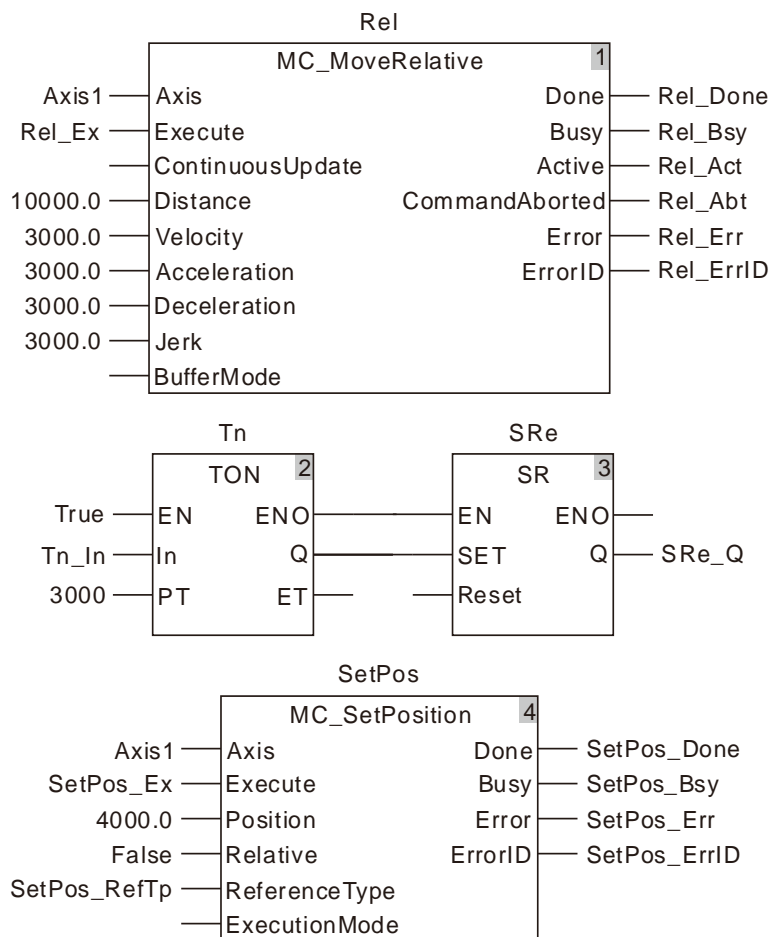

2. Motion Curve and Timing Charts:

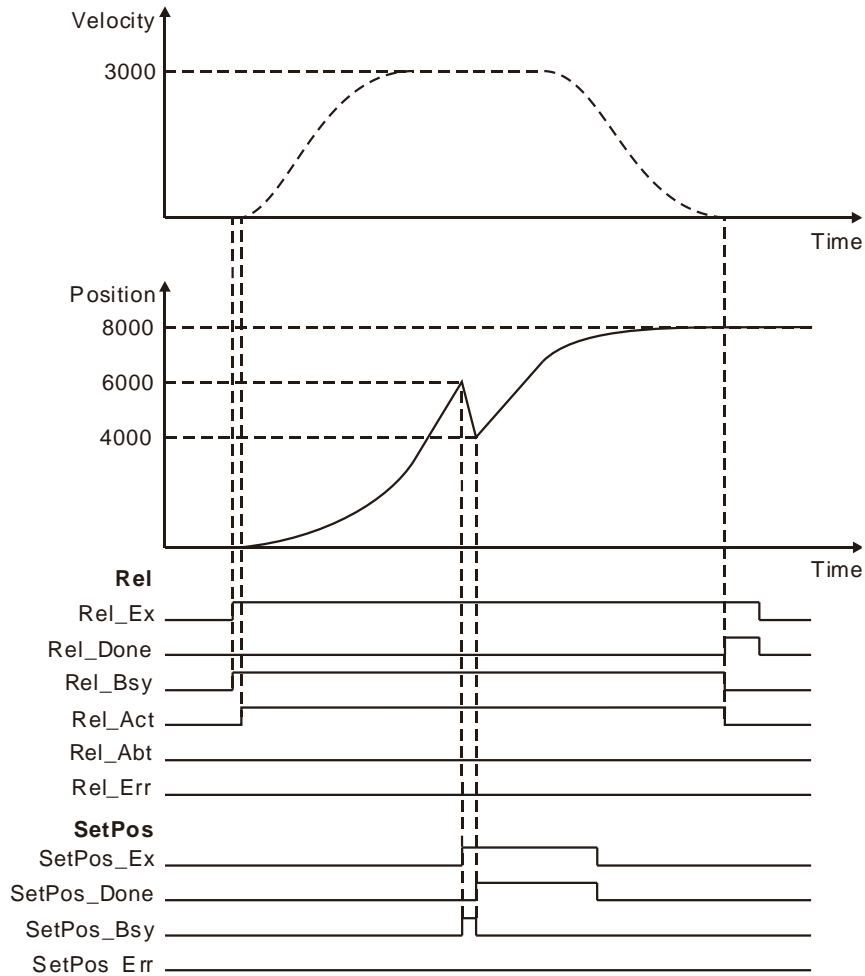

- ❖ As Rel_Ex changes from FALSE to TRUE, MC_MoveRelative instruction execution starts and MC_SetPosition is executed 3 seconds later after MC_MoveRelative is executed.
- ❖ The command position is 6000 as MC_SetPosition starts being executed and 4000 after the instruction execution is completed. The position is 8000 as MC_MoveRelative execution ends.
- ❖ MC_SetPosition does not affect the motion which is being performed through observing the above velocity change curve.



Programming Example 3

The following example shows how MC_SetPosition execution affects MC_MoveAbsolute instruction which is being executed. The actual execution effect of MC_MoveAbsolute which is being executed is not be impacted by MC_SetPosition.

1. The variable table and program

Variable name	Data type	Initial value
Abs	MC_MoveAbsolute	
Axis1	USINT	1
Abs_Ex	BOOL	FALSE
Abs_Dir	MC_DIRECTION	1
Abs_Done	BOOL	
Abs_Bsy	BOOL	
Abs_Act	BOOL	

Variable name	Data type	Initial value
Abs_Abt	BOOL	
Abs_Err	BOOL	
Abs_ErrID	WORD	
Tn	TON	
Tn_In	BOOL	FALSE
SRe	SR	
SRe_Q	BOOL	
SetPos	SetPosition	
SetPos_Ex	BOOL	FALSE
SetPos_RefTp	MC_REFERECNETYPE	0
SetPos_Done	BOOL	
SetPos_Bsy	BOOL	
SetPos_Err	BOOL	
SetPos_ErrID	WORD	

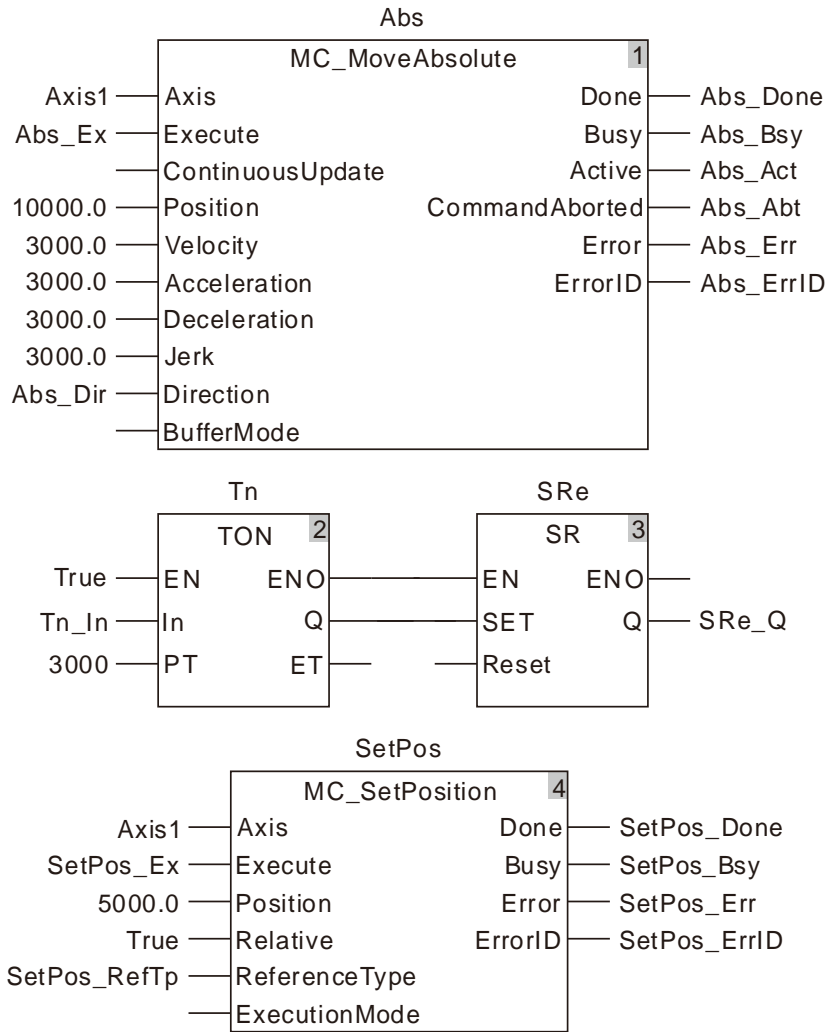

2. Motion Curve and Timing Charts:

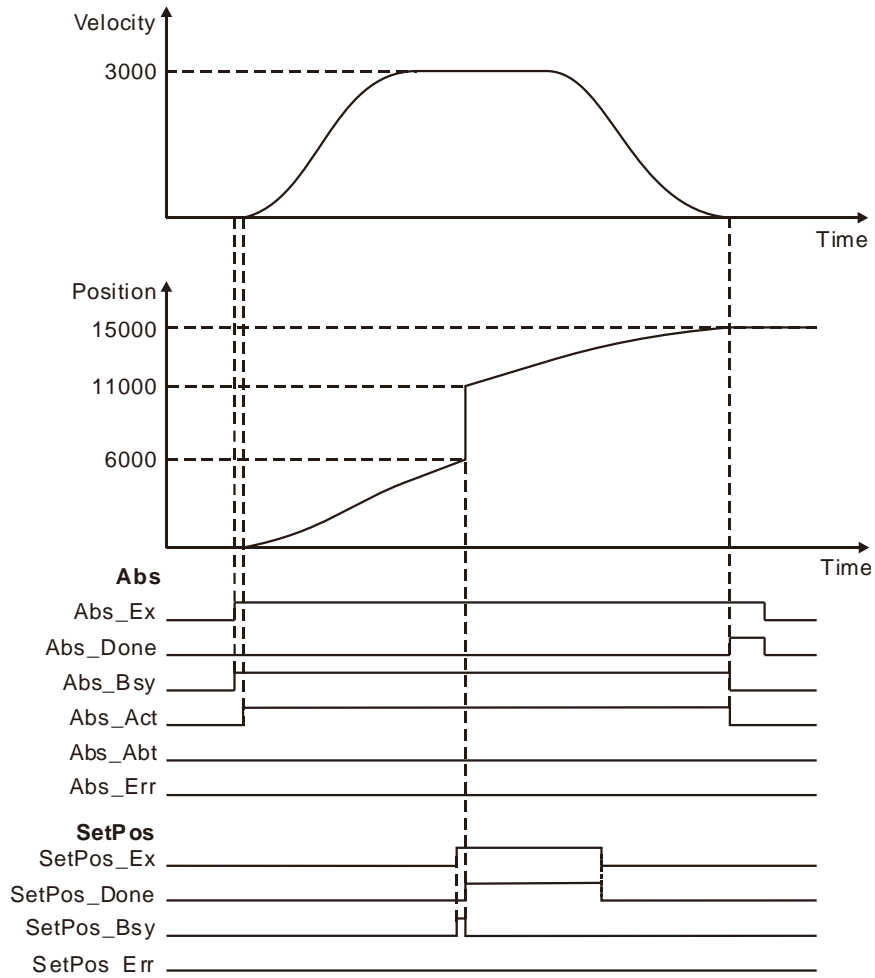

- ❖ As Abs_Ex changes from FALSE to TRUE, the execution of MC_MoveAbsolute instruction is started and MC_SetPosition is executed 3 seconds later after MC_MoveAbsolute is executed.
- ❖ The command position is 6000 as MC_SetPosition starts being executed and 11000 after the instruction execution is completed. The position is 15000 as MC_MoveAbsolute execution ends.
- ❖ It can be seen that MC_SetPosition does not affect the actual execution effect of MC_MoveAbsolute which is being executed through observing the above velocity change curve.

11.3.12 MC_SetOverride

11

FB/FC	Explanation	Applicable model
FB	MC_SetOverride changes the target velocity for an axis.	DVP15MC11T DVP15MC11T-06

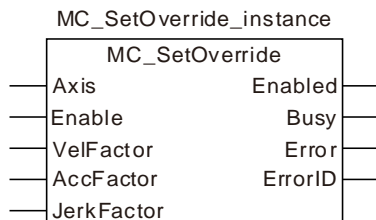

● **Input Parameters**

Parameter name	Function	Data type	Valid range (Default)	Validation timing
Axis	Specify the number of the axis which is to be controlled.	USINT	Refer to Functions of Section 2.2. (The variable value must be set)	When <i>Enable</i> changes to TRUE
Enable	The instruction is executed when <i>Enable</i> changes from FALSE to TRUE.	BOOL	TRUE or FALSE (FALSE)	-
VelFactor	Velocity override factor (Unit: %)	LREAL	0~500 (100)	When <i>Enable</i> changes to TRUE
AccFactor	Reserved	-	-	-
JerkFactor	Reserved	-	-	-

● **Output Parameters**

Parameter name	Function	Data type	Valid range
Enabled	TRUE when the instruction is controlling the axis.	BOOL	TRUE / FALSE
Busy	TRUE when the instruction is being executed.	BOOL	TRUE/FALSE
Error	TRUE when an error occurs in execution of the instruction.	BOOL	TRUE / FALSE
ErrorID	Contains the error code when an error occurs. Please refer to section 12.2 for the corresponding error ID.	WORD	-

● **Output Update Timing**

Parameter Name	Timing for changing to TRUE	Timing for changing to FALSE
Enabled	◆ When the instruction starts.	◆ When <i>Enable</i> changes to FALSE. ◆ When <i>Error</i> changes to TRUE.
Busy	◆ When <i>Enable</i> is TRUE.	◆ When <i>Enable</i> changes to FALSE. ◆ When <i>Error</i> changes to TRUE.
Error	◆ When an error occurs in the instruction execution or the input parameters for the instruction are illegal.	◆ When <i>Enable</i> changes from TRUE to FALSE

- **Output Update Timing Chart**

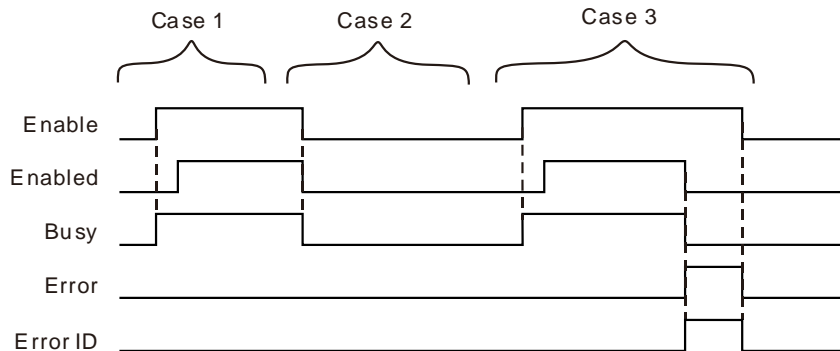

Case 1 : When *Enable* changes from FALSE to TRUE, *Busy* changes to TRUE. *Enabled* changes to TRUE when the instruction execution is completed.

Case 2 : When *Enable* changes from TRUE to FALSE, *Enabled* and *Busy* change to FALSE.

Case 3 : When an error occurs after *Enable* changes from FALSE to TRUE, *Error* changes to TRUE and *ErrorID* shows corresponding error code. Meanwhile, *Enabled* and *Busy* change to FALSE. *Error* changes to FALSE when *Enable* changes from TRUE to FALSE.

- **Function**

MC_SetOverride changes the target velocity for an axis.

1. If the target velocities of motion instructions are to be modified, use the MC_SetOverride instruction. Therefore, the instruction has no influence on the instructions without target velocities. However, *Enabled* remains TRUE even if the *Enable* of MC_SetOverride instruction is set to TRUE for the instructions which are not affected by MC_SetOverride.
2. The instructions of which the target velocities can be modified by MC_SetOverride are shown in the following table.

MC_MoveAbsolute (Absolute positioning)	MC_MoveRelative (Relative positioning)
MC_MoveAdditive (Additive positioning)	MC_MoveVelocity (Velocity instruction)
MC_MoveSuperimposed (Superimposed positioning)	

3. The new target velocity is calculated as below.
The new target velocity after modification = Target velocity of currently executed instruction x Velocity override factor
4. The unit of *VelFactor* is %. "100" indicates "100%". The valid range of *VelFactor* is between 0 and 500. An error will occur if the MC_SetOverride instruction is executed when *VelFactor* value exceeds the valid range.
5. The axis will speed up or down till the target velocity after modification is reached according to *Acceleration* or *Deceleration* of the currently executed instruction.
6. An error will occur when the target velocity after modification exceeds the maximum velocity in axis parameters.
7. If *VelFactor* value is set to 0, the target velocity changes to 0, the axis decelerates till the velocity is 0. If the axis operation state need be kept and axis operation need pause, set *VelFactor* value to 0. At the moment, the axis state will not change.
8. When motion instructions are executed or buffered, the *VelFactor* value can be modified to set the new target velocity.
9. If *VelFactor* value is modified when *Enable* is TRUE, the value will be effective immediately without restarting the MC_SetOverride instruction.

10. If *VelFactor* value is modified when *Enable* is TRUE and *VelFactor* value exceeds the valid range, an error will occur in MC_SetOverride and the target velocity will return to that as *VelFactor* value is 100%.
11. When *Enable* changes to FALSE, the axis will accelerate or decelerate by taking *VelFactor*=100 as the target.
12. If another MC_SetOverride instruction is started while one MC_SetOverride instruction is being executed on the axis, the execution result of the later executed MC_SetOverride instruction will be regarded as the reference result. The *Enabled* of the two instructions is TRUE.
13. If the MC_SetOverride instruction is used in the course of execution of the MC_MoveVelocity instruction, *InVelocity* remains TRUE even if MC_SetOverride is executed after *Invelocity* of MC_MoveVelocity changes to TRUE.



Programming Example

The example of how MC_MoveVelocity is affected by the execution of the MC_SetOverride instruction is described as below.

1. The variable table and program

Variable name	Data type	Initial value
SetOv	MC_SetOverride	
Axis1	USINT	1
SetOv_En	BOOL	FALSE
SetOv_Velt	LREAL	0.0
SetOv_Ena	BOOL	
SetOv_Bsy	BOOL	
SetOv_Err	BOOL	
SetOv_ErrID	WORD	
Vel	MC_MoveVelocity	
Vel_Ex	BOOL	FALSE
Vel_Dir	MC_DIRECTION	1
Vel_Invel	BOOL	
Vel_Bsy	BOOL	
Vel_Act	BOOL	
Vel_Abt	BOOL	
Vel_Err	BOOL	
Vel_ErrID	WORD	

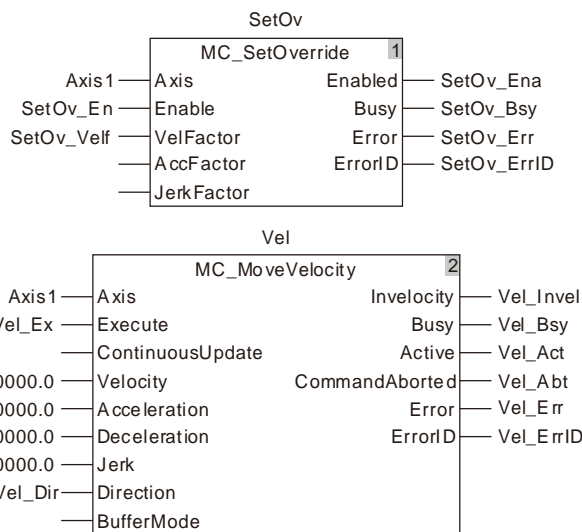

2. Motion Curve and Timing Chart

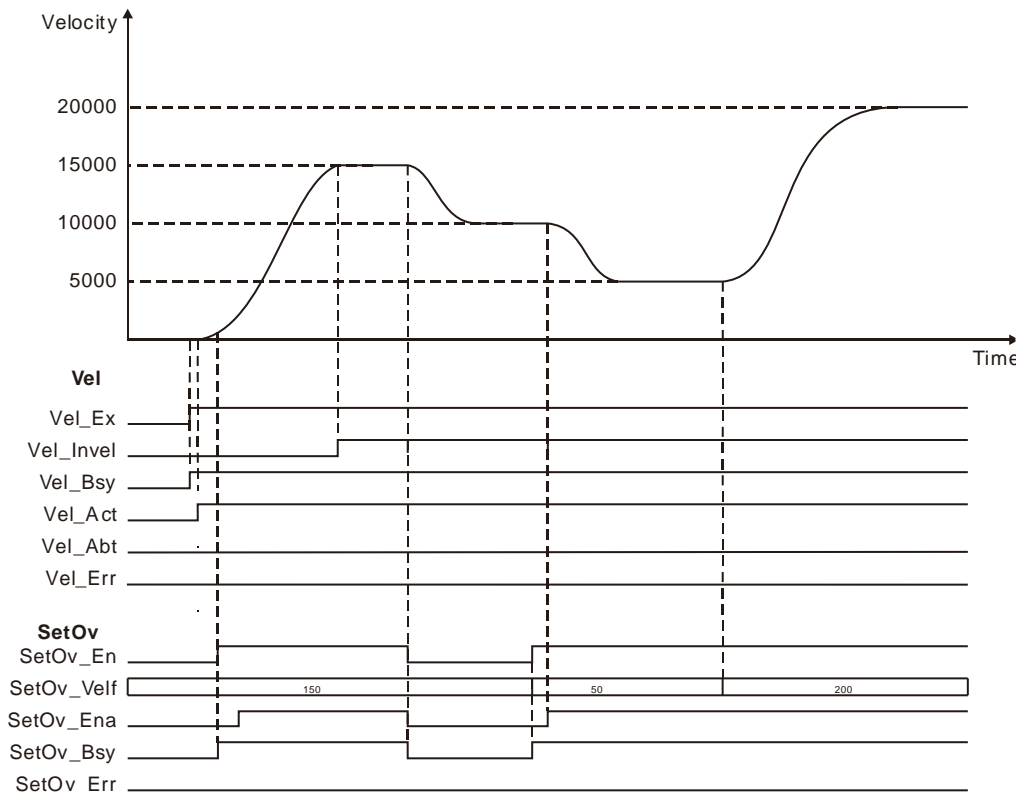

- ❖ When **Vel_Ex** changes to TRUE, **Vel_Bsy** changes to TRUE. One cycle later, **Vel_Act** changes to TRUE and the axis starts to run forward. When the target velocity is not reached (**Vel_Invel** is not TRUE), **SetOv_En** is set to TRUE, **MC_SetOverride** is effective and the target velocity of **MC_MoveVelocity** changes to the new target velocity. When the new target velocity of **MC_MoveVelocity** is reached, **Vel_Invel** changes to TRUE. After **Vel_Invel** changes to TRUE, **Vel_Invel** remains TRUE even if **VelFactor** value (**SetOv_Velf**) is modified.
- ❖ When **SetOv_En** changes to FALSE, it means the axis starts to decelerate with the velocity of when **Vel_Invel** value is 100 as the target velocity.
- ❖ **SetOv_Velf** value will come to effect immediately if **SetOv_Velf** value is modified in the course of execution of **MC_SetOverride**. And the target velocity of **MC_MoveVelocity** will change accordingly.

11.3.13 MC_Reset

FB/FC	Explanation	Applicable model
FB	MC_Reset clears the error states and axis alarm information inside the motion controller.	DVP15MC11T DVP15MC11T-06

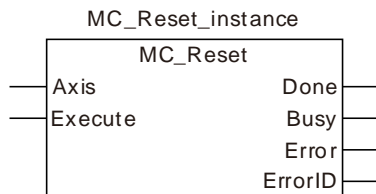

● Input Parameters

Parameter name	Function	Data type	Valid range (Default)	Validation timing
Axis	Specify the number of the axis which is to be controlled.	USINT	Refer to Functions in section 2.2. (The variable value must be set)	When <i>Execute</i> changes from FALSE to TRUE
Execute	The instruction is executed when <i>Execute</i> changes from FALSE to TRUE.	BOOL	TRUE or FALSE (FALSE)	-

● Output Parameters

Parameter name	Function	Data type	Valid range
Done	TRUE when the instruction execution is completed.	BOOL	TRUE / FALSE
Busy	TRUE when the instruction is being executed.	BOOL	TRUE / FALSE
Error	TRUE when an error occurs in execution of the instruction.	BOOL	TRUE / FALSE
ErrorID	Contains the error code when an error occurs. Please refer to section 12.2 for the corresponding error ID.	WORD	

● Output Update Timing

Parameter Name	Timing for changing to TRUE	Timing for changing to FALSE
Done	◆ When the instruction execution is completed.	◆ When <i>Execute</i> changes from TRUE to FALSE after the instruction execution is completed. ◆ <i>Done</i> changes to TRUE when the instruction execution is completed after <i>Execute</i> changes from TRUE to FALSE during the instruction execution. One cycle later, <i>Done</i> changes to FALSE.
Busy	◆ When <i>Execute</i> is TRUE.	◆ When <i>Done</i> changes to TRUE. ◆ When <i>Error</i> changes to TRUE.
Error	◆ When the input parameter values of the instruction are illegal or the mistake cannot be cleared.	◆ When <i>Execute</i> changes from TRUE to FALSE

- **Output Update Timing Chart**

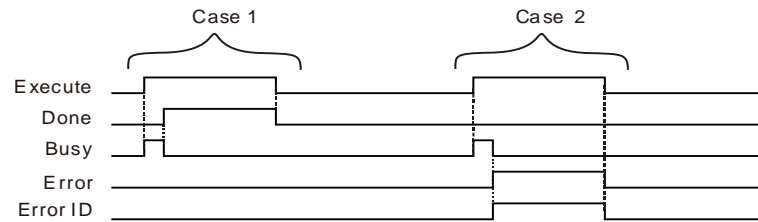

Case 1 : When *Execute* changes from FALSE to TRUE, *Busy* changes to TRUE. When the instruction execution is completed, *Done* changes to TRUE and *Busy* changes to FALSE. When *Execute* changes to FALSE, *Done* changes to FALSE.

Case 2 : When an error occurs, *Error* changes to TRUE and *ErrorID* shows corresponding error code. When *Execute* changes from TRUE to FALSE, *Error* changes to FALSE and the value of *ErrorID* is cleared to 0.

- **Function**

MC_Reset clears the error state and axis alarm information about the real axis or virtual axis inside the motion controller. The axis state can be observed via MC_ReadStatus. The MC_Reset instruction can be executed to clear the errors when the axis configured in the motion controller enters the ErrorStop state. The instruction can be executed no matter whether the axis enters the ErrorStop state or not. When the errors such as axis alarms, axis offline or state machine switch problems occur, the axis enters the ErrorStop state and the motion instructions which are being executed stop. When the axis alarms, the execution of the instruction can clear the axis alarm information. After the execution of MC_Reset instruction is completed, the axis state will be determined by MC_Power instruction and the axis will be in Disabled or Standstill state.

Refer to chapter 9 for explanation of axis states.

After the axis alarm occurs, excluding the alarm which occurs when the axis meets the limit switch in the course of homing, the alarm axis enters the ErrorStop state inside the motion controller. The axis alarm can be eliminated if *Done* is TRUE after the instruction is executed. If *Error* is TRUE, the axis alarm cannot be eliminated and users should check if the cause of the error still exists.



Programming Example

When ReadSt_En is TRUE, the MC_ReadStatus instruction will detect the status of axis 1. When axis 1 enters the ErrorStop state due to axis offline or alarm, *ErrorStop* of the MC_ReadStatus instruction will change to TRUE and the MC_Reset instruction will be executed.

1. The variable table and program

Variable name	Data type	Initial value
ReadSt	MC_ReadStatus	
Axis1	USINT	1
ReadSt_En	BOOL	FALSE
ReadSt_Vald	BOOL	
ReadSt_Bsy	BOOL	
ReadSt_Err	BOOL	
ReadSt_ErrID	WORD	
ReadSt_Disbl	BOOL	
ReadSt_Stpin	BOOL	
ReadSt_Homi	BOOL	
ReadSt_Stans	BOOL	
ReadSt_Dism	BOOL	
ReadSt_Conm	BOOL	

Variable name	Data type	Initial value
ReadSt_Sym	BOOL	
AND1_In1	BOOL	FALSE
Rset	MC_Reset	
Rset_Done	BOOL	
Rset_Bsy	BOOL	
Rset_Err	BOOL	
Rset_ErrID	WORD	

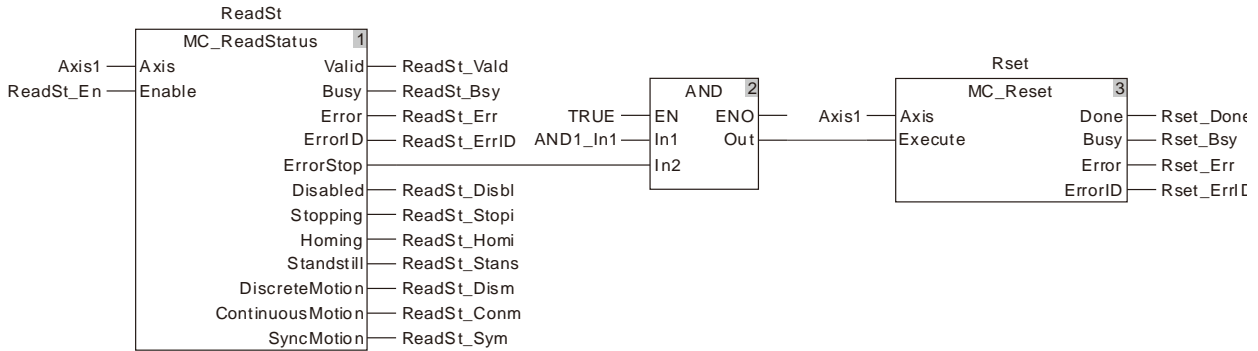

2. Timing Chart

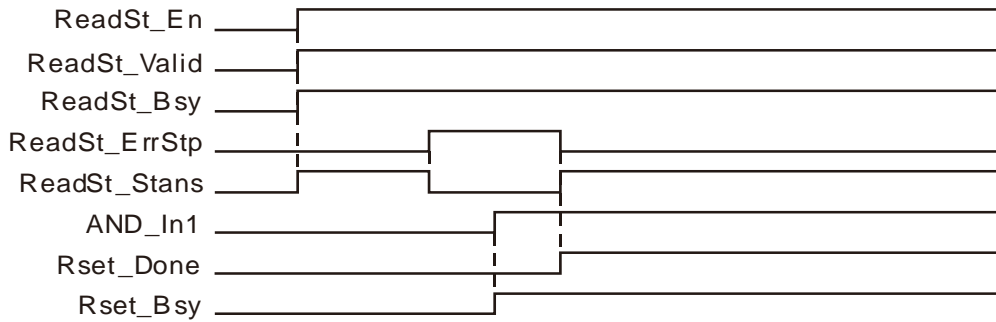

- ❖ When ReadSt_En changes from FALSE to TRUE after the servo axis is enabled, ReadSt_Valid and ReadSt_Bsy change to TRUE and the axis is in Standstill state.
- ❖ AND_In1 is set from FALSE to TRUE when the axis enters the ErrorStop state and MC_Reset is executed. Rset_Busy is TRUE in the first cycle and Rset_Done is TRUE in the second cycle. Meanwhile, the axis enters the Standstill state from the ErrorStop state.

11.3.14 DMC_SetTorque

FB/FC	Explanation	Applicable model
FB	DMC_SetTorque sets the torque of the servo axis. The servo axis will work under the torque mode when the instruction is executed.	DVP15MC11T DVP15MC11T-06

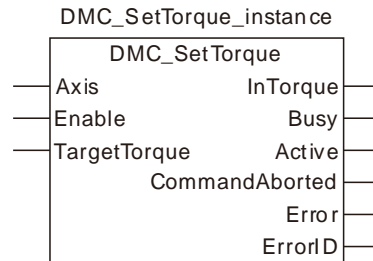

● Input Parameters

Parameter name	Function	Data type	Valid range (Default)	Validation timing
Axis	Specify the number of the axis which is to be controlled.	USINT	Refer to Functions of Section 2.2. (The variable value must be set)	When <i>Enable</i> changes to TRUE
Enable	The instruction is executed when <i>Enable</i> changes from FALSE to TRUE.	BOOL	TRUE or FALSE (FALSE)	-
TargetTorque	Specify the value of the target torque. The torque is expressed with the permillage of the rated torque of the servo axis. For example, the setting value 30 indicates that the set torque is 30% of the rated torque of the servo axis. While <i>Enable</i> is TRUE, modifying the parameter value will change the torque directly.	INT	Negative number, positive number and 0 (0)	When <i>Enable</i> changes to TRUE

Notes:

1. If the torque value is a positive number, the effect that the servo produces works in the positive direction. If the torque value is a negative number, the effect that the servo produces works in the negative direction.
2. When *Enable* is TRUE, the instruction is always valid and the torque changes accordingly as the torque value is modified. The instruction cannot be aborted by other instructions excluding MC_Stop. When *Enable* of the instruction is reset to FALSE, the instruction execution stops and other instruction can be executed.

● Output Parameters

Parameter name	Function	Data type	Valid range
InTorque	TRUE when the target torque is reached.	BOOL	TRUE / FALSE
Busy	TRUE when the instruction is being executed.	BOOL	TRUE / FALSE
Active	TRUE when the axis is being controlled.	BOOL	TRUE / FALSE
CommandAborted	TRUE when the instruction is aborted.	BOOL	TRUE / FALSE
Error	TRUE when an error occurs in execution of the instruction.	BOOL	TRUE / FALSE
ErrorID	Contains the error code when an error occurs.	WORD	

Parameter name	Function	Data type	Valid range
	Please refer to section 12.2 for the corresponding error ID.		

● **Output Update Timing**

Parameter Name	Timing for changing to TRUE	Timing for changing to FALSE
InTorque	◆ When the target torque is reached.	◆ When <i>Error</i> changes to TRUE. ◆ When <i>Enable</i> changes from TRUE to FALSE
Busy	◆ When <i>Enable</i> changes to TRUE	◆ When <i>InTorque</i> changes to TRUE. ◆ When <i>Error</i> changes to TRUE.
Active	◆ When the instruction starts to control the axis	◆ When <i>InTorque</i> changes to TRUE. ◆ When <i>Error</i> changes to TRUE.
CommandAborted	◆ When this instruction execution is aborted by other motion control instruction.	◆ When <i>Enable</i> changes from TRUE to FALSE ◆ <i>CommandAborted</i> is set to TRUE when the instruction is aborted after <i>Enable</i> changes from TRUE to FALSE during the instruction execution. One cycle later, <i>CommandAborted</i> changes to FALSE.
Error	◆ When an error occurs in the instruction execution or the input parameters for the instruction are illegal.	◆ When <i>Enable</i> changes from TRUE to FALSE

● **Output Update Timing Chart**

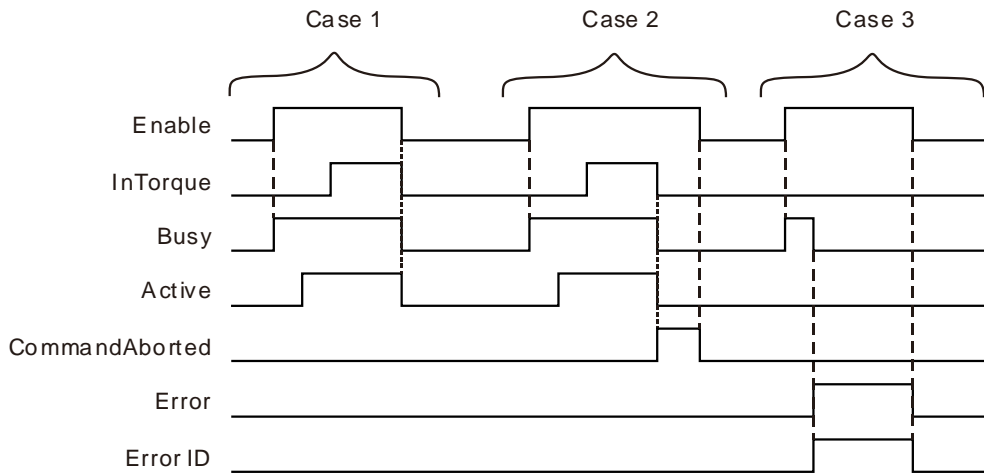

- Case 1 :** When *Enable* changes from FALSE to TRUE, *Busy* changes to TRUE in the same cycle. *Active* changes to TRUE in the next cycle and *InTorque* changes to TRUE in the 3rd cycle. When *Enable* changes from TRUE to FALSE, *Busy*, *Active* and *InTorque* change to FALSE in the same cycle.
- Case 2 :** When the DMC_SetTorque instruction is aborted by MC_Stop after *Enable* changes from FALSE to TRUE, *CommandAborted* changes to TRUE and meanwhile, *InTorque*, *Busy* and *Active* change to FALSE. When *Enable* changes from TRUE to FALSE, *CommandAborted* changes to FALSE.
- Case 3 :** The input parameter value is illegal such as the axis number: 0 before the DMC_SetTorque instruction is executed. *Busy* changes to TRUE when *Enable* changes from FALSE to TRUE. One cycle later, *Error* changes to TRUE, *Busy* changes to FALSE and *ErrorID* shows

corresponding error codes. When *Enable* changes from TRUE to FALSE, *Error* changes from TRUE to FALSE and the content of *ErrorID* is cleared to 0.

- **Function**

DMC_SetTorque sets the torque of the servo axis. The servo axis will work under the torque mode when the instruction is executed.



- **Programming Example**

The example of executing the DMC_SetTorque instruction is described as follows.

1. **The variable table and program**

Variable name	Data type	Initial value
Pwr	MC_Power	
Axis1	USINT	1
Pwr_BM	MC_Buffer_Mode	0
Pwr_Sta	BOOL	
Pwr_Bsy	BOOL	
Pwr_Act	BOOL	
Pwr_Err	BOOL	
Pwr_ErrID	WORD	
SetTq	DMC_SetTorque	
SetTq_En	BOOL	FALSE
SetTq_InTorque	BOOL	
SetTq_Bsy	BOOL	
SetTq_Act	BOOL	
SetTq_Abt	BOOL	
SetTq_Err	BOOL	
SetTq_ErrID	WORD	

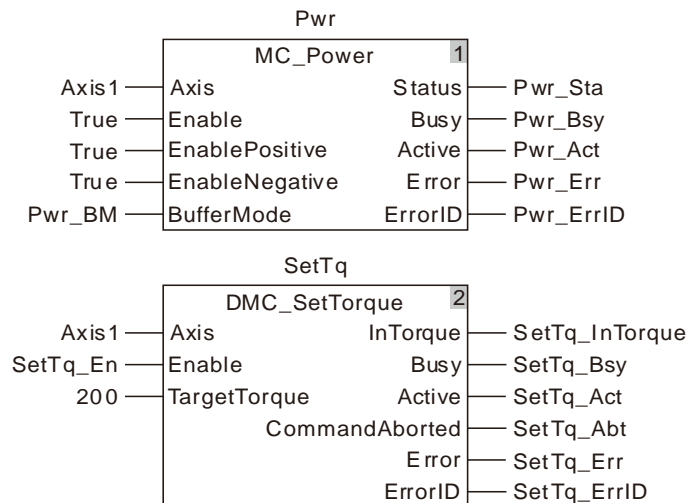

2. Motion Curve and Timing Chart

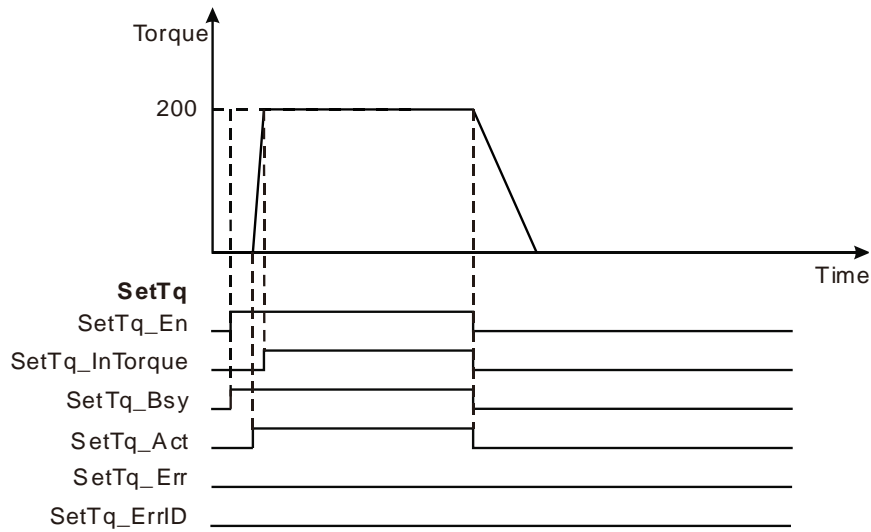

- ❖ When SetTq_En changes from FALSE to TRUE after the servo axis is enabled, SetTq_Bsy changes to TRUE. One cycle later, SetTq_Act changes to TRUE and the DMC_SetTorque instruction starts. When the torque is reached, SetTq_InTorque changes to TRUE and SetTq_Bsy and SetTq_Act remain TRUE.
- ❖ SetTq_InTorque, SetTq_Bsy and SetTq_Act change to FALSE when SetTq_En changes from FALSE to TRUE.

11.3.15 MC_ReadAxisError

FB/FC	Explanation	Applicable model
FB	MC_ReadAxisError is used to read the error information of a servo axis.	DVP15MC11T DVP15MC11T-06

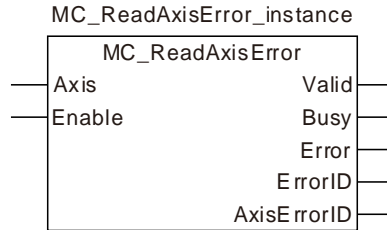

● Input Parameters

Parameter name	Function	Data type	Valid range (Default)	Validation timing
Axis	Specify the number of the axis which is to be controlled	USINT	Refer to Functions of Section 2.2. (The variable value must be set)	When <i>Enable</i> is TRUE
Enable	The instruction is executed when <i>Enable</i> changes from FALSE to TRUE.	BOOL	TRUE or FALSE (FALSE)	-

● Output Parameters

Parameter name	Function	Data type	Valid range
Valid	TRUE when the output of the instruction is valid.	BOOL	TRUE / FALSE
Busy	TRUE while the instruction is being executed.	BOOL	TRUE / FALSE
Error	TRUE while there is an error in the execution of the instruction.	BOOL	TRUE / FALSE
ErrorID	Contains the error code when an error occurs. Please refer to section 12.2.	WORD	
AxisErrorID	When <i>Valid</i> is TRUE, the value of <i>ErrorID</i> , xxx (hex) indicates that the servo drive releases an alarm and xxx is the alarm code that the servo drive reports. For example, AL303 of the servo drive means the value of <i>ErrorID</i> is 303 (hex).	WORD	

● Output Update Timing

Parameter Name	Timing for changing to TRUE	Timing for changing to FALSE
Valid	◆ When an axis error is read	◆ When <i>Enable</i> changes from TRUE to FALSE ◆ When Error changes from FALSE to TRUE
Busy	◆ When <i>Enable</i> changes to TRUE	◆ When <i>Enable</i> changes from TRUE to FALSE ◆ When Error changes from FALSE to TRUE
Error	◆ When an error occurs in the instruction execution or the input parameters for the instruction are illegal	◆ When <i>Enable</i> changes from TRUE to FALSE

● Output Update Timing Chart

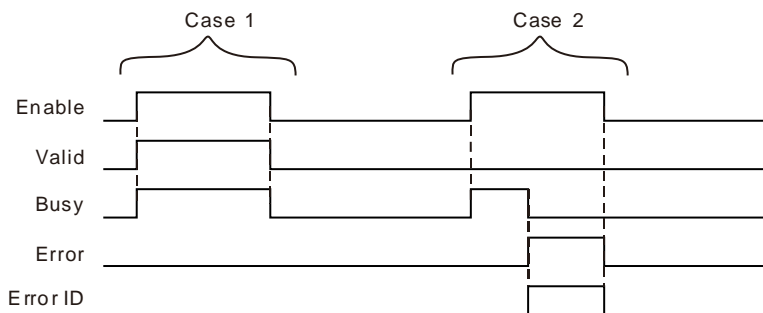

Case 1 : When *Enable* changes from FALSE to TRUE, *Valid* and *Busy* change to TRUE. When *Enable* changes to FALSE, *Valid* and *Busy* change to FALSE.

Case 2 : When an error occurs, *Error* changes to TRUE and *ErrorID* shows corresponding error code. Meanwhile *Busy* changes to FALSE. When *Enable* changes from TRUE to FALSE, *Error* changes to FALSE and the value of *ErrorID* is cleared.

- **Function**

MC_ReadAxisError is used to read error information of a servo axis such as the alarm code which will show up on the panel of the servo drive and servo axis offline. The instruction is triggered by the high level. Axis errors will be read when *Valid* is TRUE.

11.3.16 MC_ReadActualPosition

FB/FC	Explanation	Applicable model
FB	MC_ReadActualPosition is used to read the actual position of an axis including real axes, virtual axes and encoder axes.	DVP15MC11T DVP15MC11T-06

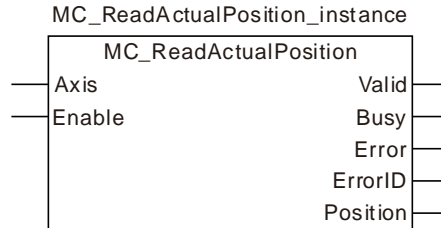

● Input Parameters

Parameter name	Function	Data type	Valid range (Default)	Validation timing
Axis	Specify the number of the axis which is to be controlled	USINT	Refer to Functions of Section 2.2. (The variable value must be set)	When <i>Enable</i> changes to TRUE
Enable	The instruction is executed when <i>Enable</i> changes to TRUE.	BOOL	TRUE or FALSE (FALSE)	-

● Output Parameters

Parameter name	Function	Data type	Valid range
Valid	TRUE when the output of the instruction is valid.	BOOL	TRUE / FALSE
Busy	TRUE while the instruction is being executed.	BOOL	TRUE / FALSE
Error	TRUE while there is an error in the execution of the instruction.	BOOL	TRUE / FALSE
ErrorID	Contains the error code when an error occurs. Please refer to section 12.2.	WORD	
Position	The actual position of the axis.	LREAL	

● Output Update Timing

Name	Timing for changing to TRUE	Timing for changing to FALSE
Valid	◆ When the actual position has been read.	◆ When <i>Enable</i> changes from TRUE to FALSE
Busy	◆ When <i>Enable</i> changes to TRUE.	◆ When Done changes to TRUE ◆ When Error changes to TRUE
Error	◆ When an error occurs in the instruction execution or the input parameters for the instruction are illegal	◆ When <i>Enable</i> changes from TRUE to FALSE

● **Output Update Timing Chart**

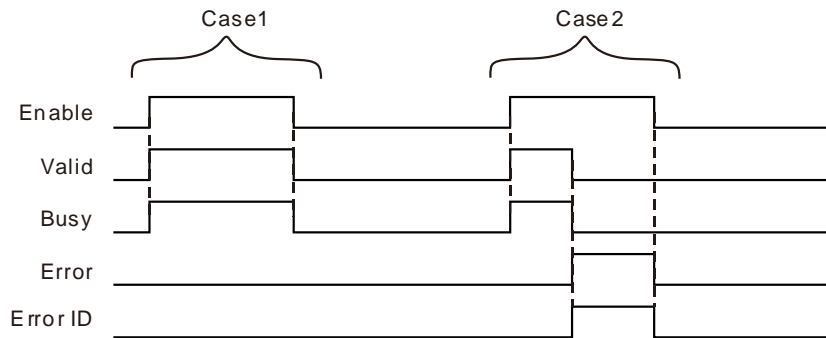

Case 1 : When *Enable* changes from FALSE to TRUE, *Valid* and *Busy* change to TRUE simultaneously. When *Enable* changes to FALSE, *Valid* and *Busy* change to FALSE.

Case 2 : As an error occurs, *Error* changes to TRUE and *ErrorID* shows the corresponding error code. Meanwhile, *Busy* and *Valid* change to FALSE. When *Enable* changes from TRUE to FALSE, *Error* changes to FALSE and the value of *ErrorID* is cleared.

● **Function**

MC_ReadActualPosition is used to read the actual position of an axis including the real axis, virtual axis and encoder axis.

■ **Actual Position**

The unit of the actual position read by MC_ReadActualPosition is Unit and the unit of the feedback position that the servo drive gives to the controller is Pulse. Thus the actual position is acquired through conversion of the number of position feedback pulses of the servo drive. The servo gear ratio, mechanical gear ratio and units per output rotation among axis parameters are needed in the conversion.

The conversion formula is shown as below.

$$\text{ActualPosition} = \frac{\text{Units per output rotation}}{(\text{the number of pulses/ rotation}) * \text{mechanical gear ratio}} * \text{The number of servo position feedback pulses}$$

If the axis is a linear axis, its output *Position* equals ActualPosition above when the instruction is executed.

If the axis is a rotary axis, its output *Position* equals ActualPosition % modulo when the instruction is executed. (*Position* is the remainder got through dividing ActualPosition by the set modulo among the axes parameters) . So the value of *Position* varies between 0 and modulo.

■ **Timing for Updating Actual Position**

The timing for updating actual position is related to the cycle time of communication between the controller and servo drive because the actual position comes from the number of feedback position pulses that the servo drive gives. In one communication cycle, the servo sends the number of feedback position pulses to the controller only once. And thus the read actual position remains unchanged within one communication cycle.

For the reasons mentioned above, please use the position capturing function to acquire the more highly real-time position since the instruction reads the less highly real-time actual position of the axis than the position capturing function does.

■ **The Impact of MC_SetPosition on Actual Position**

The actual position that MC_ReadActualPosition reads should also include the position offset caused by MC_SetPosition after MC_SetPosition is executed.

The conversion formula is shown as below.

$$\text{ActualPosition} = \text{MC_SetPosition} + \frac{\text{Units per output rotation}}{\text{(The number of pulses/rotation)} * \text{mechanical gear ratio}} * \text{The number of servo position feedback pulses}$$



Programming Example

This example shows the impact that MC_SetPosition has on the execution of MC_ReadActualPosition.

1. The variable table and program

Variable name	Data type	Initial value
Rel	MC_MoveRelative	
Axis1	USINT	1
Rel_Ex	BOOL	FALSE
Rel_Done	BOOL	
Rel_Bsy	BOOL	
Rel_Act	BOOL	
Rel_Abt	BOOL	
Rel_Err	BOOL	
Rel_ErrID	WORD	
TON1	TON	
SR1	SR	
SetPos	SetPosition	
SetPos_Ex	BOOL	FALSE
SetPos_RefTp	MC_REFERECTYPE	0
SetPos_Done	BOOL	
SetPos_Bsy	BOOL	
SetPos_Err	BOOL	
SetPos_ErrID	WORD	
ReadAtPos	ReadActualPosition	
ReadAtPos_Vald	BOOL	
ReadAtPos_Bsy	BOOL	
ReadAtPos_Err	BOOL	
ReadAtPos_ErrID	WORD	
ReadAtPos_Pst	LREAL	

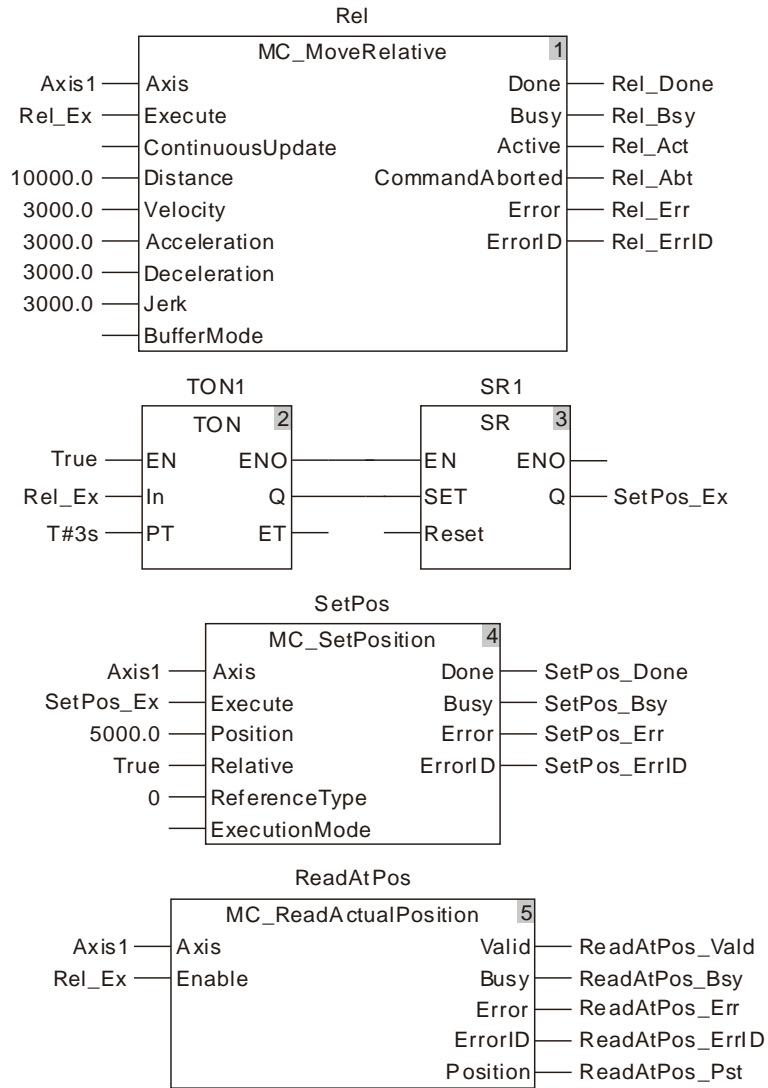

2. Motion Curve and Timing Charts:

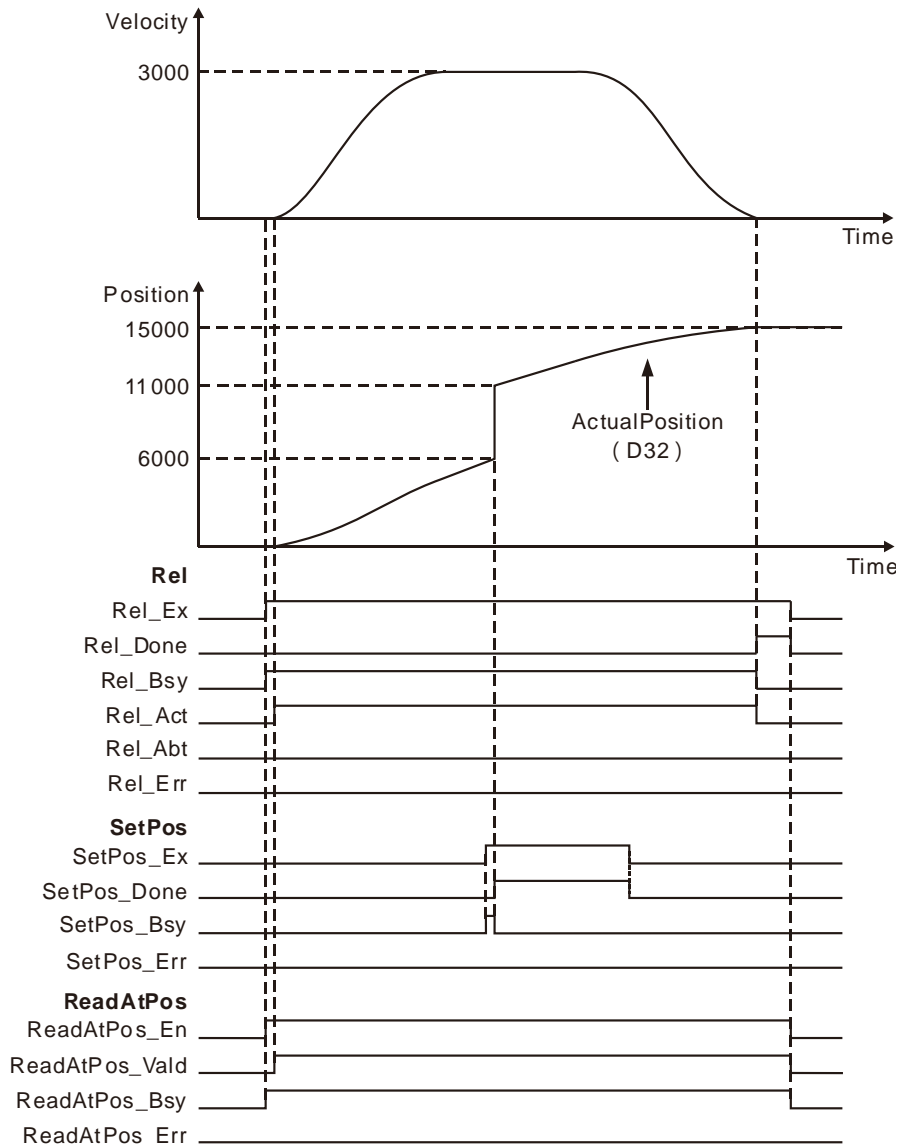

- ❖ When Rel_Ex changes from FALSE to TRUE, the execution of MC_MoveRelative and MC_ReadActualPosition is started simultaneously. MC_SetPosition is executed 3 seconds later after MC_MoveRelative is executed.
- ❖ The actual position is 6000 as MC_SetPosition starts being executed and 11000 (11000=6000+5000) after the execution is completed. The actual position is 15000 after MC_MoveRelative execution is completed.
- ❖ It can be seen from the above velocity curve chart that MC_SetPosition does not affect the ongoing motion. But the ActualPosition curve chart reflects that the actual position that MC_ReadActualPosition reads is affected by MC_SetPosition.

11.3.17 MC_ReadStatus

FB/FC	Explanation	Applicable model
FB	MC_ReadStatus is used to read the servo axis state in the controller.	DVP15MC11T DVP15MC11T-06

11

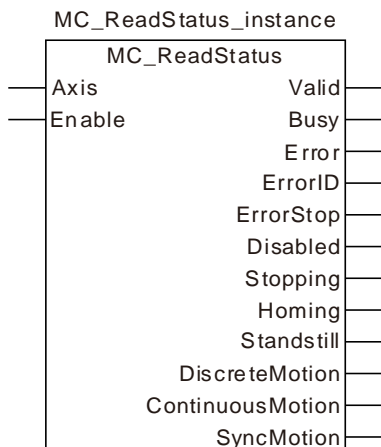

● Input Parameters

Parameter name	Function	Data type	Valid range (Default)	Validation timing
Axis	Specify the number of the axis which is to be controlled	USINT	Refer to Functions of Section 2.2. (The variable value must be set)	When Enable changes to TRUE
Enable	The instruction is executed when <i>Enable</i> changes to TRUE.	BOOL	TRUE or FALSE (FALSE)	-

● Output Parameters

Parameter name	Function	Data type	Valid range
Valid	TRUE when the output of the instruction is valid.	BOOL	TRUE / FALSE
Busy	TRUE while the instruction is being executed.	BOOL	TRUE / FALSE
Error	TRUE while there is an error in the execution of the instruction.	BOOL	TRUE / FALSE
ErrorID	Contains error codes when an error occurs. Please refer to section 12.2 for the corresponding error code.	WORD	
ErrorStop	Refer to section 10.4.	BOOL	TRUE / FALSE
Disabled		BOOL	TRUE / FALSE
Stopping		BOOL	TRUE / FALSE
Homing		BOOL	TRUE / FALSE
Standstill		BOOL	TRUE / FALSE
DiscreteMotion		BOOL	TRUE / FALSE
ContinuousMotion		BOOL	TRUE / FALSE
SyncMotion		BOOL	TRUE / FALSE

Notes:

1. When *Enable* changes from FALSE to TRUE, the execution of MC_ReadStatus starts and the axis status is read.

2. When *Enable* changes from TRUE to FALSE, *Valid*, *Busy* and *Error* change to FALSE, meanwhile *ErrorID* changes to 0 and the outputs of *ErrorStop*, *Disabled*, *Stopping*, *Homing*, *Standstill*, *DiscreteMotion*, *ContinuousMotion* and *SyncMotion* keep the status as *Enable* is TRUE.

● Output Update Timing

Name	Timing for changing to TRUE	Timing for changing to FALSE
Valid	◆ When <i>Enable</i> changes to TRUE	◆ When <i>Enable</i> changes from TRUE to FALSE ◆ When <i>Error</i> changes from FALSE to TRUE
Busy	◆ When <i>Enable</i> changes to TRUE	◆ When <i>Enable</i> changes from TRUE to FALSE ◆ When <i>Error</i> changes from FALSE to TRUE
Error	◆ When an error occurs in the instruction execution or the input parameters for the instruction are illegal	◆ When <i>Enable</i> changes from TRUE to FALSE
ErrorStop	◆ When the axis enters ErrorStop state	◆ When the axis is not in ErrorStop state
Disabled	◆ When the axis enters Disabled state	◆ When the axis is not in Disabled state
Stopping	◆ When the axis enters Stopping state	◆ When the axis is not in Stopping state
Homing	◆ When the axis enters Homing state	◆ When the axis is not in Homing state
Standstill	◆ When the axis enters Standstill state	◆ When the axis is not in Standstill
DiscreteMotion	◆ When the axis enters DiscreteMotion state	◆ When the axis is not in DiscreteMotion state
ContinuousMotion	◆ When the axis enters ContinuousMotion state	◆ When the axis is not in ContinuousMotion state
SyncMotion	◆ When the axis enters SyncMotion state	◆ When the axis is not in SyncMotion state

● Output Update Timing Chart

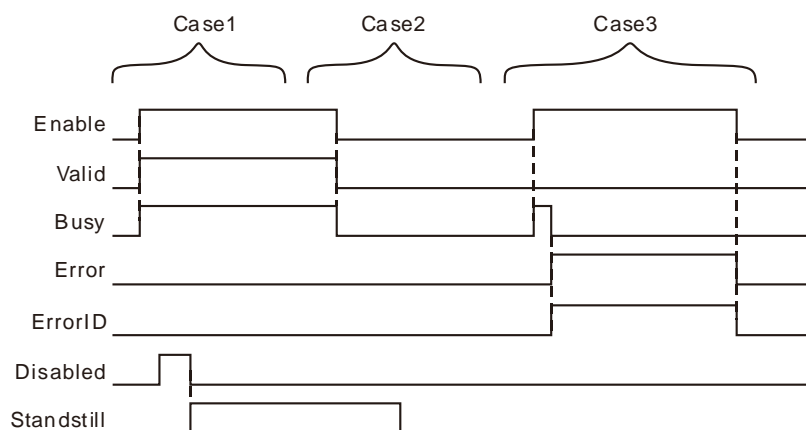

Case 1 : When *Enable* changes from FALSE to TRUE, *Valid* and *Busy* change to TRUE simultaneously and *ErrorStop*, *Disabled*, *Stopping*, *Homing*, *Standstill*, *DiscreteMotion*, *ContinuousMotion* and *SyncMotion* will change to TRUE or FALSE according to the axis status.

Case 2 : When *Enable* changes from TRUE to FALSE, *Valid* and *Busy* change to FALSE simultaneously and the outputs of *ErrorStop*, *Disabled*, *Stopping*, *Homing*, *Standstill*, *DiscreteMotion*, *ContinuousMotion* and *SyncMotion* will keep the same state as *Enable* is TRUE.

Case 3 : When the value of the input parameter *Axis* is out of the valid range and *Enable* changes from FALSE to TRUE, *Busy* changes from FALSE to TRUE, one cycle later, *Error* changes from FALSE to TRUE and *ErrorID* shows corresponding error codes and *Busy* changes from TRUE to FALSE. When *Enable* changes from TRUE to FALSE, *Error* changes from TRUE to FALSE and meanwhile *ErrorID* changes to 0.

● Function

MC_ReadStatus is used to read the servo axis state in the controller. For the details on axis states, please refer to section 10.4.



Programming Example

This example of the execution of MC_ReadStatus is shown as below.

1. The variable table and program

Variable name	Data type	Initial value
Pwr	MC_Power	
Axis1	USINT	1
Pwr_En	BOOL	FALSE
Pwr_BM	MC_Buffer_Mode	0
Pwr_Sta	BOOL	
Pwr_Bsy	BOOL	
Pwr_Act	BOOL	
Pwr_Err	BOOL	
Pwr_ErrID	WORD	
Rel	MC_MoveRelative	
Rel_Ex	BOOL	FALSE
Rel_BM	MC_Buffer_Mode	0
Rel_Done	BOOL	
Rel_Bsy	BOOL	
Rel_Act	BOOL	
Rel_Abt	BOOL	
Rel_Err	BOOL	
Rel_ErrID	WORD	
ReadSt	MC_ReadStatus	
ReadSt_En	BOOL	FALSE
ReadSt_Vald	BOOL	
ReadSt_Bsy	BOOL	
ReadSt_Err	BOOL	
ReadSt_ErrID	WORD	
ReadSt_ErrStp	BOOL	
ReadSt_Disbl	BOOL	
ReadSt_Stpin	BOOL	

Variable name	Data type	Initial value
ReadSt_Homi	BOOL	
ReadSt_Stans	BOOL	
ReadSt_Dism	BOOL	
ReadSt_Conm	BOOL	
ReadSt_Sym	BOOL	

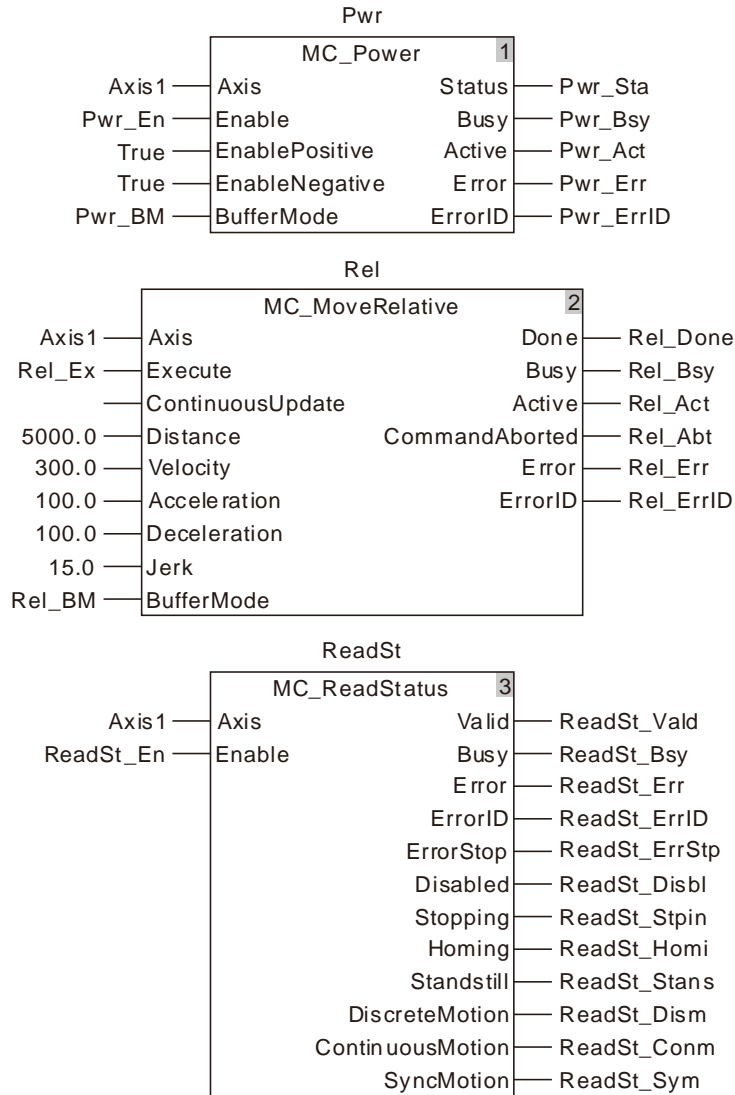

2. Motion Curve and Timing Charts:

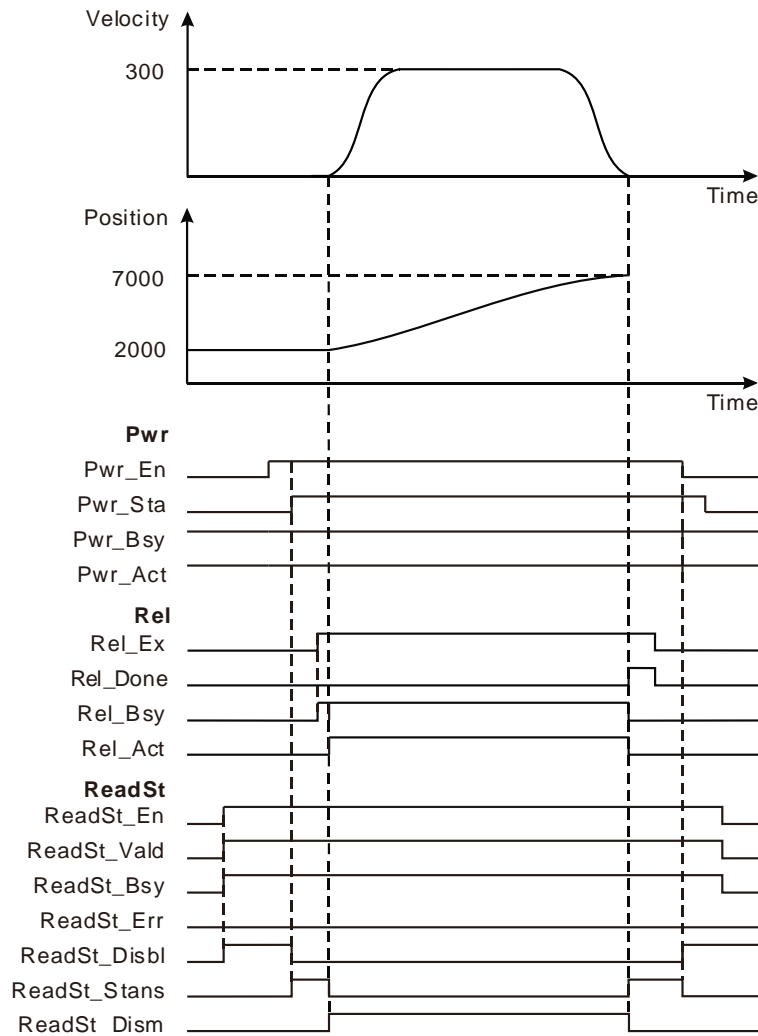

- ❖ ReadSt_Vald, ReadSt_Bsy and ReadSt_Disbl change to TRUE as ReadSt_En changes from FALSE to TRUE.
- ❖ When Pwr_Sta changes from FALSE to TRUE, ReadSt_Stans changes to TRUE, ReadSt_Disbl changes to FALSE and the state of the axis changes from Disabled to Standstill.
- ❖ The motion controller controls the servo motor to move by starting from current position as Rel_Act changes from FALSE to TRUE. Meanwhile ReadSt_Stans changes to FALSE and ReadSt_Dism changes to TRUE. When the servo motor moves the target distance, Rel_Done and ReadSt_Stans change to TRUE; Rel_Bsy, Rel_Act and ReadSt_Dism change to FALSE.
- ❖ Rel_Done also changes to FALSE as Rel_Ex changes to FALSE.
- ❖ When Pwr_En changes to FALSE, ReadSt_Disbl changes to TRUE, ReadSt_Stans changes to FALSE and several cycles later Pwr_Sta also changes to FALSE.
- ❖ When ReadSt_En changes to FALSE, ReadSt_Vald and ReadSt_Bsy change to FALSE and ReadSt_Disbl remains TRUE.

11.3.18 MC_ReadMotionState

FB/FC	Explanation	Applicable model
FB	MC_ReadMotionState is used to read current motion state of the servo axis.	DVP15MC11T DVP15MC11T-06

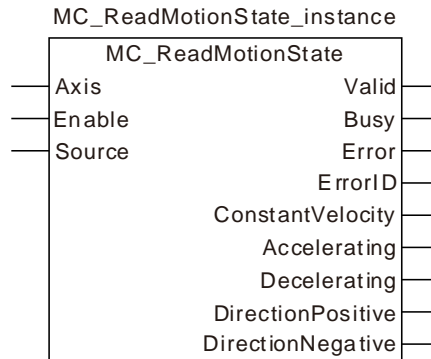

● Input Parameters

Parameter name	Function	Data type	Valid range (Default)	Validation timing
Axis	Specify the number of the axis which is to be controlled	USINT	Refer to Functions of Section 2.2. (The variable value must be set)	When <i>Enable</i> changes to TRUE
Enable	The instruction is executed when <i>Enable</i> changes to TRUE.	BOOL	TRUE or FALSE (FALSE)	-
Source	Reserved	-	-	-

Notes:

1. When *Enable* changes from FALSE to TRUE, the execution of MC_ReadStatus starts.
2. When MC_ReadStatus is being executed and *Enable* changes from TRUE to FALSE, the instruction execution stops and the outputs of *ConstantVelocity*, *Accelerating*, *Decelerating*, *DirectionPositive* and *DirectionNegative* keep the status as *Enable* is TRUE.

● Output Parameters

Parameter name	Function	Data type	Valid range
Valid	TRUE when the output of the instruction is valid.	BOOL	TRUE / FALSE
Busy	TRUE while the instruction is being executed.	BOOL	TRUE / FALSE
Error	TRUE while there is an error in the execution of the instruction.	BOOL	TRUE / FALSE
ErrorID	Contains error codes when an error occurs. Please refer to section 12.2 for the corresponding error code.	WORD	
ConstantVelocity	TRUE when the axis moves at a constant speed	BOOL	TRUE / FALSE
Accelerating	TRUE when the absolute value of the axis velocity is increased.	BOOL	TRUE / FALSE
Decelerating	TRUE when the absolute value of the axis velocity is decreased.	BOOL	TRUE / FALSE
DirectionPositive	TRUE when the current position value is increased.	BOOL	TRUE / FALSE
DirectionNegative	TRUE when the current position value is decreased.	BOOL	TRUE / FALSE

● Output Update Timing

Name	Timing for changing to TRUE	Timing for changing to FALSE
Valid	◆ When the actual velocity of the axis is read	◆ When <i>Enable</i> changes from TRUE to FALSE ◆ When <i>Error</i> changes from FALSE to TRUE
Busy	◆ When <i>Enable</i> changes to TRUE	◆ When <i>Enable</i> changes from TRUE to FALSE ◆ When <i>Error</i> changes from FALSE to TRUE
Error	◆ When an error occurs in the instruction execution or the input parameters for the instruction are illegal	◆ When <i>Enable</i> changes from TRUE to FALSE
ErrorID		
ConstantVelocity	◆ When the axis velocity is not changed	◆ When the axis velocity is changed and <i>Enable</i> is still TRUE
Accelerating	◆ When the absolute value of the axis velocity is increased	◆ When the axis velocity is not increased any more and <i>Enable</i> is still TRUE
Decelerating	◆ When the absolute value of the axis velocity is decreased	◆ When the axis velocity is not decreased any more and <i>Enable</i> is still TRUE
DirectionPositive	◆ When the current position value is increased	◆ When the current position value is not increased any more and <i>Enable</i> is still TRUE
DirectionNegative	◆ When the current position value is decreased	◆ When the current position value is not decreased any more and <i>Enable</i> is still TRUE

● Output Update Timing Chart

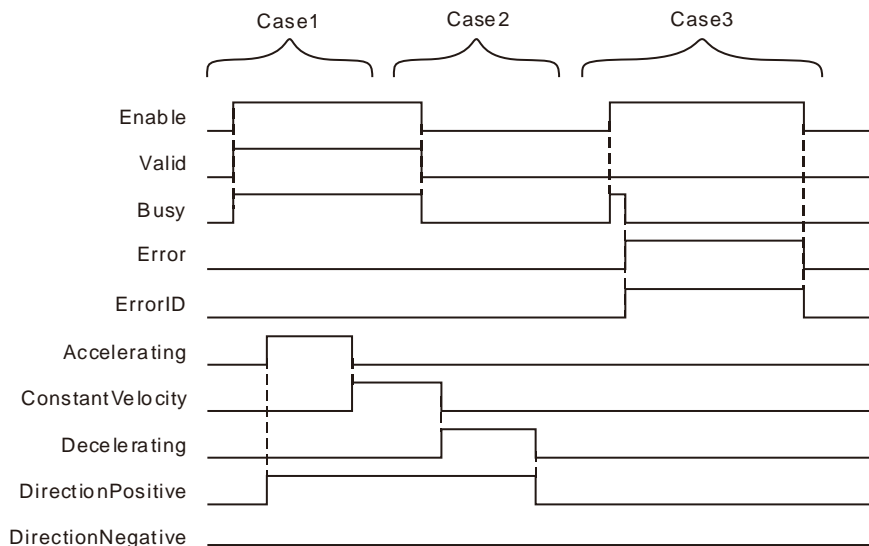

Case 1 : When *Enable* changes from FALSE to TRUE, *Valid* and *Busy* change to TRUE and *ConstantVelocity*, *Accelerating*, *Decelerating*, *DirectionPositive* and *DirectionNegative* change to TRUE or FALSE according to the axis state.

Case 2 : When *Enable* changes from TRUE to FALSE, *Valid* and *Busy* change to FALSE and *ConstantVelocity*, *Accelerating*, *Decelerating*, *DirectionPositive* and *DirectionNegative* remain the state for when *Enable* is TRUE.

Case 3 : When the value of *Axis* is out of the valid range and *Enable* changes from FALSE to TRUE, *Busy* changes from FALSE to TRUE, one period later, *Error* changes from FALSE to TRUE and *ErrorID* shows corresponding error codes. Meanwhile, *Busy* changes from TRUE to FALSE. *Error* changes from TRUE to FALSE and the value of *ErrorID* becomes 0 as *Enable* changes from TRUE to FALSE.

- **Function**

MC_ReadMotionState is used to read current motion state of the servo axis. The motion state of the servo axis includes the constant motion, acceleration or deceleration, positive rotation and negative rotation.



Programming Example

This example of the execution of MC_ReadMotionState is shown as below.

1. The variable table and program

Variable name	Data type	Initial value
Pwr	MC_Power	
Axis1	USINT	1
Pwr_En	BOOL	FALSE
Pwr_Sta	BOOL	
Pwr_Bsy	BOOL	
Pwr_Act	BOOL	
Pwr_Err	BOOL	
Pwr_ErrID	WORD	
Rel1	MC_MoveRelative	
Rel1_Ex	BOOL	FALSE
Rel1_Done	BOOL	
Rel1_Bsy	BOOL	
Rel1_Act	BOOL	
Rel1_Abt	BOOL	
Rel1_Err	BOOL	
Rel1_ErrID	WORD	
Rel2	MC_MoveRelative	
Rel2_Ex	BOOL	FALSE
Rel2_Done	BOOL	
Rel2_Bsy	BOOL	
Rel2_Act	BOOL	
Rel2_Abt	BOOL	
Rel2_Err	BOOL	
Rel2_ErrID	WORD	
ReadMoSt	MC_ReadMotionState	
ReadMoSt_En	BOOL	FALSE
ReadMoSt_Vald	BOOL	
ReadMoSt_Bsy	BOOL	
ReadMoSt_Err	BOOL	

Variable name	Data type	Initial value
ReadMoSt_ErrID	WORD	
ReadMoSt_ConstVel	BOOL	
ReadMoSt_Accet	BOOL	
ReadMoSt_Decet	BOOL	
ReadMoSt_DirtPos	BOOL	
ReadMoSt_DirtNg	BOOL	

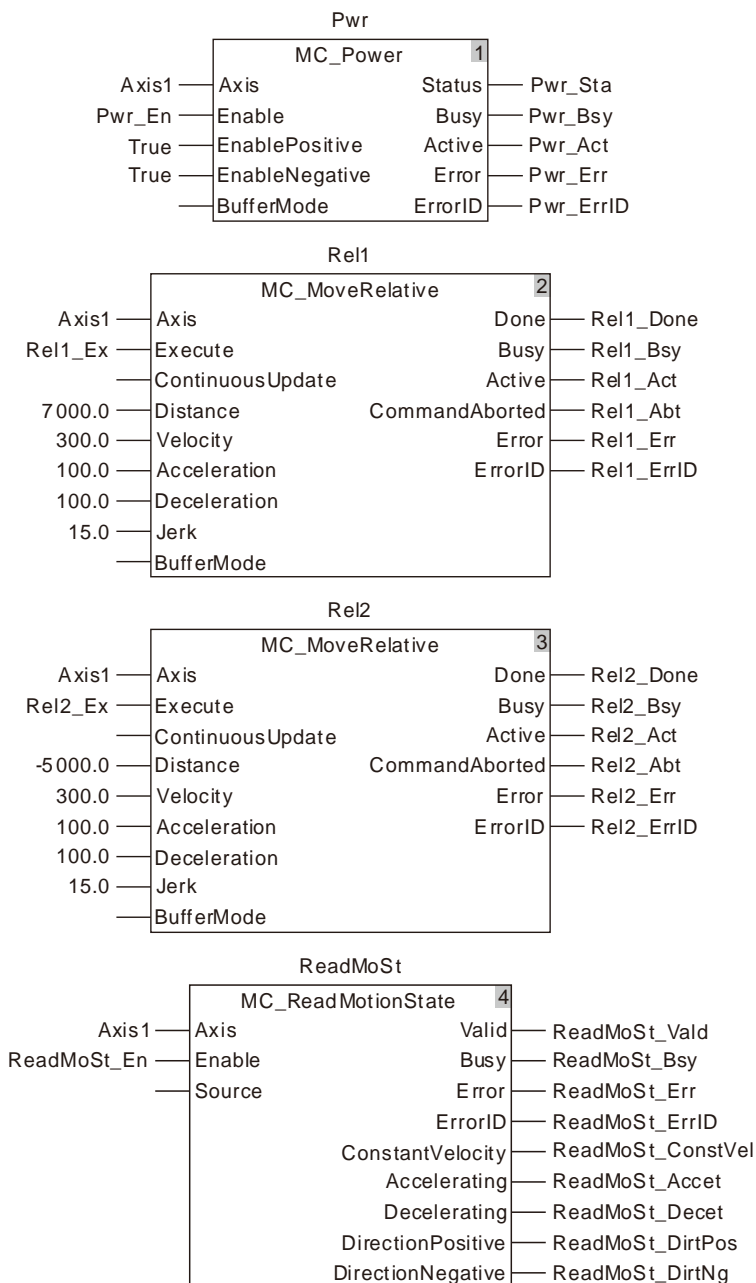

2. Motion Curve and Timing Charts:

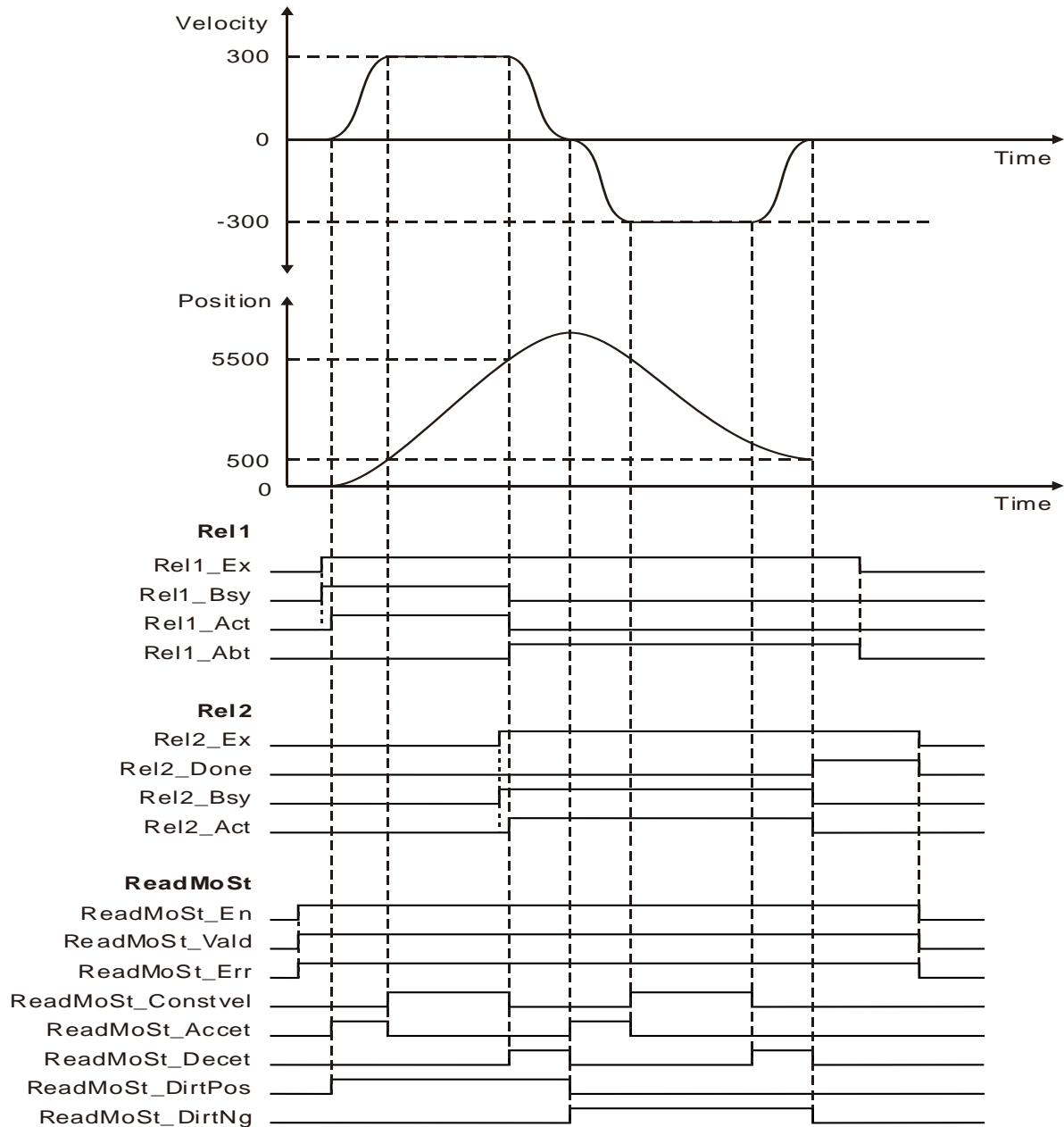

- ❖ ReadMoSt_Vald and ReadMoSt_Bsy change from FALSE to TRUE as ReadMoSt_En changes from FALSE to TRUE.
- ❖ When Rel1_Act changes from FALSE to TRUE, the axis starts accelerating in the positive direction and meanwhile, ReadMoSt_Accet and ReadMoSt_DirtPos change to TRUE.
- ❖ When ReadMoSt_Constvel changes from FALSE to TRUE, ReadMoSt_Accet changes from TRUE to FALSE and the axis enters the state of moving at a constant velocity in the positive direction.
- ❖ When Rel2_Act changes from FALSE to TRUE, ReadMoSt_Decet changes from FALSE to TRUE and the axis starts decelerating in the positive direction.
- ❖ When ReadMoSt_Accet and ReadMoSt_DirtNg change from FALSE to TRUE, ReadMoSt_Decet and ReadMoSt_DirtPos change to FALSE simultaneously and the axis starts accelerating in the negative direction.
- ❖ When Rel2_Done changes from FALSE to TRUE, the axis stops moving and both of ReadMoSt_Decet and ReadMoSt_DirtNg change to FALSE.

11.3.19 DMC_ReadParameter_Motion

FB/FC	Explanation	Applicable model
FB	DMC_ReadParameter_Motion reads a slave parameter value.	DVP15MC11T DVP15MC11T-06

11

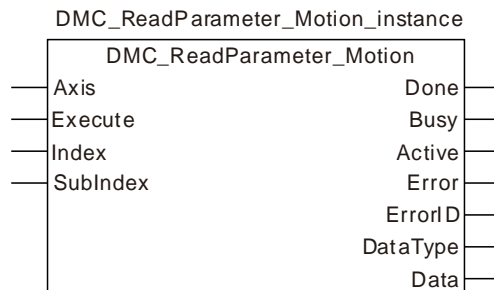

● **Input Parameters**

Parameter name	Function	Data type	Valid range (Default)	Validation timing
Axis	Specify the station address of the slave to control.	USINT	Refer to Functions of Section 2.2. (The variable value must be set)	When <i>Execute</i> changes from FALSE to TRUE
Execute	The instruction is executed when <i>Execute</i> changes from FALSE to TRUE.	BOOL	TRUE or FALSE (FALSE)	
Index	Index of the parameter to read	UINT	0	When <i>Execute</i> changes from FALSE to TRUE
SubIndex	Subindex of the parameter to read	USINT	0	When <i>Execute</i> changes from FALSE to TRUE

● **Output Parameters**

Parameter name	Function	Data type	Valid range
Done	TRUE when the instruction execution is completed.	BOOL	TRUE / FALSE
Busy	TRUE when the instruction is being executed.	BOOL	TRUE / FALSE
Active	TRUE when the axis is being controlled.	BOOL	TRUE / FALSE
Error	TRUE when an error occurs in execution of the instruction.	BOOL	TRUE / FALSE
ErrorID	Contains the error code when an error occurs. Please refer to section 12.2 for the corresponding error ID.	WORD	
DataType	The data type of the read parameter 1 : Byte, 2 : Word, 4 : Double Word.	USINT	
Data	The read parameter value	UDINT	

Note: The corresponding index and subindex of a slave parameter

1. User-defined parameter is the servo drive parameter which is to be read. The length is specified by users according to the data type of the parameter to read. The length of the byte parameter is 1. The length of the word parameter is 2. The length of the double-word parameter is 4. The calculation of the index and subindex of a servo parameter is shown as follows.

Index = Servo drive parameter (Hex) + 2000 (Hex)
 Subindex = 0.

Example: Calculation of the index of the servo parameter P6-10: 2000 + 060A (the hex. expression of P6-10) = 260A, subindex = 0.

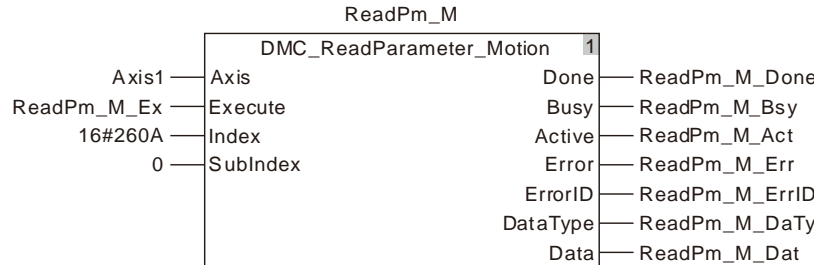

2. For the index and subindex of other slave parameters, refer to the product manual related to CANopen function.

● **Output Update Timing**

Parameter Name	Timing for changing to TRUE	Timing for changing to FALSE
Done	◆ When the reading is completed.	◆ When <i>Execute</i> changes from TRUE to FALSE after the instruction execution is completed.
Busy	◆ When <i>Execute</i> changes to TRUE.	◆ When <i>Error</i> changes to TRUE. ◆ When <i>Done</i> changes from FALSE to TRUE.
Active	◆ When the instruction starts to control the axis.	◆ When <i>Error</i> changes to TRUE. ◆ When <i>Done</i> changes from FALSE to TRUE.
Error	◆ When an error occurs in the instruction execution or the input parameters for the instruction are illegal.	◆ When <i>Execute</i> changes from TRUE to FALSE.

● **Output Update Timing Chart**

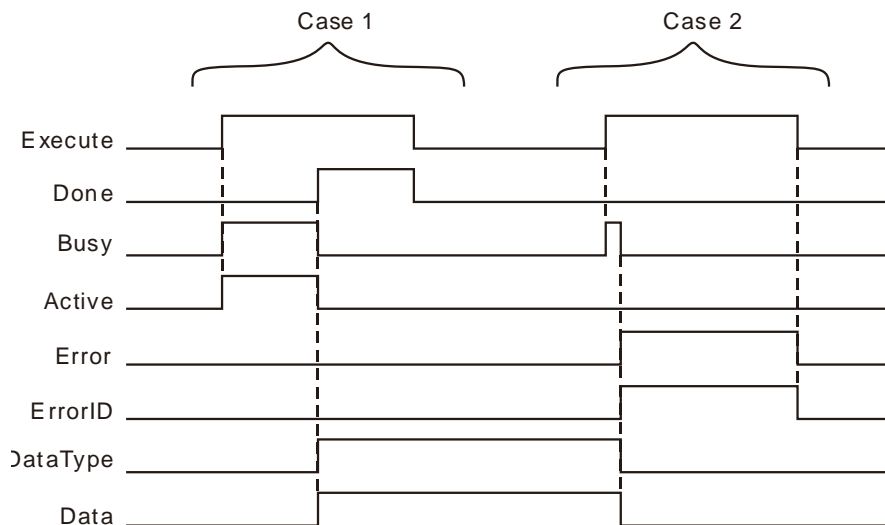

Case 1 : When *Execute* changes from FALSE to TRUE, *Busy* and *Active* change to TRUE. One cycle later, *Done* changes to TRUE and *DataType* and *Data* show corresponding data values. After *Done* changes to TRUE, *Busy* and *Active* change to FALSE in the same cycle. When *Execute* changes from TRUE to FALSE, *Done* changes from TRUE to FALSE and *DataType* and *Data* retain original values. If *Error* changes to TRUE, the values of *DataType* and *Data* will be cleared to 0.

Case 2 : The input parameter value is illegal such as axis number: 0 before the DMC_ReadParameter_Motion instruction is executed. When *Execute* changes from FALSE to TRUE, *Error* changes to from FALSE to TRUE and *ErrorID* shows corresponding error code. When *Execute* changes from TRUE to FALSE, *Error* changes from TRUE to FALSE and the content of *ErrorID* is cleared to 0.

● **Function**

DMC_ReadParameter_Motion reads a slave parameter value. Users can specify the index and subindex of the parameter which is to be read.



Programming Example

The example of executing the DMC_ReadParameter_Motion instruction is described as follows.

1. The variable table and program

Variable name	Data type	Initial value
ReadPm_M1	DMC_ReadParameter_Motion	
Axis1	USINT	1
ReadPm_M1_Ex	BOOL	TRUE
ReadPm_M1_Done	BOOL	TRUE
ReadPm_M1_Bsy	BOOL	FALSE
ReadPm_M1_Act	BOOL	FALSE
ReadPm_M1_Err	BOOL	FALSE
ReadPm_M1_ErrID	WORD	FALSE
ReadPm_M1_DaTy	USINT	2
ReadPm_M1_Dat	UDINT	5000
WritePm_M	DMC_WriteParameter_Motion	
WritePm_M_Done	BOOL	TRUE
WritePm_M_Bsy	BOOL	FALSE
WritePm_M_Act	BOOL	FALSE
WritePm_M_Err	BOOL	FALSE
WritePm_M_ErrID	WORD	FALSE
ReadPm_M2	DMC_ReadParameter_Motion	
ReadPm_M2_Done	BOOL	TRUE
ReadPm_M2_Bsy	BOOL	FALSE
ReadPm_M2_Act	BOOL	FALSE
ReadPm_M2_Err	BOOL	FALSE
ReadPm_M2_ErrID	WORD	FALSE
ReadPm_M2_DaTy	USINT	2
ReadPm_M2_Dat	UDINT	1000

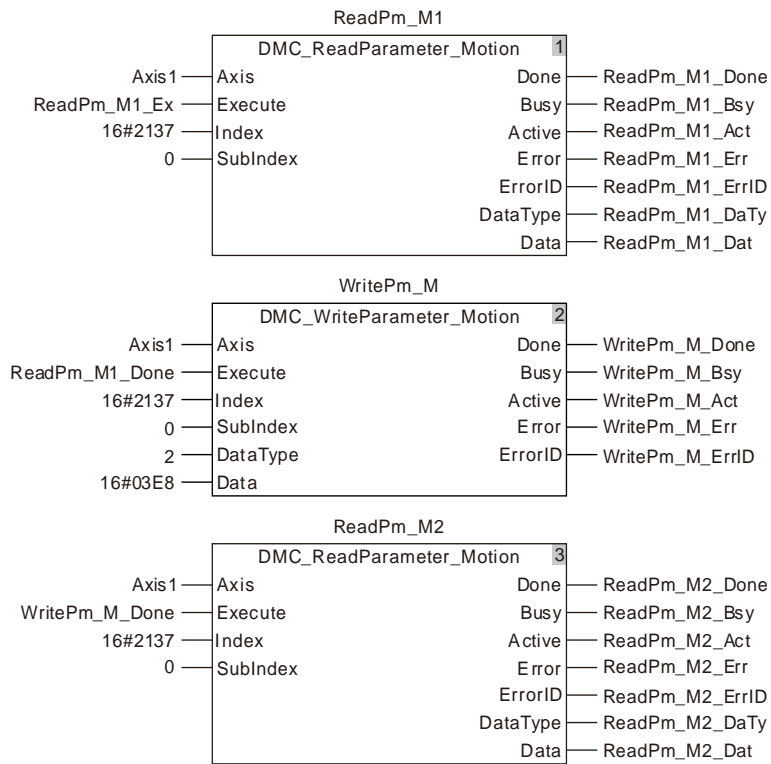

2. Timing Chart

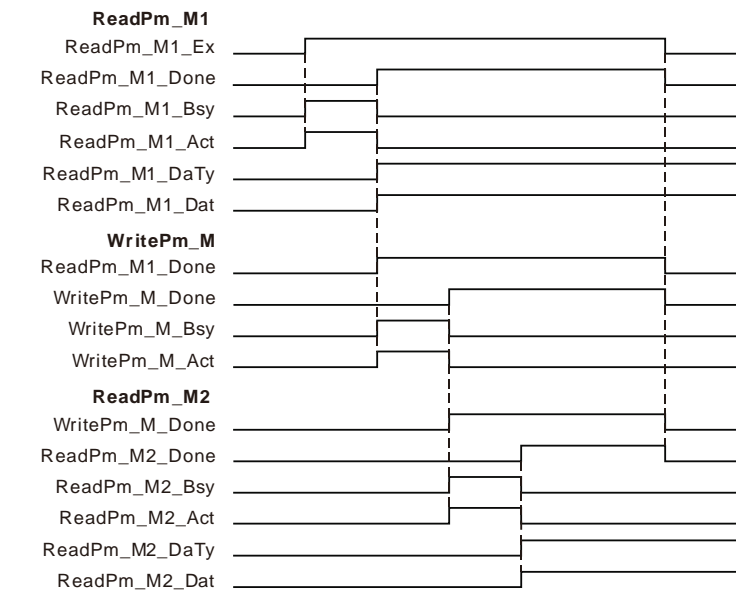

- ❖ When ReadPm_M1_Ex changes from FALSE to TRUE, executing the first DMC_ReadParameter_Motion instruction starts. When the instruction execution is completed, ReadPm_M1_Done changes to TRUE, the value of ReadPm_M1_DaTy is 2 and ReadPm_M1_Dat is 5000. That is, the content of the servo parameter P1-55 which is read is 5000 (The maximum velocity of the servo is limited to 5000rpm.)
- ❖ When ReadPm_M1_Done changes from FALSE to TRUE, executing the DMC_WriteParameter_Motion instruction starts. When the instruction execution is completed, WritePm_M_Done changes to TRUE. That means writing 1000 to the servo slave parameter P1-55 is successful. (The maximum velocity of the servo is limited to 1000rpm)

- ❖ When WritePm_M_Done changes from FALSE to TRUE, executing the second DMC_ReadParameter_Motion instruction starts. When the instruction execution is completed, ReadPm_M2_Done changes to TRUE, ReadPm_M2_DaTy is 2 and ReadPm_M2_Dat is 1000. That is, the content of the servo slave parameter P1-55 which is read is 1000. (The maximum velocity of the servo is limited to 1000rpm.)

11.3.20 DMC_WriteParameter_Motion

FB/FC	Explanation	Applicable model
FB	DMC_WriteParameter_Motion sets a slave parameter value.	DVP15MC11T DVP15MC11T-06

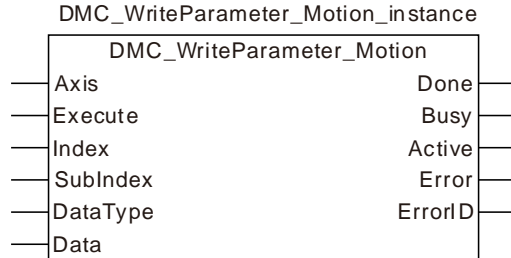

● Input Parameters

Parameter name	Function	Data type	Valid range (Default)	Validation timing
Axis	Specify the slave to control.	USINT	Refer to Functions of Section 2.2. (The variable value must be set)	When <i>Execute</i> changes from FALSE to TRUE
Execute	The instruction is executed when <i>Execute</i> changes from FALSE to TRUE.	BOOL	TRUE or FALSE (FALSE)	-
Index	The index of the parameter to write.	UINT		
SubIndex	The subindex of the parameter to write.	USINT		
DataType	The data type of the parameter to write 1 : Byte, 2 : Word, 4 : Double Word.	USINT		
Data	The value of the parameter to write	UDINT		

Notes:

1. DataType must be the data type of the parameter to write. An error will occur if the filled value is incorrect.
2. Refer to Chapter 9 for the calculation of the index and subindex of servo parameters.

● Output Parameters

Parameter name	Function	Data type	Valid range
Done	TRUE when the instruction execution is completed.	BOOL	TRUE / FALSE
Busy	TRUE when the instruction is being executed.	BOOL	TRUE / FALSE
Active	TRUE when the axis is being controlled.	BOOL	TRUE / FALSE
Error	TRUE when there is an error in the execution of the instruction.	BOOL	TRUE / FALSE
ErrorID	Contains the error code when an error occurs. Please refer to section 12.2.	WORD	

● Output Update Timing

Parameter Name	Timing for changing to TRUE	Timing for changing to FALSE
Done	◆ When the writing is completed.	◆ When <i>Execute</i> changes from TRUE to FALSE after the instruction execution is completed.
Busy	◆ When <i>Execute</i> changes to TRUE.	◆ When <i>Error</i> changes to TRUE. ◆ When <i>Done</i> changes from FALSE to TRUE.
Active	◆ When the instruction starts to control the axis.	◆ When <i>Error</i> changes to TRUE. ◆ When <i>Done</i> changes from FALSE to TRUE.
Error	◆ When an error occurs in the instruction execution or the input parameters for the instruction are illegal.	◆ When <i>Execute</i> changes from TRUE to FALSE.

● Output Update Timing Chart

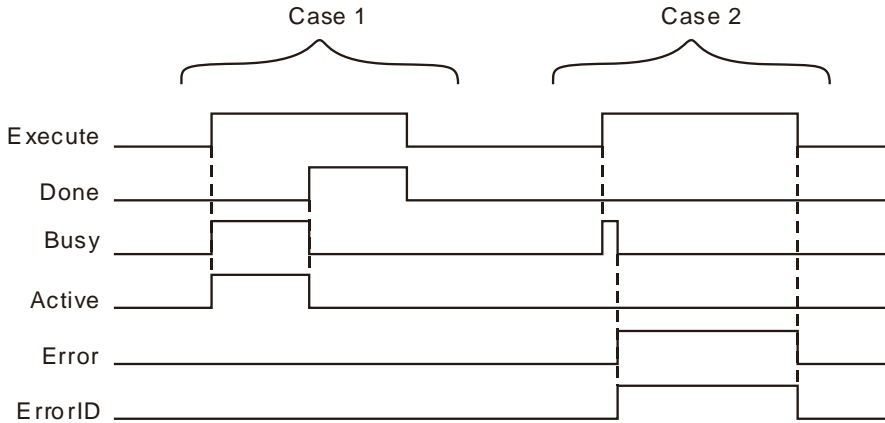

Case 1 : When *Execute* changes from FALSE to TRUE, *Busy* and *Active* change to TRUE. One cycle later, *Done* changes to TRUE. After *Done* changes to TRUE, *Busy* and *Active* change to FALSE in the same cycle. When *Execute* changes from TRUE to FALSE, *Done* changes from TRUE to FALSE.

Case 2 : The input parameter value is illegal such as axis number: 0 before the DMC_WriteParameter_Motion instruction is executed. When *Execute* changes from FALSE to TRUE, *Error* changes to from FALSE to TRUE and *ErrorID* shows corresponding error code. When *Execute* changes from TRUE to FALSE, *Error* changes from TRUE to FALSE and the content of *ErrorID* is cleared to 0.

● Function

DMC_WriteParameter_Motion sets a slave parameter value. Users can specify the index and subindex of the parameter which is to be set.



Programming Example

The example of executing the DMC_WriteParameter_Motion instruction is described as follows.

1. The variable table and program

Variable name	Data type	Initial value
ReadPm_M1	DMC_ReadParameter_Motion	
Axis1	USINT	1
ReadPm_M1_Ex	BOOL	TRUE
ReadPm_M1_Done	BOOL	TRUE
ReadPm_M1_Bsy	BOOL	FALSE
ReadPm_M1_Act	BOOL	FALSE
ReadPm_M1_Err	BOOL	FALSE
ReadPm_M1_ErrID	WORD	FALSE
ReadPm_M1_DaTy	USINT	2
ReadPm_M1_Dat	UDINT	5000
WritePm_M	DMC_WriteParameter_Motion	
WritePm_M_Done	BOOL	TRUE
WritePm_M_Bsy	BOOL	FALSE
WritePm_M_Act	BOOL	FALSE
WritePm_M_Err	BOOL	FALSE
WritePm_M_ErrID	WORD	FALSE
ReadPm_M2	DMC_ReadParameter_Motion	
ReadPm_M2_Done	BOOL	TRUE
ReadPm_M2_Bsy	BOOL	FALSE
ReadPm_M2_Act	BOOL	FALSE
ReadPm_M2_Err	BOOL	FALSE
ReadPm_M2_ErrID	WORD	FALSE
ReadPm_M2_DaTy	USINT	2
ReadPm_M2_Dat	UDINT	1000

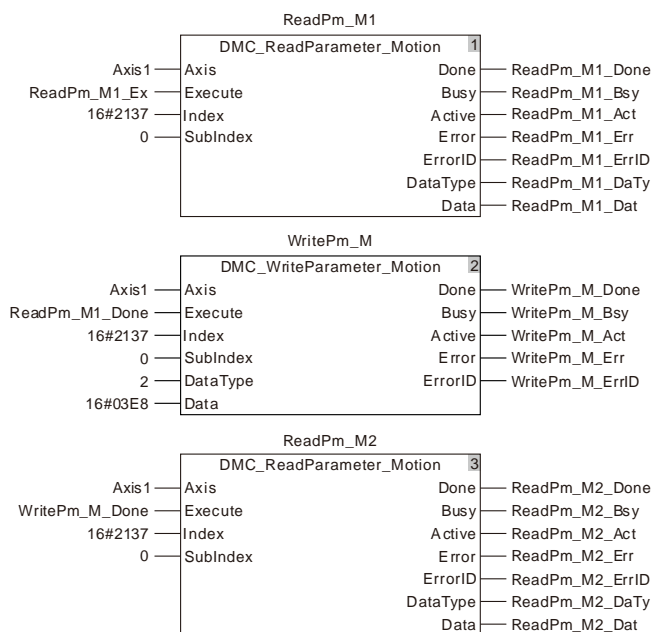

2. Timing Chart

11

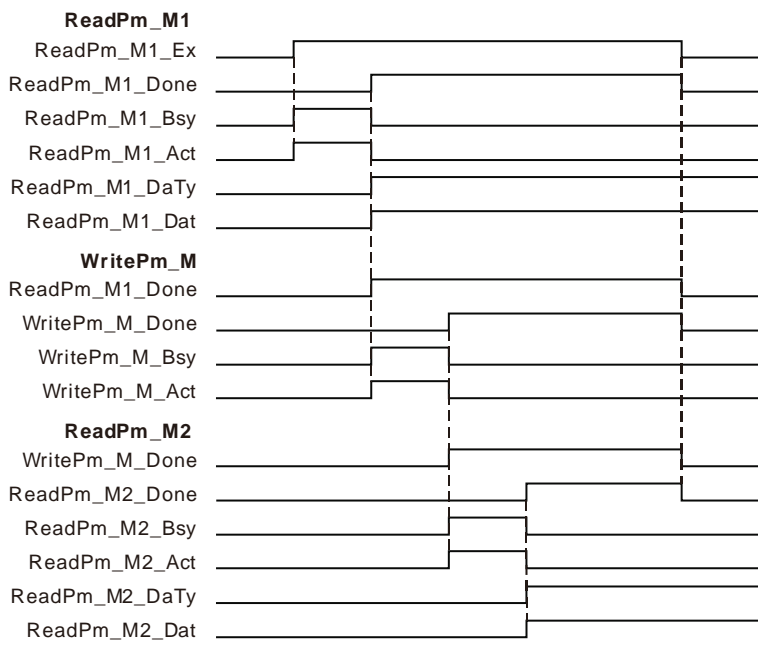

- ❖ When `ReadPm_M1_Ex` changes from FALSE to TRUE, executing the first `DMC_ReadParameter_Motion` instruction starts. After the instruction execution is completed, `ReadPm_M1_Done` changes to TRUE, `ReadPm_M1_DaTy` is 2 and `ReadPm_M1_Dat` is 5000. That is, the content of the servo slave parameter P1-55 which is read is 5000. (The maximum velocity of the servo is limited to 5000rpm.)
- ❖ When `ReadPm_M1_Done` changes from FALSE to TRUE, executing `DMC_WriteParameter_Motion` starts. When the instruction execution is completed, `WritePm_M_Done` changes to TRUE. That means the content of the servo slave parameter P1-55 which is set is 1000. (The maximum velocity of the servo is limited to 1000rpm.)
- ❖ When `WritePm_M_Done` changes from FALSE to TRUE, executing the second `DMC_ReadParameter_Motion` instruction starts. When the instruction execution is completed, `ReadPm_M2_Done` changes to TRUE, `ReadPm_M2_DaTy` is 2 and `ReadPm_M2_Dat` is 1000. That is, the content of the servo slave parameter P1-55 which is read is 1000. (The maximum velocity of the servo is limited to 1000rpm.)

11.3.21 DMC_TouchProbe

FB/FC	Explanation	Applicable model
FB	DMC_TouchProbe is used for capturing the position of an axis.	DVP15MC11T DVP15MC11T-06

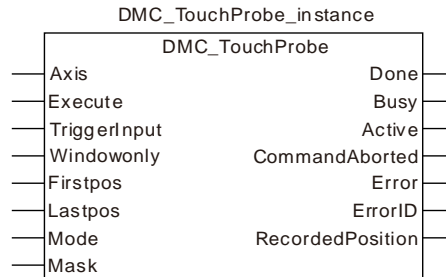

● Input Parameters

Parameter name	Function	Data type	Valid range (Default)	Validation timing
Axis	Specify the number of the axis which is to be controlled.	USINT	Refer to Functions of Section 2.2. (The variable value must be set)	When <i>Execute</i> changes from FALSE to TRUE
Execute	The instruction is executed when <i>Execute</i> changes from FALSE to TRUE.	BOOL	TRUE or FALSE (FALSE)	-
TriggerInput	Specify one of the input points I0~I7, I10~I17 of the motion controller as the bit for triggering position capture. The values of the parameter 0~15 correspond to input points I0~I7 and I10~I17. The parameter is valid when <i>Mode</i> is 0 and 1 and invalid when <i>Mode</i> is 2, 3 and 4.	MC_Triggerinput	0:mcTriggerinput0 ... 7: mcTriggerinput7 8:mcTriggerinput10 ... 15: mcTriggerinput17 (0)	
Windowonly	Reserved	-	-	-
Firststops	Reserved	-	-	-
Lastops	Reserved	-	-	-
Mode	Mode 0: The trigger signal comes from the rising edge of the input points: I0~I7 and I10~I17 of the motion controller. The input point which is used is specified by <i>TriggerInput</i> . The position is captured through the rising edge of the trigger bit. The captured position is converted from the number of pulses that the external encoder port of the controller receives through axis parameters. Mode 1: The trigger signal comes from the falling edge of one of the input points: I0~I7 and I10~I17 of the motion controller, which is specified by <i>TriggerInput</i> . The	INT		

11

Parameter name	Function	Data type	Valid range (Default)	Validation timing								
	<p>captured position is converted from the number of pulses that the external encoder port of the controller receives through axis parameters.</p> <p>Mode 2: The trigger signal comes from the rising edge of the input point of the servo drive. The captured position is converted from the number of pulses which the servo motor feeds back to the servo drive through axis parameters.</p> <p>Mode 3: The trigger signal comes from the rising edge of the input point of the servo drive. The captured position is converted from the number of pulses that CN1 port of the servo drive receives through axis parameters.</p> <p>Mode 4: The trigger signal comes from the rising edge of the input point of the servo drive. The captured position is converted from the number of pulses that CN5 port of the servo drive receives through axis parameters.</p> <p>For the capture which is conducted by using the input point of a servo drive, different servo drive models correspond to different input points as shown in the table below.</p> <table border="1"> <tr> <td>Servo drive model</td> <td>A2-M</td> <td>B3-M</td> <td>A3-M</td> </tr> <tr> <td>Input point</td> <td>DI7</td> <td>DI3</td> <td>DI7</td> </tr> </table>	Servo drive model	A2-M	B3-M	A3-M	Input point	DI7	DI3	DI7			
Servo drive model	A2-M	B3-M	A3-M									
Input point	DI7	DI3	DI7									
Mask	Reserved	-	-	-								

Notes:

1. In Mode 0 and mode 1, the same input point cannot be used for the position capture simultaneously.
2. In Mode 2, mode 3 and mode 4, the position capture cannot be performed for the same axis simultaneously.

● **Output Parameters**

Parameter name	Function	Data type	Valid range
Done	TRUE when the instruction execution is completed.	BOOL	TRUE / FALSE
Busy	TRUE when the instruction is being executed.	BOOL	TRUE / FALSE
Active	TRUE when the axis is being controlled.	BOOL	TRUE / FALSE
CommandAborted	TRUE when the instruction is aborted.	BOOL	TRUE / FALSE
Error	TRUE when there is an error in the execution of the instruction.	BOOL	TRUE / FALSE
ErrorID	Contains error codes when an error occurs. Please refer to section 12.2 for the corresponding error code.	WORD	

Parameter name	Function	Data type	Valid range
RecordedPosition	The captured position after the completion of the instruction execution. Refer to the following Function for details.	LREAL	

● Output Update Timing

Name	Timing for changing to TRUE	Timing for changing to FALSE
Done	◆ When the instruction execution is completed.	◆ When <i>Execute</i> changes from TRUE to FALSE
Busy	◆ When <i>Execute</i> changes to TRUE.	◆ When <i>Done</i> changes to TRUE. ◆ When <i>Error</i> changes to TRUE. ◆ When <i>CommandAborted</i> changes to TRUE.
Active	◆ When <i>Execute</i> changes to TRUE.	◆ When <i>Done</i> changes to TRUE. ◆ When <i>Error</i> changes to TRUE. ◆ When <i>CommandAborted</i> changes to TRUE.
CommandAborted	◆ When the instruction execution is aborted by some other motion control instruction.	◆ When <i>Execute</i> changes from TRUE to FALSE ◆ <i>CommandAborted</i> is set to TRUE when the instruction execution is aborted after <i>Execute</i> changes from TRUE to FALSE during the instruction execution. One period later, <i>CommandAborted</i> changes to FALSE.
Error	◆ When an error occurs in the instruction execution or the input parameters for the instruction are illegal.	◆ When <i>Execute</i> changes from TRUE to FALSE

● Output Update Timing Chart

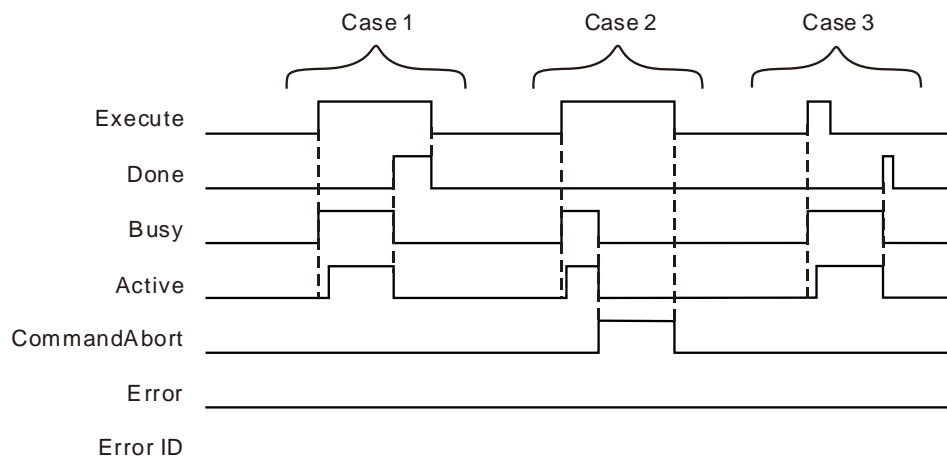

Case 1 : When *Execute* changes from FALSE to TRUE, *Busy* changes to TRUE and one period later, *Active* changes to TRUE. When positioning is completed, *Done* changes to TRUE and meanwhile *Busy* and *Active* change to FALSE.

Case 2 : When *Execute* changes from FALSE to TRUE and the instruction is aborted by other instruction, *CommandAborted* changes to TRUE and meanwhile *Busy* and *Active* change to FALSE. When *Execute* changes from TRUE to FALSE, *CommandAborted* changes to FALSE.

Case 3 : During execution of the instruction, *Done* changes to TRUE when the instruction execution is completed after *Execute* changes from TRUE to FALSE. Meanwhile, *Busy* and *Active* change to FALSE and one period later, *Done* changes to FALSE.

11

● **Function**

- (*RecordedPosition*) the position that DMC_TouchProbe captures is converted from other value based on axis parameters. The data sources for conversion are listed in the following table.

Mode	Data source
Mode 0 and mode 1	The number of pulses that the external encoder port of the motion controller receives
Mode 2	The number of pulses that the servo motor feeds back to the servo drive
Mode 3	The number of pulses that the pulse, /pulse, sign and /sign input terminals of CN1 port of the servo drive receive.
Mode 4	The number of pulses that A, /A, B and /B input terminals of CN5 port of the servo drive receive.

- For mode 0, 1 or 2, the range of the data source value is -2147483648~2147483647. When the data source value exceeds 2147483647, it will become -2147483648. With the changing + or - sign of the data source value, the + or - sign of the value of *RecordedPosition* will not change but the value of *RecordedPosition* will continue to increase.
- For mode 3 or 4, the range of the data source value is -2147483648~2147483647. When the data source value exceeds 2147483647, it will become -2147483648. The value of *RecordedPosition* will change from a positive number to a negative number.
- The position captured by the DMC_TouchProbe instruction is calculated according to axis parameters. For different modes, the data sources are different. “Servo gear ratio setting” and “Mechanism gear ratio setting” in axis parameters are shown in the following table. When *Mode* value of the instruction is equal to 3 (which you can refer to the introduction of mode 3 below), the number of pulses received at pulse, /pulse, sign and /sign of CN1 is 435 and the position captured by the instruction is 65.25. The calculation formula: $435 \times (3 \times 1000) \div (2 \times 10000) = 65.25$. 10000, 2, 3 and 1000 in the formula correspond to 10000, 2, 3, and 1000 in the following table respectively. For other mode, the calculation method for the position captured by the instruction is the same as that described above but only the data source is different.

Servo gear ratio setting	Mechanism gear ratio setting
Unit Numerator: 128	Output rotations of gear: 3
Unit Denominator: 1	Input rotations of gear: 2
Pulses per rotation:10000	Units per output rotation: 1000 units/rotation

- When *Mode*=0 or 1 in DMC_TouchProbe, the captured position can be calculated according to the method mentioned above as well. In actual application, the position capture is generally performed by building an external encoder axis. When the number of pulses received at the external encoder interface of the motion controller is 638, the position captured by DMC_TouchProbe is 95.4. The calculation formula: $638 \times (3 \times 1000) \div (2 \times 10000) = 95.4$. In the formula, 1000 is *Units per output rotation*, 2 is *Input rotations of gear*, 3 is *Output rotations of gear* and 10000 is *number of pulses per rotation*). When I0 changes from OFF to ON once, the position capture is performed once.

● **Wiring Figure**

■ **Mode 0 and mode 1**

Mode 0: The external signal triggers I point of the motion controller and the position capture is conducted through the rising edge of the input point specified by *TriggerInput*. The captured

position is converted from the number of pulses the external encoder port of the controller receives through axis parameters.

Mode 1: The external signal triggers I point of the motion controller and the position capture is conducted through the falling edge of the input point specified by *TriggerInput*. The captured position is converted from the number of pulses the external encoder port of the controller receives through axis parameters.

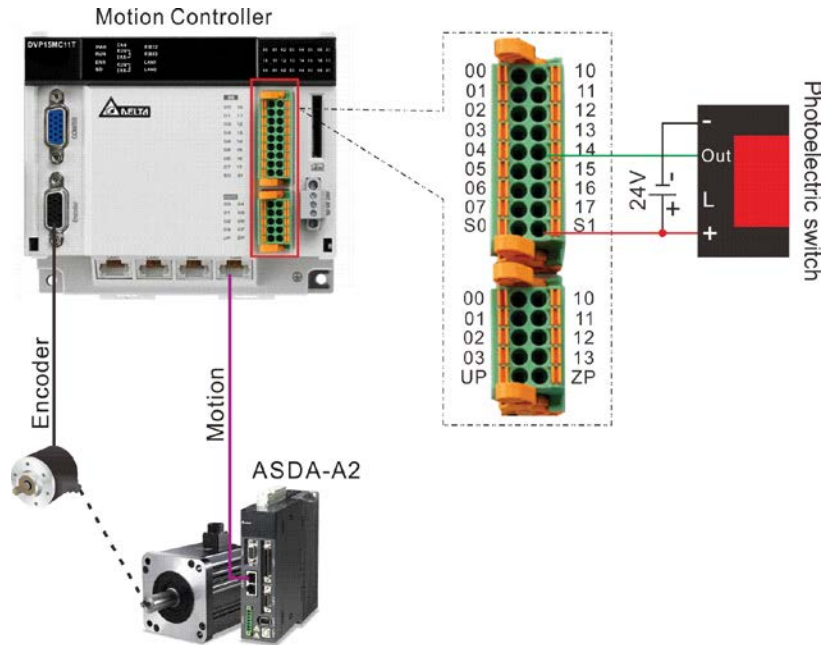

■ Mode 2

The external signal triggers the high-speed input point: DI7 of the servo drive. The position captured is converted from the number of pulses which the servo motor feeds back to the servo drive through axis parameters.

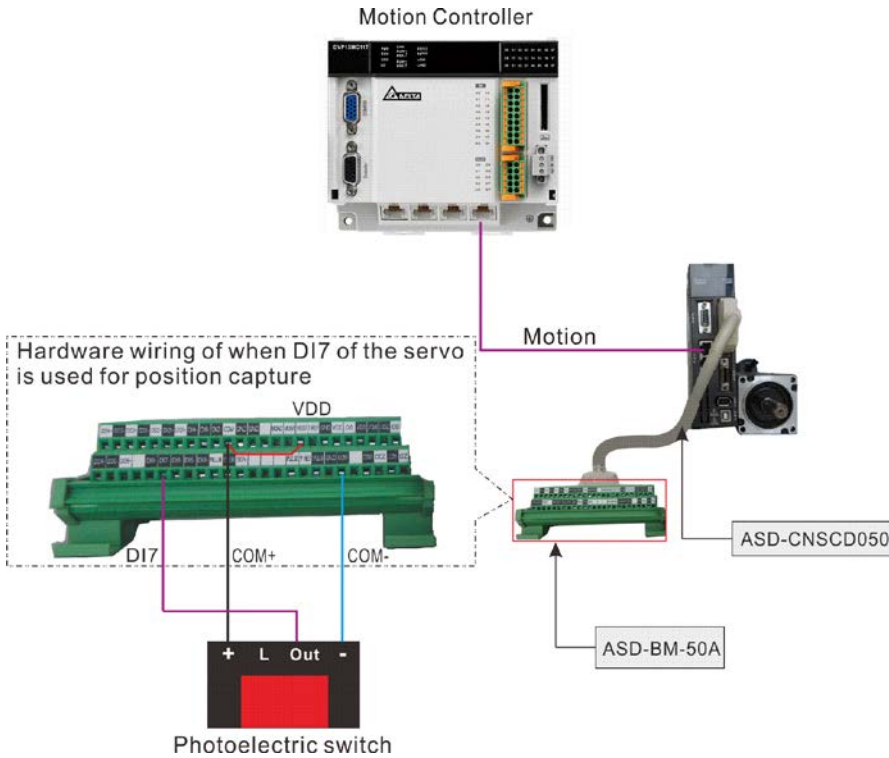

■ **Mode 3**

The external signal triggers the high-speed input point: DI7 of the servo drive. The captured position is converted from the number of pulses CN1 port of the servo drive receives through axis parameters.

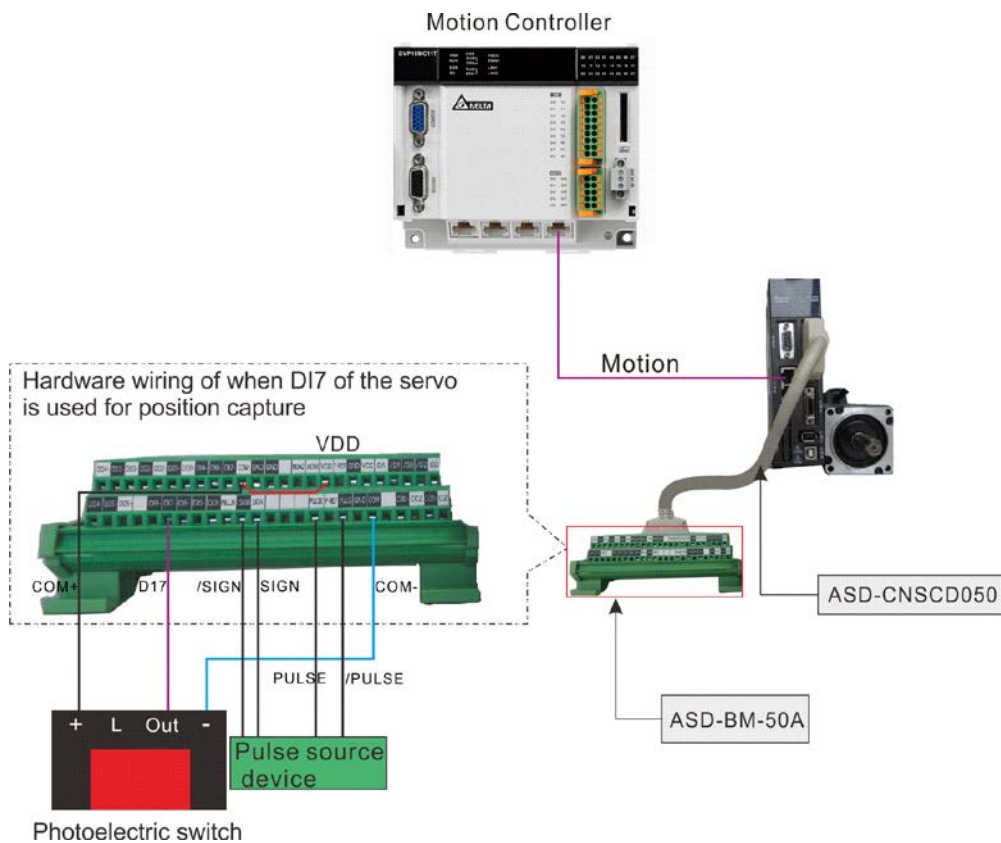

■ **Mode 4**

The external signal triggers the high-speed input point: DI7 of the servo drive. The captured position is converted from the number of pulses CN5 port of the servo drive receives through axis parameters.

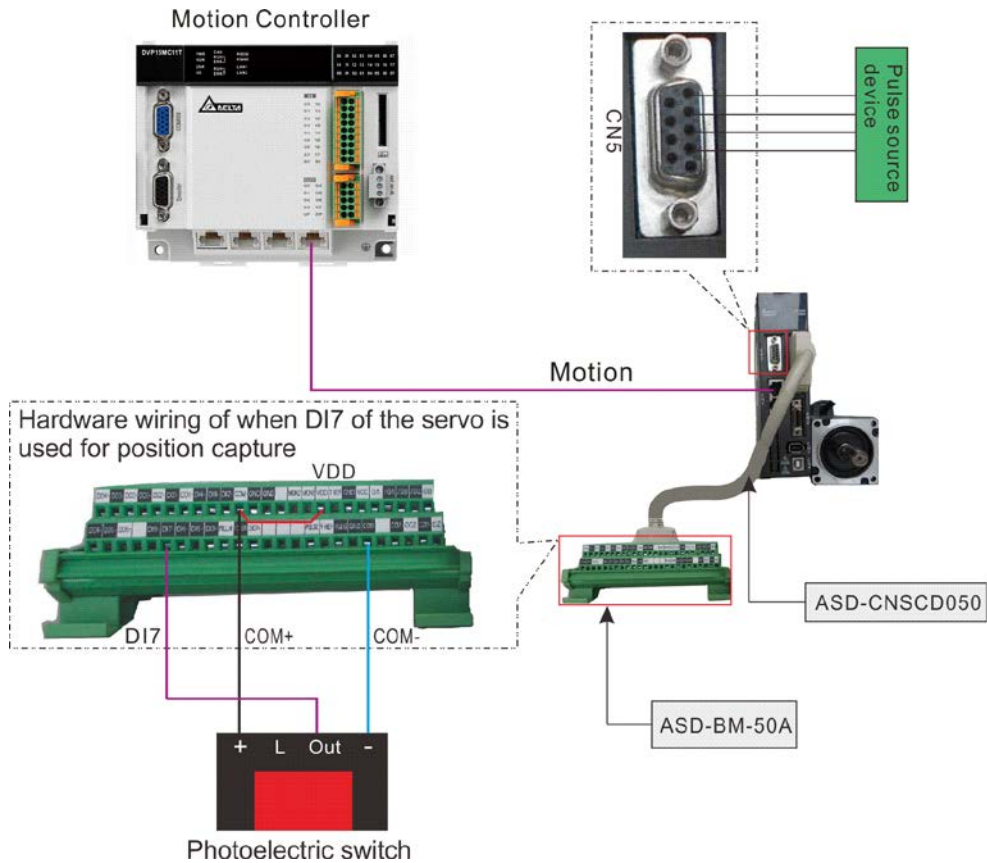

Programming Example 1

Capture the position of the external encoder axis by using the rising edge of IO under mode 0.

1. The variable table and program

Variable name	Data type	Initial value
NOT_EN	BOOL	FALSE
NOT_ENO	BOOL	
Touch	DMC_TouchProbe	
Axis1	USINT	3
Touch_Ex	BOOL	FALSE
Touch_Tri	MC_Triggerinput	0
Touch_Mode	INT	0
Touch_Done	BOOL	
Touch_Bsy	BOOL	
Touch_Act	BOOL	
Touch_Abt	BOOL	
Touch_Err	BOOL	
Touch_ErrID	UINT	
Touch_Pos	LREAL	

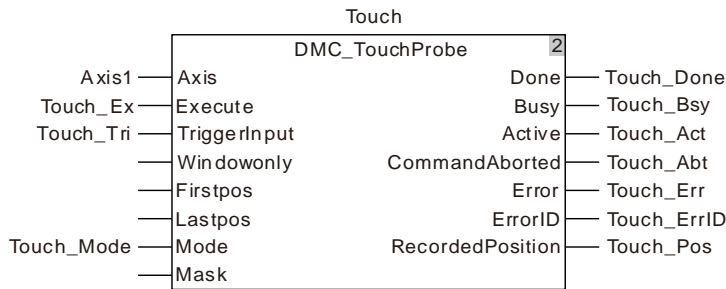
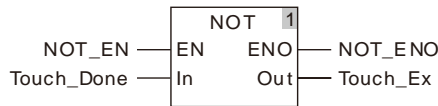

2. Timing Chart

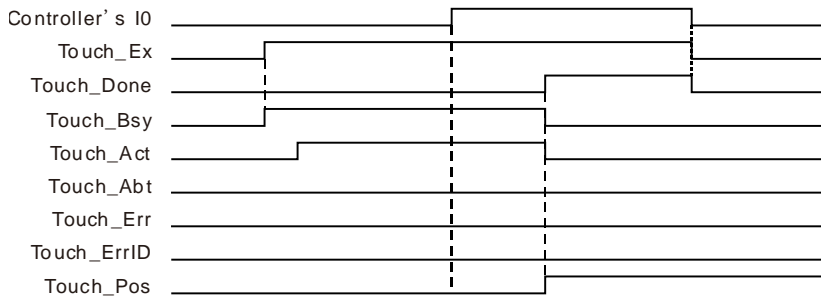

- ❖ When Touch_Ex changes from FALSE to TRUE, Touch_Bsy changes from FALSE to TRUE in the first cycle and Touch_Act changes from FALSE to TRUE in the second cycle.
- ❖ When the external signal triggers controller's I/O, DMC_TouchProbe starts to execute. When Touch_Done changes from FALSE to TRUE, the position Touch_Pos outputs is converted from the number of pulses that the external encoder port of the controller receives through axis parameters. Meantime Touch_Bsy and Touch_Act change from TRUE to FALSE. When Touch_Ex changes from TRUE to FALSE, Touch_Done changes from TRUE to FALSE and the position that Touch_Pos captures will not be cleared to 0

Programming Example 2

Capture the position converted from the number of pulses that the servo motor feeds back to the servo drive according to axis parameters when the external signal triggers DI7 of servo's CN1 under Mode 2.

1. The variable table and program

Variable name	Data type	Initial value
NOT_EN	BOOL	FALSE
NOT_ENO	BOOL	
Touch1	DMC_TouchProbe	
Axis2	USINT	1
Touch1_Ex	BOOL	FALSE
Touch1_Tri	MC_Triggerinput	
Touch1_Mode	INT	2
Touch1_Done	BOOL	
Touch1_Bsy	BOOL	
Touch1_Act	BOOL	
Touch1_Abt	BOOL	
Touch1_Err	BOOL	
Touch1_ErrID	UINT	
Touch1_Pos	LREAL	

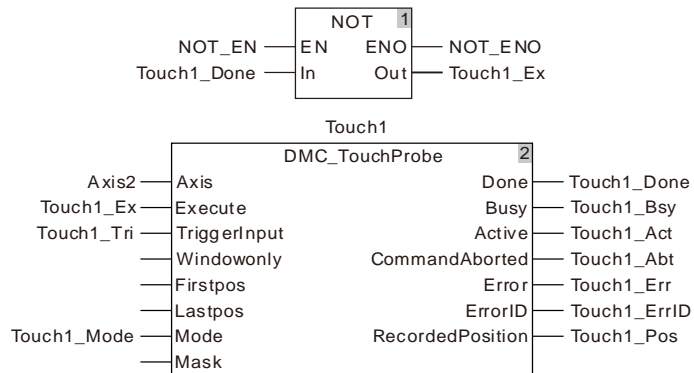

2. Timing Chart

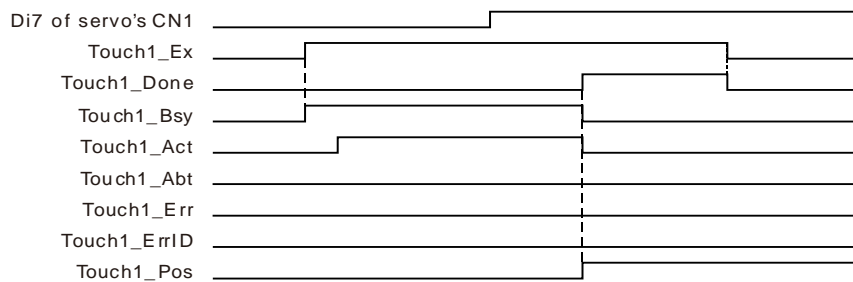

- ❖ When Touch1_Ex changes from FALSE to TRUE, Touch1_Bsy changes from FALSE to TRUE in the first cycle and Touch1_Act changes from FALSE to TRUE in the second cycle.
- ❖ When the execution of DMC_TouchProbe is finished after the external signal triggers DI7 of servo's CN1, Touch1_Done changes from FALSE to TRUE and Touch1_Pos outputs the position converted from the number of pulses which the servo motor feeds back to the servo drive according to the axis parameters. Meantime Touch1_Bsy and Touch1_Act change from TRUE to FALSE. When Touch1_Ex changes from TRUE to FALSE, Touch1_Done changes from TRUE to FALSE and the position that Touch1_Pos captures will not be cleared to 0.

11.3.22 DMC_TouchProbeCyclically

FB/FC	Explanation	Applicable model
FB	DMC_TouchProbeCyclically is used for capturing the position of an axis cyclically.	DVP15MC11T DVP15MC11T-06

11

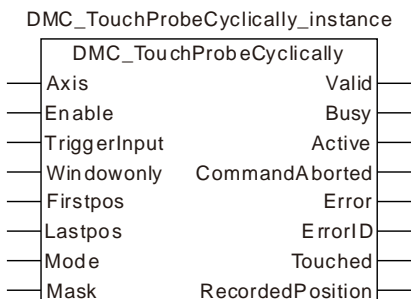

● Input Parameters

Parameter name	Function	Data type	Valid range (Default)	Validation timing
Axis	Specify the number of the axis which is to be operated.	USINT	Refer to Functions of Section 2.2. (The variable value must be set)	When <i>Execute</i> changes from FALSE to TRUE
Enable	The instruction is enabled when <i>Enable</i> changes from FALSE to TRUE.	BOOL	TRUE or FALSE (FALSE)	-
TriggerInput	Specify one of the input points I0~I7, I10~I17 of the motion controller as the bit for triggering position capture. The values of the parameter 0~15 correspond to input points I0~I7 and I10~I17. The parameter is valid when <i>Mode</i> is 0 and 1 and invalid when <i>Mode</i> is 2, 3 and 4.	MC_Triggerinput	0: mcTriggerinputI0 ... 7: mcTriggerinputI7 8: mcTriggerinputI10 ... 15: mcTriggerinputI17 (0)	
Windowonly	Reserved	-	-	-
Firststops	Reserved	-	-	-
Lastops	Reserved	-	-	-
Mode	<p>Mode 0: The trigger signal comes from the rising edge of the input points: I0~I7 and I10~I17 of the motion controller. The input point which is used is specified by <i>TriggerInput</i>. The position is captured through the rising edge of the trigger bit. The captured position is converted from the number of pulses that the external encoder port of the controller receives through axis parameters.</p> <p>Mode 1: The trigger signal comes from the falling edge of one of the input points: I0~I7 and I10~I17 of the motion controller, which</p>	INT		

Parameter name	Function	Data type	Valid range (Default)	Validation timing								
	<p>is specified by <i>TriggerInput</i>. The captured position is converted from the number of pulses that the external encoder port of the controller receives through axis parameters.</p> <p>Mode 2: The trigger signal comes from the rising edge of the input point of the servo drive. The captured position is converted from the number of pulses which the servo motor feeds back to the servo drive through axis parameters.</p> <p>Mode 3: The trigger signal comes from the rising edge of the input point of the servo drive. The captured position is converted from the number of pulses that CN1 port of the servo drive receives through axis parameters.</p> <p>Mode 4: The trigger signal comes from the rising edge of the input point of the servo drive. The captured position is converted from the number of pulses that CN5 port of the servo drive receives through axis parameters.</p> <p>For the cyclical capture which is conducted by using the input point of a servo drive, different servo drive models correspond to different input points as shown in the table below.</p> <table border="1"> <tbody> <tr> <td>Servo drive model</td> <td>A2-M</td> <td>B3-M</td> <td>A3-M</td> </tr> <tr> <td>Input point</td> <td>DI7</td> <td>DI3</td> <td>DI7</td> </tr> </tbody> </table>	Servo drive model	A2-M	B3-M	A3-M	Input point	DI7	DI3	DI7			
Servo drive model	A2-M	B3-M	A3-M									
Input point	DI7	DI3	DI7									
Mask	Reserved	-	-	-								

Notes:

1. In Mode 0 and mode 1, the same input point cannot be used for the position capture simultaneously.
2. In Mode 2, mode 3 and mode 4, the position capture cannot be performed for the same axis simultaneously.

● **Output Parameters**

Parameter name	Function	Data type	Valid range
Valid	TRUE when the captured value is valid.	BOOL	TRUE / FALSE
Busy	TRUE when the instruction is being executed.	BOOL	TRUE / FALSE
Active	TRUE when the axis is being controlled.	BOOL	TRUE / FALSE
CommandAborted	TRUE when the instruction is aborted.	BOOL	TRUE / FALSE

Parameter name	Function	Data type	Valid range
Error	TRUE when there is an error in the execution of the instruction.	BOOL	TRUE / FALSE
ErrorID	Contains error codes when an error occurs. Please refer to section 12.2 for the corresponding error code.	WORD	
Touched	TRUE when one capture is finished by the instruction.		
RecordedPosition	The captured position after the completion of the instruction execution.	LREAL	

● Output Update Timing

Name	Timing for changing to TRUE	Timing for changing to FALSE
Valid	◆ When the instruction execution is normal as <i>Enable</i> is TRUE.	◆ When <i>Execute</i> changes from TRUE to FALSE
Busy	◆ When <i>Enable</i> changes to TRUE.	◆ When <i>Done</i> changes to TRUE. ◆ When <i>Error</i> changes to TRUE. ◆ When <i>CommandAborted</i> changes to TRUE.
Active	◆ When <i>Enable</i> changes to TRUE.	◆ When <i>Done</i> changes to TRUE. ◆ When <i>Error</i> changes to TRUE. ◆ When <i>CommandAborted</i> changes to TRUE.
CommandAborted	◆ When the instruction execution is aborted by some other motion control instruction.	◆ When <i>Execute</i> changes from TRUE to FALSE ◆ <i>CommandAborted</i> is set to TRUE when the instruction execution is aborted after <i>Execute</i> changes from TRUE to FALSE during the instruction execution. One period later, <i>CommandAborted</i> changes to FALSE.
Error	◆ When an error occurs in the instruction execution or the input parameters for the instruction are illegal.	◆ When <i>Execute</i> changes from TRUE to FALSE

● Output Update Timing Chart

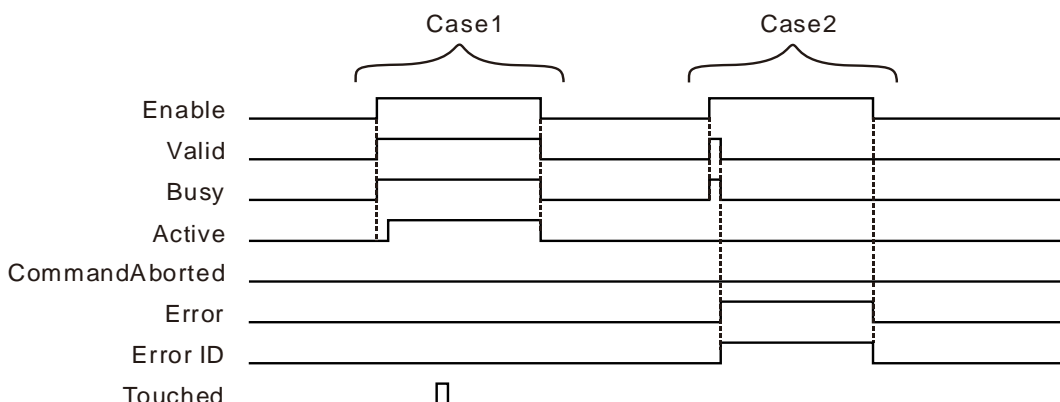

Case 1 : When *Enable* changes from FALSE to TRUE, *Valid* and *Busy* change to TRUE. One period later, *Active* changes to TRUE. When one capture is completed, *Touched* changes to TRUE and the TRUE state will last for one period. When *Enable* changes from TRUE to FALSE, *Valid*, *Busy* and *Active* change to FALSE.

Case 2 : When an error exists in input parameters and *Enable* changes from FALSE to TRUE, *Busy* and

Valid change to TRUE. One period later, *Error* changes to TRUE and *ErrorID* shows corresponding error codes and meanwhile *Busy* and *Valid* change to FALSE. When *Enable* changes from TRUE to FALSE, *Error* changes to FALSE and the value of *ErrorID* will be cleared.

- **Function**

DMC_TouchProbeCyclically is used for capturing the position of an axis cyclically. The function is similar to that of DMC_TouchProbe. The difference is that the axis position can be captured cyclically by the instruction as *Enable* changes to TRUE. That is, as an external signal is detected, the instruction performs the position capture immediately without having to be re-triggered. Refer to [DMC_TouchProbe](#) for details on functions.

11.3.23 DMC_Jog

FB/FC	Explanation	Applicable model
FB	DMC_Jog jogs an axis.	DVP15MC11T DVP15MC11T-06

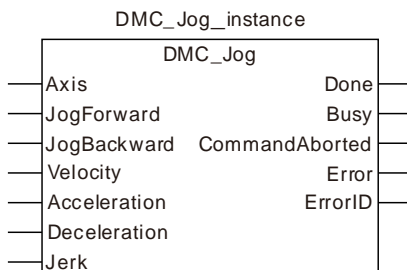

● Input Parameters

Parameter name	Function	Data type	Valid range (Default)	Validation timing
Axis	Specify the number of the axis which is to be controlled.	USINT	Refer to Functions of Section 2.2. (The variable value must be set)	When <i>JogForward</i> or <i>JogBackward</i> is TRUE
JogForward	The instruction is executed when <i>JogForward</i> changes from FALSE to TRUE.	BOOL	TRUE or FALSE (FALSE)	
JogBackward	The instruction is executed when <i>JogBackward</i> changes from FALSE to TRUE.	BOOL	TRUE or FALSE (FALSE)	
Velocity	Specify the target velocity. (Unit: Unit/second)	LREAL	Positive number (The variable value must be set)	When <i>JogForward</i> or <i>JogBackward</i> is TRUE
Acceleration	Specify the target acceleration rate. (Unit: Unit/s ²)	LREAL	Positive number (The variable value must be set)	When <i>JogForward</i> or <i>JogBackward</i> is TRUE
Deceleration	Specify the target deceleration rate. (Unit: Unit/s ²)	LREAL	Positive number (The variable value must be set)	When <i>JogForward</i> or <i>JogBackward</i> is TRUE
Jerk	Specify the change rate of the target acceleration or deceleration. (Unit: Unit/s ³)	LREAL	Positive number (The variable value must be set)	When <i>JogForward</i> or <i>JogBackward</i> is TRUE

● Output Parameters

Parameter name	Function	Data type	Valid range
Done	TRUE when the jogging is finished.	BOOL	TRUE/FALSE
Busy	TRUE when the instruction is being executed.	BOOL	TRUE/FALSE
CommandAborted	TRUE when the instruction is aborted. °	BOOL	TRUE/FALSE

Parameter name	Function	Data type	Valid range
Error	TRUE when there is an error in the execution of the instruction.	BOOL	TRUE/FALSE
ErrorID	Contains the error code when an error occurs. Please refer to section 12.2.	WORD	-

● Output Update Timing

Name	Timing for changing to TRUE	Timing for changing to FALSE
Done	◆ When the jogging stops.	◆ One period later after the jogging stops.
Busy	◆ When <i>JogForward</i> or <i>JogBackward</i> changes to TRUE.	◆ When <i>Done</i> changes to TRUE, ◆ When <i>Error</i> changes to TRUE, ◆ When <i>CommandAborted</i> changes to TRUE.
CommandAborted	◆ TRUE when the instruction is aborted by other motion instruction.	◆ When <i>JogForward</i> or <i>JogBackward</i> changes from TRUE to FALSE.
Error	◆ When an error occurs in the instruction execution or the input parameters for the instruction are illegal.	◆ When <i>JogForward</i> or <i>JogBackward</i> changes from TRUE to FALSE.

● Output Update Timing Chart

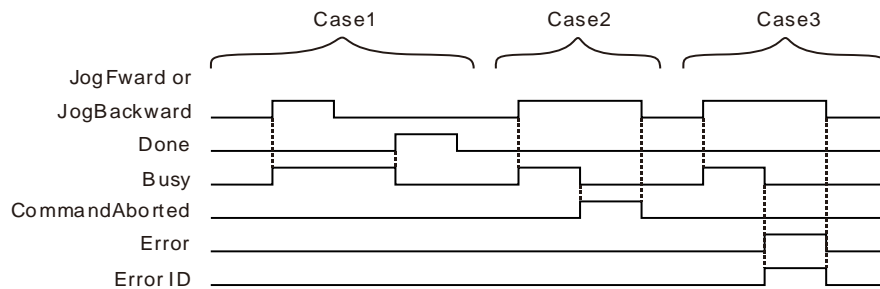

Case 1 : When *JogForward* or *JogBackward* changes from FALSE to TRUE, *Busy* changes to TRUE. When the jogging stops, the velocity of the axis is decreased to 0, *Done* changes to TRUE and *Busy* changes to FALSE.

Case 2 : When *JogForward* or *JogBackward* changes from FALSE to TRUE, *CommandAborted* changes to TRUE and meanwhile, *Busy* changes to FALSE after the instruction is aborted by other motion instruction. *CommandAborted* changes to FALSE when *JogForward* or *JogBackward* changes from TRUE to FALSE.

Case 3 : After *JogForward* or *JogBackward* changes from FALSE to TRUE, *Error* will change to TRUE and *ErrorID* will show corresponding error codes if any error occurs such as axis alarm or Offline. Meanwhile, *Busy* will change to FALSE. *Error* will change to FALSE and the value of *ErrorID* will be cleared to 0 when *JogForward* or *JogBackward* changes from TRUE to FALSE.

● Function

DMC_Jog jogs an axis. The *JogForward* parameter controls the axis to run forward and the *JogBackward* parameter controls the axis to run backward. When the jogging stops, *Done* changes to TRUE and one cycle later, it changes to FALSE. Meanwhile, *Busy* changes to FALSE.

11.3.24 DMC_MoveVelocityStopByPos

FB/FC	Explanation	Applicable model
FB	DMC_MoveVelocityStopByPos is used for making an axis stop at the specified phase.	DVP15MC11T DVP15MC11T-06

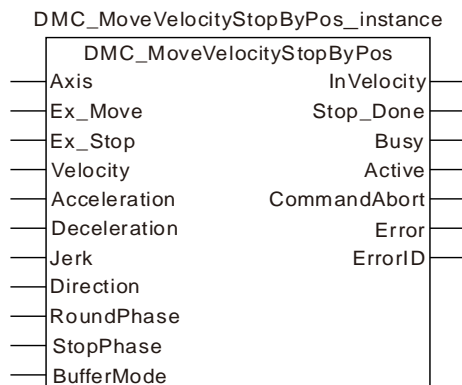

● Input Parameters

Parameter name	Function	Data type	Valid range (Default)	Validation timing
Axis	Specify the number of the axis which is to be controlled.	USINT	Refer to Functions of Section 2.2. (The variable value must be set)	When <i>Ex_Move</i> changes to TRUE.
Ex_Move	The instruction controls the axis to run when <i>Ex_Move</i> changes from FALSE to TRUE.	BOOL	TRUE or FALSE (FALSE)	
Ex_Stop	The instruction controls the axis to run when <i>Ex_Stop</i> changes from FALSE to TRUE.	BOOL	TRUE or FALSE (FALSE)	
Velocity	Specify the target velocity. (Unit: Unit/second)	LREAL	Positive number (The variable value must be set)	When <i>Ex_Move</i> changes to TRUE.
Acceleration	Specify the target acceleration rate. (Unit: Unit/s ²)	LREAL	Positive number (The variable value must be set)	When <i>Ex_Move</i> changes to TRUE.
Deceleration	Specify the target deceleration rate. (Unit: Unit/s ²)	LREAL	Positive number (The variable value must be set)	When <i>Ex_Move</i> changes to TRUE.
Jerk	Specify the change rate of the target acceleration or deceleration. (Unit: Unit/s ³)	LREAL	Positive number (The variable value must be set)	When <i>Ex_Move</i> changes to TRUE.
Direction	Specify the rotation direction 1: Positive direction 3: Negative direction	MC_Direction	1: mcPositiveDirection, 3: mcNegativeDirection (1)	When <i>Ex_Move</i> changes to TRUE.
RoundPhase	Specify the modulo that	LREAL	Positive number	When <i>Ex_Move</i>

Parameter name	Function	Data type	Valid range (Default)	Validation timing
	the pitch (UnitsPerRotation) corresponds to.		(The variable value must be set)	changes to TRUE.
StopPhase	Specify a phase in the modulo.	LREAL	0~the setting value of <i>RoundPhase</i> (0)	When <i>Ex_Move</i> changes to TRUE.
BufferMode	Specify the behavior when executing two instructions. 0: Aborting 1: Buffered 2: BlendingLow 3: BlendingPrevious 4: BlendingNext 5: BlendingHigh	MC_Buffer_Mode	0 : mcAborting 1 : mcBuffered 2 : mcBlendingLow 3 : mcBlending_Previous 4 : mcBlending_Next 5 : mcBlending_High (0)	When <i>Ex_Move</i> changes to TRUE.

● Output Parameters

Parameter name	Function	Data type	Valid range
Invelocity	TRUE when the target velocity is reached.	BOOL	TRUE / FALSE
Stop_Done	TRUE when the stop position is reached.	BOOL	TRUE / FALSE
Busy	TRUE when the instruction is being executed.	BOOL	TRUE / FALSE
Active	TRUE when the axis is being controlled by the instruction.	BOOL	TRUE / FALSE
CommandAborted	TRUE when the instruction is aborted.	BOOL	TRUE / FALSE
Error	TRUE when there is an error in the execution of the instruction.	BOOL	TRUE / FALSE
ErrorID	Contains the error code when an error occurs. Please refer to section 12.2.	WORD	

● Output Update Timing

Name	Timing for changing to TRUE	Timing for changing to FALSE
Invelocity	◆ When the target velocity is reached.	◆ When <i>CommandAborted</i> changes to TRUE. ◆ When <i>Error</i> changes to TRUE. ◆ <i>Invelocity</i> changes to FALSE immediately when <i>Ex_Move</i> changes from FALSE to TRUE again if the input parameter values are revised after the target velocity is reached. If the input parameter values are not changed after the instruction execution is completed, <i>Invelocity</i> changes to FALSE immediately when <i>Ex_Move</i> changes from FALSE to TRUE again. <i>Invelocity</i> will change to TRUE in the next cycle.
Stop_Done	◆ When the stop position is reached	◆ When <i>CommandAborted</i> changes to TRUE. ◆ When <i>Error</i> changes to TRUE. ◆ When <i>Ex_Stop</i> changes to FALSE.
Busy	◆ When <i>Ex_Move</i> changes to TRUE.	◆ When <i>CommandAborted</i> changes to TRUE. ◆ When <i>Error</i> changes to TRUE.

Name	Timing for changing to TRUE	Timing for changing to FALSE
Active	◆ When the axis is being controlled by the instruction.	◆ When <i>CommandAborted</i> changes to TRUE. ◆ When <i>Error</i> changes to TRUE.
CommandAborted	◆ TRUE when the instruction is aborted by other motion instruction.	◆ When <i>Ex_Move</i> changes from TRUE to FALSE. ◆ <i>CommandAborted</i> is set to TRUE when the instruction is aborted after <i>Ex_Move</i> and <i>Ex_Stop</i> change from TRUE to FALSE during the instruction execution. One cycle later, <i>CommandAborted</i> changes to FALSE.
Error	◆ When an error occurs in the instruction execution or the input parameters for the instruction are illegal.	◆ When <i>Ex_Move</i> and <i>Ex_Stop</i> change from TRUE to FALSE.

● Output Update Timing Chart

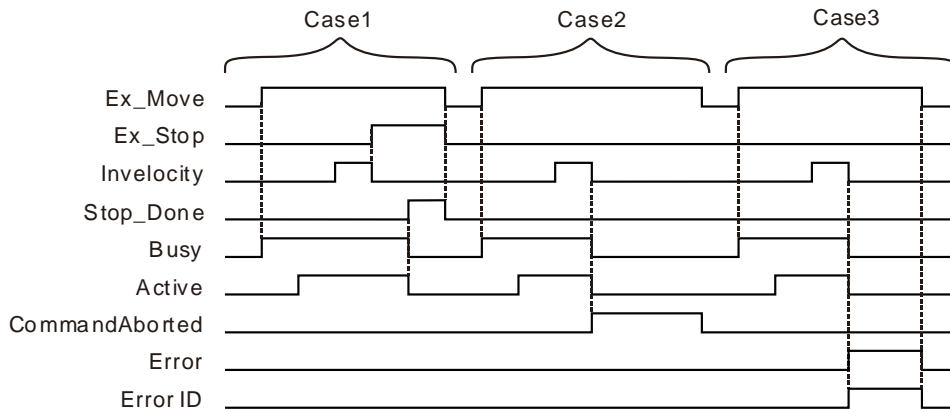

Case 1 : When *Ex_Move* changes from FALSE to TRUE, *Busy* changes to TRUE. When the axis starts being controlled by the instruction, *Active* changes to TRUE. When *Ex_Stop* changes from FALSE to TRUE, *Invelocity* changes to FALSE. When the position is reached, *Stop_Done* changes to TRUE and meanwhile, *Busy* and *Active* change to FALSE. When *Ex_Move* and *Ex_Stop* change from TRUE to FALSE, *Stop_Done* changes to FALSE.

Case 2 : When *Ex_Move* changes to TRUE, the instruction is aborted by other instruction and *CommandAborted* changes to TRUE. Meanwhile, *Invelocity*, *Busy* and *Active* change to FALSE. When *Ex_Move* changes from TRUE to FALSE, *CommandAborted* changes to FALSE.

Case 3 : When an error occurs while *Ex_Move* is TRUE, *Error* changes to TRUE and *ErrorID* shows corresponding error code. Meanwhile, *Invelocity*, *Busy* and *Active* change to FALSE. *Error* changes to FALSE when *Ex_Move* changes from TRUE to FALSE.

● Function

DMC_MoveVelocityStopByPos is used for making an axis stop at a specified phase. **RoundPhase** is the modulo that the pitch (**UnitsPerRotation**) corresponds to. **StopPhase** specifies a phase in the modulo. The value of **StopPhase** should be less than the value of **RoundPhase**.

As **Ex_Move** changes from FALSE to TRUE, the axis is controlled to run. As **Ex_Stop** changes from FALSE to TRUE, the axis is controlled to stop at the phase specified by **StopPhase**. The final position where the axis stops equals an integral multiple of the pitch (**UnitsPerRotation**) + **StopPhase** value/**RoundPhase** value* the pitch value (**UnitsPerRotation**).

The pitch (**UnitsPerRotation**) is 10000, **RoundPhase** is set to 360 and **StopPhase** is set to 90 as

shown in the figure below. And the axis can be controlled to stop at the phase specified by **StopPhase** via the `DMC_MoveVelocityStopByPos` instruction.

The terminal actuator may stop at the position of 12500 units, 22500 units, 32500 units or 42500 units.

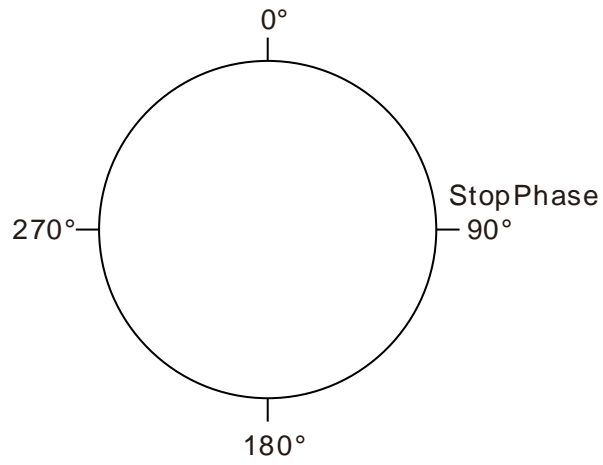

11.3.25 DMC_MoveVelocityStopByLinePos

FB/FC	Explanation	Applicable model
FB	DMC_MoveVelocityStopByLinePos is used for making an axis stop at the specified position.	DVP15MC11T DVP15MC11T-06

DMC_MoveVelocityStopByLinePos_instance

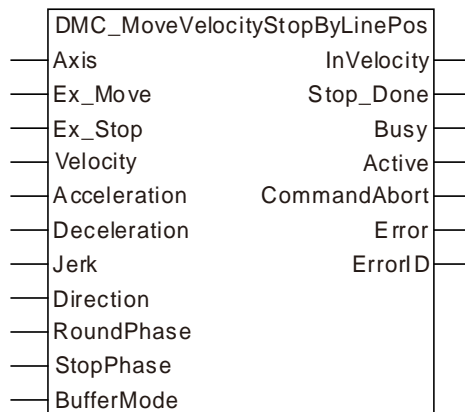

● Input Parameters

Parameter name	Function	Data type	Valid range (Default)	Validation timing
Axis	Specify the number of the axis which is to be controlled.	USINT	Refer to Functions of Section 2.2. (The variable value must be set)	When <i>Ex_Move</i> changes to TRUE.
Ex_Move	The instruction controls the axis to run when <i>Ex_Move</i> changes from FALSE to TRUE.	BOOL	TRUE or FALSE (FALSE)	
Ex_Stop	The instruction controls the axis to run when <i>Ex_Stop</i> changes from FALSE to TRUE.	BOOL	TRUE or FALSE (FALSE)	
Velocity	Specify the target velocity. (Unit: Unit/second)	LREAL	Positive number (The variable value must be set)	When <i>Ex_Move</i> changes to TRUE.
Acceleration	Specify the target acceleration rate. (Unit: Unit/s ²)	LREAL	Positive number (The variable value must be set)	When <i>Ex_Move</i> changes to TRUE.
Deceleration	Specify the target deceleration rate. (Unit: Unit/s ²)	LREAL	Positive number (The variable value must be set)	When <i>Ex_Move</i> changes to TRUE.
Jerk	Specify the change rate of the target acceleration or deceleration. (Unit: Unit/s ³)	LREAL	Positive number (The variable value must be set)	When <i>Ex_Move</i> changes to TRUE.
Direction	Specify the rotation direction 1: Positive direction 3: Negative direction	MC_Direction	1: mcPositiveDirection, 3: mcNegativeDirection (1)	When <i>Ex_Move</i> changes to TRUE.

Parameter name	Function	Data type	Valid range (Default)	Validation timing
RoundPhase	Specify the modulo.	LREAL	Positive number (The variable value must be set)	When <i>Ex_Move</i> changes to TRUE.
StopPhase	Specify a position in the modulo.	LREAL	0~the setting value of <i>RoundPhase</i> (0)	When <i>Ex_Move</i> changes to TRUE.
BufferMode	Specify the behavior when executing two instructions. 0: Aborting 1: Buffered 2: BlendingLow 3: BlendingPrevious 4: BlendingNext 5: BlendingHigh	MC_Buffer_Mode	0 : mcAborting 1 : mcBuffered 2 : mcBlendingLow 3 : mcBlending_Previous 4 : mcBlending_Next 5 : mcBlending_High (0)	When <i>Ex_Move</i> changes to TRUE.

● Output Parameters

Parameter name	Function	Data type	Valid range
Invelocity	TRUE when the target velocity is reached.	BOOL	TRUE / FALSE
Stop_Done	TRUE when the stop position is reached.	BOOL	TRUE / FALSE
Busy	TRUE when the instruction is being executed.	BOOL	TRUE / FALSE
Active	TRUE when the axis is being controlled by the instruction.	BOOL	TRUE / FALSE
CommandAborted	TRUE when the instruction is aborted.	BOOL	TRUE / FALSE
Error	TRUE when there is an error in the execution of the instruction.	BOOL	TRUE / FALSE
ErrorID	Contains the error code when an error occurs. Please refer to section 12.2.	WORD	

● Output Update Timing

Name	Timing for changing to TRUE	Timing for changing to FALSE
Invelocity	◆ When the target velocity is reached.	◆ When <i>CommandAborted</i> changes to TRUE. ◆ When <i>Error</i> changes to TRUE. ◆ <i>Invelocity</i> changes to FALSE immediately when <i>Ex_Move</i> changes from FALSE to TRUE again if the input parameter values are revised after the target velocity is reached. If the input parameter values are not changed after the instruction execution is completed, <i>Invelocity</i> changes to FALSE immediately when <i>Ex_Move</i> changes from FALSE to TRUE again. <i>Invelocity</i> will change to TRUE in the next cycle.
Stop_Done	◆ When the stop position is reached	◆ When <i>CommandAborted</i> changes to TRUE. ◆ When <i>Error</i> changes to TRUE. ◆ When <i>Ex_Stop</i> changes to FALSE.
Busy	◆ When <i>Ex_Move</i> changes to TRUE.	◆ When <i>CommandAborted</i> changes to TRUE. ◆ When <i>Error</i> changes to TRUE.

Name	Timing for changing to TRUE	Timing for changing to FALSE
Active	◆ When the axis is being controlled by the instruction.	◆ When <i>CommandAborted</i> changes to TRUE. ◆ When <i>Error</i> changes to TRUE.
CommandAborted	◆ TRUE when the instruction is aborted by other motion instruction.	◆ When <i>Ex_Move</i> changes from TRUE to FALSE. ◆ <i>CommandAborted</i> is set to TRUE when the instruction is aborted after <i>Ex_Move</i> and <i>Ex_Stop</i> change from TRUE to FALSE during the instruction execution. One cycle later, <i>CommandAborted</i> changes to FALSE.
Error	◆ When an error occurs in the instruction execution or the input parameters for the instruction are illegal.	◆ When <i>Ex_Move</i> and <i>Ex_Stop</i> change from TRUE to FALSE.

● Output Update Timing Chart

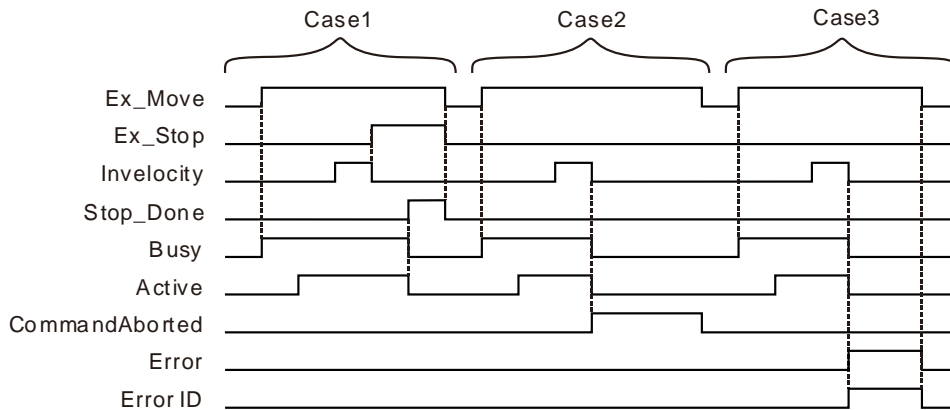

Case 1 : When *Ex_Move* changes from FALSE to TRUE, *Busy* changes to TRUE. When the axis starts being controlled by the instruction, *Active* changes to TRUE. When *Ex_Stop* changes from FALSE to TRUE, *Invelocity* changes to FALSE. When the position is reached, *Stop_Done* changes to TRUE and meanwhile, *Busy* and *Active* change to FALSE. When *Ex_Move* and *Ex_Stop* change from TRUE to FALSE, *Stop_Done* changes to FALSE.

Case 2 : When *Ex_Move* changes to TRUE, the instruction is aborted by other instruction and *CommandAborted* changes to TRUE. Meanwhile, *Invelocity*, *Busy* and *Active* change to FALSE. When *Ex_Move* changes from TRUE to FALSE, *CommandAborted* changes to FALSE.

Case 3 : When an error occurs while *Ex_Move* is TRUE, *Error* changes to TRUE and *ErrorID* shows corresponding error code. Meanwhile, *Invelocity*, *Busy* and *Active* change to FALSE. *Error* changes to FALSE when *Ex_Move* changes from TRUE to FALSE.

● Function

DMC_MoveVelocityStopByLinePos is used for making an axis stop at a specified position.

RoundPhase sets the specified modulo. **StopPhase** sets a position in the specified modulo. The value of **StopPhase** should be less than the value of **RoundPhase**. Their units are unit which is the same as that for the pitch (**UnitsPerRotation**).

As **Ex_Move** changes from FALSE to TRUE, the axis is controlled to run by the instruction. As **Ex_Stop** changes from FALSE to TRUE, the axis is controlled to stop at the position specified by **StopPhase**. The final position where the axis stops is the position of an integral multiple of **RoundPhase** value+ **StopPhase** value.

RoundPhase is set to 10000 and **StopPhase** is set to 4000 as shown in the figure below. And the terminal actuator can be controlled to stop at the position specified by **StopPhase** via the DMC_MoveVelocityStopByLinePos instruction.

The terminal actuator may stop at the position of 4000 units, 14000 units, 24000 units or 34000 units.

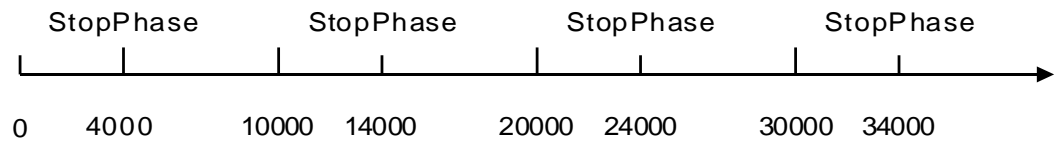

11.3.26 DMC_ReadPositionLagStatus

FB/FC	Explanation	Applicable model
FB	DMC_ReadPositionLagStatus is used for the detection of the position lag.	DVP15MC11T DVP15MC11T-06

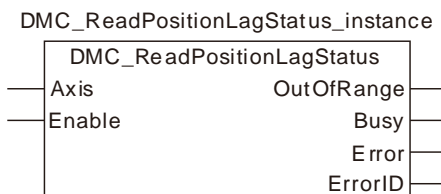

● **Input Parameters**

Parameter name	Function	Data type	Valid range (Default)	Validation timing
Axis	Specify the number of the axis which is to be controlled.	USINT	Refer to Functions of Section 2.2. (The variable value must be set)	When <i>Enable</i> is TRUE.
Enable	The instruction is executed when <i>Enable</i> changes from FALSE to TRUE.	BOOL	TRUE or FALSE (FALSE)	When <i>Enable</i> is TRUE.

● **Output Parameters**

Parameter name	Function	Data type	Valid range
OutOfRange	TRUE when the position lag is out of the valid range.	BOOL	TRUE/FALSE
Busy	TRUE when the instruction is being executed.	BOOL	TRUE / FALSE
Error	TRUE when there is an error in the execution of the instruction.	BOOL	TRUE / FALSE
ErrorID	Contains the error code when an error occurs. Please refer to section 12.2.	WORD	

● **Output Update Timing**

Name	Timing for changing to TRUE	Timing for changing to FALSE
OutOfRange	◆ When the absolute value of the actual position difference of the specified axis has been exceeding the set <i>Lag</i> value within the <i>HoldTime</i> period since it exceeded the <i>Lag</i> value for the first time.	◆ The absolute value of the actual position difference of the specified axis is less than or equal to the <i>Lag</i> value. ◆ When <i>Enable</i> is FALSE. ◆ When <i>Error</i> changes to TRUE.
Busy	◆ When the instruction is being executed.	◆ When <i>Error</i> changes to TRUE.
Error	◆ When an error occurs in the instruction execution or the input parameters for the instruction are illegal.	◆ When the problem is solved.

● **Function**

DMC_ReadPositionLagStatus is used to detect if the absolute value of actual position difference of the specified axis (which is the difference between the command position and feedback position) exceeds the setting value. The allowed position difference value is set in the DMC_WritePositionLagSetting instruction.

The *OutOfRange* output will change to TRUE if the actual position difference of the specified axis has been exceeding the *Lag* value within the period specified by *HoldTime* since the *Lag* value was exceeded for the first time. (*Lag* and *HoldTime* are the inputs of DMC_WritePositionLagSetting.) The *OutOfRange* output will change to FALSE when the absolute value of the actual position difference of the specified axis is less than or equal to the *Lag* value.

When the setting value of *HoldTime* of DMC_WritePositionLagSetting is 0, the *OutOfRange* output will change to TRUE once the instruction detects that the actual position difference of the specified axis exceeds the *Lag* value and the *OutOfRange* output will change to FALSE once the instruction detects that the absolute value of the actual position difference of the specified axis is less than or equal to the *Lag* value.

The axis will not stop running when the instruction detects that the actual position difference of the specified axis exceeds the *Lag* value. The running of the axis can be stopped by triggering the execution of MC_Stop or MC_Halt instruction via the *OutOfRange* output.



Programming Example

1. The variable table and program

Variable name	Data type	Initial value
DWPLS	DMC_WritePositionLagSetting	
DWPLS_Ex	BOOL	
DWPLS_Lag	LREAL	
DWPLS_H_Time	LREAL	
DWPLS_Done	BOOL	
DWPLS_Bsy	BOOL	
DWPLS_Err	BOOL	
DWPLS_ErrID	WORD	
DRPLS	DMC_ReadPositionLagStatus	
DRPLS_OutfRge	BOOL	
DRPLS_Bsy	BOOL	
DRPLS_Err	BOOL	
DRPLS_ErrID	WORD	
MStop	MC_Stop	
Mstop_DEC	LREAL	
Mstop_Jerk	LREAL	
Mstop_Done	BOOL	
Mstop_Bsy	BOOL	
Mstop_Act	BOOL	
Mstop_Abt	BOOL	
Mstop_Err	BOOL	
Mstop_ErrID	WORD	

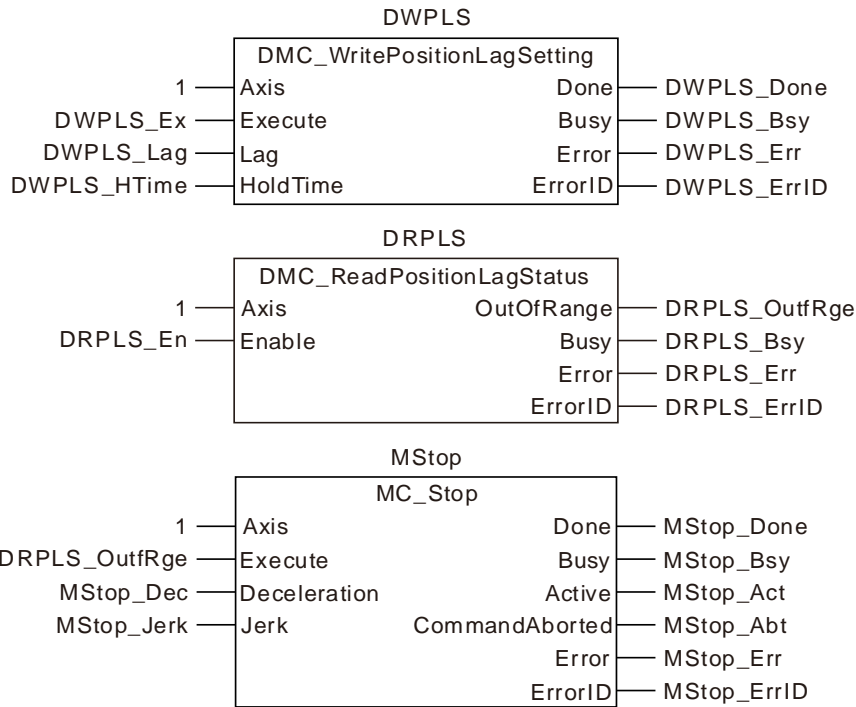

- ❖ When DWPLS_Exec changes from FALSE to TRUE, set the position difference value specified by *Lag* and the duration value specified by *HoldTime* for the specified axis. When DWPLS_Done changes to TRUE, it indicates that the parameters writing is completed.
- ❖ When DRPLS_En changes to TRUE, the DMC_ReadPositionLagStatus instruction begins to detect whether the actual position difference of the specified axis exceeds the allowed value set in the DMC_WritePositionLagSetting instruction.
 The DRPLS_OutfRge changes to TRUE when the DMC_ReadPositionLagStatus instruction detects that the actual position difference of the specified axis exceeds the setting value and then continues to exceed the setting value within the set period of time.
 The axis can stop running by triggering the execution of the MC_Stop instruction via the DRPLS_OutfRge output.
 DRPLS_OutfRge changes to FALSE when the DMC_ReadPositionLagStatus instruction detects that the actual position difference of the specified axis is less than the setting value.

11.3.27 DMC_WritePositionLagSetting

FB/FC	Explanation	Applicable model
FB	DMC_WritePositionLagSetting is used for setting the position lag.	DVP15MC11T DVP15MC11T-06

DMC_WritePositionLagSetting_instance

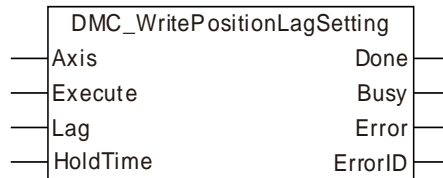

● Input Parameters

Parameter name	Function	Data type	Valid range (Default)	Validation timing
Axis	Specify the number of the axis which is to be controlled.	USINT	Refer to Functions of Section 2.2. (The variable value must be set)	When <i>Execute</i> changes from FALSE to TRUE.
Execute	The instruction is executed when <i>Execute</i> changes from FALSE to TRUE.	BOOL	TRUE or FALSE (FALSE)	-
Lag	Set the allowed value of the difference between the command position and feedback position.	LREAL	Positive number (The variable value must be set)	When <i>Execute</i> changes from FALSE to TRUE.
HoldTime	A period of time during which the set <i>Lag</i> value is exceeded. (Unit: second)	LREAL	0 or Positive number (0)	When <i>Execute</i> changes from FALSE to TRUE.

● Output Parameters

Parameter name	Function	Data type	Valid range
Done	TRUE when the instruction execution is completed.	BOOL	TRUE/FALSE
Busy	TRUE when the instruction is being executed.	BOOL	TRUE/FALSE
Error	TRUE when there is an error in the execution of the instruction.	BOOL	TRUE/FALSE
ErrorID	Contains the error code when an error occurs. Please refer to section 12.2.	WORD	

● Output Update Timing

Name	Timing for changing to TRUE	Timing for changing to FALSE
Done	◆ When the instruction execution is completed.	◆ When <i>Execute</i> changes to FALSE. ◆ When <i>Error</i> changes to TRUE.
Busy	◆ When the instruction is being executed.	◆ When <i>Error</i> changes to TRUE.
Error	◆ When an error occurs in the instruction execution or the input parameters for the instruction are illegal.	◆ When the error is cleared.

● **Function**

DMC_WritePositionLagSetting is used to set the allowed position lag value (which is the difference between the command position and feedback position) and the allowed length of time specified by *HoldTime* during which the setting value of *Lag* is exceeded. Whether the actual position difference of a specified axis exceeds the setting value of *Lag* or not is detected by the DMC_ReadPositionLagStatus instruction.

For further explanation and example, refer to the section of DMC_ReadPositionLagStatus instruction.

11.3.28 DMC_ChangeMechanismGearRatio

FB/FC	Explanation	Applicable model
FB	DMC_ChangeMechanismGearRatio is used for modifying axis parameter values.	DVP15MC11T DVP15MC11T-06

DMC_ChangeMechanismGearRatio_instance

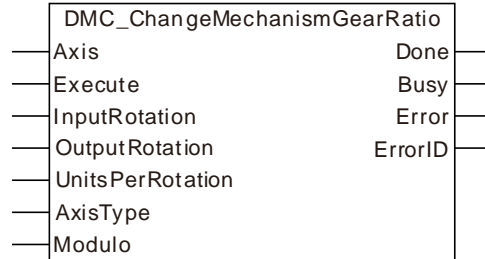

● Input Parameters

Parameter name	Function	Data type	Valid range (Default)	Validation timing
Axis	Specify the number of the axis which is to be controlled.	USINT	Refer to Functions of Section 2.2. (The variable value must be set)	When <i>Execute</i> changes from FALSE to TRUE.
Execute	The instruction is executed when <i>Execute</i> changes from FALSE to TRUE.	BOOL	TRUE or FALSE (FALSE)	-
InputRotation	This parameter and <i>OutputRotation</i> decide the mechanical gear ratio.	LREAL	Positive integer (The variable value must be set)	When <i>Execute</i> changes from FALSE to TRUE.
OutputRotation	<i>InputRotation</i> and this parameter and decide the mechanical gear ratio.	LREAL	Positive integer (The variable value must be set)	When <i>Execute</i> changes from FALSE to TRUE.
UnitsPerRotation	The number of units which the terminal actuator moves while output end of the gear box rotates for a circle. (Unit: units/rotation)	LREAL	Positive number (The variable value must be set)	When <i>Execute</i> changes from FALSE to TRUE.
AxisType	Axis type 0: rotary axis 1: linear axis	USINT	0, 1 (0)	When <i>Execute</i> changes from FALSE to TRUE.
Modulo	The cycle used for equally dividing the actual position of the terminal actuator.	LREAL	Positive number (The variable value must be set)	When <i>Execute</i> changes from FALSE to TRUE.

● Output Parameters

Parameter name	Function	Data type	Valid range
Done	TRUE when the instruction execution is completed.	BOOL	TRUE/FALSE
Busy	TRUE when the instruction is being executed.	BOOL	TRUE / FALSE
Error	TRUE when there is an error in the execution of the instruction.	BOOL	TRUE / FALSE

Parameter name	Function	Data type	Valid range
ErrorID	Contains the error code when an error occurs. Please refer to section 12.2.	WORD	

● **Output Update Timing**

Name	Timing for changing to TRUE	Timing for changing to FALSE
Done	◆ When the instruction execution is completed.	◆ When <i>Error</i> changes to TRUE. ◆ When <i>Execute</i> changes to FALSE.
Busy	◆ When <i>Execute</i> changes to TRUE.	◆ When <i>Error</i> changes to TRUE.
Error	◆ When an error occurs in the instruction execution or the input parameters for the instruction are illegal.	◆ When <i>Execute</i> changes from TRUE to FALSE.

● **Output Update Timing Chart**

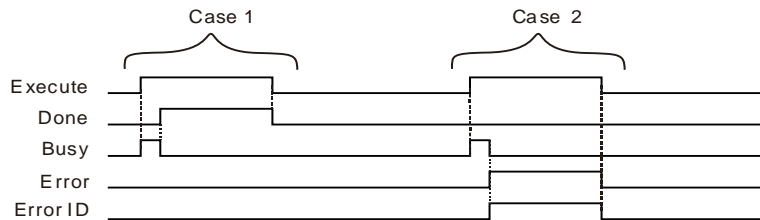

Case 1 : When *Execute* changes from FALSE to TRUE, *Busy* changes to TRUE. When the instruction execution is completed, *Done* changes to TRUE and *Busy* changes to FALSE. When *Execute* changes to FALSE, *Done* changes to FALSE.

Case 2 : When an error occurs, *Error* changes to TRUE and *ErrorID* shows corresponding error code. When *Execute* changes from TRUE to FALSE, *Error* changes to FALSE and the value of *ErrorID* is cleared to 0.

● **Function**

DMC_ChangeMechanismGearRatio is used for modifying parameter values for the terminal actuator. The instruction can change axis parameter values so as to make them consistent with actual parameter values, which is more convenient for users to operate.

The instruction can be executed only when the axis is in Disabled or Standstill state.

11.3.29 DMC_TorqueControl

FB/FC	Explanation	Applicable model
FB	DMC_TorqueControl controls an axis to work under torque mode and carry out the torque output.	DVP15MC11T DVP15MC11T-06

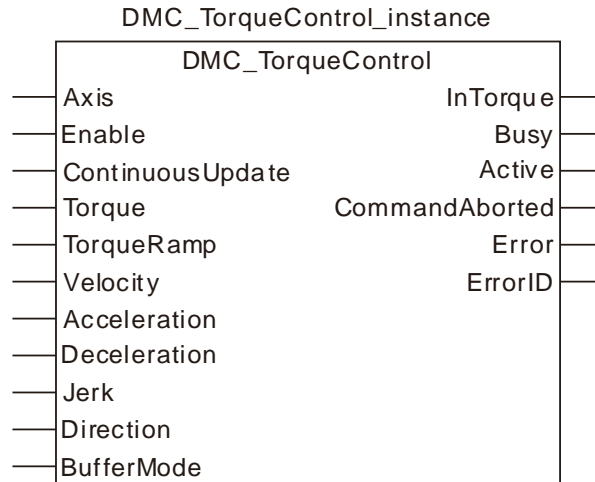

● Input Parameters

Parameter name	Function	Data type	Valid range (Default)	Validation timing
Axis	Specify the number of the axis which is to be controlled.	USINT	Refer to Functions of Section 2.2. (The variable value must be set)	When <i>Enable</i> changes to TRUE.
Enable	The instruction is executed when <i>Enable</i> changes from FALSE to TRUE.	BOOL	TRUE or FALSE (FALSE)	When <i>Enable</i> changes to TRUE.
ContinuousUpdate	Reserved	-	-	-
Torque	Specify the target torque. The torque is expressed with the permillage of rated torque of the servo axis. For instance, the setting value 30 indicates that the set torque is 30‰ of rated torque of the servo axis. While <i>Enable</i> changes to TRUE, modifying the parameter value will make the torque changed immediately.	INT	Negative number, positive number, 0 (0)	When <i>Enable</i> changes to TRUE.
TorqueRamp	Specify change rate of the torque from current torque to target torque. (Unit: ‰/s)	LREAL	Negative number, positive number (The variable value must be set)	When <i>Enable</i> changes from FALSE to TRUE.
Velocity	When the torque control instruction controls an axis, the velocity of the axis cannot exceed the setting value. (Unit: unit/s)	LREAL	Positive number (The variable value must be set)	When <i>Enable</i> changes from FALSE to TRUE.

Parameter name	Function	Data type	Valid range (Default)	Validation timing
Acceleration	Reserved			
Deceleration	Reserved			
Jerk	Reserved			
Direction	Specify the rotation direction for the axis. 1: Positive direction 3: Negative direction	MC_Direction	1: mcPositiveDirection, 3: mcNegativeDirection (The variable value must be set)	When <i>Enable</i> changes from FALSE to TRUE.
BufferMode	Reserved			

● Output Parameters

Parameter name	Function	Data type	Valid range
InTorque	TRUE when the set target torque is reached.	BOOL	TRUE / FALSE
Busy	TRUE when the instruction is being executed.	BOOL	TRUE / FALSE
Active	TRUE when the axis is being controlled.	BOOL	TRUE / FALSE
CommandAborted	TRUE when the instruction is aborted.	BOOL	TRUE / FALSE
Error	TRUE when an error occurs in execution of the instruction.	BOOL	TRUE / FALSE
ErrorID	Contains the error code when an error occurs. Please refer to section 12.2 for the corresponding error ID.	WORD	

● Output Update Timing

Name	Timing for changing to TRUE	Timing for changing to FALSE
InTorque	◆ When the target torque is reached.	◆ When <i>Error</i> changes to TRUE. ◆ When <i>Enable</i> changes from TRUE to FALSE.
Busy	◆ When <i>Enable</i> changes to TRUE.	◆ When <i>InTorque</i> changes to TRUE. ◆ When <i>Error</i> changes to TRUE.
Active	◆ When the instruction starts to control the axis.	◆ When <i>InTorque</i> changes to TRUE. ◆ When <i>Error</i> changes to TRUE.
CommandAborted	◆ When this instruction execution is aborted by other motion control instruction.	◆ When <i>Enable</i> changes from TRUE to FALSE. ◆ <i>CommandAborted</i> is set to TRUE when the instruction is aborted by other instruction after <i>Enable</i> changes from TRUE to FALSE during the instruction execution. One cycle later, <i>CommandAborted</i> changes to FALSE.
Error	◆ When an error occurs in the instruction execution or the input parameters for the instruction are illegal.	◆ When <i>Enable</i> changes from TRUE to FALSE.

● Output Update Timing Chart

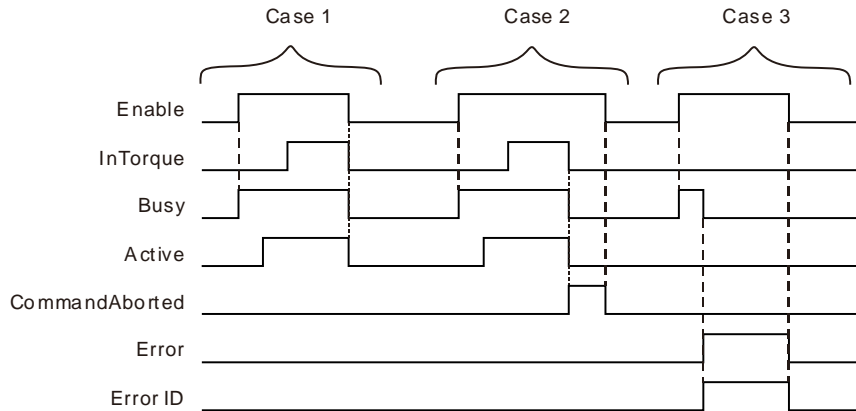

- Case 1 :** When *Enable* changes from FALSE to TRUE, *Busy* changes to TRUE. When the instruction starts to control the axis, *Active* changes to TRUE. *InTorque* changes to TRUE when the set target torque is reached. When *Enable* changes from TRUE to FALSE, *Busy*, *Active* and *InTorque* change to FALSE.
- Case 2 :** When the instruction is aborted by MC_Stop after *Enable* changes from FALSE to TRUE, *CommandAborted* changes to TRUE and meanwhile *InTorque*, *Busy* and *Active* change to FALSE. When *Enable* changes from TRUE to FALSE, *CommandAborted* changes to FALSE.
- Case 3 :** The input parameter is illegal (such as axis number: 0) before the instruction is executed. When *Enable* changes from FALSE to TRUE, *Busy* changes to TRUE and one cycle later, *Error* changes to TRUE, *Busy* changes to FALSE and *ErrorID* shows corresponding error codes. When *Enable* changes from TRUE to FALSE, *Error* changes from TRUE to FALSE and the value of *ErrorID* is cleared to 0.

● Function

DMC_TorqueControl controls an axis to work under torque mode and carry out the torque output. Based on the set change rate of the torque, axis motion will change in the process from current torque to target torque. If the torque value is modified during the execution of the instruction, the torque of the servo will immediately change according to the change rate of the torque and then the servo will keep the torque value for motion. During the execution of the instruction, the instruction will control the velocity of the axis not to exceed the set maximum velocity.

To stop the instruction, change *Enable* to FALSE or use MC_Stop to make the instruction aborted. When *Enable* changes from TRUE to FALSE, the axis will exit from the torque mode and the torque will change immediately (the change rate of the torque will be invalid). If the axis needs to stop gradually according to the change rate of the torque, just set the target torque to 0, wait for the actual output torque of the axis to change to 0 and then change *Enable* to FALSE.



Programming Example

2. The variable table and program

Variable name	Data type	Initial value
Pwr	MC_Power	
Axis1	USINT	1
Pwr_En	BOOL	FALSE
Pwr_EnPs	BOOL	FALSE
Pwr_BM	MC_Buffer_Mode	0
Pwr_Sta	BOOL	
Pwr_Bsy	BOOL	
Pwr_Act	BOOL	
Pwr_Err	BOOL	

Variable name	Data type	Initial value
Pwr_ErrID	WORD	
TC	DMC_TorqueControl	
TC_En	BOOL	FALSE
TC_Tor	INT	30
TC_TorRa	LREAL	5.0
TC_Vel	LREAL	100000.0
TC_Dir	MC_Direction	1
TC_InTor	BOOL	
TC_Bsy	BOOL	
TC_Act	BOOL	
TC_Abt	BOOL	
TC_Err	BOOL	
TC_ErrID	WORD	

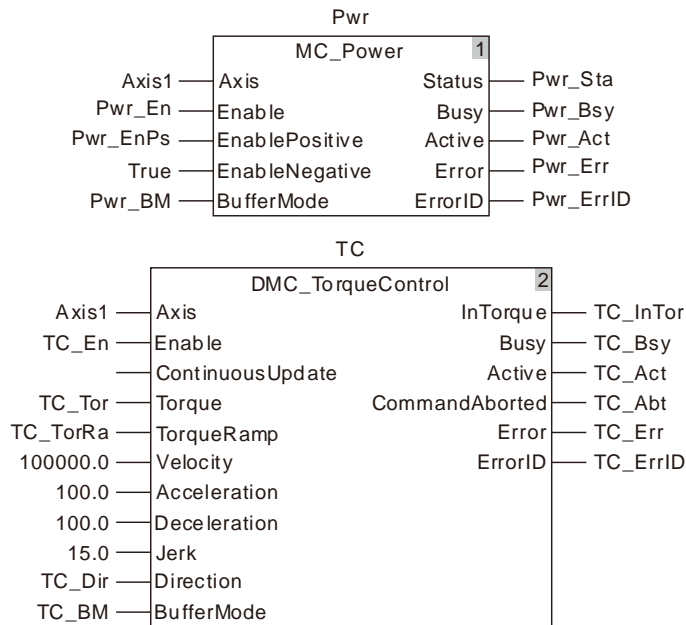

3. Motion Curve and Timing Chart

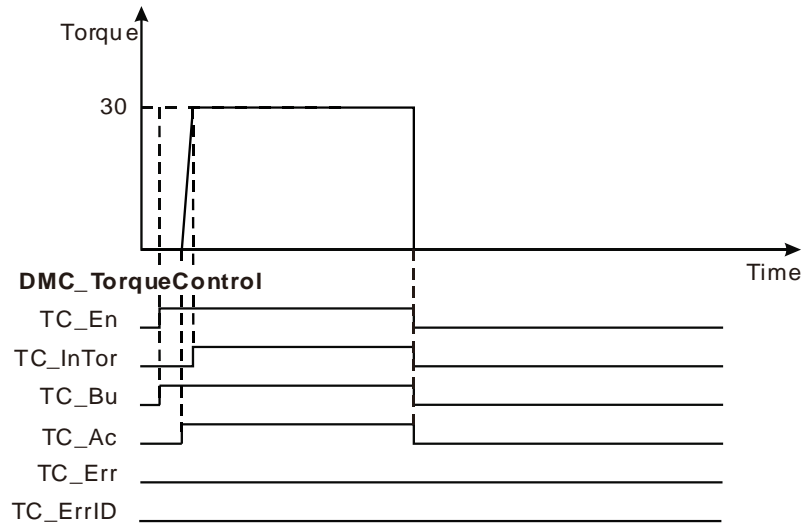

- ❖ When TC_En changes from FALSE to TRUE, DMC_TorqueControl is executed. Meanwhile TC_Bsy changes from FALSE to TRUE. When TC_Act changes to TRUE, the instruction starts to control the axis and the torque value will be increased according to the set change rate of the torque.
- ❖ After the value of TC_Tor is set to 0, the torque value is decreased to 0 according to the set change rate of the torque.
- ❖ When TC_En changes from TRUE to FALSE, TC_InTor, TC_Bsy and TC_Act change from FALSE to TRUE and the servo exits from the torque mode.

11.3.30 DMC_MoveVelocity

FB/FC	Explanation	Applicable model
FB	DMC_MoveVelocity changes the parameter values of the velocity instruction to make the controlled axis valid immediately during execution of the velocity instruction.	DVP15MC11T DVP15MC11T-06

11

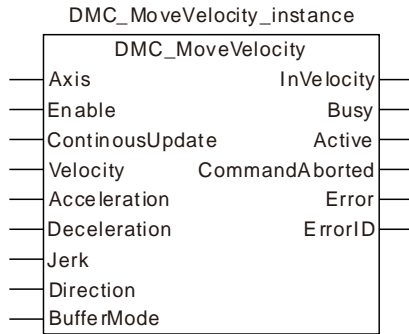

● **Function**

DMC_MoveVelocity changes the velocity and makes the axis velocity valid immediately during execution of the velocity instruction. The function of the instruction is similar to MC_MoveVelocity instruction. The only difference between the two instructions is that changing the values of *Velocity*, *Acceleration*, *Deceleration*, *Jerk* and *Direction* of the instruction will take effect immediately as *Enable* is TRUE. For details on parameters and data types, refer to MC_MoveVelocity.

11.3.31 DMC_SwitchSoftLimit

FB/FC	Explanation	Applicable model
FB	DMC_SwitchSoftLimit controls the software limit switch.	DVP15MC11T DVP15MC11T-06

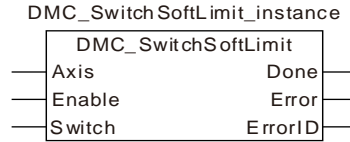

● Input Parameters

Parameter name	Function	Data type	Valid range (Default)	Validation timing
Axis	Specify the number of the axis which is to be controlled.	USINT	Refer to Functions of Section 2.2. (The variable value must be set)	When <i>Enable</i> changes to TRUE.
Enable	The instruction is executed when <i>Enable</i> changes from FALSE to TRUE.	BOOL	TRUE or FALSE (FALSE)	When <i>Enable</i> changes to TRUE.
Switch	FALSE: Turn the software limit switch OFF. TRUE: Turn the software limit switch ON.	BOOL	TRUE or FALSE (FALSE)	When <i>Enable</i> changes to TRUE.

● Output Parameters

Parameter name	Function	Data type	Valid range
Done	TRUE when the instruction execution is completed.	BOOL	TRUE / FALSE
Error	TRUE when an error occurs in execution of the instruction.	BOOL	TRUE / FALSE
ErrorID	Contains the error code when an error occurs. Please refer to section 12.2.	WORD	-

● Output Update Timing

Parameter Name	Timing for changing to TRUE	Timing for changing to FALSE
Done	◆ When the instruction execution is completed.	◆ When <i>Error</i> changes to TRUE. ◆ When <i>Enable</i> changes from TRUE to FALSE.
Error	◆ The input parameters for the instruction are illegal.	◆ When <i>Enable</i> changes from TRUE to FALSE.

● Function

DMC_SwitchSoftLimit controls the software limit switch. When *Switch* is TRUE and the instruction execution is completed, the software limit switch turns ON. When *Switch* is FALSE and the instruction execution is completed, the software limit switch turns OFF.

Also, users could set the switch by clicking Network Configuration-> Motion->Axis Configuration->General in the software without using the instruction.

The maximum position and minimum position need be set through the software.

After the software limit switch is ON, an error will occur if the axis position which is being controlled by motion instructions exceeds the software limit range.

 **Programming Example**

■ **The variable table and program**

11

Variable name	Data type	Initial value
SSL	DMC_SwitchSoftLimit	
Axis1	USINT	1
SSL_En	BOOL	FALSE
SSL_Swh	BOOL	FALSE
SSL_Done	BOOL	
SSL_Err	BOOL	
SSL_ErrID	WORD	

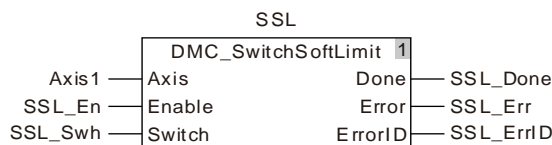

- ❖ When SSL_Swh is TRUE and SSL_En changes from FALSE to TRUE, the instruction is executed. When the instruction execution is completed, SSL_Done changes to TRUE and the number 1 software limit switch is enabled.
- ❖ When SSL_Swh is FALSE and SSL_En changes from FALSE to TRUE, the instruction is executed. When the instruction execution is completed, SSL_Done changes to TRUE and the number 1 software limit switch is disabled.

11.4 Multi-axis Instructions

11.4.1 MC_GearIn

FB/FC	Explanation	Applicable model
FB	MC_GearIn is used for establishing the electronic gear relationship between two axes.	DVP15MC11T DVP15MC11T-06

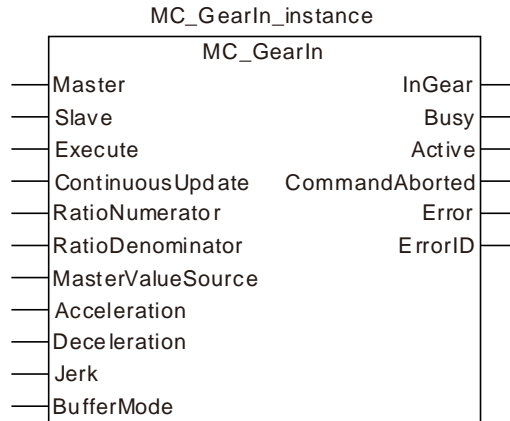

● Input Parameters

Parameter name	Function	Data type	Valid range (Default)	Validation timing
Master	Specify the number of the master axis which is to be controlled by the instruction	USINT	Refer to Functions of Section 2.2. (The variable value must be set)	When <i>Execute</i> changes from FALSE to TRUE
Slave	Specify the number of the slave axis which is to be controlled by the instruction	USINT	Refer to Functions of Section 2.2. (The variable value must be set)	When <i>Execute</i> changes from FALSE to TRUE
Execute	The instruction is executed when <i>Execute</i> changes from FALSE to TRUE.	BOOL	TRUE or FALSE (FALSE)	-
ContinuousUpdate	Reserved	-	-	-
RatioNumerator	Gear ratio Numerator	LREAL	Positive number and negative number (The variable value must be set)	When <i>Execute</i> changes from FALSE to TRUE
RatioDenominator	Gear ratio Denominator	LREAL	Positive number (The variable value must be set)	When <i>Execute</i> changes from FALSE to TRUE
MasterValueSource	Command source selection 0 : Command position of the master axis which the slave axis follows 1 : Actual position of the master axis which the slave axis follows	MC_Sourc e	0:mcSetValue 1:mcActualValue (0)	When <i>Execute</i> changes from FALSE to TRUE
Acceleration	Specify the target acceleration. (Unit: Unit/s ²)	LREAL	Positive number (The variable value must be set)	When <i>Execute</i> changes from FALSE to TRUE
Deceleration	Specify the target	LREAL	Positive number	When <i>Execute</i>

Parameter name	Function	Data type	Valid range (Default)	Validation timing
	deceleration. (Unit: Unit/s ²)		(The variable value must be set)	changes from FALSE to TRUE
Jerk	Specify the change rate of target acceleration and deceleration. (Unit: Unit/s ³)	LREAL	Positive number (The variable value must be set)	When <i>Execute</i> changes from FALSE to TRUE
BufferMode	Specify the behavior when executing two instructions. 0: Aborting 1: Buffered	MC_Buffer _ Mode	0 : mcAborting 1 : mcBuffered (0)	When <i>Execute</i> changes from FALSE to TRUE

Notes:

1. The execution of MC_GearIn is started when *Execute* changes from FALSE to TRUE. No matter whether the execution of the instruction is completed or not, the instruction can be re-executed when *Execute* changes from FALSE to TRUE once again. During re-execution, only *RatioNumerator*, *RatioDenominator*, *MasterValueSource*, *Acceleration*, *Deceleration* and *Jerk* parameters will be effective again.
2. The slave axis specified by MC_GearIn instruction can execute other motion instruction while MC_GearIn is being executed. While other motion instruction aborts the MC_GearIn instruction, the gear relationship between the master axis and slave axis will disconnected. MC_Halt or MC_Stop can abort the motion of the slave axis.
3. Refer to section 10.2 for the relation among *Acceleration*, *Deceleration* and *Jerk*.
4. Refer to section 10.3 for details on *BufferMode*.

● **Output Parameters**

Parameter name	Function	Data type	Valid range
InGear	TRUE when the slave axis reaches the synchronous state.	BOOL	TRUE / FALSE
Busy	TRUE when the instruction is being executed.	BOOL	TRUE / FALSE
Active	TRUE when the axis is being controlled.	BOOL	TRUE / FALSE
CommandAborted	TRUE when the instruction is aborted.	BOOL	TRUE / FALSE
Error	TRUE when there is an error in the execution of the instruction.	BOOL	TRUE / FALSE
ErrorID	Contains the error code when an error occurs. Please refer to section 12.2.	WORD	

● **Output Update Timing**

Name	Timing for changing to TRUE	Timing for changing to FALSE
InGear	◆ When the slave axis enters the synchronous state.	<ul style="list-style-type: none"> ◆ When <i>CommandAborted</i> changes to TRUE ◆ When <i>Error</i> changes to TRUE ◆ <i>InGear</i> will change to FALSE immediately when the input parameter is modified after the synchronous state is reached and <i>Execute</i> changes from FALSE to TRUE once more. ◆ <i>InGear</i> will change to FALSE immediately when the input parameter is not modified after the instruction execution is finished and <i>Execute</i> changes from FALSE to TRUE once more. And in the next period, <i>InGear</i> changes to TRUE.
Busy	◆ When <i>Execute</i> changes to TRUE	<ul style="list-style-type: none"> ◆ When <i>CommandAborted</i> changes to TRUE ◆ When <i>Error</i> changes to TRUE

Name	Timing for changing to TRUE	Timing for changing to FALSE
Active	◆ When the axis starts being controlled by the instruction	◆ When <i>CommandAborted</i> changes to TRUE ◆ When <i>Error</i> changes to TRUE
CommandAborted	◆ When the instruction execution is aborted by other motion instruction	◆ When <i>Execute</i> changes from TRUE to FALSE ◆ <i>CommandAborted</i> is set to TRUE when the instruction is aborted by other instruction after <i>Execute</i> changes from TRUE to FALSE in the course of the instruction execution. One period later, <i>CommandAborted</i> changes to FALSE.
Error	◆ When an error occurs in the instruction execution or the input parameters for the instruction are illegal	◆ When <i>Execute</i> changes from TRUE to FALSE

● Output Update Timing Chart

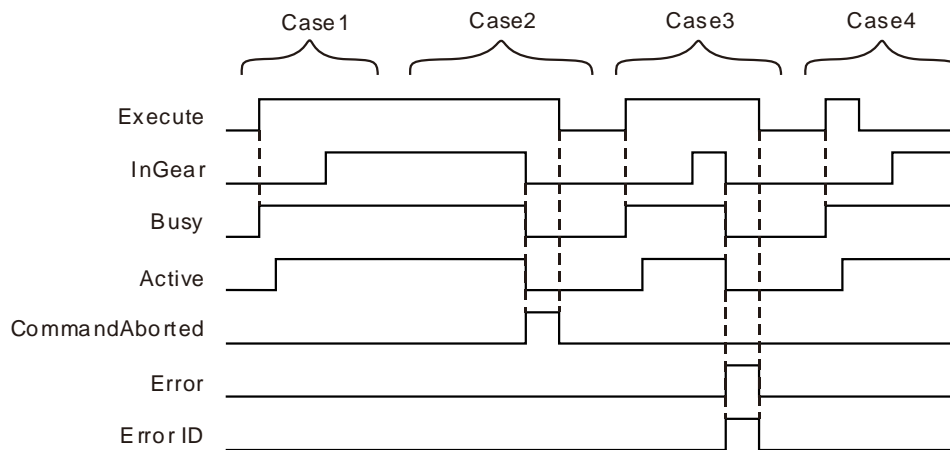

Case 1 : *Busy* changes to TRUE as *Execute* changes from FALSE to TRUE. One period later, *Active* changes to TRUE. When the synchronous state is reached, *InGear* changes to TRUE and meanwhile *Busy* and *Active* remain TRUE.

Case 2 : When *Execute* changes to TRUE and the slave axis is controlled by other instruction, MC_GearIn instruction is aborted by other instruction and *CommandAborted* changes to TRUE. Meanwhile *Busy* and *Active* change to FALSE. When *Execute* changes from TRUE to FALSE, *CommandAborted* changes to FALSE.

Case 3 : When *Execute* changes from FALSE to TRUE and an error such as a parameter mistake occurs, *Error* changes to TRUE and *ErrorID* shows corresponding error codes. Meanwhile *InGear*, *Busy* and *Active* change to FALSE. As *Execute* changes from TRUE to FALSE, *Error* changes to FALSE.

Case 4 : After *Execute* changes from TRUE to FALSE in the process of execution of MC_GearIn, *InGear* changes to TRUE and meanwhile *Busy* and *Active* remain TRUE.

● Function

1. MC_GearIn is used for establishing an electronic gear relationship between two axes. After the MC_GearIn instruction is executed, the slave axis performs the gear operation with the master axis according to the parameters, *RatioNumerator*, *RatioDenominator*, *Acceleration*, *Deceleration*, *Jerk* and *BufferMode*. The master axis can be a real axis, virtual axis or encoder axis. The slave axis can be a real axis or virtual axis.
2. In the instruction execution, the slave axis need be enabled and the master axis can be enabled or disabled.

- If the MC_GearIn instruction is executed when the e-gear relationship between two axes has not been built yet, the velocity of the slave axis will reach the target velocity according to the values of *RatioNumerator*, *RatioDenominator*, *Acceleration*, *Deceleration* and *Jerk* specified by the instruction.

$$\text{Acceleration (or Deceleration) of Slave axis} = \text{Acceleration (or Deceleration) of Master axis} \times \frac{\text{RatioNumerator}}{\text{RatioDenominator}}$$

After the e-gear relationship between two axes has been built (when *InGear* of the instruction changes to TRUE), the relationship among the velocity of the slave axis, gear ratio numerator, gear ratio denominator and the velocity of the master axis is shown as below.

$$\text{Target velocity of Slave axis} = \text{Velocity of Master axis} \times \frac{\text{Gear ratio numerator}}{\text{Gear ratio denominator}}$$

- E-gear ratio

$$\text{E-gear ratio} = \frac{\text{RatioNumerator}}{\text{RatioDenominator}}$$

If the e-gear ratio is a positive number, the motion directions of the slave axis and master axis are same.

If the e-gear ratio is a negative number, the motion directions of the slave axis and master axis are opposite.



Programming Example

Below is the example of execution of MC_GearIn instructions.

1. The variable table and program

Variable name	Data type	Initial value
Vel	MC_MoveVelocity	
Axis1	USINT	1
Axis2	USINT	2
Vel_Ex	BOOL	FALSE
Vel_Dir	MC_DIRECTION	1
Vel_BM	MC_Buffer_Mode	0
Vel_Invel	BOOL	
Vel_Bsy	BOOL	
Vel_Act	BOOL	
Vel_Abt	BOOL	
Vel_Err	BOOL	
Vel_ErrID	WORD	
GearIn1	MC_GearIn	
GearIn1_Ex	BOOL	FALSE
GearIn1_BM	MC_Buffer_Mode	0
GearIn1_InGear	BOOL	
GearIn1_Bsy	BOOL	
GearIn1_Act	BOOL	
GearIn1_Abt	BOOL	
GearIn1_Err	BOOL	
GearIn1_ErrID	WORD	
GearIn2	MC_GearIn	
GearIn2_Ex	BOOL	FALSE
GearIn2_BM	MC_Buffer_Mode	0
GearIn2_InGear	BOOL	

Variable name	Data type	Initial value
GearIn2_Bsy	BOOL	
GearIn2_Act	BOOL	
GearIn2_Abt	BOOL	
GearIn2_Err	BOOL	
GearIn2_ErrID	WORD	

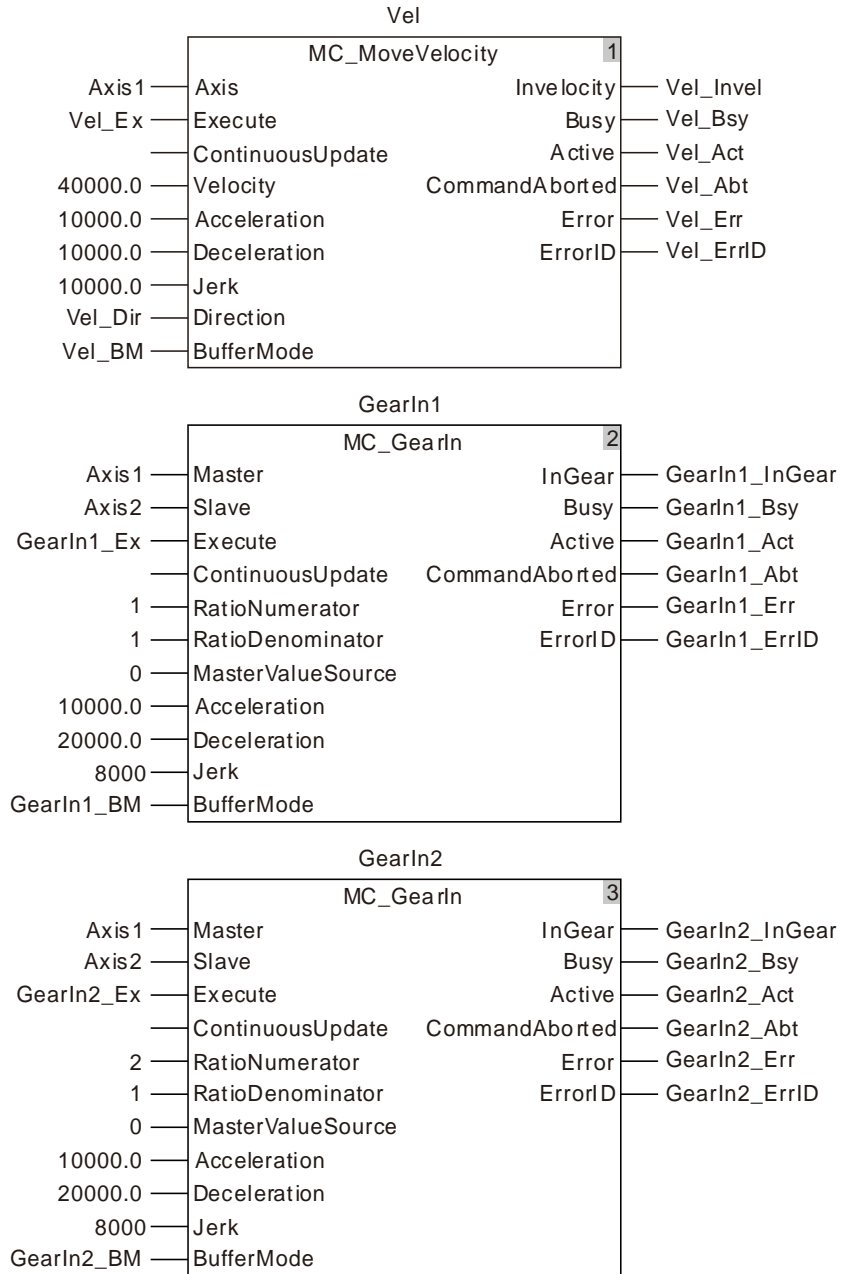

3. Motion Curve and Timing Charts:

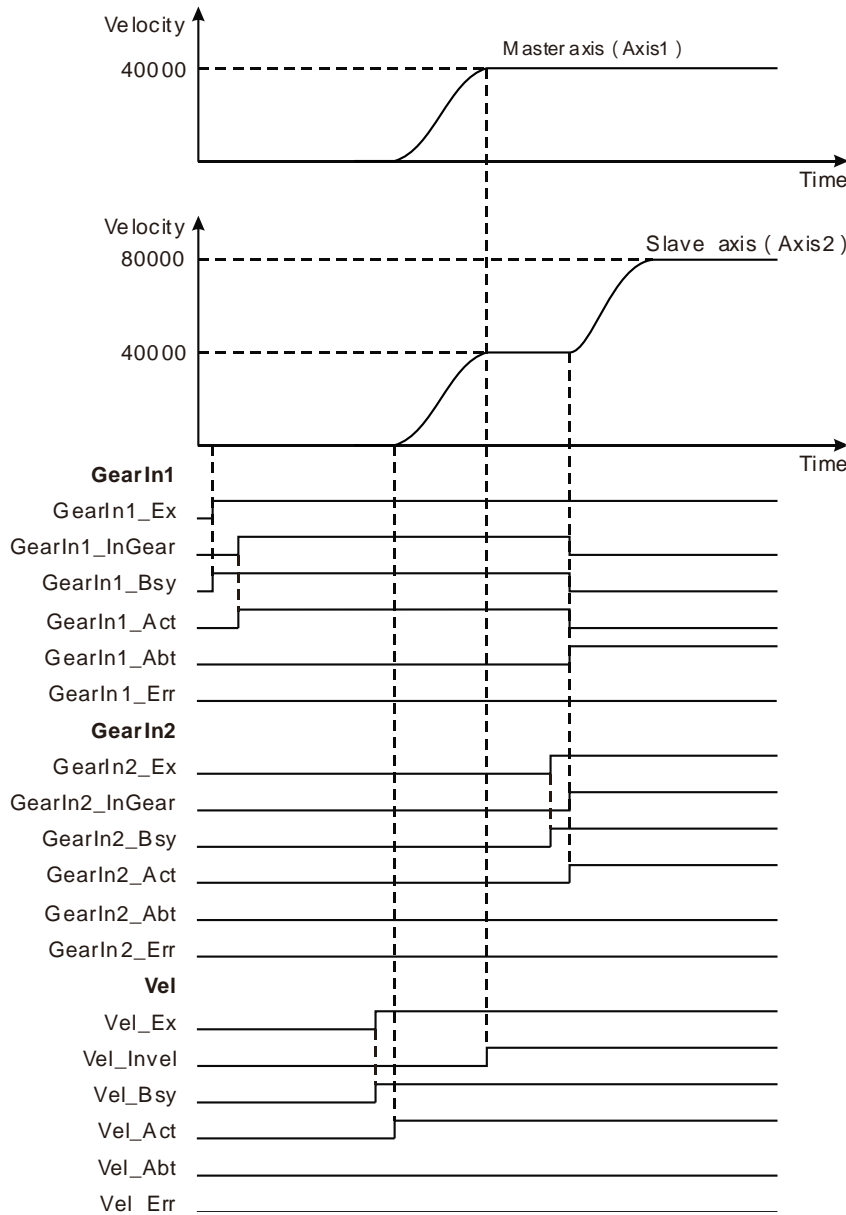

- ❖ In GearIn1, the values of *RatioNumerator* and *RatioDenominator* are both 1. GearIn1_Ex changes from FALSE to TRUE and meanwhile GearIn1_Bsy changes to TRUE. One period later, GearIn1_InGear changes to TRUE and the e-gear relationship between the master axis and the slave axis is built.
- ❖ Vel_Ex changes from FALSE to TRUE after the e-gear relationship between the master axis and slave axis is built. One period later, Vel_Act changes to TRUE, the master axis performs the velocity instruction and the slave axis follows the master axis for motion.
- ❖ In GearIn2, the values of *RatioNumerator* and *RatioDenominator* are 2 and 1 respectively. GearIn2_Ex changes from FALSE to TRUE and meanwhile GearIn2_Bsy changes to TRUE. One period later, GearIn2_Act and GearIn1_Abt change to TRUE and the slave axis gets to the target velocity based on the values of *RatioNumerator*, *Ratio Denominator*, *MasterValueSource*, *Acceleration*, *Jerk* and *BufferMode* specified by the GearIn2 instruction. Since the values of *RatioNumerator* and *RatioDenominator* in GearIn2 are 2 and 1 respectively, the target velocity of the slave axis is twice that of the master axis. When GearIn2_InGear changes to TRUE, the velocity of the slave axis will be twice that of the master axis.

11.4.2 MC_GearOut

FB/FC	Explanation	Applicable model
FB	MC_GearOut is used for ending the established electronic gear relationship between the master axis and slave axis.	DVP15MC11T DVP15MC11T-06

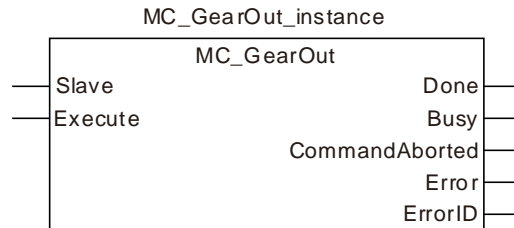

● Input Parameters

Parameter name	Function	Data type	Valid range (Default)	Validation timing
Slave	Specify the number of the slave axis which is to disconnect from the e-gear relationship.	USINT	Refer to Functions of Section 2.2. (The variable value must be set)	When <i>Execute</i> changes from FALSE to TRUE
Execute	The instruction is executed when <i>Execute</i> changes from FALSE to TRUE.	BOOL	TRUE or FALSE (FALSE)	-

Notes:

1. The slave axis will continue to move at the speed of disconnection if the slave axis disconnects from the e-gear relationship through the MC_GearOut instruction after the two axes has built the e-gear relationship through the MC_GearIn instruction.
2. The slave axis can execute other motion instructions after the MC_GearOut instruction execution is completed.
3. The relationship between the master axis and slave axis is disconnected through the MC_GearOut instruction. To stop the motion of the slave axis, MC_Halt or MC_Stop instruction can be used.

● Output Parameters

Parameter name	Function	Data type	Valid range
Done	TRUE when the e-gear relationship between the slave axis and master axis is disconnected and the MC_GearOut instruction is controlling the axes.	BOOL	TRUE / FALSE
Busy	TRUE when the instruction is being executed.	BOOL	TRUE / FALSE
CommandAborted	TRUE when the instruction is aborted.	BOOL	TRUE / FALSE
Error	TRUE when there is an error in the execution of the instruction.	BOOL	TRUE / FALSE
ErrorID	Contains the error code when an error occurs. Please refer to section 12.2.	WORD	

● Output Update Timing

Name	Timing for changing to TRUE	Timing for changing to FALSE
Done	◆ When the electronic gear relationship between the slave axis and master axis is disconnected	◆ When <i>CommandAborted</i> changes to TRUE ◆ When <i>Error</i> changes to TRUE
Busy	◆ When <i>Execute</i> changes to TRUE	◆ When <i>CommandAborted</i> changes to TRUE ◆ When <i>Error</i> changes to TRUE

Name	Timing for changing to TRUE	Timing for changing to FALSE
CommandAborted	◆ When the instruction execution is aborted by other motion instruction	◆ When <i>Execute</i> changes from TRUE to FALSE ◆ <i>CommandAborted</i> is set to TRUE when the instruction is aborted by other instruction after <i>Execute</i> changes from TRUE to FALSE in the course of the instruction execution. One period later, <i>CommandAborted</i> changes to FALSE
Error	◆ When an error occurs in the instruction execution or the input parameters for the instruction are illegal	◆ When <i>Execute</i> changes from TRUE to FALSE.

● Output Update Timing Chart

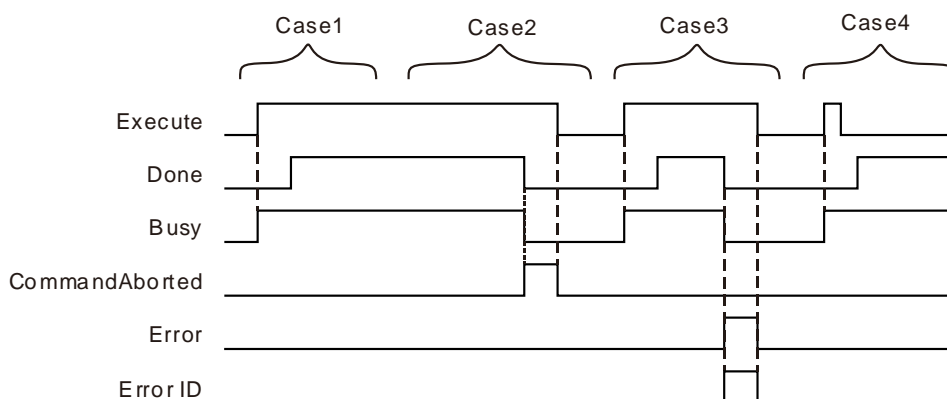

- Case 1 :** *Busy* changes to TRUE as *Execute* changes from FALSE to TRUE. One period later, *Done* changes to TRUE. *Busy* and *Done* remain TRUE after *Execute* changes from TRUE to FALSE.
- Case 2 :** If the MC_GearOut instruction is aborted by other instruction as *Execute* changes to TRUE, *CommandAborted* changes to TRUE and meanwhile *Busy* and *Done* change to FALSE. *CommandAborted* changes to FALSE as *Execute* changes from TRUE to FALSE.
- Case 3 :** When an error occurs (e.g. the axis is disabled), *Error* changes to TRUE and *ErrorID* shows corresponding error codes after *Execute* changes from FALSE to TRUE. Meanwhile, *Busy* and *Done* change to FALSE. As *Execute* changes from TRUE to FALSE, *Error* changes to FALSE.
- Case 4 :** *Execute* changes from TRUE to FALSE before a period is reached during execution of the MC_GearOut instruction. *Done* changes to TRUE and *Busy* remains TRUE as a period is reached.



Programming Example

Below is the example of the execution of the MC_GearOut instruction.

1. The variable table and program

Variable name	Data type	Initial value
Vel	MC_MoveVelocity	
Axis1	USINT	1
Axis2	USINT	2
Vel_Ex	BOOL	FALSE
Vel_Dir	MC_DIRECTION	1
Vel_BM	MC_Buffer_Mode	0
Vel_Invel	BOOL	

Variable name	Data type	Initial value
Vel_Bsy	BOOL	
Vel_Act	BOOL	
Vel_Abt	BOOL	
Vel_Err	BOOL	
Vel_ErrID	WORD	
GearIn	MC_GearIn	
GearIn_Ex	BOOL	FALSE
GearIn_BM	MC_Buffer_Mode	0
GearIn_InGear	BOOL	
GearIn_Bsy	BOOL	
GearIn_Act	BOOL	
GearIn_Abt	BOOL	
GearIn_Err	BOOL	
GearIn_ErrID	WORD	
GearOut	MC_GearOut	
GearOut_Ex	BOOL	FALSE
GearOut_Done	BOOL	
GearOut_Bsy	BOOL	
GearOut_Act	BOOL	
GearOut_Abt	BOOL	
GearOut_Err	BOOL	
GearOut_ErrID	WORD	

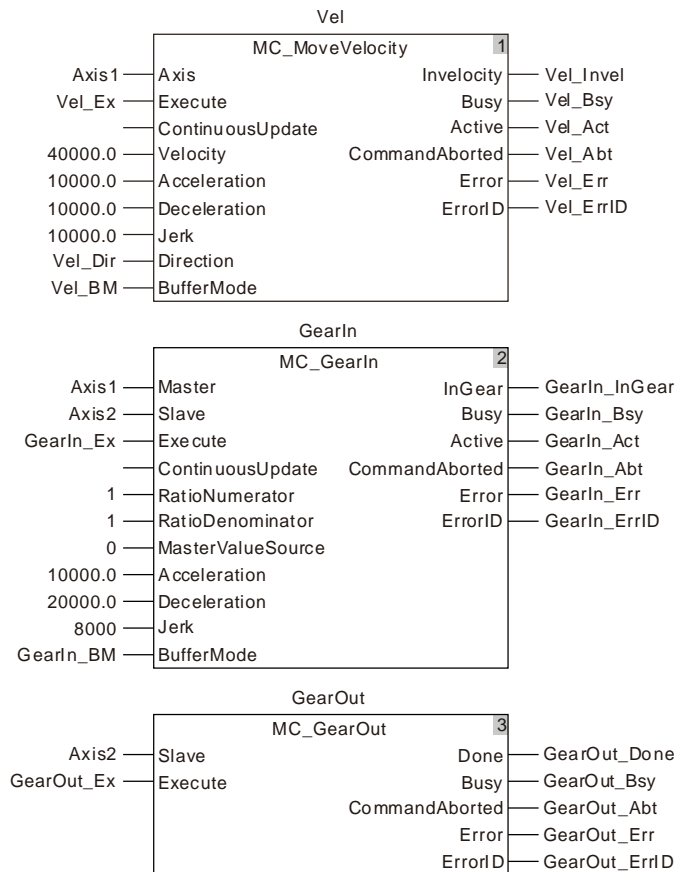

2. Curve and Timing Charts:

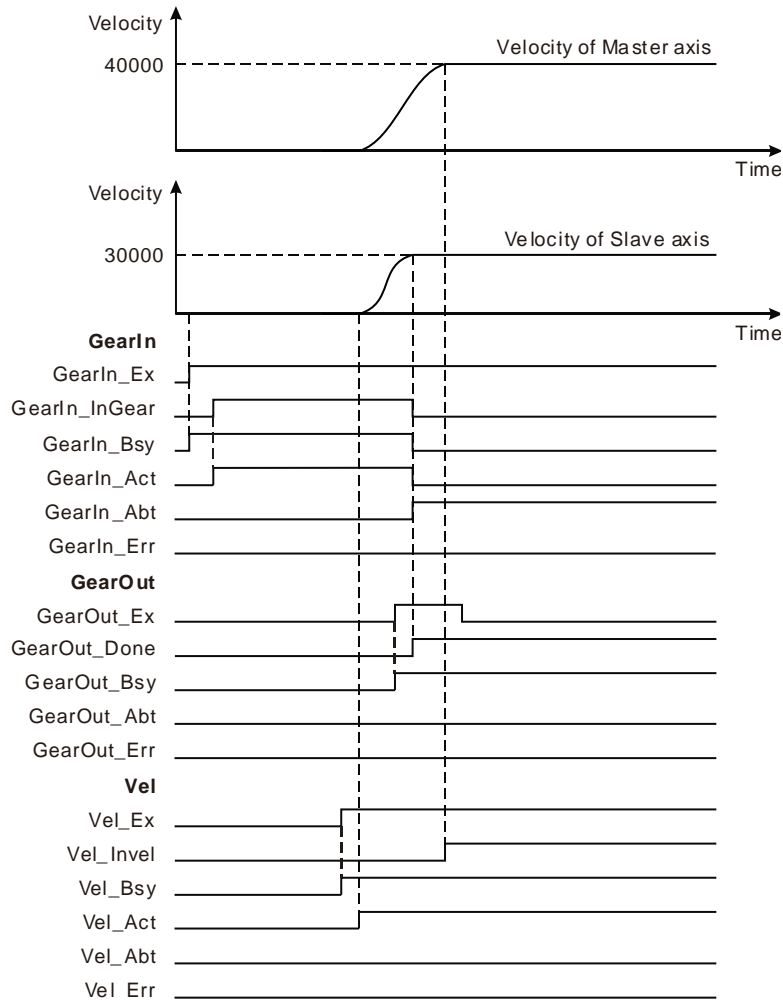

- ❖ As GearIn_Ex changes from FALSE to TRUE, GearIn_Bsy changes to TRUE. And one period later, GearIn_InGear changes to TRUE and the gear relationship between the master axis and slave axis is built.
- ❖ After the gear relationship between the two axes is built, Vel_Ex changes from FALSE to TRUE. One period later, Vel_Act changes to TRUE. The master axis executes the velocity instruction and the slave axis moves by following the motion of the master axis.
- ❖ While the master axis is executing the velocity instruction, GearOut_Ex changes from FALSE to TRUE and GearOut_Bsy changes to TRUE. One period later, GearOut_Done and GearIn_Abt change to TRUE. And the slave axis will continue to move at the current speed.

11.4.3 MC_CombineAxes

FB/FC	Explanation	Applicable model
FB	MC_CombineAxes outputs the sum or difference of the position variations of two master axes as the slave position variation.	DVP15MC11T DVP15MC11T-06

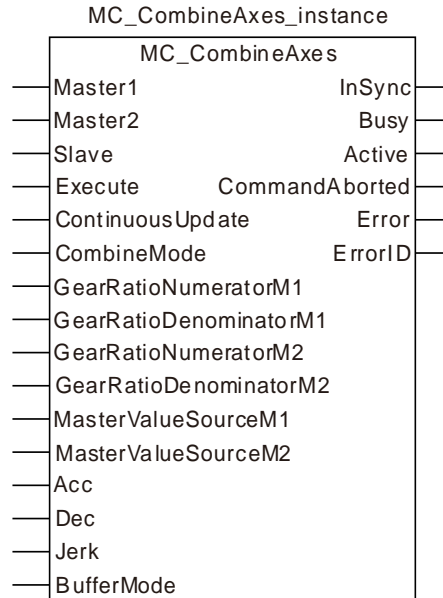

● Input Parameters

Parameter name	Function	Data type	Valid range (Default)	Validation timing
Master1	The position source of axis 1	USINT	Refer to Functions of Section 2.2. (The variable value must be set)	When <i>Execute</i> changes from FALSE to TRUE
Master2	The position source of axis 2	USINT	Refer to Functions of Section 2.2. (The variable value must be set)	When <i>Execute</i> changes from FALSE to TRUE
Slave	The controlled slave	USINT	Refer to Functions of Section 2.2. (The variable value must be set)	When <i>Execute</i> changes from FALSE to TRUE
Execute	The instruction is executed when <i>Execute</i> changes from FALSE to TRUE.	BOOL	TRUE or FALSE (FALSE)	--
ContinuousUpdate	Reserved	-	-	-
CombineMode	Combining method selection. 0: Sum of two master axis position variations 1: Difference of two master axis position variations	MC_CombineMode	0: mcAddAxes 1: mcSubAxes (0)	When <i>Execute</i> changes from FALSE to TRUE
GearRatioNumeratorM1	Specify the master axis1 gear ratio	LREAL	Positive number or negative number	When <i>Execute</i> changes from FALSE

Parameter name	Function	Data type	Valid range (Default)	Validation timing
	numerator.		(The variable value must be set)	to TRUE
GearRatioDenominatorM1	Specify the master axis1 gear ratio denominator.	LREAL	Positive number or negative number (The variable value must be set)	When <i>Execute</i> changes from FALSE to TRUE
GearRatioNumeratorM2	Specify the master axis2 gear ratio numerator.	LREAL	Positive number or negative number (The variable value must be set)	When <i>Execute</i> changes from FALSE to TRUE
GearRatioDenominatorM2	Specify the master axis2 gear ratio denominator.	LREAL	Positive number or negative number (The variable value must be set)	When <i>Execute</i> changes from FALSE to TRUE
MasterValueSourceM1	Specify the synchronization position source of master axis 1. 0 : Command position 1 : Actual position	MC_SOURCE	0:mcSetValue 1:mcActualValue (0)	When <i>Execute</i> changes from FALSE to TRUE
MasterValueSourceM2	Specify the synchronization position source of master axis 2. 0 : Command position 1 : Actual position	MC_SOURCE	0:mcSetValue 1:mcActualValue (0)	When <i>Execute</i> changes from FALSE to TRUE
Acc	Specify the acceleration for the slave axis.	LREAL	Positive number (The variable value must be set)	When <i>Execute</i> changes from FALSE to TRUE
Dec	Specify the deceleration for the slave axis.	LREAL	Positive number (The variable value must be set)	When <i>Execute</i> changes from FALSE to TRUE
Jerk	Specify the change rate of the acceleration for the slave axis.	LREAL	Positive number (The variable value must be set)	When <i>Execute</i> changes from FALSE to TRUE
BufferMode	Specify the behavior when executing two instructions. 0 : Aborted 1 : Buffered	MC_Buffer_Mode	0 : mcAborting 1 : mcBuffered (0)	When <i>Execute</i> changes from FALSE to TRUE

Notes:

1. The instruction execution starts when *Execute* changes from FALSE to TRUE. When *Execute* changes from FALSE to TRUE again no matter whether the instruction execution is completed or not, the instruction cannot be re-executed and the previous setting values will be kept.
2. Refer to section 10.2 for the relation among *Position*, *Velocity*, *Acceleration* and *Jerk*.
3. Refer to section 10.3 for the details about *BufferMode*.

- **Output Parameters**

Parameter name	Function	Data type	Valid range
InSync	TRUE when the slave axis has completed the synchronization action.	BOOL	TRUE / FALSE

Parameter name	Function	Data type	Valid range
Busy	TRUE when the instruction is being executed.	BOOL	TRUE / FALSE
Active	TRUE when the axis is being controlled.	BOOL	TRUE / FALSE
CommandAborted	TRUE when the instruction is aborted.	BOOL	TRUE / FALSE
Error	TRUE when there is an error in the execution of the instruction.	BOOL	TRUE / FALSE
ErrorID	Contains the error code when an error occurs. Please refer to section 12.2.	WORD	

● **Output Update Timing**

Parameter Name	Timing for changing to TRUE	Timing for changing to FALSE
InSync	◆ When the slave axis completes the synchronization action.	◆ When <i>Error</i> changes to TRUE. ◆ When <i>CommandAborted</i> changes to TRUE.
Busy	◆ When <i>Execute</i> is TRUE.	◆ When <i>CommandAborted</i> changes to TRUE. ◆ When <i>Error</i> changes to TRUE.
Active	◆ When the instruction starts to control the axis.	◆ When <i>CommandAborted</i> changes to TRUE. ◆ When <i>Error</i> changes to TRUE.
CommandAborted	◆ When this instruction execution is aborted by other motion control instruction.	◆ When <i>Execute</i> changes from TRUE to FALSE ◆ <i>CommandAborted</i> is set to TRUE when the instruction is aborted after <i>Execute</i> changes from TRUE to FALSE during the instruction execution. One cycle later, <i>CommandAborted</i> changes to FALSE.
Error	◆ When an error occurs in the instruction execution or the input parameters for the instruction are illegal.	◆ When <i>Execute</i> changes from TRUE to FALSE

● **Output Update Timing Chart**

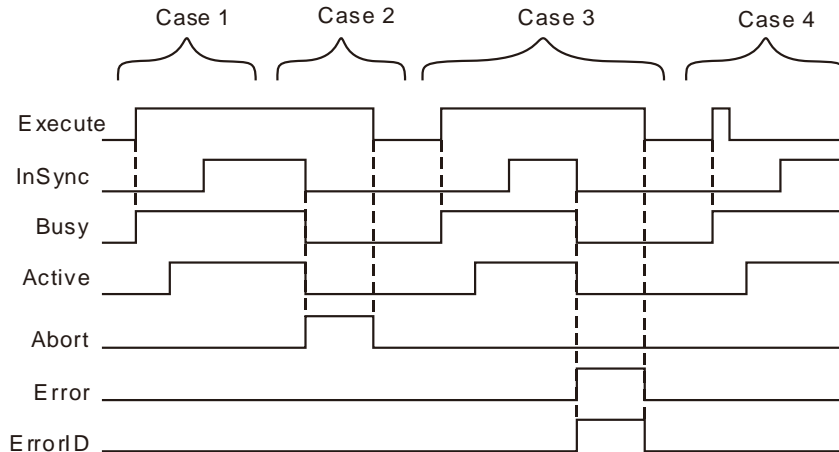

Case 1 : When *Execute* changes from FALSE to TRUE, *Busy* changes to TRUE. One cycle later, *Active* changes to TRUE. When the slave axis has synchronized with the two master axes, *InSync* changes to TRUE and *Busy* and *Active* remain TRUE.

Case 2 : When *Execute* is TRUE, *Busy* is TRUE and *Active* is TRUE. When the slave have synchronized with the two master axes, *InSync* is TRUE. At the moment, the instruction is aborted by another instruction, *CommandAborted* changes to TRUE and meanwhile *Invelocity*, *Busy* and *Active* change to FALSE. When *Execute* changes from TRUE to FALSE, *CommandAborted* changes to FALSE.

Case 3 : When *Execute* changes from FALSE to TRUE, *Error* changes to TRUE and *ErrorID* shows corresponding error codes when an error occurs such as axis alarms or offline. Meanwhile, *InSync*, *Busy* and *Active* change to FALSE. When *Execute* changes from TRUE to FALSE, *Error* changes to FALSE.

Case 4 : The instruction is still executed and the states of *Busy* and *Active* do not change after *Execute* changes from TRUE to FALSE during execution of the instruction. When the slave axis has been synchronized with the two master axes, *InSync* changes to TRUE and *Busy* and *Active* remain TRUE.

● **Function**

MC_CombineAxes outputs the sum or difference of the position variations of two master axes as the slave position variation.

■ **Combine modes: Addition or Subtraction**

The addition or subtraction of the position variations of master axis 1 and master axis 2 are conducted and the calculation result is output as slave axis position variation.

■ **CombineMode is set to 0**

$$\text{Position variation of Slave axis} = \text{Position variation of Master axis1} \times \frac{\text{GearRatioNumeratorM1}}{\text{GearRatioDenominatorM1}} + \text{Position variation of Master axis2} \times \frac{\text{GearRatioNumeratorM2}}{\text{GearRatioDenominatorM2}}$$

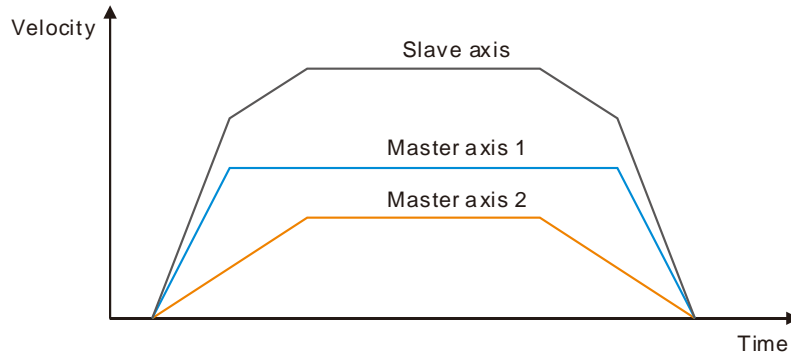

■ **CombineMode is set to 1**

Position variation of Slave axis =

$$= \text{Position variation of Master axis1} \times \frac{\text{GearRatioNumeratorM1}}{\text{GearRatioDenominatorM1}} - \text{Position Variation of Master axis2} \times \frac{\text{GearRatioNumeratorM2}}{\text{GearRatioDenominatorM2}}$$

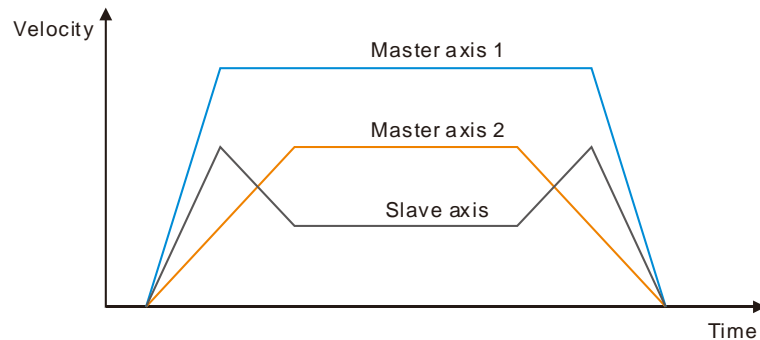

- The master gear ratio numerator and denominator are the factors to adjust the position variations of two master axes. See the formula above.
- *MasterValueSource* can be set to 0 (command position) and 1 (actual position) so as to specify the source of the position variation. If the value is set to 0, add up the master axis command position variations. If the value is set to 1, subtract one master axis actual position variation from another master axis actual position variation.
- The *Acc*, *Dec* and *Jerk* indicate that the master axis has been in motion before the instruction is executed. If the instruction is executed at the moment, the slave axis will speed up or down according to the set acceleration, deceleration and jerk so as to realize the synchronization with the master position variations. When the synchronization is achieved, *InSync* is TRUE and the instruction execution is completed.
- Use other motion instruction (such as MC_Stop instruction) for the control over the slave axis so as to end the master-slave axis relationship in the instruction. Set the value of *BufferMode* of other motion instruction which has the *Buffermode* parameter to 0 in order to abort the MC_CombineAxes instruction and disconnect the master-slave axis relationship.
- If the master axis gear ratio is to be switched during the motion, use another MC_CombineAxes instruction to abort the MC_CombineAxes instruction which is being executed.



Programming Example

The example of executing the MC_CombineAxes instruction is described as below.

1. The variable table and program

Variable name	Data type	Initial value
Pwr1	MC_Power	
Axis1	USINT	1
Pwr1_BM	MC_Buffer_Mode	1
Pwr1_Sta	BOOL	

Variable name	Data type	Initial value
Pwr1_Bsy	BOOL	
Pwr1_Act	BOOL	
Pwr1_Err	BOOL	
Pwr1_ErrID	WORD	
Pwr2	MC_Power	
Axis2	USINT	1
Pwr2_BM	MC_Buffer_Mode	1
Pwr2_Sta	BOOL	
Pwr2_Bsy	BOOL	
Pwr2_Act	BOOL	
Pwr2_Err	BOOL	
Pwr2_ErrID	WORD	
Pwr3	MC_Power	
Axis3	USINT	1
Pwr3_BM	MC_Buffer_Mode	1
Pwr3_Sta	BOOL	
Pwr3_Bsy	BOOL	
Pwr3_Act	BOOL	
Pwr3_Err	BOOL	
Pwr3_ErrID	WORD	
CombinA	MC_CombineAxes	
CombinA_Ex	BOOL	FALSE
CombinA_BM	MC_Buffer_Mode	1
CombinA_InSync	BOOL	
CombinA_Bsy	BOOL	
CombinA_Act	BOOL	
CombinA_Abt	BOOL	
CombinA_Err	BOOL	
CombinA_ErrID	WORD	
Rel1	MC_MoveRelative	
Rel1_Ex	BOOL	FALSE
Rel1_Dir	MC_DIRECTION	1
Rel1_BM	MC_Buffer_Mode	0
Rel1_Done	BOOL	
Rel1_Bsy	BOOL	
Rel1_Act	BOOL	
Rel1_Abt	BOOL	
Rel1_Err	BOOL	
Rel1_ErrID	WORD	
Rel2	MC_MoveRelative	
Rel2_Ex	BOOL	FALSE
Rel2_Dir	MC_DIRECTION	1
Rel2_BM	MC_Buffer_Mode	0
Rel2_Done	BOOL	
Rel2_Bsy	BOOL	

Variable name	Data type	Initial value
Rel2_Act	BOOL	
Rel2_Abt	BOOL	
Rel2_Err	BOOL	
Rel2_ErrID	WORD	

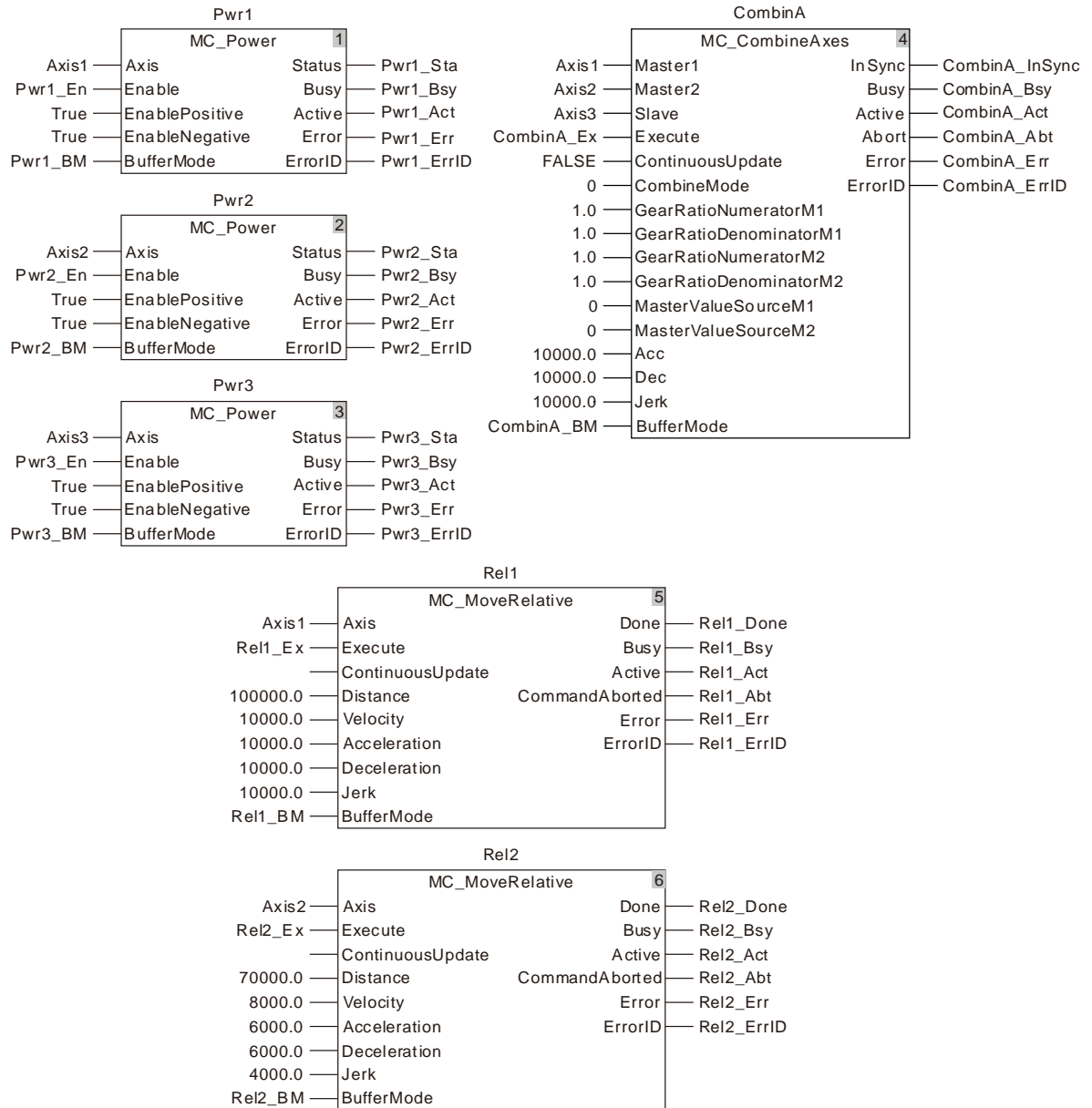

2. Motion Curve and Timing Chart

11

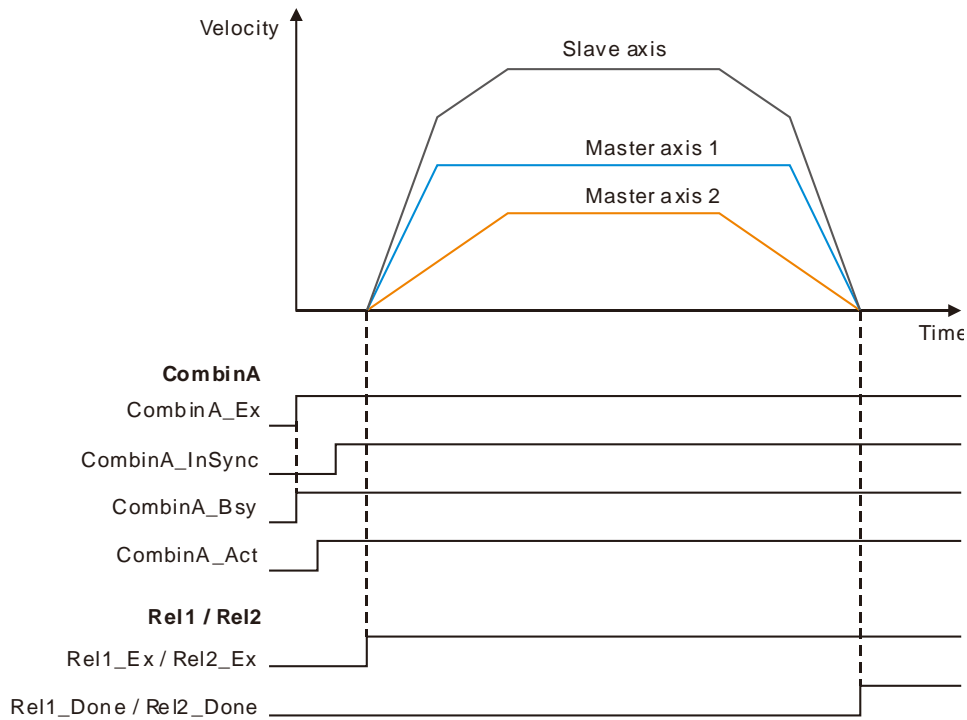

- ❖ When CombiA_Ex change from FALSE to TRUE, the execution of the MC_CombineAxes instruction starts. After a period of time, the instruction execution succeeds, CombiA_InSync changes to TRUE and three axes can go into the synchronized motion as required. At the moment, Executes of MC_MoveRelatives for the two master axes are set to TRUE and then the two master axes start to run and meanwhile the slave also starts to run according to the sum of two master axis position variations. The slave axis position variation is the sum of the two master axis position variations in the unit time. After the instructions executed for the master axes are completed, the three axes remain in the synchronized state. To abort the synchronization state of the three axes, use MC_Stop instruction to abort the slave axis motion and disconnect the synchronization state.

11.4.4 Introduction of Electronic Cam

The cam is the component with the curve profile or grooves. It transmits the motion to the follower near its edge and the rack will turn periodically following the follower. The cam mechanism consists of a cam, follower and rack. The following figure shows the cam profile made up of point A, B, C, and D. AB' is a follower which is connected to the rack. δ_4 is an inner angle of repose; δ_2 is an external angle of repose. The radius of the base circle is r_0 and S is the cam curve.

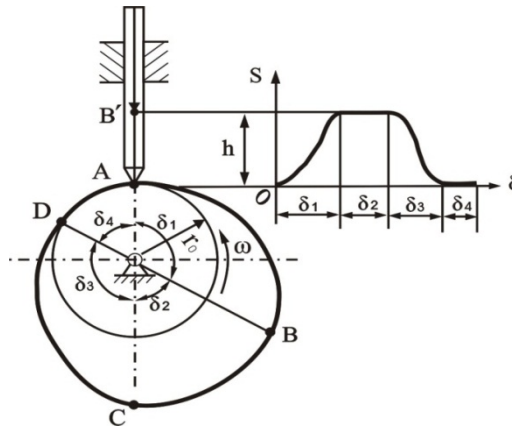

Figure 11.4.4.1

The electronic cam is an analog cam of the mechanical cam through applying computer technology. Compared with the mechanical cam, the electronic cam has many advantages of being easy to design and modify; cost saving; higher efficiency and preciseness. Because the electronic cam is an analog cam, the defects of a mechanical cam like being easy to be damaged and not fit for high-speed rotation and transmission can be avoided for the electronic cam.

the motion controller supports the function of the electronic cam. User can edit the cam curve in the corresponding cam editor software.

The cam curve need be called in the motion control program after being edited. The motion control program can call the cam curve by using the MC_CamIn instruction.

11.4.5 MC_CamIn

FB/FC	Explanation	Applicable model
FB	MC_CamIn is used to build the cam relationship between two axes according to the set parameters.	DVP15MC11T DVP15MC11T-06

11

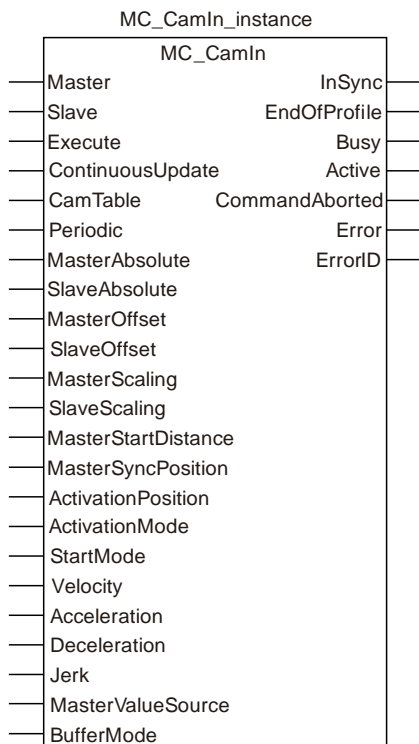

● Input Parameters

Parameter name	Function	Data type	Valid range (Default)	Validation timing
Master	Specify the number of the master axis in the electronic cam operation.	USINT	Refer to Functions of Section 2.2. (The variable value must be set)	When <i>Execute</i> changes from FALSE to TRUE
Slave	Specify the number of the slave axis in the electronic cam operation.	USINT	Refer to Functions of Section 2.2. (The variable value must be set)	When <i>Execute</i> changes from FALSE to TRUE
Execute	The instruction is executed when <i>Execute</i> changes from FALSE to TRUE.	BOOL	TRUE or FALSE (FALSE)	-
ContinuousUpdate	Reserved			
CamTable	Specify the cam table used for building a cam relationship between the master axis and slave axis	USINT	1~64 (The variable value must be set)	When <i>Execute</i> changes from FALSE to TRUE
Periodic	Specify whether to execute the specified cam table periodically or just one period.	BOOL	TRUE or FALSE (FALSE)	When <i>Execute</i> changes from FALSE to TRUE
MasterAbsolute	Specify the position mode of the master axis. TRUE: Absolute position FALSE: Relative position	BOOL	TRUE or FALSE (FALSE)	When <i>Execute</i> changes from FALSE to TRUE

Parameter name	Function	Data type	Valid range (Default)	Validation timing
SlaveAbsolute	Specify the position mode of the slave axis. TRUE: Absolute position FALSE: Relative position	BOOL	TRUE or FALSE (FALSE)	When <i>Execute</i> changes from FALSE to TRUE
MasterOffset	Specify how many units the master axis position shifts by. (Unit: Unit)	LREAL	Negative number, positive number and 0 (0)	When <i>Execute</i> changes from FALSE to TRUE
SlaveOffset	Specify how many units the slave axis position shifts by. (Unit: Unit)	LREAL	Negative number, positive number and 0 (0)	When <i>Execute</i> changes from FALSE to TRUE
MasterScaling	Specify the scaling of the master axis position.	LREAL	Positive number (The variable value must be set)	When <i>Execute</i> changes from FALSE to TRUE
SlaveScaling	Specify the scaling of the slave axis position.	LREAL	Positive number or negative number (The variable value must be set)	When <i>Execute</i> changes from FALSE to TRUE
MasterStartDistance	Reserved			
MasterSyncPosition	Reserved			
ActivationPosition	Specify the position of the master axis as the engagement begins. In other words, when the master axis passes the position, the slave axis starts to perform the engagement action.	LREAL	Negative number, positive number and 0 (0)	When <i>Execute</i> changes from FALSE to TRUE
ActivationMode	Specify the mode of the position where to start the engagement	MC_ACTIVATION_MODE	0: mcRelative (Relative axis position) 1: mcAbsolute (Absolute axis position) 2: mcPhase_Axis (Absolute axis phase) 3: mcPhase_CAM (Absolute cam phase) (0)	When <i>Execute</i> changes from FALSE to TRUE
StartMode	Specify the way how the slave axis performs the engagement action.	MC_START_MODE	0: mcRampInShortest (The shortest way) 1: mcRampInPositive (Positive direction) -1: mcRampInNegative (Negative direction) (0)	When <i>Execute</i> changes from FALSE to TRUE
Velocity	Specify the maximum stacking velocity of the slave axis during the period when the slave axis performs the engagement action. (Unit: Unit/second)	LREAL	Positive number (The variable value must be set)	When <i>Execute</i> changes from FALSE to TRUE
Acceleration	Specify the maximum acceleration of the slave axis during the period when the slave axis performs the engagement action. (Unit: Unit/second ²)	LREAL	Positive number (The variable value must be set)	When <i>Execute</i> changes from FALSE to TRUE

Parameter name	Function	Data type	Valid range (Default)	Validation timing
Deceleration	Specify the maximum deceleration of the slave axis during the period when the slave axis performs the engagement action. (Unit: Unit/second ² .)	LREAL	Positive number (The variable value must be set)	When <i>Execute</i> changes from FALSE to TRUE
Jerk	Reserved	-	-	-
MasterValueSource	Specify the type of the master axis position in the electronic cam calculation.	MC_SOURCE	0:mcSetValue 1:mcActualValue (0)	When <i>Execute</i> changes from FALSE to TRUE
BufferMode	Specify the behavior when executing two instructions.	MC_Buffer_Mode	0: mcAborting 1: mcBuffered (0)	When <i>Execute</i> changes from FALSE to TRUE

Note:

1. The MC_CamIn instruction execution starts when *Execute* changes from FALSE to TRUE. Changing *Execute* from TRUE to FALSE does not influence the instruction execution during execution of the instruction.
2. Changing *Execute* from FALSE to TRUE again does not influence the instruction execution during execution of the instruction. The instruction will keep going in the previous way.
3. Refer to Section 10.3 for details on *BufferMode*.

- **Output Parameters**

Parameter name	Function	Data type	Valid range
InSync	TRUE when the master axis and slave axis move synchronously based on the cam curve.	BOOL	TRUE / FALSE
EndOfProfile	TRUE when the cam motion reaches the end point.	BOOL	TRUE / FALSE
Busy	TRUE when the instruction is being executed.	BOOL	TRUE / FALSE
Active	TRUE when the axis is being controlled.	BOOL	TRUE / FALSE
CommandAborted	TRUE when the instruction is aborted.	BOOL	TRUE / FALSE
Error	TRUE when there is an error in the execution of the instruction.	BOOL	TRUE / FALSE
ErrorID	Contains the error code when an error occurs. Please refer to the section 12.2.	WORD	

- **Output Update Timing**

Name	Timing for changing to TRUE	Timing for changing to FALSE
InSync	<ul style="list-style-type: none"> ◆ When the slave axis and master axis are synchronous in the cam motion. 	<ul style="list-style-type: none"> ◆ When the cam relationship between the slave axis and master axis is disconnected. ◆ When the acyclic cam motion is performed (<i>Periodic</i>=FALSE) and <i>EndOfProfile</i> changes to TRUE ◆ When <i>CommandAborted</i> changes to TRUE ◆ When <i>Error</i> changes to TRUE
EndOfProfile	<ul style="list-style-type: none"> ◆ When the cam motion reaches the end point in the cam table. 	<ul style="list-style-type: none"> ◆ One period after <i>EndOfProfile</i> changes to TRUE

Name	Timing for changing to TRUE	Timing for changing to FALSE
Busy	<ul style="list-style-type: none"> ◆ When <i>Execute</i> changes to TRUE 	<ul style="list-style-type: none"> ◆ When the acyclic cam motion is performed (<i>Periodic</i>=FALSE) and <i>EndOfProfile</i> changes to TRUE ◆ When <i>Error</i> changes to TRUE ◆ When <i>CommandAborted</i> changes to TRUE
Active	<ul style="list-style-type: none"> ◆ When the instruction starts to control axes 	<ul style="list-style-type: none"> ◆ When the acyclic cam motion is performed (<i>Periodic</i>=FALSE) and <i>EndOfProfile</i> changes to TRUE ◆ When <i>Error</i> changes to TRUE ◆ When <i>CommandAborted</i> changes to TRUE
CommandAborted	<ul style="list-style-type: none"> ◆ When the instruction execution is aborted by other motion instruction 	<ul style="list-style-type: none"> ◆ When <i>Execute</i> changes from TRUE to FALSE ◆ <i>CommandAborted</i> is set to TRUE when the instruction is aborted by other instruction after <i>Execute</i> changes from TRUE to FALSE in the course of the instruction execution. One period later, <i>CommandAborted</i> changes to FALSE.
Error	<ul style="list-style-type: none"> ◆ When an error occurs in the instruction execution or the input parameters for the instruction are illegal 	<ul style="list-style-type: none"> ◆ When <i>Execute</i> changes from TRUE to FALSE

● **Output Update Timing Chart**

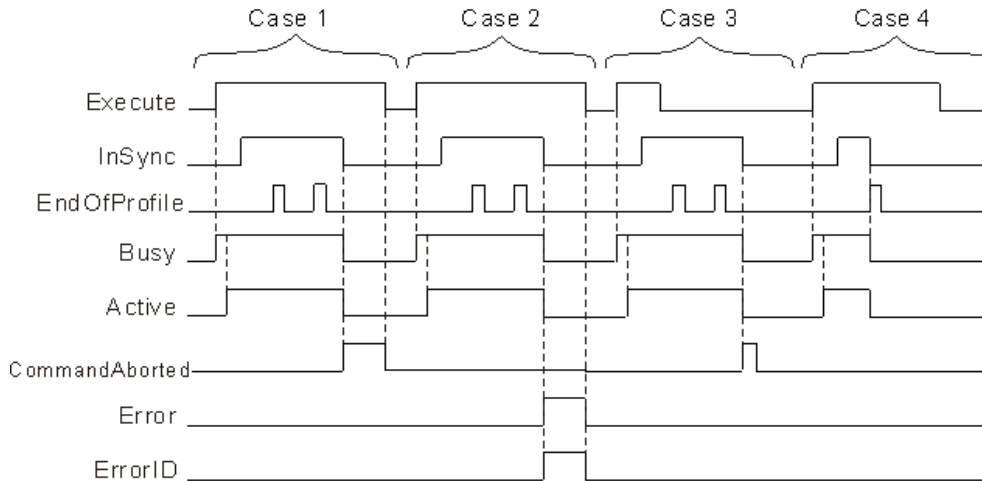

- Case 1 :** *Busy* changes to TRUE as *Execute* changes from FALSE to TRUE. And one period later, *Active* changes to TRUE. When the slave axis and master axis are in the synchronous motion, *InSync* changes from FALSE to TRUE. When the final point of the cam cycle is reached, *EndOfProfile* changes from FALSE to TRUE and changes to FALSE one cycle later. When the cam relationship between the slave axis and master axis is disconnected (e.g. by executing the MC_CamOut instruction), *CommandAborted* changes from FALSE to TRUE and *InSync*, *Busy* and *Active* all change from TRUE to FALSE. After that, *CommandAborted* changes from TRUE to FALSE as *Execute* changes from TRUE to FALSE.
- Case 2 :** As an error occurs in the execution of the instruction, *Error* changes from FALSE to TRUE, *ErrorID* shows corresponding error codes and *InSync*, *Busy* and *Active* all change from TRUE to FALSE. After that, *Error* changes from TRUE to FALSE and the value of *ErrorID* changes to 0 as *Execute* changes from TRUE to FALSE.
- Case 3 :** The instruction execution still continues after *Execute* changes from TRUE to FALSE during execution of the instruction. The timing for changing the state of *InSync*, *EndOfProfile*, *Busy* and *Active* is consistent with what state they are in as *Execute* is TRUE. After that, *InSync*, *Busy* and *Active* all change from TRUE to FALSE after the cam relationship between the slave axis and master axis is disconnected. Meanwhile *CommandAborted* changes from FALSE to TRUE and changes to FALSE one cycle later.
- Case 4 :** If the cam motion is performed in the acyclic way (*Periodic*=FALSE), *EndOfProfile* changes from FALSE to TRUE when the end point of the cam cycle is reached. Meanwhile *InSync*, *Busy* and *Active* all change from TRUE to FALSE and *EndOfProfile* changes from TRUE to FALSE one cycle later.

● **Function**

The *MC_CamIn* instruction is used for making the slave axis and master axis move synchronously according to the planned cam relationship. The *MC_CamOut* instruction is used for disconnecting the cam relationship between the two axes.

■ About MC_CamIn Instruction

➤ MC_CamIn Execution Process

The MC_CamIn execution process figure:

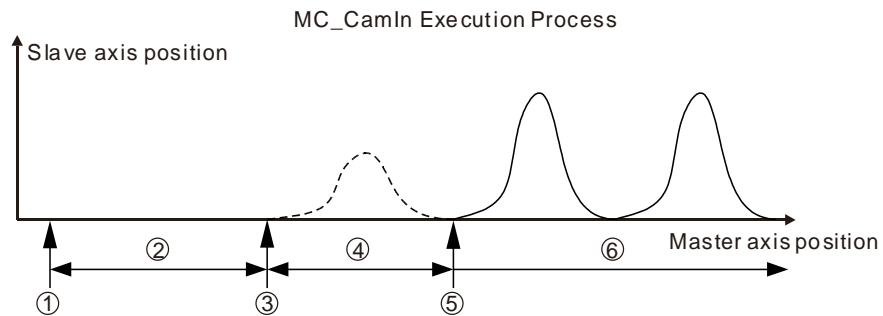

Stage 1: Trigger and execute the MC_CamIn instruction.

Stage 2: Wait for the start of the engagement.

Stage 3: The slave axis starts to perform the engagement action as the master axis reaches the position where the engagement starts.

Stage 4: The engagement is ongoing.

Stage 5: The master axis and slave axis achieve the synchronization as the engagement is completed.

Stage 6: The master axis and slave axis are in the synchronous motion.

Stage 1: Trigger and execute the MC_CamIn instruction.

The MC_CamIn instruction is executed at this time and then the slave will enter the state of waiting for the start of the engagement immediately.

NOTE: If *ActivationPosition*=0 and *ActivationMode*=0 (relative axis position), the slave axis will move from current speed to SYNC speed. Except in the case above, the slave axis will stop moving immediately! All set input parameters of the MC_CamIn instruction will be read and retained for use in the execution.

Stage 2: Wait for the start of the engagement.

The slave axis waits for the timing for performing the engagement action in the standstill state. The time to start the engagement is when the master axis passes the position specified by the parameter *ActivationPosition*. In different circumstances, the period of time the slave axis waits for is different. If the master axis is at the position specified by *ActivationPosition* as the MC_CamIn instruction is executed, the slave axis starts the engagement action immediately. If the master axis never reaches the position specified by *ActivationPosition*, the slave axis will never start to perform the engagement action and the cam synchronization will never come true. The parameters *ActivationPosition* and *ActivationMode* are used at this stage.

Stage 3: The slave axis starts to perform the engagement action when the master axis passes the position specified by *ActivationPosition*. The parameters, *MasterAbsolute*, *SlaveAbsolute*, *MasterOffset*, *SlaveOffset*, *MasterScaling* and *SlaveScaling* will work at the moment for making sure of the corresponding relationship between the master axis position and slave axis position and the cam phase.

Stage 4: The engagement is ongoing.

The slave axis performs the engagement in the way specified by the *StartMode* parameter. Besides *StartMode*, the parameters *Velocity*, *Acceleration* and *Deceleration* also works at this stage. The motion features about velocity, acceleration/ deceleration of the slave axis are determined by these parameters in the engagement.

Stage 5: The engagement is completed and the master axis and slave axis achieve the synchronization.

The engagement is completed and the slave axis and master axis achieve the cam synchronization if the cam phase that the master axis and slave axis correspond to meets the planned cam relationship after the slave axis starts to perform the engagement action.

NOTE: In the figure above, the set master axis position at the time when the engagement begins is greater than the master position at the time when the *MC_CamIn* instruction execution starts. The similar way is also applied to the circumstance that the set master axis position at the time when the engagement begins is less than or equal to the master position at the time when the *MC_CamIn* instruction execution starts.

■ **ActivationPosition**

The *ActivationPosition* parameter is the start position of the cam engagement, (which is the master axis position). In other words, the slave axis starts to perform the engagement when the master axis reaches the position specified by *ActivationPosition* after the *MC_CamIn* instruction is triggered and executed.

ActivationPosition can be the master axis position, master axis phase, master axis cam phase, which can be selected through the *ActivationMode* parameter.

➤ **ActivationPosition: Relative axis position**

As *ActivationMode*=0, *ActivationPosition* is an axis position which is relative to the master axis position at the time when the *MC_CamIn* instruction is executed. The master axis position as the actual engagement starts is the value of *ActivationPosition* plus the master position of when the *MC_CamIn* instruction execution begins.

For example: The master axis position is 100 and *ActivationPosition* 1000 at the time when the *MC_CamIn* instruction execution starts. The master axis position is 1100 (1100=100+1000) as the actual engagement begins.

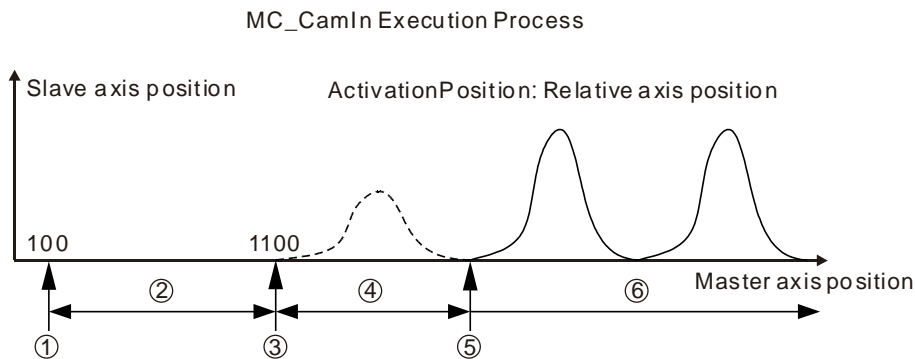

Stage 1: Trigger and execute the *MC_CamIn* instruction. The master axis absolute position is 100 at the moment.

Stage 2: Wait for the start of the engagement.

Stage 3: The master axis reaches the position for starting the engagement (1100) and the slave axis starts to perform the engagement action.

Stage 4: The engagement is ongoing.

Stage 5: The engagement is completed and the master axis and slave axis achieve the synchronization.

Stage 6: The master axis and slave axis are in the synchronous motion.

➤ **ActivationPosition: Absolute axis position**

When *ActivationMode* =1, *ActivationPosition* is an axis position which is absolute to the master axis position at the time when the *MC_CamIn* instruction is executed. The master axis position as the actual engagement starts is *ActivationPosition*.

For example: The master axis position is 100 and *ActivationPosition* 1000 at the time when the *MC_CamIn* instruction execution starts. The master axis position is 1000 (1000=*ActivationPosition*) as the actual engagement begins.

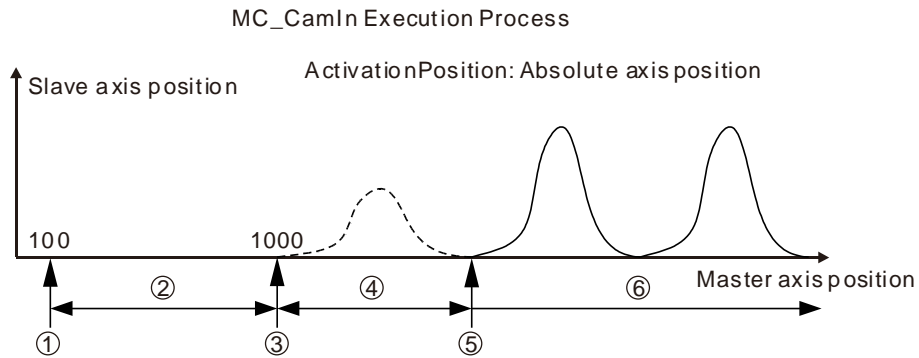

Stage 1: Trigger and execute the MC_CamIn instruction. The master axis absolute position is 100 at the moment.

Stage 2: Wait for the start of the engagement.

Stage 3: The master axis reaches the position for starting the engagement (1000) and the slave axis starts to perform the engagement action.

Stage 4: The engagement is being conducted.

Stage 5: The engagement is completed and the master axis and slave axis achieve the synchronization.

Stage 6: The master axis and slave axis are in the synchronous motion.

➤ **ActivationPosition: Absolute axis phase**

When *ActivationMode* = 2, *ActivationPosition* is an absolute axis phase which is the remainder got by dividing the axis absolute position by modulo. The slave axis starts to perform the engagement action as the master axis absolute phase is *ActivationPosition*.

The absolute axis phase is cyclic. Its absolute axis phase may be equal to *ActivationPosition* many times in the motion of the master axis. But the slave axis starts to perform the engagement action only when the absolute axis phase of the master axis is equal to *ActivationPosition* for the first time after the MC_CamIn instruction is executed.

For example, the master axis modulo is 400, *ActivationPosition*=100 and the master axis position is 1000 at the time when the MC_CamIn instruction is executed. The slave axis will not perform the engagement action because the absolute axis phase of the master axis is 200 ($200=1000\%400$) at the time when the MC_CamIn instruction is executed. The slave axis starts to perform the engagement action as the master axis position is 1300 (Absolute axis phase is $100=1300\%400$) or 900 (Absolute axis phase is $100=900\%400$). (% means the mathematic operation to find the remainder)

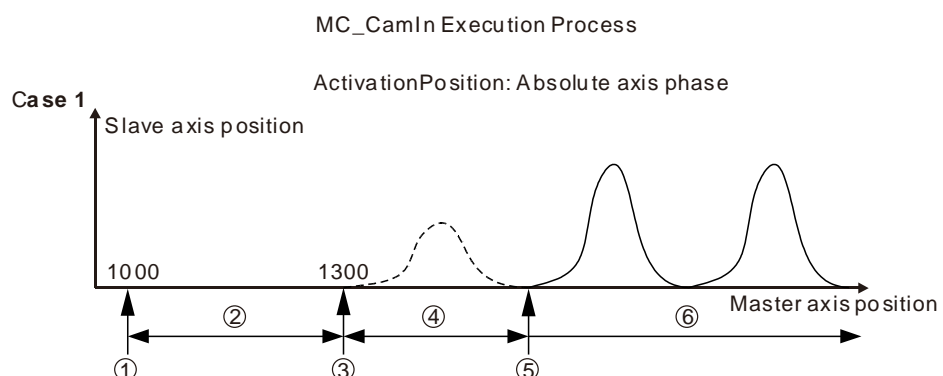

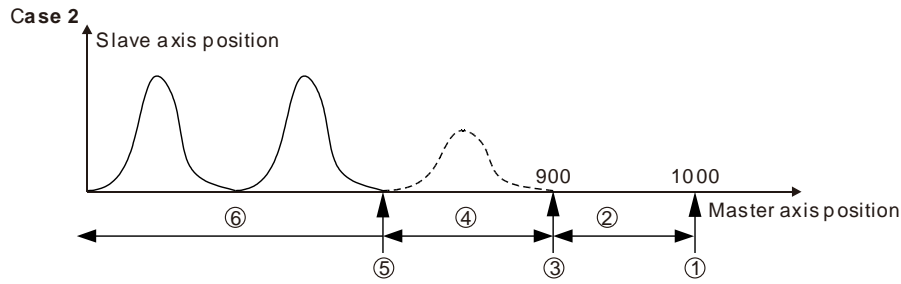

Stage 1: Trigger and execute the MC_CamIn instruction. The master axis absolute position is 1000 at the moment. (The absolute axis phase is 200)

Stage 2: Wait for the start of the engagement.

Stage 3: The master axis reaches the position for starting the engagement (1300 in circumstance 1 and 900 in circumstance 2) and the slave axis starts to perform the engagement action.

Stage 4: The engagement is being conducted.

Stage 5: The engagement is completed and the master axis and slave axis achieve the synchronization.

Stage 6: The master axis and slave axis are in the synchronous motion.

NOTE: As *ActivationPosition* is the absolute axis phase, the range of the *ActivationPosition* parameter value is 0~modulo (excluding modulo). If the value of *ActivationPosition* exceeds the valid range, an error will occur and the instruction execution will fail as the *MC_CamIn* instruction is executed.

➤ ***ActivationPosition*: Absolute cam phase**

When *ActivationMode* =3, *ActivationPosition* is the absolute cam phase which is the remainder got by dividing the axis absolute position by its cam cycle. The slave axis starts to perform the engagement action as the cam phase of the master axis is *ActivationPosition*.

The cam phase is cyclic. Its cam phase may be equal to *ActivationPosition* many times in the motion of the master axis. But the slave axis starts to perform the engagement action only when the cam phase of the master axis is equal to *ActivationPosition* for the first time after the MC_CamIn instruction is executed.

For example, the maximum position of the master axis in the cam table is 360, *ActivationPosition*=100 and the master axis position is 1000 at the time when the MC_CamIn instruction is executed. The slave axis will not perform the engagement action because the absolute cam phase of the master axis is 280 ($280=1000\%360$) at the time when the MC_CamIn instruction execution begins. Then the slave axis starts to perform the engagement action as the master axis position is 1180 (Absolute cam phase is $100=1180\%360$) or 820 (Absolute cam phase is $100=820\%360$).

MC_CamIn Execution Process

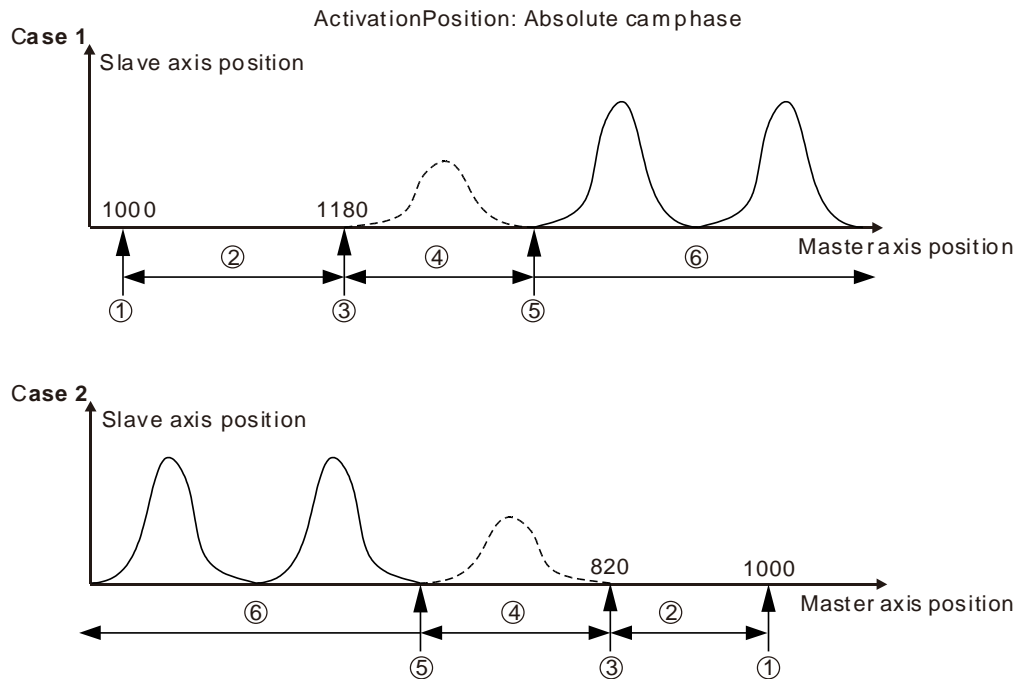

Stage 1: Trigger and execute the MC_CamIn instruction. The master axis absolute position is 1000 at the moment. (The absolute cam phase is 280)

Stage 2: Wait for the start of the engagement.

Stage 3: The master axis reaches the position for starting the engagement (The master axis position is 1180 in circumstance 1 and 820 in circumstance 2) and the slave axis starts to perform the engagement action.

Stage 4: The engagement is being conducted.

Stage 5: The engagement is completed and the master axis and slave axis achieve the synchronization.

Stage 6: The master axis and slave axis are in the synchronous motion.

Note: As *ActivationPosition* is the absolute cam phase, the range of the *ActivationPosition* parameter value is 0~ cam cycle value (excluding the cam cycle value). If the value of *ActivationPosition* exceeds the valid range, an error will occur and the execution will fail as the MC_CamIn instruction is executed.

■ Relationship between the master axis position and slave axis position

The cam relationship which is planned in the software is the position relationship between the master axis and slave axis. The “position” mentioned here is the cam phase of the master axis / slave axis instead of the actual axis position. If the cam relationship which is planned is seen as the function CAM as below, the input of the function CAM is the master axis cam phase and the output is the slave axis cam phase. The formula is shown as below.

$$y = \text{CAM} (x)$$

x : The master axis cam phase

y : The slave axis cam phase

The cam phase comes from the axis positions and there is a conversion between them. The conversion between the axis position and cam phase is related with the *MasterAbsolute*, *SlaveAbsolute*, *MasterOffset*, *SlaveOffset*, *MasterScaling* and *SlaveScaling* parameters.

For details, refer to relevant sections.

The slave axis follows the master axis to make the synchronous cam motion by using the

MC_CamIn instruction. In the synchronous cam motion, the corresponding relationship between the master axis position and slave axis position is based on the pre-planned cam relationship (the cam curve or cam table). The process in which the slave axis position is calculated through the master axis position is illustrated as follows.

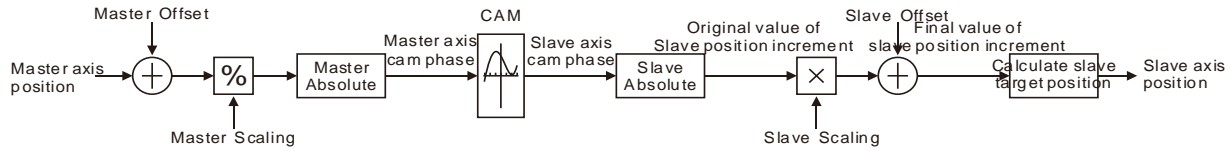

■ **MasterAbsolute and SlaveAbsolute**

The *MasterAbsolute* parameter is used for specifying the corresponding relationship between the master axis position and the cam phase. As *MasterAbsolute* is TRUE, the master axis position and the cam phase are in an absolute relationship. As *MasterAbsolute* is FALSE, the master axis position and the cam phase are in a relative relationship. For *SlaveAbsolute*, the explanation is similar to that of *MasterAbsolute*.

MasterAbsolute and *SlaveAbsolute* work at the moment when the engagement starts. That is to say that the corresponding relationship between the axis position and cam phase is built at the beginning of the engagement. (NOTE: The corresponding relationship is not built at the time when the MC_CamIn instruction execution begins but when the engagement begins.) After that, the cam phase is calculated according to the corresponding relationship.

➤ **Relative mode**

The master axis position and its cam phase are in the relative relationship as the *MasterAbsolute* parameter is FALSE. That is to say, the master axis position corresponds to its cam phase 0 at the time when the engagement starts. After that, the master cam phase will be calculated according to the corresponding relationship. For example, the master axis is in relative mode, the maximum value of the master axis cam phase in the cam relationship is 360 and the master axis position is 180 at the time when the engagement starts. So the master axis position 180 corresponds its cam phase 0; the master axis position 200 corresponds to its cam phase 20 ($20 = (200 - 180) \% 360$) and so on.

In this circumstance, the master axis position corresponds to its cam phase as shown in the following figure.

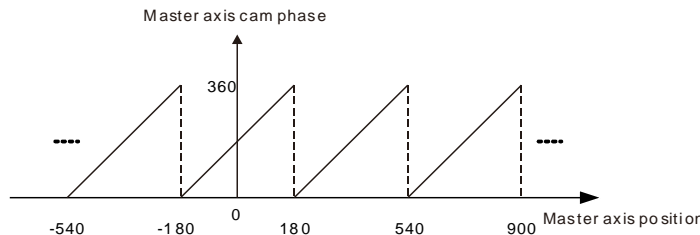

As the *SlaveAbsolute* parameter is FALSE, the slave axis position and its cam phase are in the relative relationship. That is to say, the slave axis cam phase and the master axis cam phase meet the planned cam relationship at the time when the engagement starts. If the slave axis is in relative mode, the method of being sure of the slave axis cam phase is different from the master axis. When the slave axis cam phase is sure, it should meet the condition that the slave axis cam phase and the master axis cam phase meet the planned cam relationship at the time when the engagement starts.

For example, the slave axis is in relative mode, the maximum value of the slave axis cam phase in the cam relationship is 360 and the slave axis position is 100 at the time when the engagement starts. If the master axis cam phase is 0 at the moment (and the slave axis cam phase is 0 as required in the cam relationship), the slave axis position 100 will correspond to its cam phase 0 as shown in the following circumstance 1. If the slave axis cam phase is 200 as required in the cam relationship, the slave axis position 100 will correspond to its cam phase 200 as shown in the following circumstance 2.

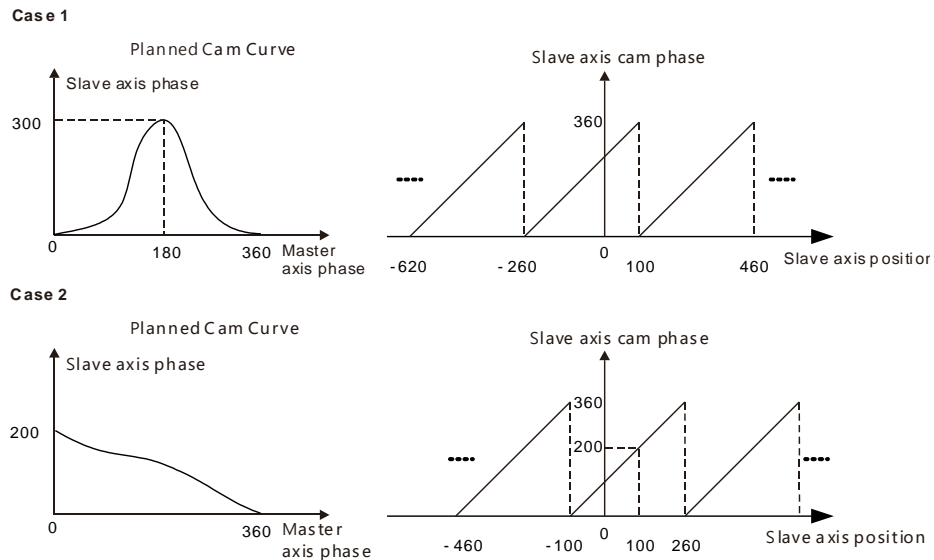

➤ Absolute mode

When the *MasterAbsolute* parameter is TRUE, the master axis position and its cam phase are in the absolute relationship. At any time, the master axis cam phase is equal to the remainder got by dividing the master axis position at that time by the maximum value of the master axis cam phase in the cam relationship.

For example, the master axis is in absolute mode and the maximum value of the master axis in the cam relationship is 360. So its cam phase is 100 as the master axis position is 100 ($100 = 100 \% 360$); its cam phase is 140 ($140 = 500 \% 360$) as the master axis position is 500 and so on. The master axis position corresponds to its cam phase as shown in the figure below.

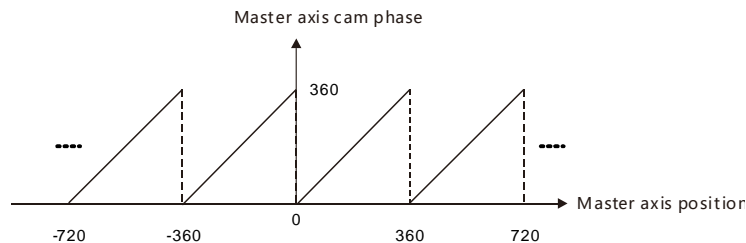

When the *SlaveAbsolute* parameter is TRUE, the slave axis position and its cam phase are in the absolute relationship. At any time, the slave axis cam phase is equal to the remainder got by dividing the slave axis position at that time by the maximum value of the slave axis cam phase in the cam relationship. When the slave axis is in absolute mode, the corresponding relationship between the slave axis position and its cam phase is consistent with that between the master axis position and its cam phase when the master axis is in absolute mode.

■ Offset and Scaling

The cam relationship between the master axis and slave axis is preplanned. But as the cam motion is executed, the position offset or scaling based on the preplanned cam relationship can be performed through setting the *Offset* and *Scaling* parameters. For example, there are various sizes for the same product which is processed. Just one cam relationship need be planned and then changing the values of *Offset* and *Scaling* fits the processing of products of different sizes.

The *MasterOffset* parameter is valid only when the master axis is in absolute or relative mode.

(*MasterAbsolute*=TRUE or FALSE). The *SlaveOffset* parameter is valid only as the slave axis is in absolute mode (*SlaveAbsolute*=TRUE). The *SlaveOffset* parameter is invalid as the slave axis is in relative mode (*SlaveAbsolute*=FALSE).

The position offset and scaling of the master axis and slave axis determine the actually executed cam relationship. The effect is described in the following example. The planned cam relationship is shown as the figure below.

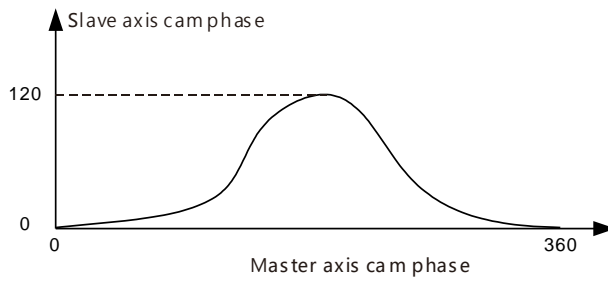

When the master axis and slave axis are both in absolute mode and the engagement begins, the master axis position and slave axis position are both 0. When there is no position offset and scaling (the offset and scaling are default values), the actual master axis position correspond to the actual slave axis position in the execution of the cam motion as shown in the following figure.

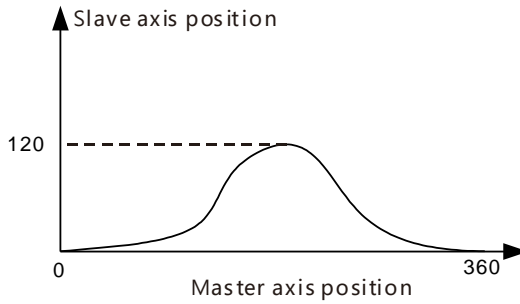

When the offset and scaling are not default values, the corresponding relationship between the actual master axis position and actual slave axis position are affected in the execution of the cam motion as below.

➤ **MasterOffset:0 and SlaveOffset:0 and the impact of MasterScaling and SlaveScaling on the cam relationship**

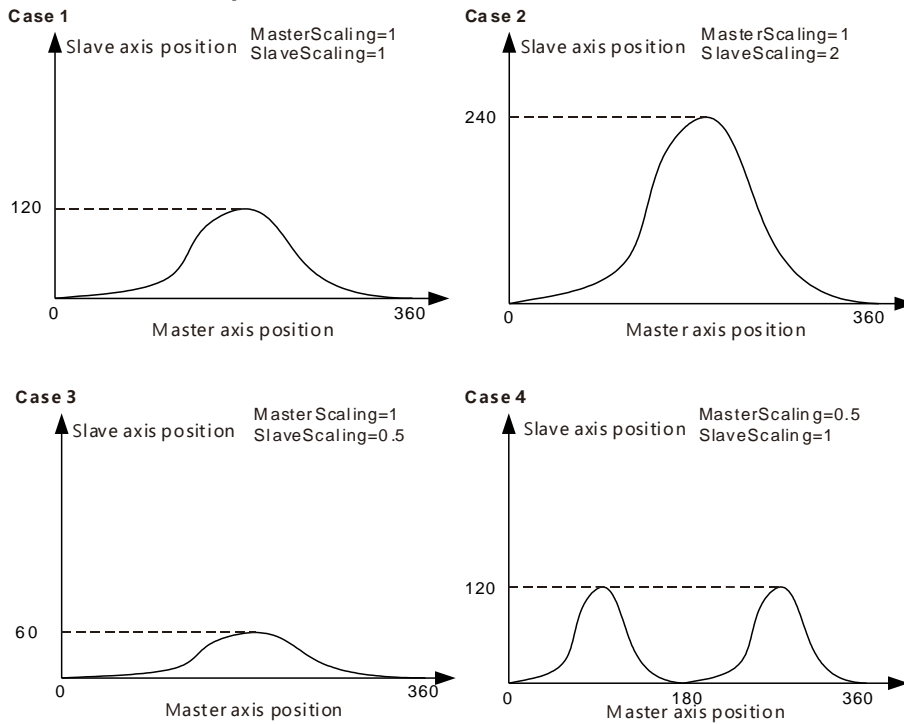

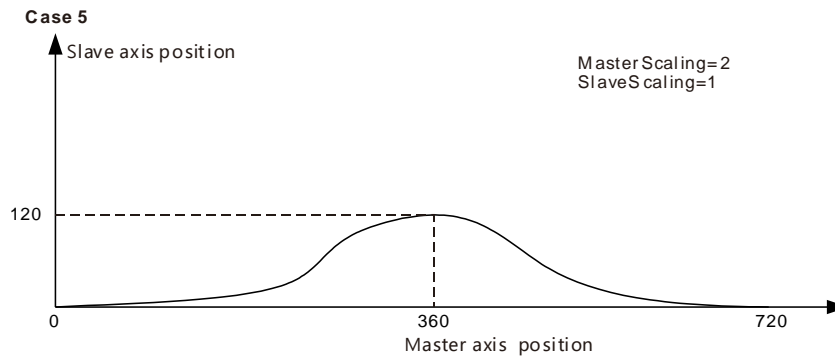

- Case 1 :** The actual cam relationship is consistent with the preplanned one as the values of *MasterScaling* and *SlaveScaling* are 1 and their offsets are 0.
- Case 2 :** The slave position corresponding to the master axis position is two times what is planned in the cam relationship as the value of *MasterScaling* is 1, *SlaveScaling* is 2 and their offsets are 0.
- Case 3 :** The slave position corresponding to the master axis position is 1/2 that in the planned cam relationship as the value of *MasterScaling* is 1, *SlaveScaling* is 0.5 and their offsets are 0.
- Case 4 :** The master axis position corresponding to the slave axis position is 1/2 what is planned as the value of *MasterScaling* is 0.5, *SlaveScaling* is 1 and their offsets are 0. If it is observed from the perspective of the cam phase, the master axis cam phase is 1/2 what is preplanned. That is, the master cam cycle changes from 360 to 180 ($180=360*0.5$) and the slave axis cam phase is unchanged.
- Case 5 :** The master axis position corresponding to the slave axis position is 2 times what is planned as the value of *MasterScaling* is 2, *SlaveScaling* is 1 and their offsets are 0. If it is observed from the perspective of the cam phase, the master axis cam phase is two times the original. That is, the master axis cam cycle changes from 360 to 720 ($720=360*2$) and the slave axis cam phase is unchanged.

➤ **MasterScaling:1 and SlaveScaling:1 and the impact of MasterOffset and SlaveOffset on the actually executed cam relationship**

MasterOffset means to make the actual axis position curve shifted horizontally in execution of the cam motion. *SlaveOffset* indicates to make the axis position curve shifted vertically in execution of the cam motion.

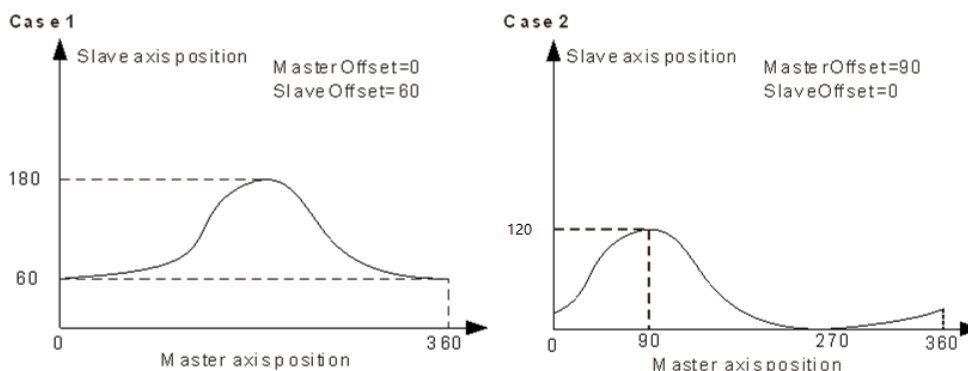

- Case 1 :** The slave axis position corresponding to the master axis position will add by 60 based on the planned position as *MasterScaling* and *SlaveScaling* are both 1, *MasterOffset* is 0 and *SlaveOffset* is 60.
For example, in the planned cam relationship, the master axis position 180 corresponds to the slave axis position 120 and in the actual execution, the

corresponding slave axis position is 180 ($180=120+60$).

Case 2 : The master axis position corresponding to the slave axis position will shift (add) by 90 based on the planned position as *MasterScaling* and *SlaveScaling* are 1, *MasterOffset* is 90 and *SlaveOffset* is 0.

For example, in the planned cam relationship, the master axis position 180 corresponds to the slave axis position 120 and in the actual execution, the master axis position 90 corresponds to the slave axis position 120 which is the slave axis position corresponded to by the master axis position 180 ($180=90+90$) in the planned cam relationship.

■ **StartMode**

In the engagement, the way how the slave axis moves is specified by the *StartMode* parameter. That is, *StartMode* works at stage 4 in the execution of the *MC_CamIn* instruction as shown in the following figure.

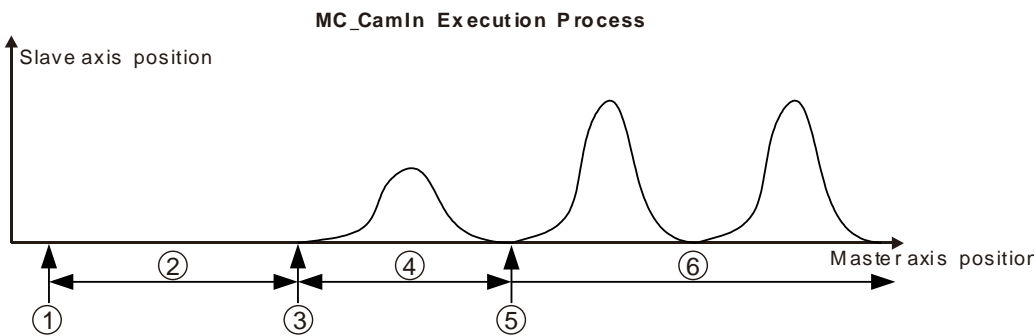

Stage 1: Trigger and execute the *MC_CamIn* instruction.

Stage 2: Wait for the start of the engagement.

Stage 3: The master axis reaches the position where the engagement begins and the slave axis starts to perform the engagement action.

Stage 4: The engagement is ongoing.

Stage 5: The engagement is completed and the master axis and slave axis achieve the synchronization.

Stage 6: The master axis and slave axis are in the synchronous motion.

The cam synchronization requires that the master axis cam phase and the slave axis cam phase meet the defined cam relationship. The engagement process is the process in which the slave axis moves toward the synchronous phase. The synchronous phase and the master axis cam phase meet the defined cam relationship. Since the axis cam phase is cyclic, every cam phase is corresponded to by multiple axis positions. When the engagement occurs, there are many selections for the expected synchronization position. And thus there are several engagement ways for option.

For example, when the engagement starts, the master axis cam phase and slave axis cam phase are 80 and 180 respectively as point O in the following figure. But the defined cam relationship requires that the slave axis cam phase is 40 and thus the synchronous position that the slave axis expects is 40 or 400 (Point A or point B in the following figure) at the moment. The engagement process from Point O to A or Point O to B can be selected via the *StartMode* parameter.

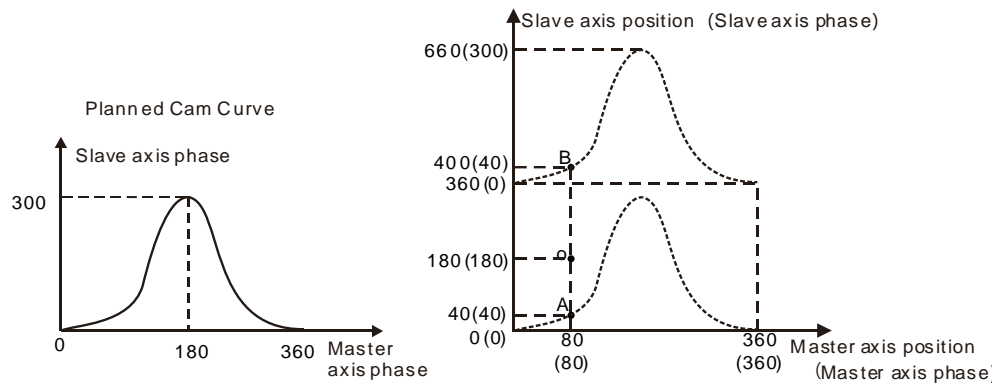

There are three modes of *StartMode* for selection: the shortest way (*mcRamplnShortest*), positive direction (*mcRamplnPositive*) and negative direction (*mcRamplnNegative*). Users can select the right engagement mode according to actual need.

➤ ***StartMode=0* (The shortest way)**

As *StartMode=0*, in the execution of the engagement action, the slave axis moves toward the position for synchronization by taking the shortest way. At the moment, the motion of the slave axis is affected by the *Velocity*, *Acceleration*, *Deceleration* and *Jerk* parameters.

➤ ***StartMode=1* (Positive direction)**

As *StartMode=1*, in the execution of the engagement action, the slave axis moves toward the position for synchronization in the positive direction. At the moment, the motion of the slave axis is affected by the *Velocity*, *Acceleration*, *Deceleration* and *Jerk* parameters.

➤ ***StartMode=-1* (Negative direction)**

As *StartMode=-1*, in the execution of the engagement action, the slave axis moves toward the position for synchronization in the negative direction. At the moment, the motion of the slave axis is affected by the *Velocity*, *Acceleration*, *Deceleration* and *Jerk* parameters.

For example, as the engagement begins, the master axis cam phase and slave axis cam phase are 80 and 180 respectively (as point O below). According to the defined cam relationship, the master axis cam phase is 80 and the slave axis cam phase is 40 (as point A or B below). If the value of *StartMode* is different, the way the slave axis moves is different in the engagement process.

StartMode=0 : The slave axis moves from point O to point A and the synchronization is achieved at point A since the distance from point O to point A is less than that from point O to point B.

StartMode=1 : The slave axis gradually moves from point O to point B in the positive direction.

StartMode=-1 : The slave axis gradually moves from point O to point A in the negative direction.

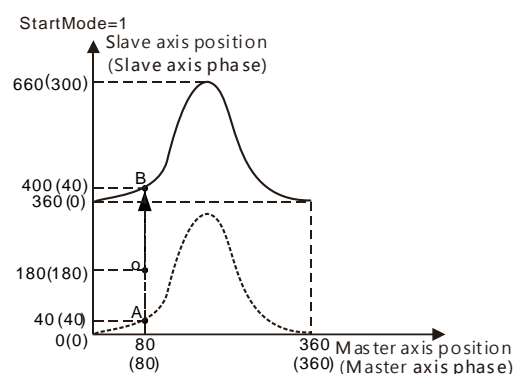
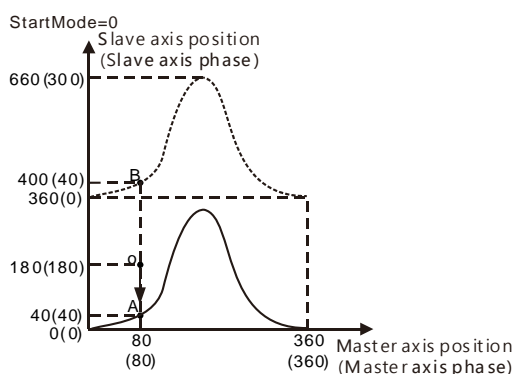

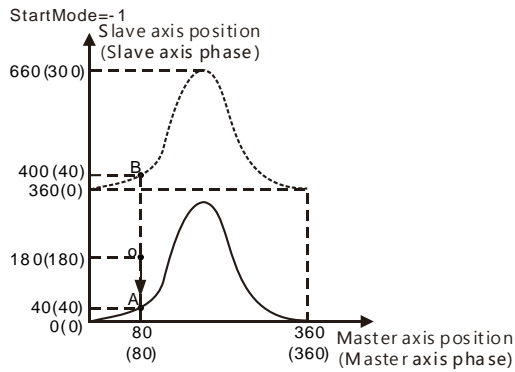

■ **Periodic/Non-periodic Cam Operation (Periodic)**

In the actual application of electronic cams, some may be executed periodically and some just need be executed for one cycle. The *Periodic* parameter is used for choosing one of the two cases for the electronic cam motion.

As *Periodic=TRUE*, the slave axis follows the master axis to periodically perform the cam motion till the cam relationship is disconnected.

As *Periodic=FALSE*, when the end point of the cam cycle is reached after the slave axis and master axis enter the synchronous cam motion, the cam relationship between the slave axis and master axis will be disconnected and the slave axis will stop moving immediately.

If the velocity at the end point of the planned cam relationship is not 0, the slave axis will constantly move at the disconnection speed after the disconnection of the cam relationship.

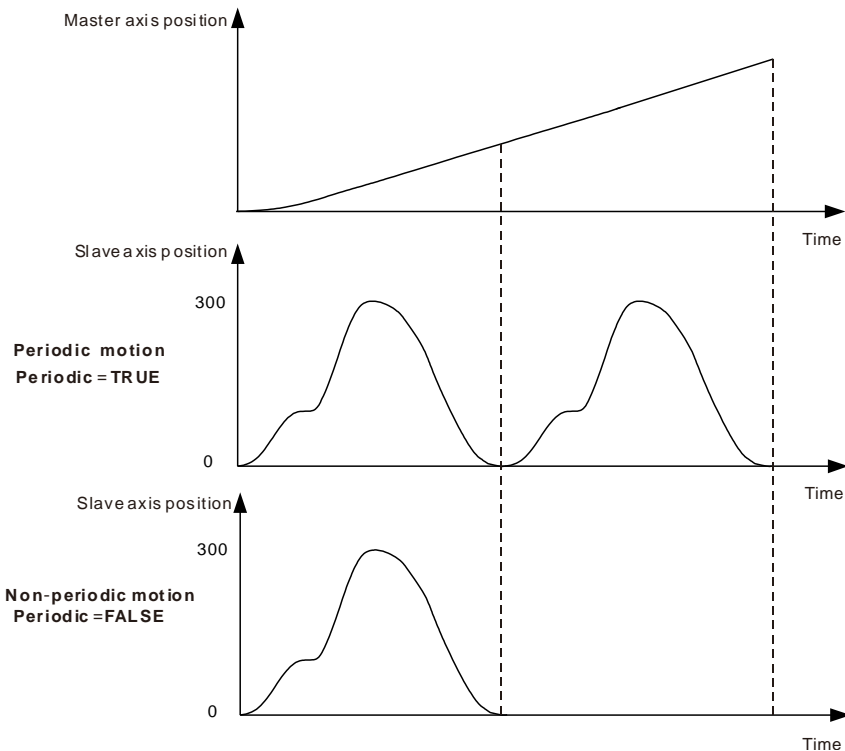

■ **The impact of other instructions on cam operation**

➤ **MC_CamOut**

The *MC_CamOut* instruction can be used to end the cam operation which is being carried out.

➤ **MC_SetPosition**

The *MC_SetPosition* instruction has no impact on the being executed motion instructions.

Thus, during cam operation, the execution of *MC_SetPosition* instruction for the master axis and slave axis will not affect the cam operation. If the cam operation is triggered after the *MC_SetPosition* instruction is executed, the cam will be affected by the axis position change which is incurred by using the *MC_SetPosition* instruction.

➤ ***MC_Stop* and *MC_Halt***

As the *MC_Stop* and *MC_Halt* instructions are executed on the slave axis, the *MC_CamIn* instruction is aborted, the cam relationship is disconnected and the slave axis decelerates till it stops.

➤ ***MC_Home***

The *MC_Home* instruction cannot be executed on the slave axis but the master axis. As the *MC_Home* instruction is executed on the master axis, the master axis position may have a great change in a very short time, which may cause the vibration of the slave axis. Therefore, the *MC_Home* instruction is recommended to execute after the synchronous relationship between the two axes is disconnected.

■ **Other precautions**

See the rule for different types of axes working as the master axis or slave axis in the cam relationship in the following table.

Axis type	As cam master axis	As cam slave axis
Servo real axis	OK	OK
Encoder	OK	NO
Virtual axis	OK	OK



Programming Example

- The execution effect of the *MC_CamIn* instruction is described in the following example.
 - The cam curve is planned as below.

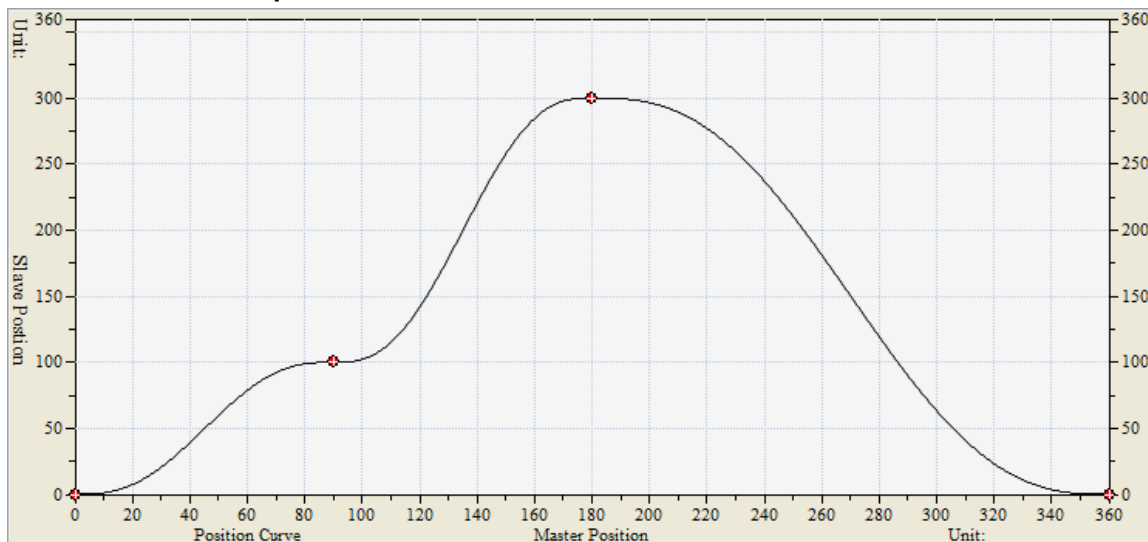

■ **Key points of the cam curve**

No.	Master axis position	Slave axis position	Velocity	Acceleration
1	0	0	0	0
2	90	100	0	0
3	180	300	0	0
4	360	0	0	0

■ **Explanation:**

Cam period of the master axis and slave axis	360
Master Scaling and SlaveScaling	1
MasterOffset and SlaveOffset	0
MasterAbsolute	Relative
SlaveAbsolute	Relative
Periodic	Periodic
ActivationPosition	Relative axis position:100
StartMode	The shortest way

■ The variable table and program

Variable name	Data type	Initial value
CamIn	MC_CamIn	
CamIn_Ex	BOOL	
CamIn_InSync	BOOL	
CamIn_EndOP	BOOL	
CamIn_Bsy	BOOL	
CamIn_Act	BOOL	
CamIn_Abt	BOOL	
CamIn_Err	BOOL	
CamIn_ErrID	WORD	
Vel	MC_MoveVelocity	
Vel_Ex	BOOL	
Vel_InVel	BOOL	
Vel_Bsy	BOOL	
Vel_Act	BOOL	
Vel_Abt	BOOL	
Vel_Err	BOOL	
Vel_ErrID	WORD	

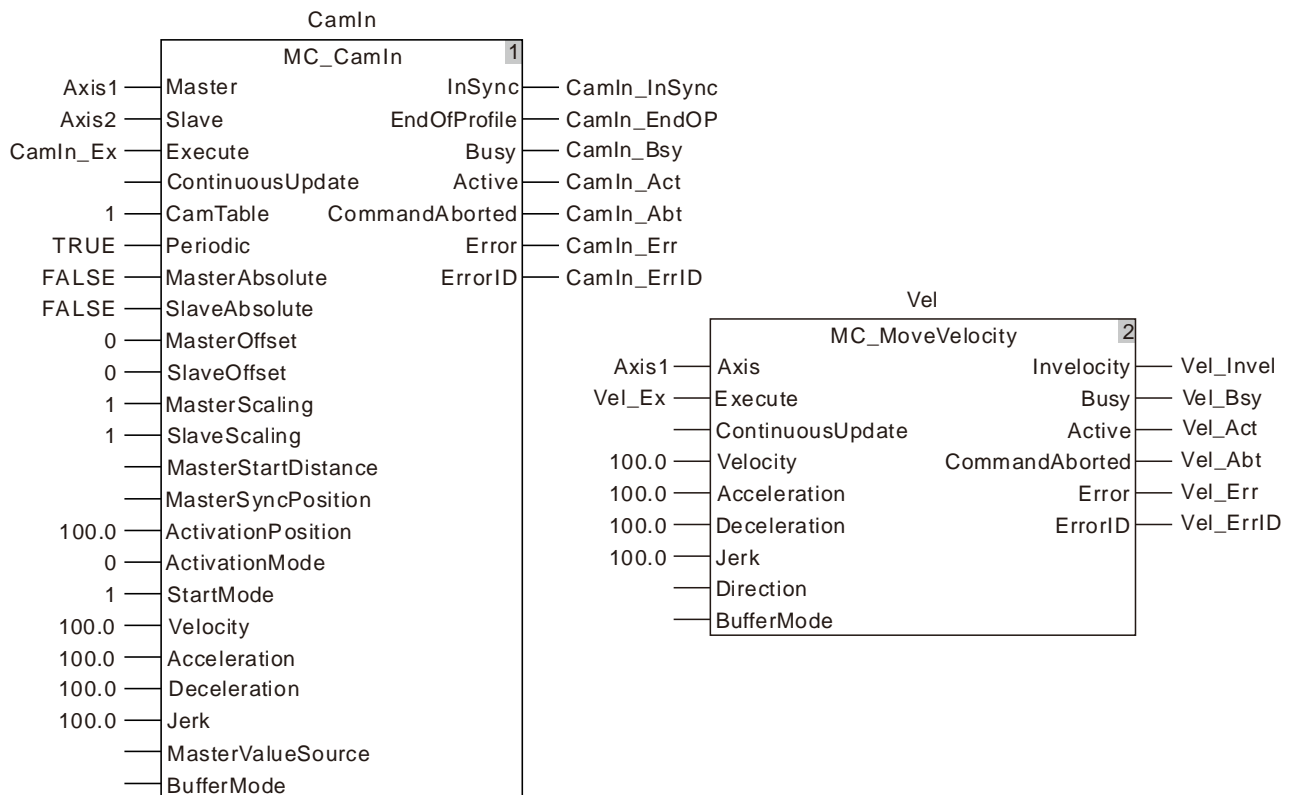

■ Motion curve and timing chart

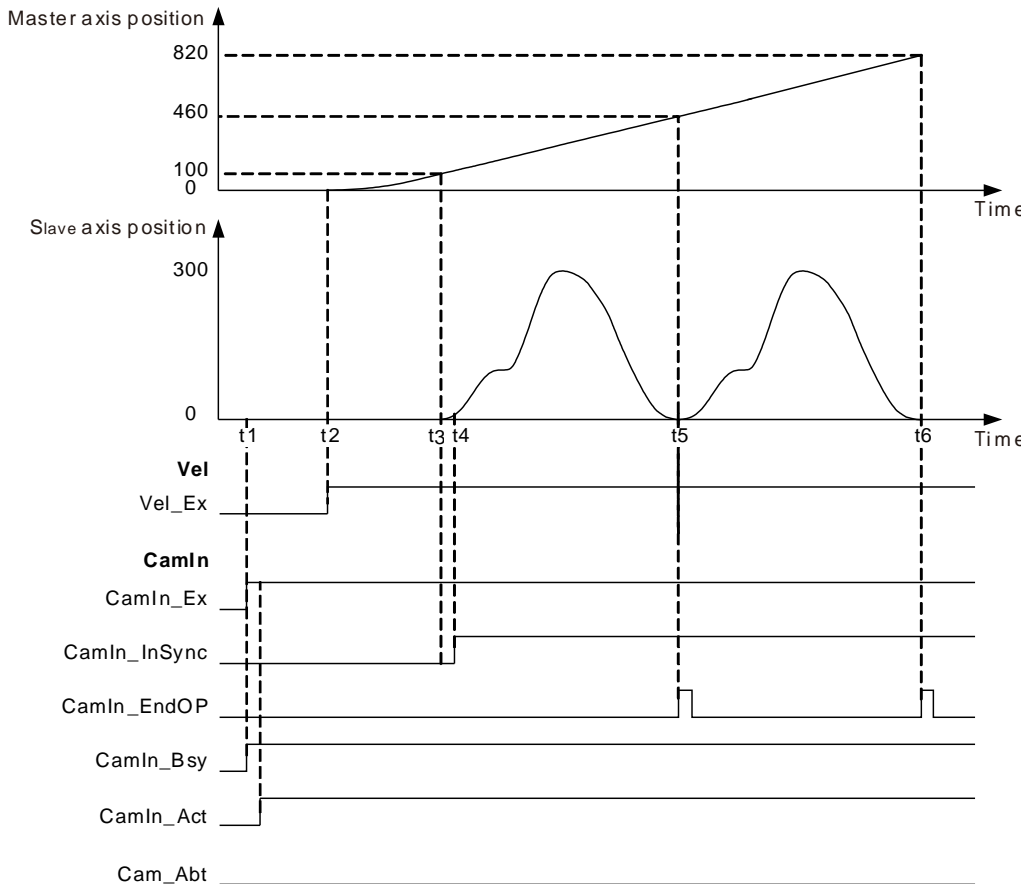

- ❖ As CamIn_Ex changes from FALSE to TRUE, the MC_CamIn instruction is executed and at the moment of t1, both of the master axis and slave axis positions are 0. The value of *ActivationPosition* is 100 and *ActivationMode* is 0, so the slave will not start to execute the engagement action until the master axis position is 100 (the master axis position at the time of $t1 + ActivationPosition$).
- ❖ As Vel_Ex changes from FALSE to TRUE, the MC_MoveVelocity instruction is executed and at the moment of t2, the master axis position is 0 and slave axis continues waiting for the start of the engagement. After that, the master axis will move from 0 in the positive direction under the control of the MC_MoveVelocity instruction.
- ❖ When the master axis passes 100, the position where the engagement begins is reached at the time of t3. The slave axis starts to perform the engagement action according to *StartMode* at the moment of t3. The synchronization is achieved at t4 and the *InSync* output parameter (CamIn1_InSync) changes from FALSE to TRUE.
- ❖ Whenever the synchronous motion reaches the end point in a cam period as shown at t5 and t6, the *EndOfProfile* output parameter (CamIn1_EndPro) will change to TRUE and it will change to FALSE after a program period.

11.4.6 MC_CamOut

FB/FC	Explanation	Applicable model
FB	MC_CamOut can disconnect the established electronic cam relationship.	DVP15MC11T DVP15MC11T-06

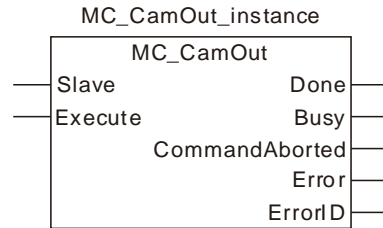

● Input Parameters

Parameter name	Function	Data type	Valid range (Default)	Validation timing
Slave	Specify the number of the slave axis which is to be disconnected from the cam relationship.	USINT	Refer to Functions of Section 2.2. (The variable value must be set)	When <i>Execute</i> changes from FALSE to TRUE
Execute	The instruction is executed when <i>Execute</i> changes from FALSE to TRUE.	BOOL	TRUE or FALSE (FALSE)	-

● Output Parameters

Parameter name	Function	Data type	Valid range
Done	TRUE when the instruction execution is completed.	BOOL	TRUE / FALSE
Busy	TRUE when the instruction is being executed.	BOOL	TRUE / FALSE
CommandAborted	TRUE when the instruction is aborted.	BOOL	TRUE / FALSE
Error	TRUE when there is an error in the execution of the instruction.	BOOL	TRUE / FALSE
ErrorID	Contains the error code when an error occurs. Please refer to the section 12.2.	WORD	

● Output Update Timing

Name	Timing for changing to TRUE	Timing for changing to FALSE
Done	◆ When the electronic cam relationship between the slave axis and master axis is disconnected.	◆ When <i>CommandAborted</i> changes to TRUE. ◆ When <i>Error</i> changes to TRUE.
Busy	◆ When <i>Execute</i> changes to TRUE.	◆ When <i>CommandAborted</i> changes to TRUE. ◆ When <i>Error</i> changes to TRUE.
CommandAborted	◆ When the instruction execution is aborted by other motion instruction.	◆ When <i>Execute</i> changes from TRUE to FALSE. ◆ <i>CommandAborted</i> is set to TRUE when the instruction is aborted by other instruction after <i>Execute</i> changes from TRUE to FALSE in the course of the instruction execution. One period later, <i>CommandAborted</i> changes to FALSE.

Name	Timing for changing to TRUE	Timing for changing to FALSE
Error	◆ When an error occurs in the instruction execution or the input parameters for the instruction are illegal.	◆ When <i>Execute</i> changes from TRUE to FALSE.

● **Output Update Timing Chart**

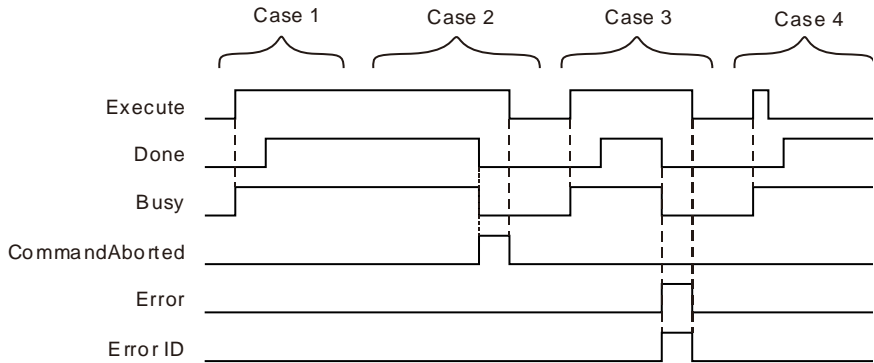

Case 1 : *Busy* changes to TRUE as *Execute* changes from FALSE to TRUE. One period later, *Done* changes to TRUE. *Busy* and *Done* remain TRUE after *Execute* changes from TRUE to FALSE.

Case 2 : When *Execute* is TRUE, *CommandAborted* changes to TRUE and meanwhile *Busy* and *Done* change to FALSE if the instruction is aborted by other instruction. When *Execute* changes from TRUE to FALSE, *CommandAborted* changes to FALSE.

Case 3 : As *Execute* changes from FALSE to TRUE and an error occurs (e.g. an axis is disabled), *Error* changes to TRUE and *ErrorID* shows corresponding error codes. Meanwhile *Busy* and *Done* change to FALSE. As *Execute* changes from TRUE to FALSE, *Error* changes to FALSE.

Case 4 : *Execute* changes from TRUE to FALSE as the instruction execution lasts for less than one period. After that, *Done* changes to TRUE and *Busy* remain TRUE as one period is reached.

● **Functions**

MC_CamOut is used for disconnecting the established electronic cam relationship. The instruction works on the slave axis in the cam operation and the slave axis will continue moving at the speed of when it is disconnected from the cam relationship.

MC_Halt or *MC_Stop* instructions can be executed on the slave axis so as to stop the slave axis motion. The slave axis will stop moving and the cam relationship will be disconnected after the execution of the *MC_Halt* instruction or *MC_Stop* instruction is completed.



Programming Example

- The execution effect of the *MC_CamOut* instruction is described in the following example. The cam curve is planned as below.

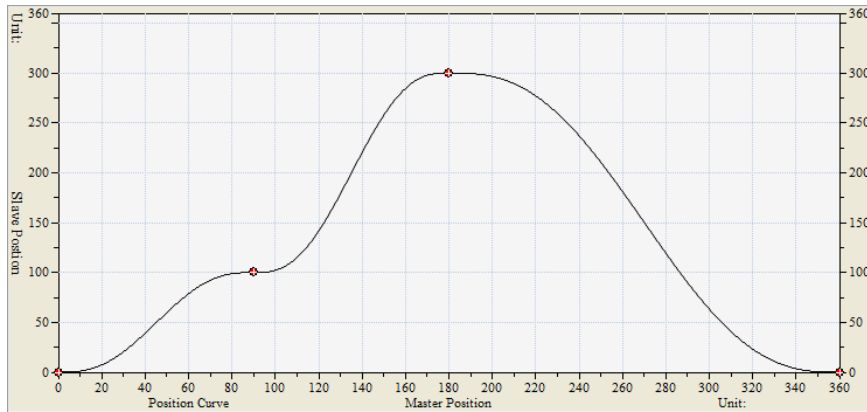

■ The key points of the cam curve

No.	Master axis position	Slave axis position	Velocity	Acceleration
1	0	0	0	0
2	90	100	0	0
3	180	300	0	0
4	360	0	0	0

■ Explanation:

Cam period of the master axis and slave axis	360
MasterScaling and SlaveScaling	1
MasterOffset and SlaveOffset	0
MasterAbsolute	Relative
SlaveAbsolute	Relative
Periodic	Periodic
ActivationPosition	Relative axis position: 100
StartMode	The shortest way

■ The variable table and program

Variable name	Data type	Initial value
CamIn	MC_CamIn	
CamIn_Ex	BOOL	
CamIn_InSync	BOOL	
CamIn_EndOP	BOOL	
CamIn_Bsy	BOOL	
CamIn_Act	BOOL	
CamIn_Abt	BOOL	
CamIn_Err	BOOL	
CamIn_ErrID	WORD	
Vel	MC_MoveVelocity	
Vel_Ex	BOOL	
Vel_InVel	BOOL	
Vel_Bsy	BOOL	
Vel_Act	BOOL	

Variable name	Data type	Initial value
Vel_Abt	BOOL	
Vel_Err	BOOL	
Vel_ErrID	WORD	
CamOut	MC_CamOut	
CamOut_Ex	BOOL	
CamOut_Done	BOOL	
CamOut_Bsy	BOOL	
CamOut_Abt	BOOL	
CamOut_Err	BOOL	
CamOut_ErrID	WORD	

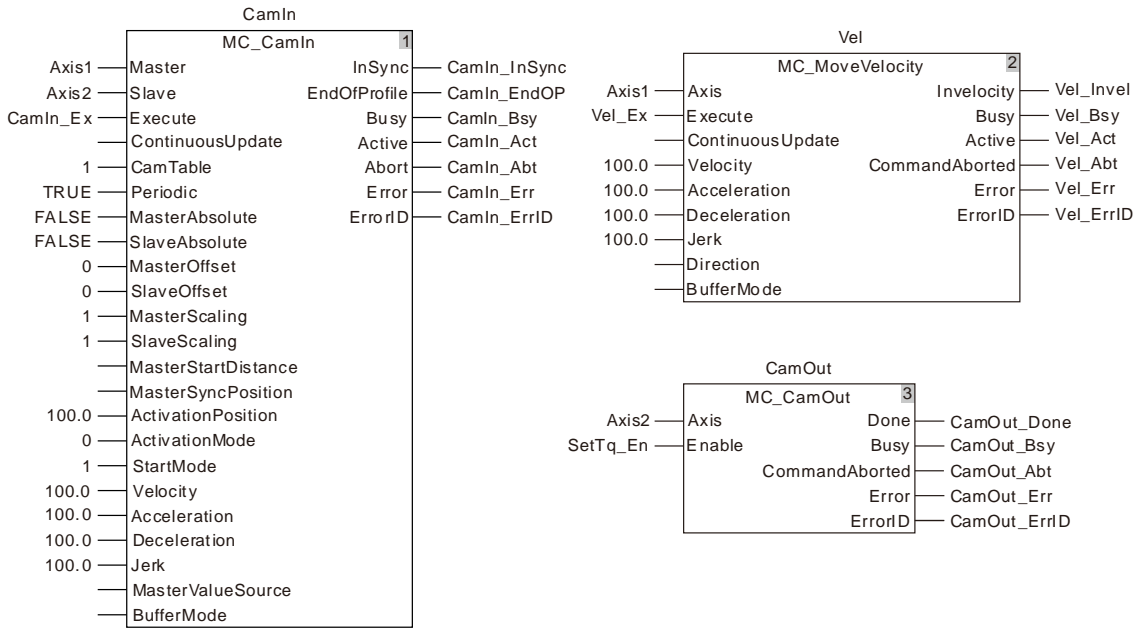

■ Motion curve and timing chart

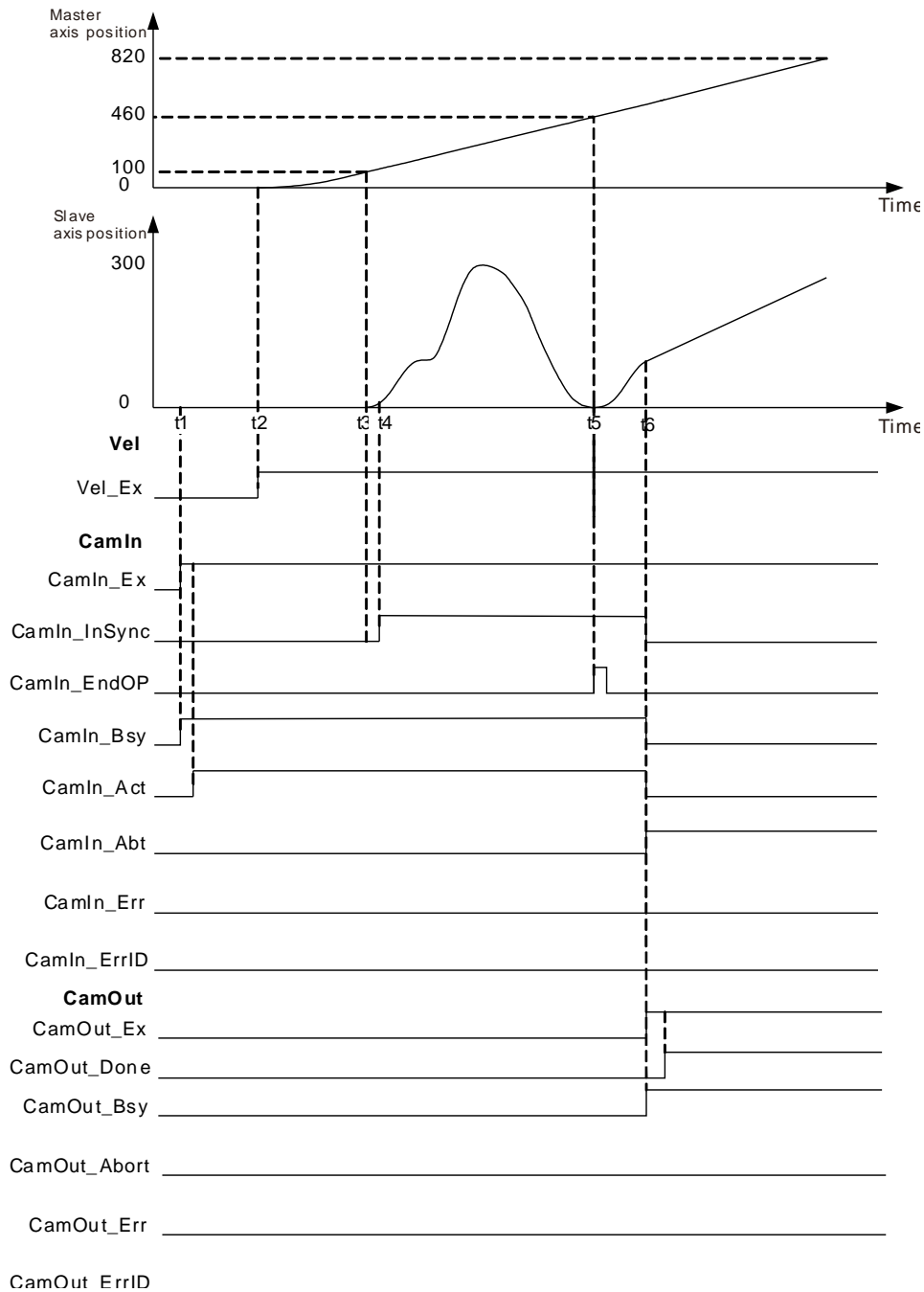

- ❖ As CamIn_Ex changes from FALSE to TRUE at t1, the MC_CamIn instruction is executed and at the moment, both of the master axis and slave axis positions are 0. The value of *ActivationPosition* is 100 and *ActivationMode* is 0, so the slave axis will not start to execute the engagement action until the master axis position is 100 (the master axis position at t1 + *ActivationPosition*).
- ❖ As Vel_Ex changes from FALSE to TRUE at t2, the MC_MoveVelocity instruction execution starts. At the moment, the master axis position is 0 and the slave axis continues waiting for the execution of the engagement action. After that, the master axis moves from 0 in the positive direction under the control of the MC_MoveVelocity instruction.

- ❖ The position where the engagement starts is reached as the master axis passes 100 at t3. The slave axis starts to perform the engagement action according to *StartMode* at t3. The synchronization is achieved at t4 and the *InSync* output parameter (CamIn1_InSync) changes from FALSE to TRUE.
- ❖ During the synchronous cam motion in which the slave axis follows the motion of the master axis, by executing the MC_CamOut instruction, the cam relationship is disconnected at t6. After the MC_CamOut instruction is executed, the slave axis will keep moving at the speed it has when the slave axis is disconnected from the cam relationship.

11.4.7 DMC_CamReadPoint

FB/FC	Explanation	Applicable model
FB	DMC_CamReadPoint reads the information of a cam point.	DVP15MC11T DVP15MC11T-06

DMC_CamReadPoint_instance

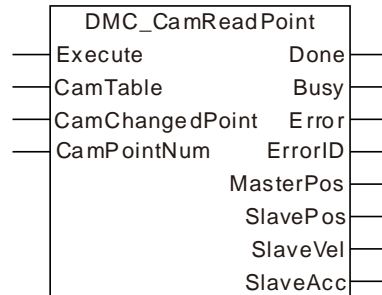

● Input Parameters

Parameter name	Function	Data type	Valid range (Default)	Validation timing
Execute	The instruction is executed when <i>Execute</i> changes from FALSE to TRUE.	BOOL	TRUE or FALSE (FALSE)	-
CamTable	The number of the cam table based on which the cam relationship between the master axis and slave axis is built.	USINT	1~64 (The variable value must be set)	When <i>Execute</i> changes from FALSE to TRUE.
CamChangedPoint	If <i>CamChangedPoint</i> is FALSE, the instruction reads the cam point information which is before the cam point has been modified. If <i>CamChangedPoint</i> is TRUE, the instruction reads the cam point information which is after the cam point has been modified.	BOOL	TRUE/FALSE	When <i>Execute</i> changes from FALSE to TRUE.
CamPointNum	The number of the cam point which is to be selected.	UINT	1~2048 (0)	When <i>Execute</i> changes from FALSE to TRUE.

● Output Parameters

Parameter name	Function	Data type	Valid range
Done	TRUE when the instruction execution is completed.	BOOL	TRUE/FALSE
Busy	TRUE when the instruction is being executed.	BOOL	TRUE / FALSE
Error	TRUE when there is an error in the execution of the instruction.	BOOL	TRUE / FALSE
ErrorID	Contains the error code when an error occurs. Please refer to section 12.2.	WORD	
MasterPos	The position of the master axis of the selected electronic cam point.	LREAL	0, positive number

Parameter name	Function	Data type	Valid range
SlavePos	The position of the slave axis of the selected electronic cam point.	LREAL	0, positive number
SlaveVel	The velocity of the slave axis of the selected electronic cam point.	LREAL	0, positive number
SlaveAcc	The acceleration of the slave axis of the selected electronic cam point.	LREAL	0, positive number

● **Output Update Timing**

Name	Timing for changing to TRUE	Timing for changing to FALSE
Done	◆ When the instruction execution is completed.	◆ When <i>Execute</i> changes to FALSE.
Busy	◆ When <i>Execute</i> is TRUE.	◆ When <i>Done</i> changes to TRUE. ◆ When <i>Error</i> changes to TRUE.
Error	◆ When any of the input parameters is illegal.	◆ When <i>Execute</i> changes from TRUE to FALSE.

● **Output Update Timing Chart**

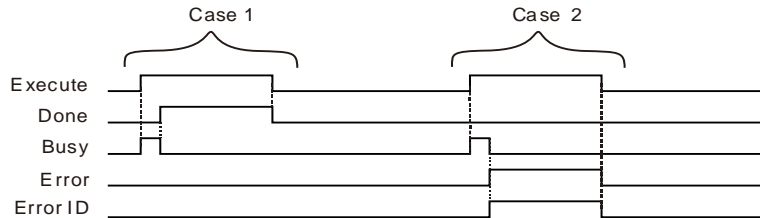

Case 1 : When *Execute* changes from FALSE to TRUE, *Busy* changes to TRUE. When the instruction execution is completed, *Done* changes to TRUE and *Busy* changes to FALSE. When *Execute* changes to FALSE, *Done* changes to FALSE.

Case 2 : When an error occurs, *Error* changes to TRUE and *ErrorID* shows corresponding error code. When *Execute* changes from TRUE to FALSE, *Error* changes to FALSE and the value of *ErrorID* is cleared to 0.

● **Functions**

DMC_CamReadPoint reads the information of a cam point in an electronic cam table.

If *CamChangedPoint* is FALSE, the instruction reads the parameters of a cam point which is before the cam point information is modified by using DMC_CamSet.

If *CamChangedPoint* is TRUE, the instruction reads the parameters of a cam point which is after the cam point information is modified by using DMC_CamSet.



Programming Example

1. **The variable table and program**

Variable name	Data type	Initial value
CamWr	DMC_CamWritePoint	
CamWr_Ex	BOOL	FALSE
CamWr_CT	USINT	1
CamWr_CP	UINT	2
CamWr_MP	LREAL	180.0
CamWr_SP	LREAL	540.0
CamWr_SV	LREAL	0.0
CamWr_SA	LREAL	0.0

Variable name	Data type	Initial value
CamWr_Done	BOOL	
CamWr_Bsy	BOOL	
CamWr_Err	BOOL	
CamWr_ErrID	WORD	
CamRe	DMC_CamReadPoint	
CamRe_Ex	BOOL	FALSE
CamRe_CT	USINT	1
CamRe_CHP	BOOL	TRUE
CamRe_CPN	UINT	2
CamRe_Done	BOOL	
CamRe_Bsy	BOOL	
CamRe_Err	BOOL	
CamRe_ErrID	WORD	
CamRe_MP	LREAL	
CamRe_SP	LREAL	
CamRe_SV	LREAL	
CamRe_SA	LREAL	

CamWr

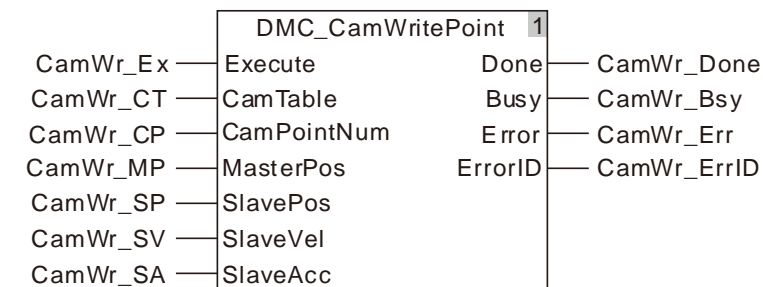

CamRe

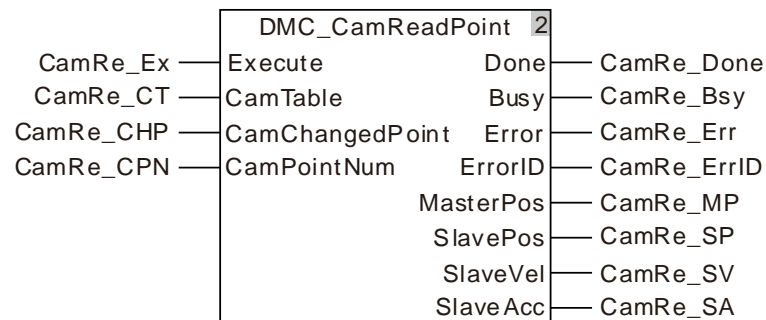

2. The cam curve

11

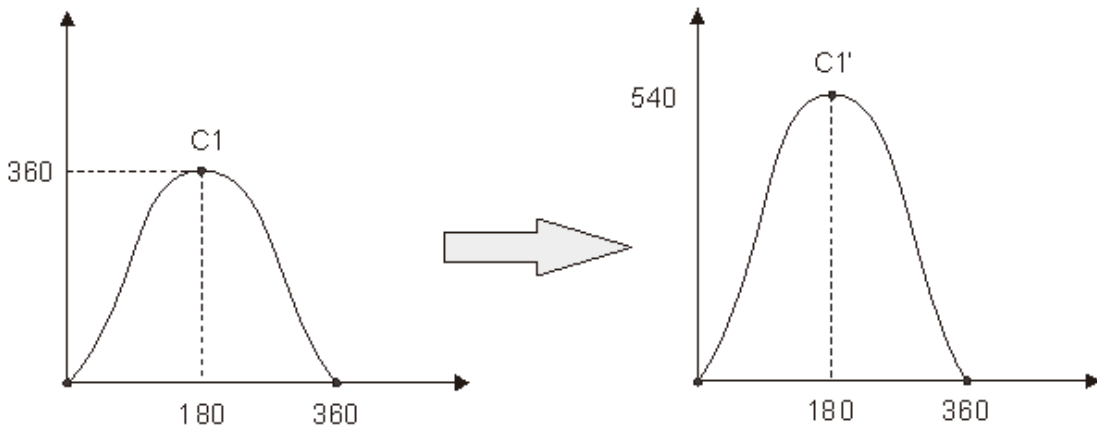

The cam curve C1 is changed to C1'.

- ◆ There are three cam points in the cam curve. When CamWr_Ex changes to TRUE, DMC_CamWritePoint is executed. When CamWr_Done changes to TRUE, it indicates that writing cam point information is finished. It is the second cam point of which the information is written.
- ◆ When CamRe_Ex changes to TRUE, DMC_CamReadPoint is executed. When the parameter *CamChangedPoint* (variable: CamRe_CHP) changes to FALSE, the cam point information that the instruction reads is the cam point information before writing is done as shown in the following table.

No.	Master axis position	Slave axis position	Velocity	Acceleration
2	180.0	360.0	0.0	0.0

- ◆ When the parameter *CamChangedPoint* (variable: CamRe_CHP) changes to TRUE, the cam point information that the instruction reads is the cam point information after writing is done as shown in the following table.

No.	Master axis position	Slave axis position	Velocity	Acceleration
2	180.0	540.0	0.0	0.0

11.4.8 DMC_CamWritePoint

FB/FC	Explanation	Applicable model
FB	DMC_CamWritePoint is used for setting parameters of one cam point.	DVP15MC11T DVP15MC11T-06

DMC_CamWritePoint_instance

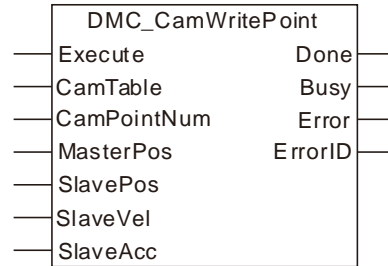

● Input Parameters

Parameter name	Function	Data type	Valid range (Default)	Validation timing
Execute	The instruction is executed when <i>Execute</i> changes from FALSE to TRUE.	BOOL	TRUE or FALSE (FALSE)	-
CamTable	The number of the cam table based on which the cam relationship between the master axis and slave axis is built.	USINT	1~64 (The variable value must be set)	When <i>Execute</i> changes from FALSE to TRUE.
CamPointNum	The number of the cam point which is set.	UINT	1~2048 (0)	When <i>Execute</i> changes from FALSE to TRUE.
MasterPos	The position of the master axis of the cam point which is set.	LREAL	0, positive number	
SlavePos	The position of the slave axis of the cam point which is set.	LREAL	0, positive number	
SlaveVel	The velocity of the slave axis of the cam point which is set.	LREAL	0, positive number	
SlaveAcc	The acceleration of the slave axis of the cam point which is set.	LREAL	0, positive number	

● Output Parameters

Parameter name	Function	Data type	Valid range
Done	TRUE when the instruction execution is completed.	BOOL	TRUE/FALSE
Busy	TRUE when the instruction is being executed.	BOOL	TRUE / FALSE
Error	TRUE when there is an error in the execution of the instruction.	BOOL	TRUE / FALSE

Parameter name	Function	Data type	Valid range
ErrorID	Contains the error code when an error occurs. Please refer to section 12.2.	WORD	

● **Output Update Timing**

Name	Timing for changing to TRUE	Timing for changing to FALSE
Done	◆ When the instruction execution is completed.	◆ When <i>Execute</i> changes to FALSE.
Busy	◆ When <i>Execute</i> is TRUE.	◆ When <i>Done</i> changes to TRUE. ◆ When <i>Error</i> changes to TRUE.
Error	◆ When any of the input parameters is illegal.	◆ When <i>Execute</i> changes from TRUE to FALSE.

● **Output Update Timing Chart**

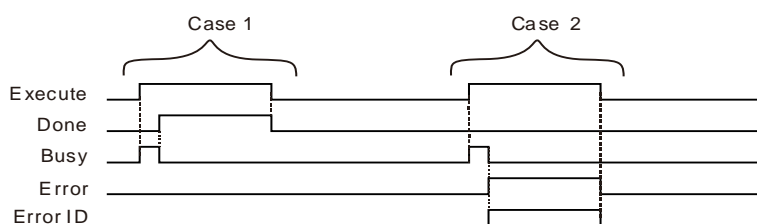

Case 1 : When *Execute* changes from FALSE to TRUE, *Busy* changes to TRUE. When the instruction execution is completed, *Done* changes to TRUE and *Busy* changes to FALSE. When *Execute* changes to FALSE, *Done* changes to FALSE.

Case 2 : When an error occurs, *Error* changes to TRUE and *ErrorID* shows corresponding error code. When *Execute* changes from TRUE to FALSE, *Error* changes to FALSE and the value of *ErrorID* is cleared to 0.

● **Functions**

DMC_CamWritePoint is used for setting parameters of a cam point in an electronic cam table. The new cam curve will not be effective immediately after the setting is over until the DMC_CamSet instruction is executed. Refer to Programming Example in section 11.4.9 DMC_CamSet for the example on how to use the instruction.

11.4.9 DMC_CamSet

FB/FC	Explanation	Applicable model
FB	DMC_CamSet is used for making the modified cam point information effective.	DVP15MC11T DVP15MC11T-06

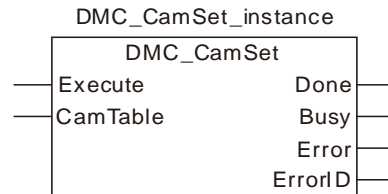

● Input Parameters

Parameter name	Function	Data type	Valid range (Default)	Validation timing
Execute	The instruction is executed when <i>Execute</i> changes from FALSE to TRUE.	BOOL	TRUE or FALSE (FALSE)	-
CamTable	The number of the cam table based on which the cam relationship between the master axis and slave axis is built.	USINT	1~64 (The variable value must be set)	When <i>Execute</i> changes from FALSE to TRUE.

● Output Parameters

Parameter name	Function	Data type	Valid range
Done	TRUE when the instruction execution is completed.	BOOL	TRUE/FALSE
Busy	TRUE when the instruction is being executed.	BOOL	TRUE / FALSE
Error	TRUE when there is an error in the execution of the instruction.	BOOL	TRUE / FALSE
ErrorID	Contains the error code when an error occurs. Please refer to section 12.2.	WORD	

● Output Update Timing

Name	Timing for changing to TRUE	Timing for changing to FALSE
Done	◆ When the instruction execution is completed.	◆ When <i>Execute</i> changes to FALSE.
Busy	◆ When <i>Execute</i> is TRUE.	◆ When <i>Done</i> changes to TRUE. ◆ When <i>Error</i> changes to TRUE.
Error	◆ When any of the input parameters is illegal.	◆ When <i>Execute</i> changes from TRUE to FALSE.

● **Output Update Timing Chart**

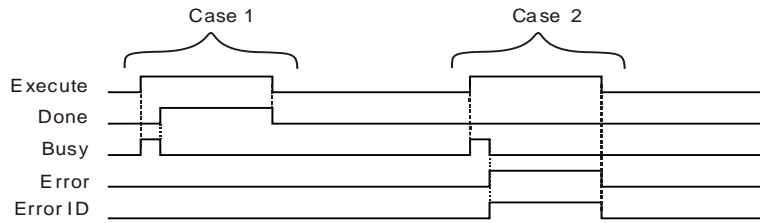

Case 1 : When *Execute* changes from FALSE to TRUE, *Busy* changes to TRUE. When the instruction execution is completed, *Done* changes to TRUE and *Busy* changes to FALSE. When *Execute* changes to FALSE, *Done* changes to FALSE.

Case 2 : When an error occurs, *Error* changes to TRUE and *ErrorID* shows corresponding error code. When *Execute* changes from TRUE to FALSE, *Error* changes to FALSE and the value of *ErrorID* is cleared to 0.

● **Functions**

DMC_CamSet is used for making the set cam point information effective. At first, use the DMC_CamWritePoint instruction to set corresponding cam point information in an electronic cam table. Then execute the DMC_CamSet instruction to make the new cam point information effective.

If the DMC_CamSet instruction is executed after the MC_CamIn instruction is executed, the cam curve after being modified will be effective in the next cycle.

If the DMC_CamSet instruction is executed before the MC_CamIn instruction is executed, the cam curve after being modified will take effect immediately.

● **Precaution**

If DMC_CamSet is used for making a modified cam curve effective, make sure that the cam curve is called for use by one MC_CamIn instruction at most. If the cam curve is called for use by multiple MC_CamIn instructions, the timing for making the set cam curve effective is not sure after DMC_CamSet is executed.



Programming Example

1. **The variable table and program**

Variable name	Data type	Initial value
CamWr	DMC_CamWritePoint	
CamWr_Ex	BOOL	FALSE
CamWr_CT	USINT	1
CamWr_CP	UINT	2
CamWr_MP	LREAL	180.0
CamWr_SP	LREAL	540.0
CamWr_SV	LREAL	0.0
CamWr_SA	LREAL	0.0
CamWr_Done	BOOL	
CamWr_Bsy	BOOL	
CamWr_Err	BOOL	
CamWr_ErrID	WORD	
CamSe	DMC_CamSet	
CamSe_CT	USINT	1
CamSe_Done	BOOL	

Variable name	Data type	Initial value
CamSe_Bsy	BOOL	
CamSe_Err	BOOL	
CamSe_ErrID	WORD	

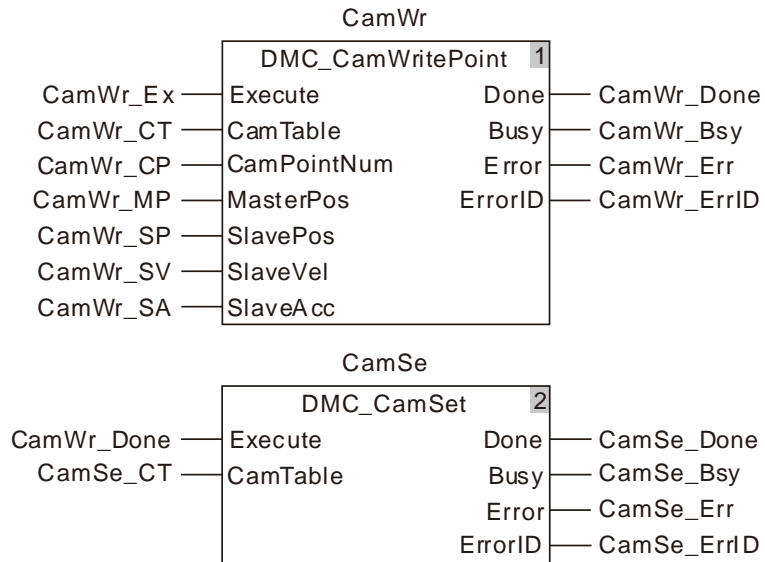

2. Cam Curve

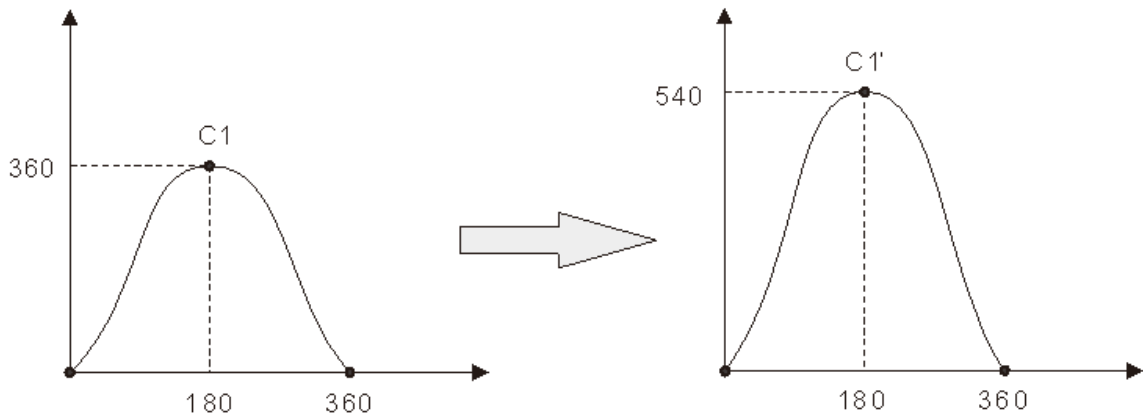

There are three cam points in the cam curve. Change curve C1 into curve C1'.

❖ The cam point information before modification:

No.	Master axis position	Slave axis position	Velocity	Acceleration
1	0.0	0.0	0.0	0.0
2	180.0	360.0	0.0	0.0
3	360.0	0.0	0.0	0.0

It can be seen from the curve above that the second cam point is modified. The cam curve is changed by executing DMC_CamWritePoint first and then executing DMC_CamSet in the program above.

❖ The cam point information after modification:

No.	Master axis position	Slave axis position	Velocity	Acceleration
1	0.0	0.0	0.0	0.0
2	180.0	540.0	0.0	0.0
3	360.0	0.0	0.0	0.0

3. Sequence Chart:

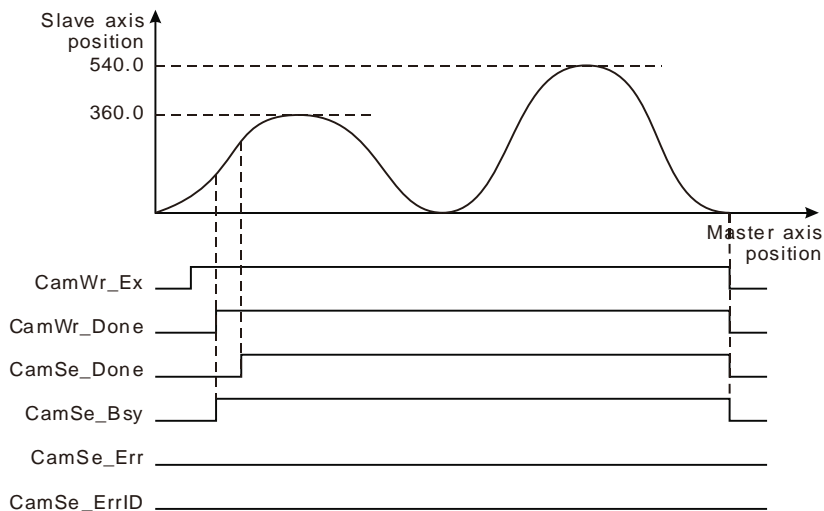

- ◆ When CamWr_Ex changes from FALSE to TRUE, DMC_CamWritePoint is executed. When CamWr_Done changes to TRUE, setting cam point information is finished.
- ◆ When CamWr_Done changes from FALSE to TRUE, DMC_CamSet is executed. When CamSe_Done changes to TRUE, the execution of DMC_CamSet is finished. The cam curve after being modified will take effect in the next cycle after current cam cycle is over.

11.4.10 DMC_CamReadTappetStatus

FB/FC	Explanation	Applicable model
FB	DMC_CamReadTappetStatus is used for reading the status of multiple tappet points.	DVP15MC11T DVP15MC11T-06

DMC_CamReadTappetStatus_instance

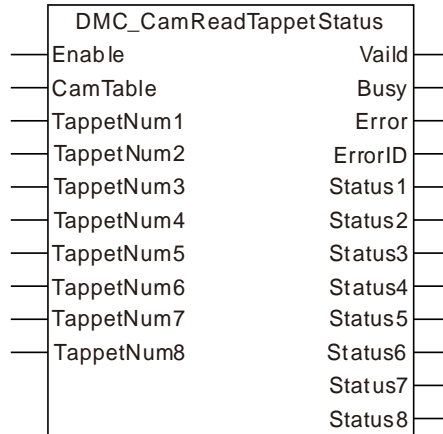

● Input Parameters

Parameter name	Function	Data type	Valid range (Default)	Validation timing
Enable	The instruction is executed when <i>Enable</i> changes from FALSE to TRUE.	BOOL	TRUE or FALSE (FALSE)	When <i>Enable</i> is TRUE.
CamTable	The number of the cam table based on which the cam relationship between the master axis and slave axis is built.	USINT	1~64 (The variable value must be set)	When Enable is TRUE.
TappetNum1	The number of the first tappet point	UINT	1~128 (The variable value must be set)	When <i>Enable</i> is TRUE.
TappetNum2	The number of the second tappet point	UINT	1~128 (The variable value must be set)	When Enable is TRUE.
TappetNum3	The number of the third tappet point	UINT	1~128 (The variable value must be set)	When <i>Enable</i> is TRUE.
TappetNum4	The number of the forth tappet point	UINT	1~128 (The variable value must be set)	When Enable is TRUE.
TappetNum5	The number of the fifth tappet point.	UINT	1~128 (The variable value must be set)	When Enable is TRUE.
TappetNum6	The number of the sixth tappet point	UINT	1~128 (The variable value must be set)	When <i>Enable</i> is TRUE.

Parameter name	Function	Data type	Valid range (Default)	Validation timing
TappetNum7	The number of the seventh tappet point.	UINT	1~128 (The variable value must be set)	When Enable is TRUE.
TappetNum8	The number of the eighth tappet point.	UINT	1~128 (The variable value must be set)	When <i>Enable</i> is TRUE.

● Output Parameters

Parameter name	Function	Data type	Valid range
Valid	TRUE when the output of the instruction is valid.	BOOL	TRUE / FALSE
Busy	TRUE when the instruction is being executed.	BOOL	TRUE / FALSE
Error	TRUE when there is an error in the execution of the instruction.	BOOL	TRUE / FALSE
ErrorID	Contains the error code when an error occurs. Please refer to section 12.2.	WORD	
Status1	The status of the first tappet point.	BOOL	TRUE/FALSE
Status2	The status of the second tappet point.	BOOL	TRUE/FALSE
Status3	The status of the third tappet point.	BOOL	TRUE/FALSE
Status4	The status of the fourth tappet point.	BOOL	TRUE/FALSE
Status5	The status of the fifth tappet point.	BOOL	TRUE/FALSE
Status6	The status of the sixth tappet point.	BOOL	TRUE/FALSE
Status7	The status of the seventh tappet point.	BOOL	TRUE/FALSE
Status8	The status of the eighth tappet point.	BOOL	TRUE/FALSE

● Output Update Timing

Name	Timing for changing to TRUE	Timing for changing to FALSE
Valid	◆ When the instruction execution is completed.	◆ When <i>Enable</i> changes to FALSE.
Busy	◆ When <i>Enable</i> is TRUE.	◆ When <i>Done</i> changes to TRUE. ◆ When <i>Error</i> changes to TRUE.
Error	◆ When any of the input parameters is illegal.	◆ When <i>Enable</i> changes from TRUE to FALSE.

● Output Update Timing Chart

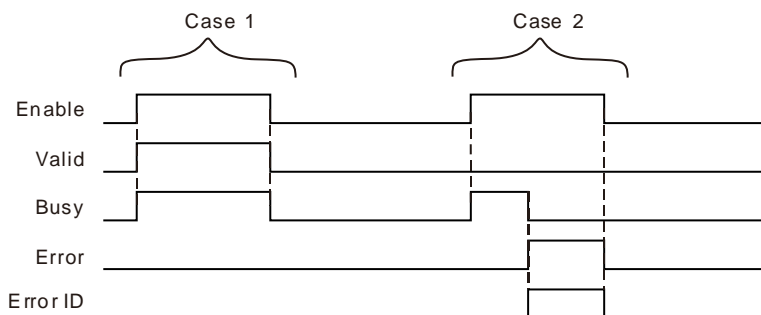

Case 1 : When *Enable* changes from FALSE to TRUE, *Valid* and *Busy* change to TRUE. When *Enable* changes to FALSE, *Valid* and *Busy* change to FALSE.

Case 2 : When an error occurs, *Error* changes to TRUE and *ErrorID* shows corresponding error code. Meanwhile *Busy* changes to FALSE. *Error* changes to FALSE when *Enable* changes from TRUE to FALSE and then the value of *ErrorID* is cleared to 0.

- **Functions**

DMC_CamReadTappetStatus is used for reading the status of eight tappet points.

The DMC_CamReadTappetStatus instruction is executed to read the status of the tappet points when the master axis passes the tappet points in the positive direction or in the negative direction. The status of every tappet point is determined by the setting of every tappet point. The status of every tappet point will change to FALSE when the master axis passes the final cam point in the positive direction or when the master axis passes the initial cam point in the negative direction.



Programming Example

1. The variable table and program

Variable name	Data type	Initial value
RTS	DMC_CamReadTappetStatus	
RTS_En	BOOL	FALSE
RTS_CT	USINT	1
RTS_TN1	UINT	1
RTS_TN2	UINT	2
RTS_TN3	UINT	3
RTS_TN4	UINT	4
RTS_TN5	UINT	5
RTS_TN6	UINT	6
RTS_TN7	UINT	7
RTS_TN8	UINT	8
RTS_Va	BOOL	
RTS_Bsy	BOOL	
RTS_Err	BOOL	
RTS_ErrID	WORD	
RTS_Sta1	BOOL	
RTS_Sta2	BOOL	
RTS_Sta3	BOOL	
RTS_Sta4	BOOL	
RTS_Sta5	BOOL	
RTS_Sta6	BOOL	
RTS_Sta7	BOOL	
RTS_Sta8	BOOL	

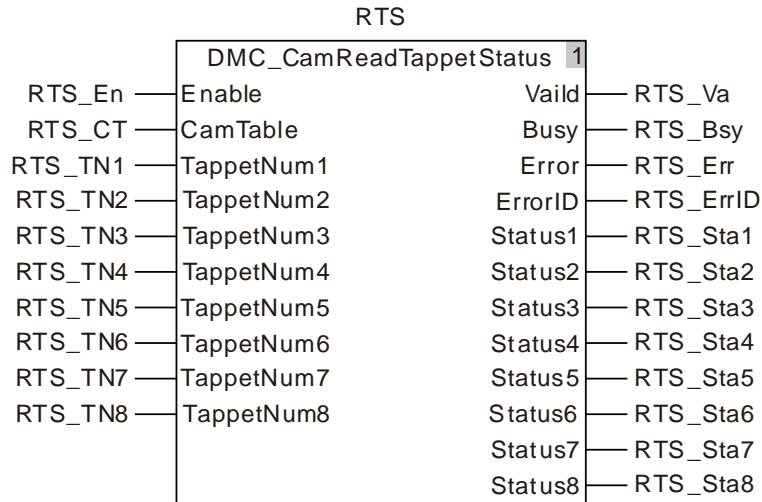

1. Table of tappet points

Index	Master axis position	Slave axis position	Passed in the positive direction	Passed in the negative direction
1	50.0	150.0	PositiveOn	NegativeOff
2	100.0	180.0	PositiveDisable	NegativeOff
3	180.0	250.0	PositiveOff	NegativeOff
4	300.0	100.0	PositiveInvert	NegativeOff

2. Position curve and sequence chart

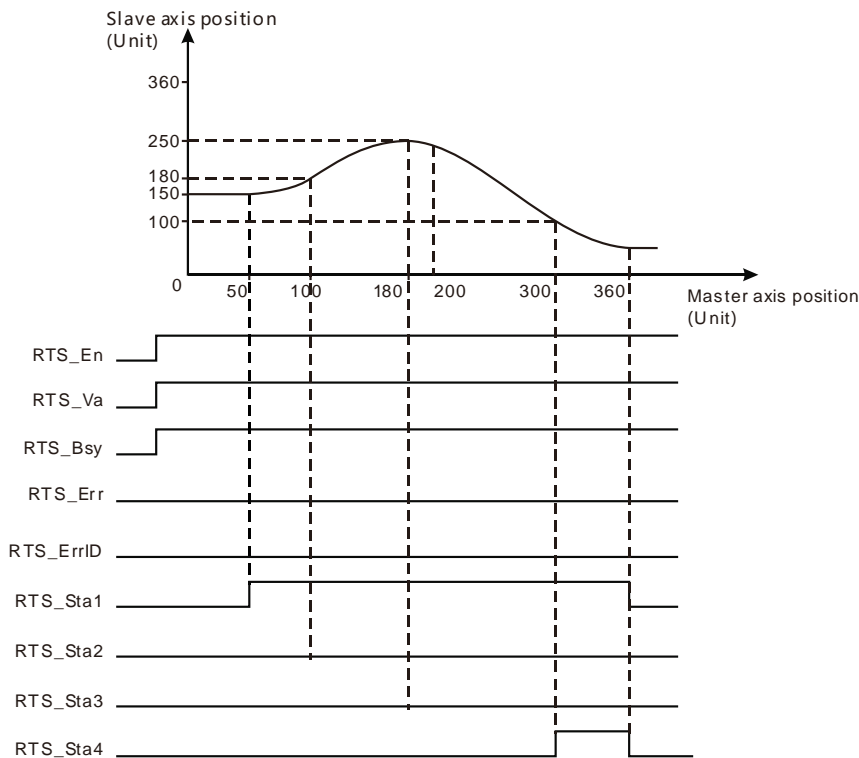

- ❖ Add tappet points in the established cam curve as shown in the above figure. Tappet point 1 is set to PositiveOn when it is passed in the positive direction. Tappet point 2 is set to PositiveDisable when it is passed in the positive direction. Tappet point 3 is set to PositiveOff when it is passed in the positive

- direction. Tappet point 4 is set to PositiveInvert when it is passed in the positive direction.
- ❖ When the axis runs forward and RTS_En changes from FALSE to TRUE, DMC_CamReadTappetStaus is executed. (Because the first tappet point selects PositiveOn,) RTS_Sta1 changes from FALSE to TRUE when the axis passes the first tappet point in the cam curve. (Because the second tappet point selects PositiveDisable,) RTS_Sta2 is FALSE when the second tappet point is passed. (Because the third tappet point selects PositiveOff,) RTS_Sta3 is FALSE when the third tappet point is passed. (Because the forth tappet point selects PositiveInvert,) RTS_Sta4 changes from FALSE to TRUE when the forth tappet point is passed.
 - ❖ RTS_Sta1 and RTS_Sta4 change to FALSE when the master axis passes the final point of the cam curve.

11.4.11 DMC_CamReadTappetValue

FB/FC	Explanation	Applicable model
FB	DMC_CamReadTappetValue reads the parameters of one tappet point.	DVP15MC11T DVP15MC11T-06

DMC_CamReadTappetValue_instance

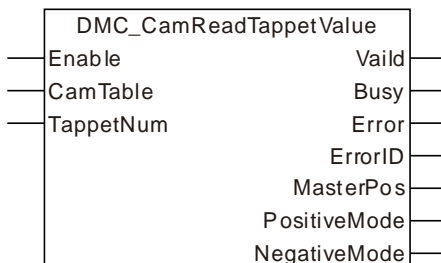

● Input Parameters

Parameter name	Function	Data type	Valid range (Default)	Validation timing
Enable	The instruction is executed when <i>Enable</i> changes from FALSE to TRUE.	BOOL	TRUE or FALSE (FALSE)	When Enable is TRUE.
CamTable	The number of the cam table based on which the cam relationship between the master axis and slave axis is built.	USINT	1~64 (The variable value must be set)	When <i>Enable</i> is TRUE.
TappetNum	The number of the tappet point to read	UINT	1~128 (The variable value must be set)	When Enable is TRUE.

● Output Parameters

Parameter name	Function	Data type	Valid range
Valid	TRUE when the output of the instruction is valid.	BOOL	TRUE / FALSE
Busy	TRUE when the instruction is being executed.	BOOL	TRUE / FALSE
Error	TRUE when there is an error in the execution of the instruction.	BOOL	TRUE / FALSE
ErrorID	Contains the error code when an error occurs. Please refer to section 12.2.	WORD	
MasterPos	Displays the master axis position.	LREAL	
PositiveMode	The status mode selection for the tappet point when the axis passes the tappet point in the positive direction.	PositiveMode_Type	0: PositiveDisable 1: PositiveOn 2: PositiveOff 3: PositiveInvert
NegativeMode	The status mode selection for the tappet point when the axis passes the tappet point in the negative direction.	NegativeMode_Type	0: NegativeDisable 1: NegativeOn 2: NegativeOff 3: NegativeInvert

● Output Update Timing

Name	Timing for changing to TRUE	Timing for changing to FALSE
Valid	◆ When the instruction execution is completed.	◆ When <i>Enable</i> changes to FALSE.
Busy	◆ When <i>Enable</i> is TRUE.	◆ When <i>Done</i> changes to TRUE. ◆ When <i>Error</i> changes to TRUE.
Error	◆ When any of the input parameters is illegal.	◆ When <i>Enable</i> changes from TRUE to FALSE.

● Output Update Timing Chart

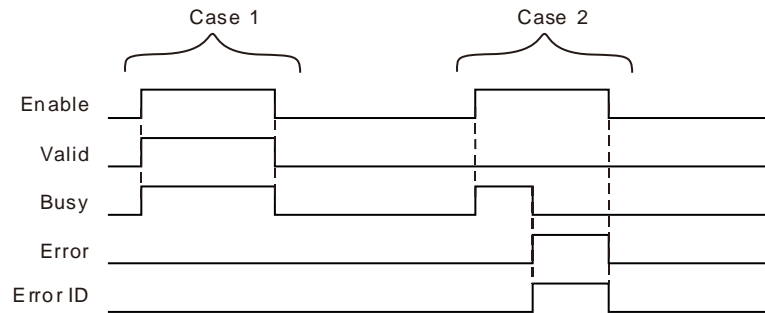

Case 1 : When *Enable* changes from FALSE to TRUE, *Valid* and *Busy* change to TRUE. When *Enable* changes to FALSE, *Valid* and *Busy* change to FALSE.

Case 2 : When an error occurs, *Error* changes to TRUE and *ErrorID* shows corresponding error code. Meanwhile *Busy* changes to FALSE. *Error* changes to FALSE when *Enable* changes from TRUE to FALSE and then the value of *ErrorID* is cleared to 0.

● Functions

The tappet point information includes the master axis position and the modes when the tappet point is passed in the positive direction and in the negative direction. When the axis runs forward, a tappet point can select PositiveDisable, PositiveOn, PositiveOff or PositiveInvert. When the axis runs reversely, a tappet point can select NegativeDisable, NegativeOn, NegativeOff or NegativeInvert. The meanings of modes are listed in the following table.

Mode	Function	Explanation
PositiveDisable	Disabled	When the master axis passes the tappet point in the positive direction, the status of the tappet point which is read has no change.
PositiveOn	ON	When the master axis passes the tappet point in the positive direction, the status of the tappet point which is read is ON.
PositiveOff	OFF	When the master axis passes the tappet point in the positive direction, the status of the tappet point which is read is OFF.
PositiveInvert	Invert	When the master axis passes the tappet point in the positive direction, the status of the tappet point which is read will be OFF if the status of the tappet point is ON before the tappet point is passed in the positive direction. Otherwise, the status of the tappet point which is read will be ON if the status of the tappet point is OFF before the tappet point is passed in the positive direction.
NegativeDisable	Disabled	When the master axis passes the tappet point in the negative direction, the status of the tappet point which is read has no change.
NegativeOn	ON	When the master axis passes the tappet point in the negative direction, the status of the tappet point which is read is ON.
NegativeOff	OFF	When the master axis passes the tappet point in the negative direction, the status of the tappet point which is read is OFF.
NegativeInvert	Invert	When the master axis passes the tappet point in the negative direction, the status of the tappet point which is read will be OFF if the status of the tappet point is ON before the tappet point is passed in the negative direction. Otherwise, the status of the tappet point which is read will be

Mode	Function	Explanation
		ON if the status of the tappet point is OFF before the tappet point is passed in the negative direction.

11

 **Programming Example**

1. **The variable table and program**

Variable name	Data type	Initial value
RTV	DMC_CamReadTappetValue	
RTV_En	BOOL	FALSE
RTV_CT	USINT	1
RTV_TN	UINT	2
RTV_Va	BOOL	
RTV_Bsy	BOOL	
RTV_Err	BOOL	
RTV_ErrID	WORD	
RTV_MP	LREAL	
RTV_PM	PositiveMode_Type	
RTV_NM	NegativeMode_Type	

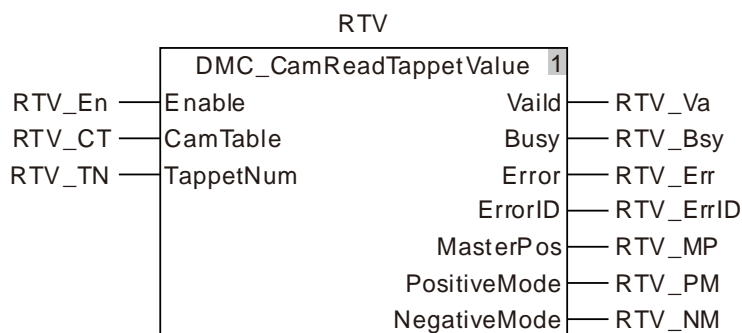

2. **Table of tappet points**

Index	Master axis position	Slave axis position	Passed in the positive direction	Passed in the negative direction
1	108.0	235.0	PositiveOn	NegativeInvert
2	200.0	250.0	PositiveOff	NegativeOff
3	300.0	192.0	PositiveInvert	NegativeOn

❖ When RTV_En changes from FALSE to TRUE, DMC_CamReadTappetValue is executed. When RTV_Va changes to TRUE, the instruction execution is finished and the tappet point information is read as follows.

Index	Master axis position	Passed in the positive direction	Passed in the negative direction
2	200.0	PositiveOff	NegativeOff

11.4.12 DMC_CamWriteTappetValue

FB/FC	Explanation	Applicable model
FB	DMC_CamWriteTappetValue is used for setting the parameters for a tappet point.	DVP15MC11T DVP15MC11T-06

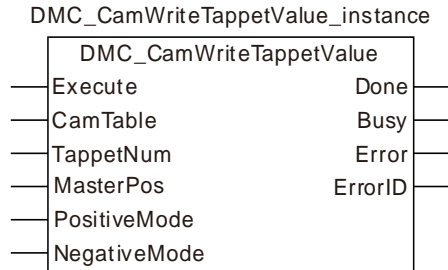

● Input Parameters

Parameter name	Function	Data type	Valid range (Default)	Validation timing
Execute	The instruction is executed when <i>Execute</i> changes from FALSE to TRUE.	BOOL	TRUE or FALSE (FALSE)	-
CamTable	The number of the cam table based on which the cam relationship between the master axis and slave axis is built.	USINT	1~64 (The variable value must be set)	When <i>Execute</i> changes from FALSE to TRUE.
TappetNum	The number of the tappet point	UINT	1~128 (The variable value must be set)	When <i>Execute</i> changes from FALSE to TRUE.
MasterPos	Master position of the tappet point	LREAL	0, positive number	When <i>Execute</i> changes from FALSE to TRUE.
PositiveMode	The mode of the tappet point when the axis runs forward and passes it.	PositiveMode_Type	0 : PositiveDisable 1 : PositiveOn 2 : PositiveOff 3 : PositiveInvert	When <i>Execute</i> changes from FALSE to TRUE.
NegativeMode	The mode of the tappet point when the axis runs backward and passes it.	NegativeMode_Type	0 : NegativeDisable 1 : NegativeOn 2 : NegativeOff 3 : NegativeInvert	When <i>Execute</i> changes from FALSE to TRUE.

● Output Parameters

Parameter name	Function	Data type	Valid range
Done	TRUE when the instruction execution is completed.	BOOL	TRUE / FALSE
Busy	TRUE when the instruction is being executed.	BOOL	TRUE / FALSE
Error	TRUE when there is an error in the execution of the instruction.	BOOL	TRUE / FALSE
ErrorID	Contains the error code when an error occurs. Please refer to section 12.2.	WORD	

● Output Update Timing

Name	Timing for changing to TRUE	Timing for changing to FALSE
Done	◆ When the instruction execution is completed.	◆ When <i>Execute</i> changes to FALSE.
Busy	◆ When <i>Execute</i> is TRUE.	◆ When <i>Done</i> changes to TRUE. ◆ When <i>Error</i> changes to TRUE.
Error	◆ When any of the input parameters is illegal.	◆ When <i>Execute</i> changes from TRUE to FALSE.

● **Output Update Timing Chart**

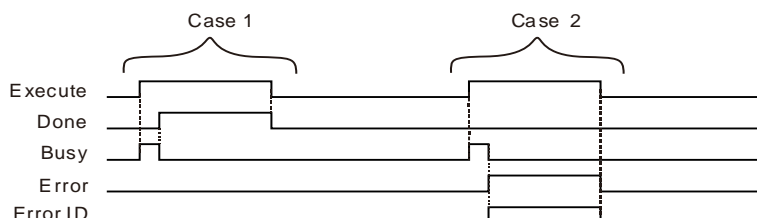

Case 1 : When *Execute* changes from FALSE to TRUE, *Busy* changes to TRUE. When the instruction execution is completed, *Done* changes to TRUE and *Busy* changes to FALSE. When *Execute* changes to FALSE, *Done* changes to FALSE.

Case 2 : When an error occurs, *Error* changes to TRUE and *ErrorID* shows corresponding error code. When *Execute* changes from TRUE to FALSE, *Error* changes to FALSE and the value of *ErrorID* is cleared to 0.

● **Functions**

DMC_CamWriteTappetValue is used for setting the parameters for a tappet point including the master axis position and the status mode of the tappet point when the tappet point is passed in the positive direction and in the negative direction.

Generally, the setting for a tappet point is conducted in the cam built on the software. For a dynamic change of the tappet point setting, use the DMC_CamWriteTappetValue instruction.

After the setting for a tappet point is over, use DMC_CamReadTappetStatus to read the status of the tappet point when the master axis passes the tappet point.

When the axis runs forward, the tappet point can select such a mode as PositiveDisable, PositiveOn, PositiveOff or PositiveInvert. When the axis runs backward, the tappet point can select such a mode as NegativeDisable, NegativeOn, NegativeOff or NegativeInvert.

The meanings of modes are shown in the following table.

Mode	Function	Explanation
PositiveDisable	Disabled	When the master axis passes the tappet point in the positive direction, the status of the tappet point which is read has no change.
PositiveOn	ON	When the master axis passes the tappet point in the positive direction, the status of the tappet point which is read is ON.
PositiveOff	OFF	When the master axis passes the tappet point in the positive direction, the status of the tappet point which is read is OFF.
PositiveInvert	Invert	When the master axis passes the tappet point in the positive direction, the status of the tappet point which is read will be OFF if the status of the tappet point is ON before the tappet point is passed in the positive direction. Otherwise, the status of the tappet point which is read will be ON if the status of the tappet point is OFF before the tappet point is passed in the positive direction.
NegativeDisable	Disabled	When the master axis passes the tappet point in the negative direction, the status of the tappet point which is read has no change.
NegativeOn	ON	When the master axis passes the tappet point in the negative direction, the status of the tappet point which is read is ON.
NegativeOff	OFF	When the master axis passes the tappet point in the negative direction, the status of the tappet point which is read is OFF.
NegativeInvert	Invert	When the master axis passes the tappet point in the negative direction, the status of the tappet point which is read will be OFF if

Mode	Function	Explanation
		the status of the tappet point is ON before the tappet point is passed in the negative direction. Otherwise, the status of the tappet point which is read will be ON if the status of the tappet point is OFF before the tappet point is passed in the negative direction.

- **Precaution**

Please make sure that the cam curve is called for use by one MC_CamIn instruction at most if DMC_CamWriteTappetValue is used to set the parameters for one tappet point in the cam curve.

If the cam curve is called by multiple MC_CamIn instructions, the tappet point to be modified which is used in the programs will be changed when DMC_CamWriteTappetValue is used to change the parameters of one tappet point.



Programming Example

1. The variable table and program

Variable name	Data type	Initial value
WTV	DMC_CamWriteTappetValue	
WTV_Ex	BOOL	FALSE
WTV_CT	USINT	1
WTV_TN	UINT	2
WTV_MP	LREAL	200.0
WTV_PM	LREAL	PositiveOff
WTV_NM	LREAL	NegativeOff
WTV_Done	BOOL	
WTV_Bsy	BOOL	
WTV_Err	BOOL	
WTV_ErrID	WORD	
RTV	DMC_CamReadTappetValue	
RTV_En	BOOL	FALSE
RTV_CT	USINT	1
RTV_TN	UINT	2
RTV_Va	BOOL	
RTV_Bsy	BOOL	
RTV_Err	BOOL	
RTV_ErrID	WORD	
RTV_MP	LREAL	
RTV_PM	PositiveMode_Type	
RTV_NM	NegativeMode_Type	

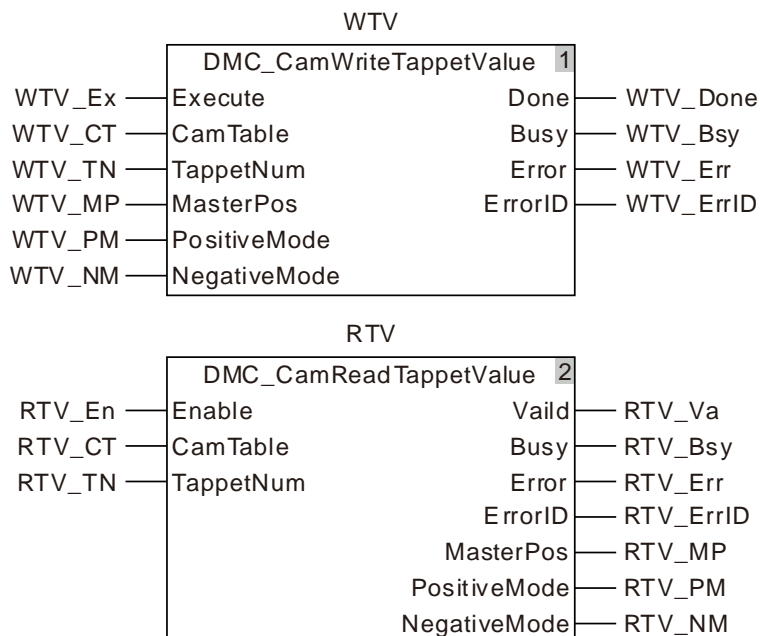

2. Table of tappet points

Index	Master axis position	Slave axis position	Passed in the positive direction	Passed in the negative direction
1	108.0	235.0	ON	Invert
2	200.0	250.0	OFF	OFF
3	300.0	192.0	Invert	ON

- ❖ When WTV_Ex changes from FALSE to TRUE, DMC_CamWriteTappetValue is executed. When WTV_Done changes to TRUE, the execution of the instruction is finished and the information of the second tappet point is written as below.

Index	Master axis position	Passed in the positive direction	Passed in the negative direction
2	250.0	PositiveOff	NegativeOff

- ❖ When RTV_En changes from FALSE to TRUE, DMC_CamReadTappetValue is executed. When RTV_Done changes to TRUE, the execution of the instruction is finished and the information of one tappet point which is read is shown as below.

Index	Master axis position	Passed in the positive direction	Passed in the negative direction
2	250.0	PositiveOff	NegativeOff

11.4.13 DMC_CamAddTappet

FB/FC	Explanation	Applicable model
FB	DMC_CamAddTappet is used for adding a tappet point.	DVP15MC11T DVP15MC11T-06

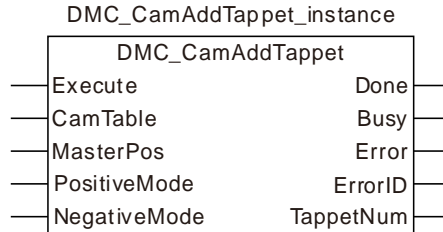

● Input Parameters

Parameter name	Function	Data type	Valid range (Default)	Validation timing
Execute	The instruction is executed when <i>Execute</i> changes from FALSE to TRUE.	BOOL	TRUE or FALSE (FALSE)	-
CamTable	The number of the cam table based on which the cam relationship between the master axis and slave axis is built.	USINT	1~64 (The variable value must be set)	When <i>Execute</i> changes from FALSE to TRUE.
MasterPos	Master axis position of the tappet point	LREAL	0, positive number	When <i>Execute</i> changes from FALSE to TRUE.
PositiveMode	Status mode of the tappet point when the axis runs forward.	PositiveMode_Type	0: PositiveDisable 1: PositiveOn 2: PositiveOff 3: PositiveInvert	When <i>Execute</i> changes from FALSE to TRUE.
NegativeMode	Status mode of the tappet point when the axis runs backward.	NegativeMode_Type	0: NegativeDisable 1: NegativeOn 2: NegativeOff 3: NegativeInvert	When <i>Execute</i> changes from FALSE to TRUE.

● Output Parameters

Parameter name	Function	Data type	Valid range
Done	TRUE when the instruction execution is completed.	BOOL	TRUE / FALSE
Busy	TRUE when the instruction is being executed.	BOOL	TRUE / FALSE
Error	TRUE when there is an error in the execution of the instruction.	BOOL	TRUE / FALSE
ErrorID	Contains the error code when an error occurs. Please refer to section 12.2.	WORD	
TappetNum	Outputs the number of the added tappet point.	UINT	1~128

● Output Update Timing

Name	Timing for changing to TRUE	Timing for changing to FALSE
Done	◆ When the instruction execution is completed.	◆ When <i>Execute</i> changes to FALSE.
Busy	◆ When <i>Execute</i> is TRUE.	◆ When <i>Done</i> changes to TRUE. ◆ When <i>Error</i> changes to TRUE.
Error	◆ When any of the input parameters is illegal.	◆ When <i>Execute</i> changes from TRUE to FALSE.

● Output Update Timing Chart

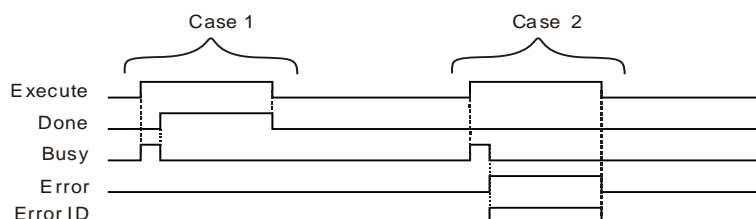

Case 1 : When *Execute* changes from FALSE to TRUE, *Busy* changes to TRUE. When the instruction execution is completed, *Done* changes to TRUE and *Busy* changes to FALSE. When *Execute* changes to FALSE, *Done* changes to FALSE.

Case 2 : When an error occurs, *Error* changes to TRUE and *ErrorID* shows corresponding error code. When *Execute* changes from TRUE to FALSE, *Error* changes to FALSE and the value of *ErrorID* is cleared to 0.

● Functions

DMC_CamAddTappet is used for adding a tappet point by setting the master axis position and the status mode of the tappet point when the tappet point is passed in the positive direction and in negative direction. The number of the added tappet point is accumulated on the basis of the numbers of existing tappet points. For example, if the largest number of tappet points is 3 previously, the largest number of tappet points is 4 after the instruction is executed.

When the axis runs forward, the added tappet point can select such a mode as PositiveDisable, PositiveOn, PositiveOff or PositiveInvert. When the axis runs backward, the added tappet point can select such a mode as NegativeDisable, NegativeOn, NegativeOff or NegativeInvert.

The meanings of modes are shown in the following table.

Mode	Function	Explanation
PositiveDisable	Disabled	When the master axis passes the tappet point in the positive direction, the status of the tappet point which is read has no change.
PositiveOn	ON	When the master axis passes the tappet point in the positive direction, the status of the tappet point which is read is ON.
PositiveOff	OFF	When the master axis passes the tappet point in the positive direction, the status of the tappet point which is read is OFF.
PositiveInvert	Invert	When the master axis passes the tappet point in the positive direction, the status of the tappet point which is read will be OFF if the status of the tappet point is ON before the tappet point is passed in the positive direction. Otherwise, the status of the tappet point which is read will be ON if the status of the tappet point is OFF before the tappet point is passed in the positive direction.
NegativeDisable	Disabled	When the master axis passes the tappet point in the negative direction, the status of the tappet point which is read has no change.
NegativeOn	ON	When the master axis passes the tappet point in the negative direction, the status of the tappet point which is read is ON.
NegativeOff	OFF	When the master axis passes the tappet point in the negative direction, the status of the tappet point which is read is OFF.
NegativeInvert	Invert	When the master axis passes the tappet point in the negative direction,

Mode	Function	Explanation
		the status of the tappet point which is read will be OFF if the status of the tappet point is ON before the tappet point is passed in the negative direction. Otherwise, the status of the tappet point which is read will be ON if the status of the tappet point is OFF before the tappet point is passed in the negative direction.

- **Precaution**

Make sure that the cam curve is called for use by one MC_CamIn instruction at most if DMC_CamAddTappet is used to add one tappet point in the cam curve.

If the cam curve is called by multiple MC_CamIn instructions, the added tappet point can be used in the programs when DMC_CamAddTappet is used to add one tappet point.



Programming Example

1. The variable table and program

Variable name	Data type	Initial value
CAT	DMC_CamAddTappet	
CAT_Ex	BOOL	FALSE
CAT_CT	USINT	1
CAT_MP	LREAL	200.0
CAT_PM	LREAL	PositiveOff
CAT_NM	LREAL	NegativeOff
CAT_Done	BOOL	
CAT_Bsy	BOOL	
CAT_Err	BOOL	
CAT_ErrID	WORD	
CAT_TN	UINT	
RTV	DMC_CamReadTappetValue	
RTV_En	BOOL	FALSE
RTV_CT	USINT	1
RTV_TN	UINT	4
RTV_Va	BOOL	
RTV_Bsy	BOOL	
RTV_Err	BOOL	
RTV_ErrID	WORD	
RTV_MP	LREAL	
RTV_PM	PositiveMode_Type	
RTV_NM	NegativeMode_Type	

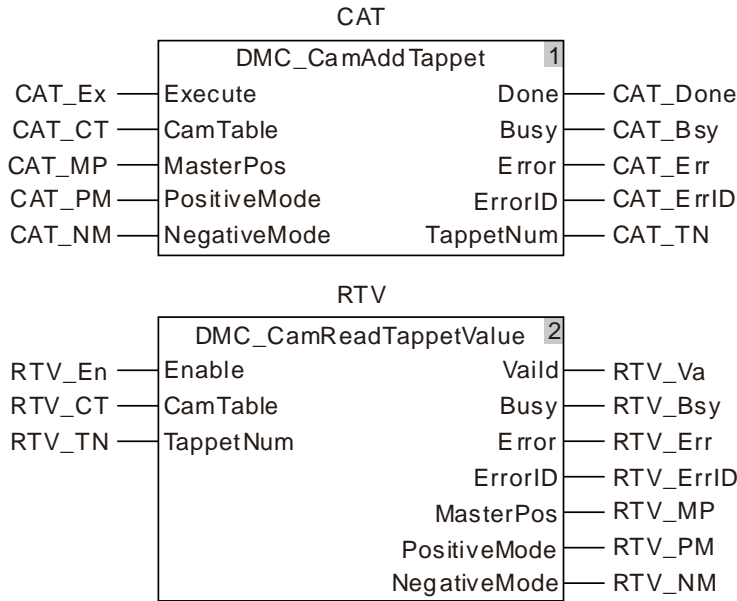

2. Table of tappet points

Index	Master axis position	Slave axis position	Passed in the positive direction	Passed in the negative direction
1	108.0	235.0	ON	Invert
2	200.0	250.0	OFF	OFF
3	300.0	192.0	Invert	ON

There are three tappet points which have been added in the established cam curve. Now add the forth tappet point using DMC_CamAddTappet instruction.

- ❖ When CAT_Ex changes from FALSE to TRUE, DMC_CamAddTappet is executed. When CAT_Done changes to TRUE, the instruction execution is finished and the information of the forth tappet point which is added is shown as below.

Index	Master axis position	Passed in the positive direction	Passed in the negative direction
4	250.0	PositiveOff	NegativeOff

- ❖ When RTV_En changes from FALSE to TRUE, DMC_CamReadTappetValue is executed. When RTV_Done changes to TRUE, the instruction execution is completed and the information of the tappet point which is read is shown as below.

Index	Master axis position	Passed in the positive direction	Passed in the negative direction
4	250.0	PositiveOff	NegativeOff

11.4.14 DMC_CamDeleteTappet

FB/FC	Explanation	Applicable model
FB	DMC_CamDeleteTappet is used for deleting a tappet point.	DVP15MC11T DVP15MC11T-06

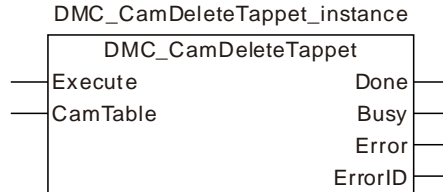

● Input Parameters

Parameter name	Function	Data type	Valid range (Default)	Validation timing
Execute	The instruction is executed when <i>Execute</i> changes from FALSE to TRUE.	BOOL	TRUE or FALSE (FALSE)	-
CamTable	The number of the cam table based on which the cam relationship between the master axis and slave axis is built.	USINT	1~64 (The variable value must be set)	When <i>Execute</i> changes from FALSE to TRUE.

● Output Parameters

Parameter name	Function	Data type	Valid range
Done	TRUE when the instruction execution is completed.	BOOL	TRUE / FALSE
Busy	TRUE when the instruction is being executed.	BOOL	TRUE / FALSE
Error	TRUE when there is an error in the execution of the instruction.	BOOL	TRUE / FALSE
ErrorID	Contains the error code when an error occurs. Please refer to section 12.2.	WORD	

● Output Update Timing

Name	Timing for changing to TRUE	Timing for changing to FALSE
Done	◆ When the instruction execution is completed.	◆ When <i>Execute</i> changes to FALSE.
Busy	◆ When <i>Execute</i> is TRUE.	◆ When <i>Done</i> changes to TRUE. ◆ When <i>Error</i> changes to TRUE.
Error	◆ When any of the input parameters is illegal.	◆ When <i>Execute</i> changes from TRUE to FALSE.

● **Output Update Timing Chart**

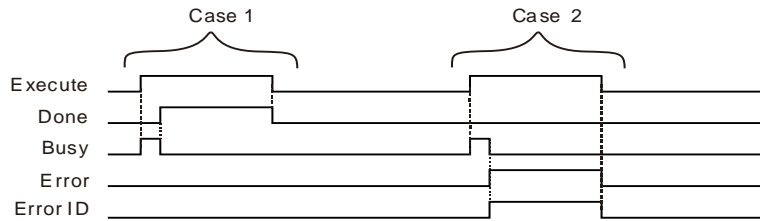

Case 1 : When *Execute* changes from FALSE to TRUE, *Busy* changes to TRUE. When the instruction execution is completed, *Done* changes to TRUE and *Busy* changes to FALSE. When *Execute* changes to FALSE, *Done* changes to FALSE.

Case 2 : When an error occurs, *Error* changes to TRUE and *ErrorID* shows corresponding error code. When *Execute* changes from TRUE to FALSE, *Error* changes to FALSE and the value of *ErrorID* is cleared to 0.

● **Functions**

DMC_CamDeleteTappet is used for deleting a tappet point which is the tappet point of the largest number. Whenever the instruction is executed one time, one tappet point of the largest number will be deleted.

● **Precaution**

Make sure that the cam curve is called for use by one MC_CamIn instruction at most if DMC_CamDeleteTappet is used to delete one tappet point in the cam curve. If the cam curve is called by multiple MC_CamIn instructions, the tappet point to be deleted which is used in the programs will be deleted when DMC_CamDeleteTappet is used to delete one tappet point.



Programming Example

1. The variable table and program

Variable name	Data type	Initial value
CDT	DMC_CamDeletTappet	
CDT_Ex	BOOL	FALSE
CDT_CT	USINT	1
CDT_Done	BOOL	
CDT_Bsy	BOOL	
CDT_Err	BOOL	
CDT_ErrID	WORD	
RTV	DMC_CamReadTappetValue	
RTV_En	BOOL	FALSE
RTV_CT	USINT	1
RTV_TN	UINT	3
RTV_Va	BOOL	
RTV_Bsy	BOOL	
RTV_Err	BOOL	
RTV_ErrID	WORD	
RTV_MP	LREAL	
RTV_PM	PositiveMode_Type	
RTV_NM	NegativeMode_Type	

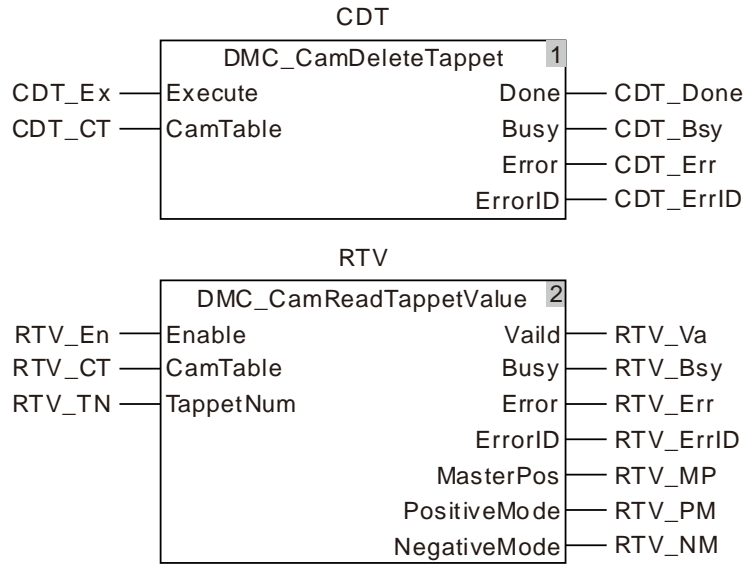

2. Table of tappet points

Index	Master axis position	Slave axis position	Passed in the positive direction	Passed in the negative direction
1	108.0	235.0	PositiveOn	NegativeInvert
2	200.0	250.0	PositiveOff	NegativeOff
3	300.0	192.0	PositiveInvert	NegativeOn

- ❖ When CDT_Ex changes from FALSE to TRUE, DMC_CamDeletTappet is executed. When CDT_Done changes to TRUE, the execution of the instruction is finished and the last tappet point is deleted.
- ❖ When RTV_En changes from FALSE to TRUE, DMC_CamReadTappetValue is executed. Since the third tappet point does not exist, the instruction alerts the error code 16#5505 (indicating no such a tappet point exists).

11.5 Application Instructions

11.5.1 Rotary Cut Technology

Rotary cut is the technology to cut the material in transmission vertically. The knife conducts cutting on the cut surface periodically with the rotation of the rotary cut axis.

11

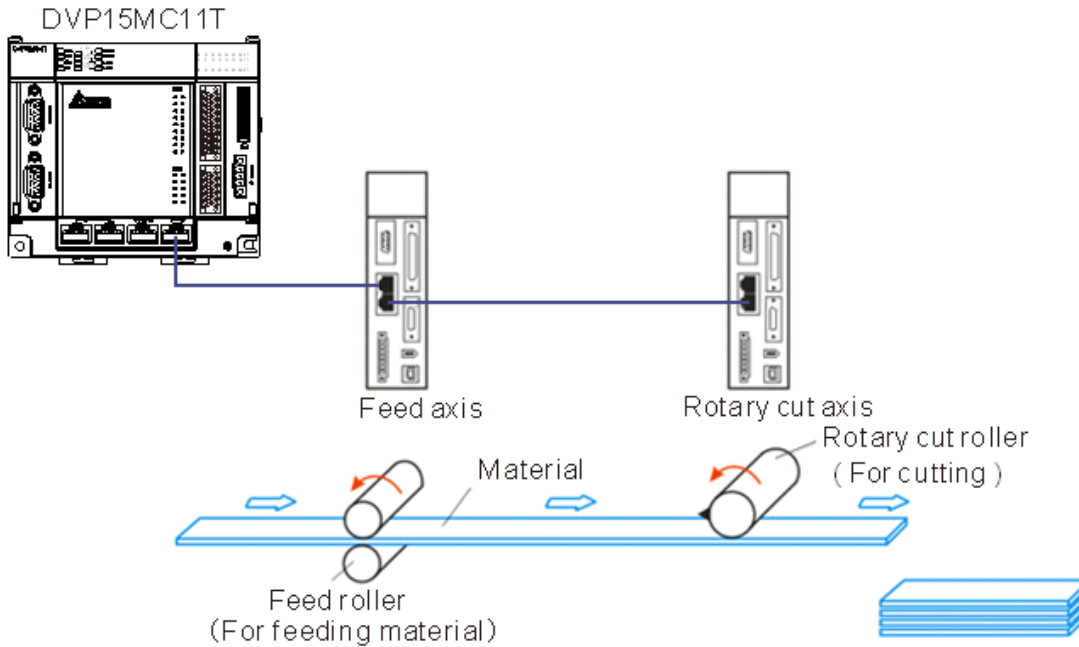

Note:

The feed axis is to control the feed roller; the rotary cut axis is to control rotary cut roller with the knife mounted on the rotary cut roller. The rotary cut function is usually used for cutting of the thin material or the material of medium thinness and can be applied in packaging machine, cutting machine, punching machine, printing machine etc.

11.5.2 Rotary Cut Parameters

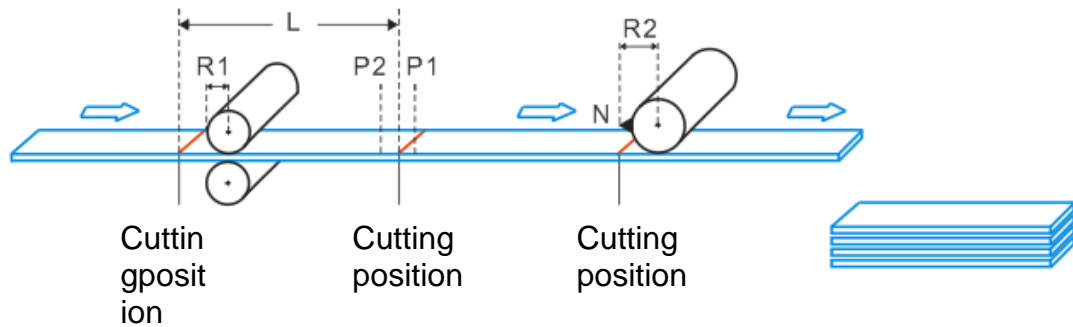

Parameter in the figure	Explanation	Corresponding parameter name of the instruction
L	The cutting length of the processed material	APF_RotaryCut_Init.CutLength
R1	The radius of the feed axis, i.e. the radius length of the feed roller.	APF_RotaryCut_Init.FeedRadius
R2	The radius of the rotary axis, i.e. the distance from the center of the rotary roller to the tool bit.	APF_RotaryCut_Init.RotaryRadius
N	The number of knives of the rotary roller. The number of knives is 1 in the figure above.	APF_RotaryCut_Init.KnifeNum
P1	The starting position of the synchronous area.	APF_RotaryCut_Init.SyncStartPos
P2	The end position of the synchronous area.	APF_RotaryCut_Init.SyncStopPos

11.5.3 Control Feature of Rotary Cut Function

Rotary cut function is a type of special electronic cam function. The figure of cam curve is shown below for continuous cutting.

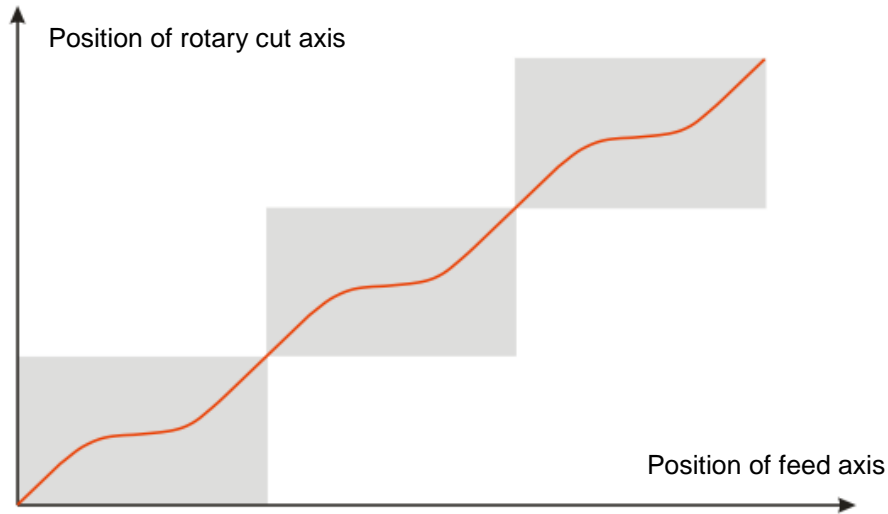

- **Features**

1. Users can set the cutting length freely according to the technological requirement and the cutting length could be less or more than the circumference of the cutter.
2. In the SYNC area, the rotary cut axis and feed axis move at a certain speed rate. (Their velocities are usually equal.) And the cutting of material is conducted in the SYN area.
3. The motion controller supports the rotary roller with multiple knives.
4. The feed axis is able to make the constant motion, acceleration, deceleration and irregular motion because the rotary cut axis moves according to the phase of the feed axis after the rotary cut function is enabled.
5. When rotary cut relation is broken off, the knife stops at the zero point of the system, i.e. the entry position for rotary cutting.

11.5.4 Introduction to Cam Curve with Rotary Cut Function

The cam curve with the rotary cut function could be divided into the SYNC area and adjustment area.

SYNC area: Feed axis and rotary-cut axis make the motion at a fixed speed ratio (Linear speed of the knife is usually equal to that of the cut surface), and material cutting takes place in SYNC area.

Adjustment area: Due to different cutting length, positioning need be adjusted accordingly. Adjustment area can be in the following three situations based on various cutting length.

1. Short material cutting

When cutting length is less than the knife roller circumference, the rotary-cut curve for any cycle is shown below.

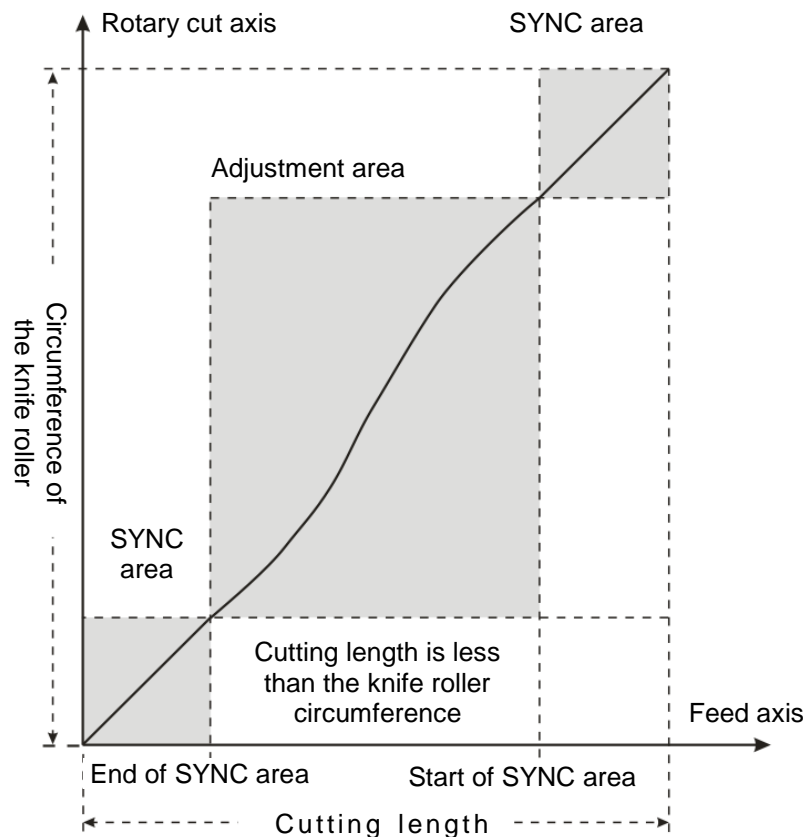

For the cutting of short material, rotary cut axis must accelerate first in the adjustment area, and then decelerate to the synchronous speed.

2. Equal-length cutting

When the cutting length is equal to the knife roller circumference, the rotary-cut curve for any cycle is shown below.

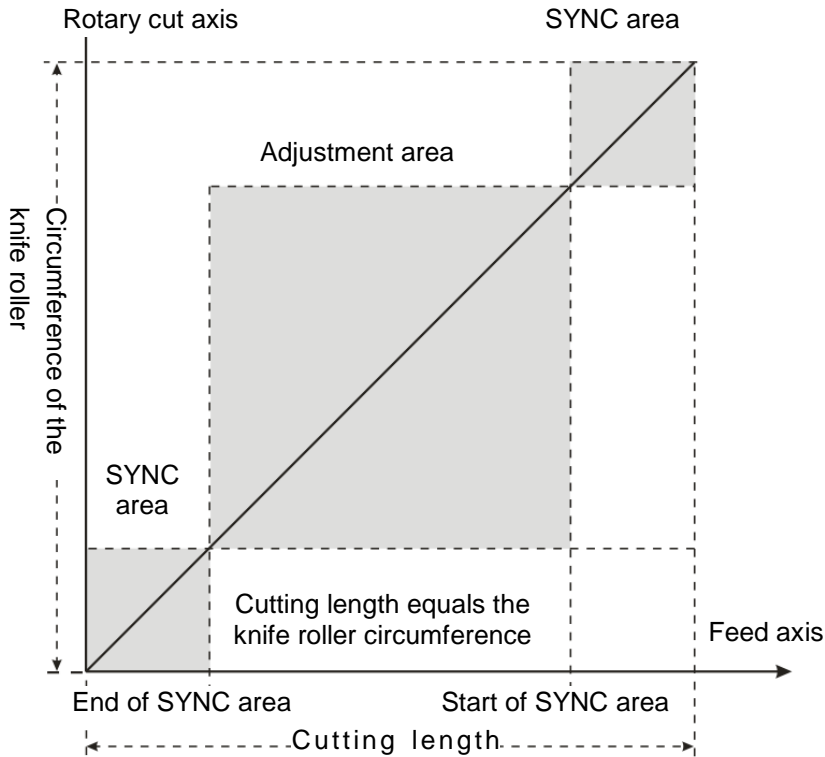

In this situation, the feed axis and rotary cut axis in SYNC area and non-SYNC area keep synchronous in speed. The rotary cut axis does not need to make any adjustment.

3. Long material cutting

When the cutting length is greater than the knife roller circumference, the rotary-cut curve for any cycle is shown below.

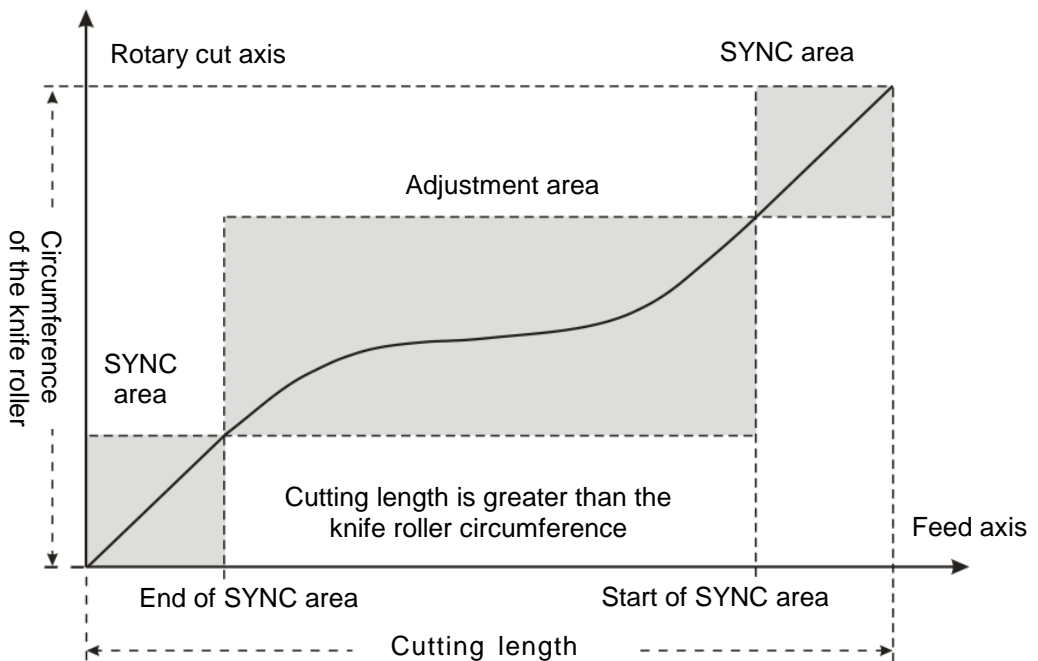

In this situation, the rotary cut axis should decelerate first in the adjustment area and then accelerate to the synchronous speed. If the cutting length is far greater than rotary cut roller circumference, the roller

may decelerate to 0 and stay still for a while; and then accelerate up to the synchronous speed. The greater the cutting length is, the longer the roller stays.

Additionally, when rotary cut function is started or broken off, the cam curves used are different.

4. The entry curve

It is the rotary cut curve when rotary cut function is started.

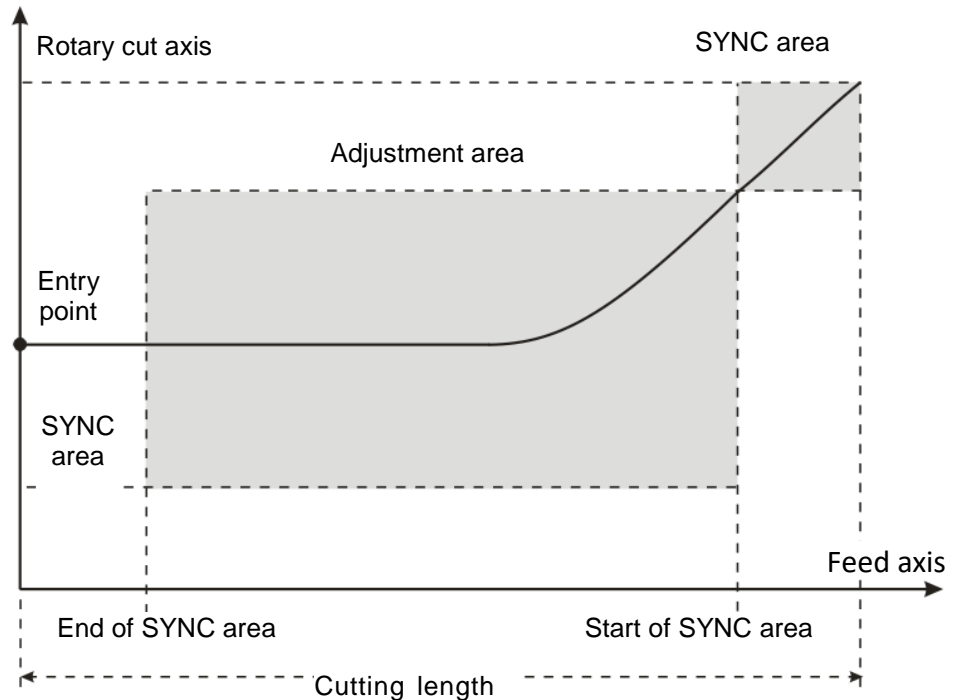

The curve is the rotary cut function entry curve. When the rotary cut function is started up, the rotary cut axis will follow the feed axis to rotate according to the curve. The entry position is based on the rotary cut axis. For the single knife, the cutting position is directly below the rotary cut roller if the entry position is over the rotary cut roller in the following figure. Before the rotary cut function is started up, the knife must be turned to the upper of the rotary roller. Otherwise, the cutting may happen in the adjustment area.

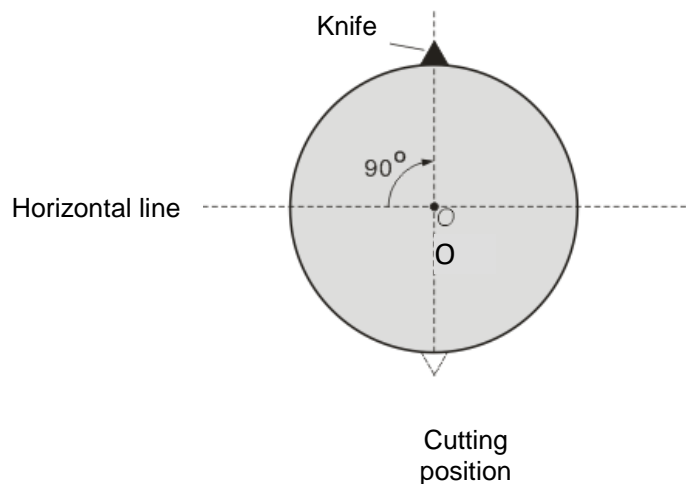

When the rotary roller is mounted with multiple knives, the distances between knives should be the same and the cutting position is at the center of the distance between knives. See the two-knife figure below.

11

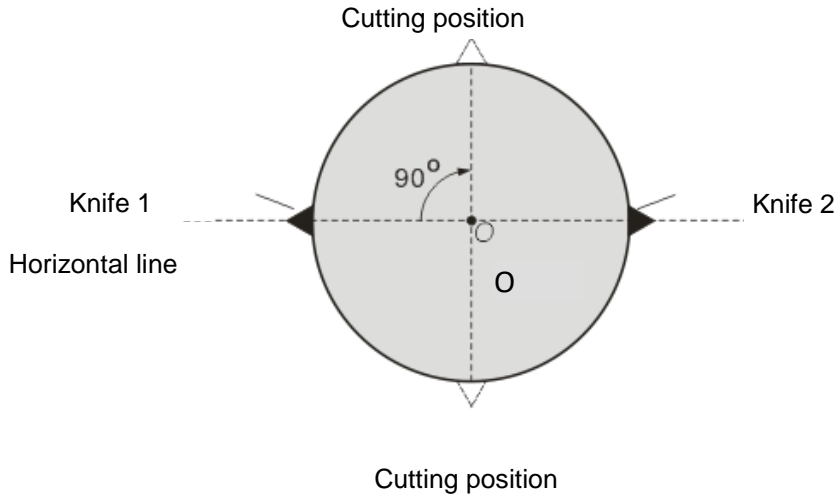

5. The end curve

It is the rotary-cut curve when the rotary cut function is broken away.

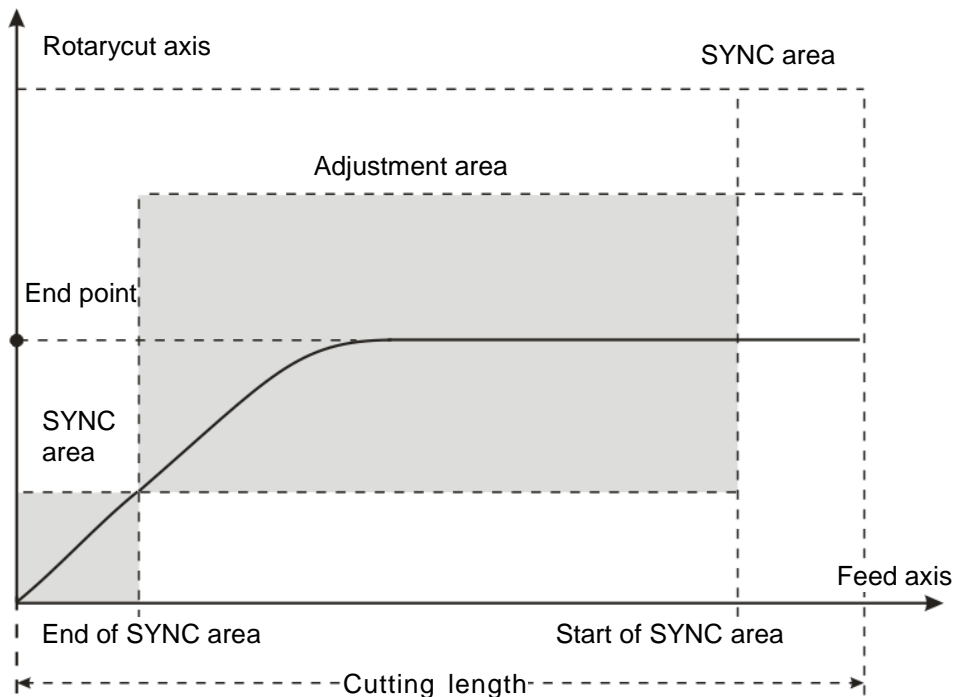

After the instruction “APF_RotaryCut_Out” is started up, the system will use the curve to make the rotary cut axis break away from the rotary cut state. Eventually, the knife stops at the end position as shown in the figure above.

The end position is based on the rotary cut axis. For the single knife, the end position is the entry position and it is also right above the rotary cut roller.

11.5.5 Rotary-cut Instructions

11.5.5.1 APF_RotaryCut_Init

FB/FC	Explanation	Applicable model
FB	APF_RotaryCut_Init is used for initializing the radius of the rotary-cut axis and feed axis, the cutting length, synchronous area and etc.	DVP15MC11T DVP15MC11T-06

APF_RotaryCut_Init_instance

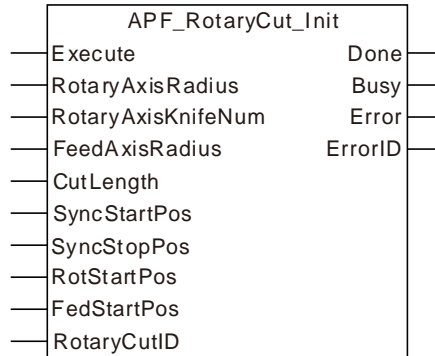

● Input Parameters

Parameter name	Function	Data type	Valid range (Default)	Validation timing
Execute	The instruction is executed when Execute changes from FALSE to TRUE.	BOOL	TRUE or FALSE (FALSE)	
RotaryAxisRadius	The radius of the rotary cut axis, i.e. the distance from the center of the rotary cut roller to the knife.	LREAL	Positive number (The variable value must be set)	When <i>Execute</i> changes from FALSE to TRUE
RotaryAxisKnifeNum	The number of knives of the rotary cut axis, i.e. the number of knives mounted on the rotary cut roller	USINT	Positive number (The variable value must be set)	When Execute changes from FALSE to TRUE
FeedAxisRadius	The radius of the feed axis; i.e. the radius length of the feed roller	LREAL	Positive number (The variable value must be set)	When Execute changes from FALSE to TRUE
CutLength	The cutting length of material	LREAL	Positive number (The variable value must be set)	When Execute changes from FALSE to TRUE
SyncStartPos	The start position of the sync area, i.e. the corresponding feed axis position when the sync area starts.	LREAL	Positive number (The variable value must be set)	When Execute changes from FALSE to TRUE
SyncStopPos	The end position of the sync area, i.e. the corresponding feed axis position when the sync area ends.	LREAL	Positive number (The variable value must be set)	When Execute changes from FALSE to TRUE

Parameter name	Function	Data type	Valid range (Default)	Validation timing
RotStartPos	Reserved	-	-	-
FedStartPos	Reserved	-	-	-
RotaryCutID	The number for a group of rotary cut instructions; a group of rotary cut instructions use the same number. Setting range: 1~8.	USINT	1~8 (The variable value must be set)	When <i>Execute</i> changes from FALSE to TRUE

Notes:

1. The value of "SyncStartPos" in SYNC area is always greater than that of "SyncStopPos" in SYNC area. As shown in the figure below, the cutting length is 320; "SyncStartPos" is 310 and "SyncStopPos" is 10.

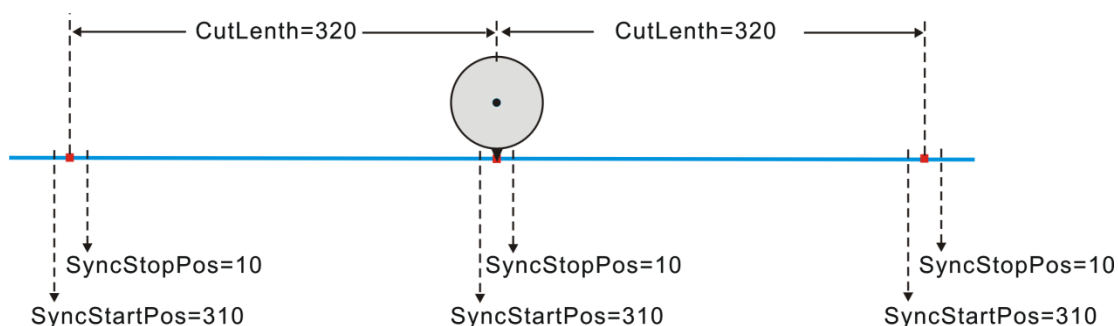

2. The limit for SYNC area is that it must not be greater than the half of cutting length. In above figure, SYNC area is 20, and the half of the cutting length is 160.
3. The length parameters in the function are RotaryAxisRadius, FeedAxisRadius, CutLenth, SyncStartPos, and SyncStopPos with the same unit. For example, if the unit for one of the parameters is CM (centimeter), the units for other parameters must be CM as well.

● **Output Parameters**

Parameter name	Function	Data type	Valid range
Done	TRUE when the instruction is completed.	BOOL	TRUE / FALSE
Busy	TRUE when the instruction is being executed.	BOOL	TRUE / FALSE
Error	TRUE when there is an error.	BOOL	TRUE / FALSE
ErrorID	Contains error codes when an error occurs. Please refer to section 12.2 for the corresponding error code.	WORD	

● **Output Update Timing**

Name	Timing for changing to TRUE	Timing for changing to FALSE
Done	◆ When initializing is completed.	◆ When <i>Execute</i> changes from TRUE to FALSE after the instruction execution is completed. ◆ <i>Done</i> changes to TRUE when the instruction execution is completed after <i>Execute</i> changes from TRUE to FALSE during the instruction execution. One cycle later, <i>Done</i> changes to FALSE.
Busy	◆ When <i>Execute</i> changes to TRUE.	◆ When <i>Done</i> changes to TRUE. ◆ When <i>Error</i> changes to TRUE.

Name	Timing for changing to TRUE	Timing for changing to FALSE
Error	◆ When an error occurs in the instruction execution or the input parameters for the instruction are illegal.	◆ When <i>Execute</i> changes from TRUE to FALSE.

- **Function**

Before the rotary-cut relationship is established, the instruction is used for initializing the radius of the rotary-cut axis and feed axis, cutting length, SYNC area and other parameters. After the instruction execution succeeds, relevant parameters will be downloaded so as to call for use in the established rotary-cut relationship.

After the rotary-cut relationship is established, the instruction can be used to modify the rotary-cut parameters. After the instruction execution is completed, the new parameters will be taken into effect in the next cycle.

11.5.5.2 APF_RotaryCut_In

FB/FC	Explanation	Applicable model
FB	APF_RotaryCut_In is used for establishing the rotary-cut relationship and specifying the axis No. of the rotary-cut axis and feed axis according to the application requirement.	DVP15MC11T DVP15MC11T-06

APF_RotaryCut_In_instance

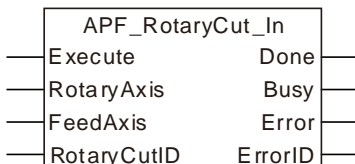

● Input Parameters

Parameter name	Function	Data type	Valid range (Default)	Validation timing
Execute	The instruction is executed when <i>Execute</i> changes from FALSE to TRUE.	BOOL	TRUE or FALSE (FALSE)	
RotaryAxis	The axis No. of the rotary-cut axis	USINT	Refer to Functions of Section 2.2. (The variable value must be set)	When <i>Execute</i> changes from FALSE to TRUE
FeedAxis	The axis No. of the feed axis.	USINT	Refer to Functions of Section 2.2. (The variable value must be set)	When <i>Execute</i> changes from FALSE to TRUE
RotaryCutID	The number for a group of rotary cut instructions; a group of rotary cut instructions use the same number. Setting range: 1~8.	USINT	1~8 (The variable value must be set)	When <i>Execute</i> changes from FALSE to TRUE

● Output Parameters

Parameter name	Function	Data type	Valid range
Done	TRUE when the instruction is completed.	BOOL	TRUE / FALSE
Busy	TRUE when the instruction is being executed.	BOOL	TRUE / FALSE
Error	TRUE when there is an error.	BOOL	TRUE / FALSE
ErrorID	Contains error codes when an error occurs. Please refer to section 12.2 for the corresponding error code.	WORD	

- **Output Update Timing**

Name	Timing for changing to TRUE	Timing for changing to FALSE
Done	<ul style="list-style-type: none"> ◆ When the coupling between the rotary-cut axis and feed axis is completed. 	<ul style="list-style-type: none"> ◆ When <i>Execute</i> changes from TRUE to FALSE after the instruction execution is completed. ◆ <i>Done</i> changes to TRUE when the instruction execution is completed after <i>Execute</i> changes from TRUE to FALSE during the instruction execution. One cycle later, <i>Done</i> changes to FALSE.
Busy	<ul style="list-style-type: none"> ◆ When <i>Execute</i> changes to TRUE. 	<ul style="list-style-type: none"> ◆ When <i>Done</i> changes to TRUE. ◆ When <i>Error</i> changes to TRUE.
Error	<ul style="list-style-type: none"> ◆ When an error occurs in the instruction execution or the input parameters for the instruction are illegal. 	<ul style="list-style-type: none"> ◆ When <i>Execute</i> changes from TRUE to FALSE.

- **Function**

APF_RotaryCut_In is used for building a rotary cut relationship and specifying the axis No. of the rotary-cut axis and feed axis according to the application requirement. The rotary cut axis will follow the feed axis for motion based on the rotary-cut curve after the instruction execution succeeds.

11.5.5.3 APF_RotaryCut_Out

FB/FC	Explanation	Applicable model
FB	APF_RotaryCut_Out is used for disconnecting the already established rotary-cut relationship between the rotary-cut axis and feed axis.	DVP15MC11T DVP15MC11T-06

11

APF_RotaryCut_Out_instance

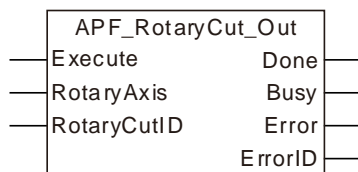

● Input Parameters

Parameter name	Function	Data type	Valid range (Default)	Validation timing
Execute	The instruction is executed when <i>Execute</i> changes from FALSE to TRUE.	BOOL	TRUE or FALSE (FALSE)	
RotaryAxis	The axis number of the rotary axis	USINT	Refer to Functions of Section 2.2. (The variable value must be set)	When <i>Execute</i> changes from FALSE to TRUE
RotaryCutID	The number for a group of rotary cut instructions; a group of rotary cut instructions use the same number. Setting range: 1~8.	USINT	1~8 (The variable value must be set)	When <i>Execute</i> changes from FALSE to TRUE

● Output Parameters

Parameter name	Function	Data type	Valid range
Done	TRUE when the instruction is completed.	BOOL	TRUE / FALSE
Busy	TRUE when the instruction is being executed.	BOOL	TRUE / FALSE
Error	TRUE when there is an error.	BOOL	TRUE / FALSE
ErrorID	Contains error codes when an error occurs. Please refer to section 12.2 for the corresponding error code.	WORD	

Notes:

1. Control Sequence Chart of Rotary Cut Function

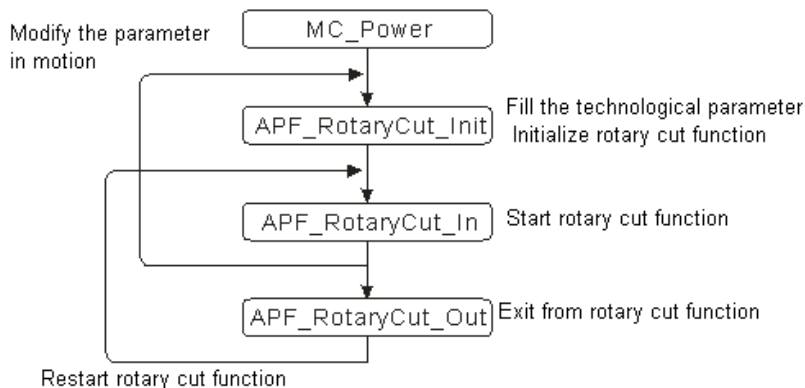

2. When the rotary cut function is performed, the rotary cut axis can only execute APF_RotaryCut_Out and MC_Stop instruction and other instructions are invalid.

- **Output Update Timing**

Name	Timing for changing to TRUE	Timing for changing to FALSE
Done	<ul style="list-style-type: none"> ◆ When rotary-cut relationship disconnecting is completed. 	<ul style="list-style-type: none"> ◆ When <i>Execute</i> changes from TRUE to FALSE after the instruction execution is completed. ◆ <i>Done</i> changes to TRUE when the instruction execution is completed after <i>Execute</i> changes from TRUE to FALSE during the instruction execution. One cycle later, <i>Done</i> changes to FALSE.
Busy	<ul style="list-style-type: none"> ◆ When <i>Execute</i> changes to TRUE 	<ul style="list-style-type: none"> ◆ When <i>Done</i> changes to TRUE. ◆ When <i>Error</i> changes to TRUE.
Error	<ul style="list-style-type: none"> ◆ When an error occurs in the instruction execution or the input parameters for the instruction are illegal. 	<ul style="list-style-type: none"> ◆ When <i>Execute</i> changes from TRUE to FALSE

- **Function**

APF_RotaryCut_Out is used for disconnecting the already established rotary-cut relationship between the rotary-cut axis and feed axis. After the rotary-cut relationship is disconnected, the knife of the rotary-cut axis will stop at the entry position and will not follow the feed axis for motion any more. The instruction has no impact on the motion of the feed axis.

11.5.6 Application Example of Rotary Cut Instructions

The section explains the setting of rotary cut parameters, establishment and disconnection of rotary cut relationship. The following is the programming example.

11

See the key parameters in the example as shown in the table below

Parameter name	Current value
RotaryAxis	2
FeedAxis	1
RotaryAxisRadius	10 (Unit: units)
RotaryAxisKnifeNum	1
FeedAxisRadius	20 (Unit: units)
CutLenth	30 (Unit: units)
SyncStartPos	19 (Unit: units)
SyncStopPos	1 (Unit: unit)



Programming Example

- As Pwr1_En is TRUE, the servo of node address 1 turns "Servo On"; as Pwr2_En is TRUE, the servo of node address 2 turns "Servo On".

The variable table and program

Variable name	Data type	Initial value
Pwr1	MC_Power	
Axis1	USINT	1
Pwr1_En	BOOL	TRUE
Pwr1_BM	MC_Buffer_Mode	0
Pwr1_Sta	BOOL	TRUE
Pwr1_Bsy	BOOL	
Pwr1_Act	BOOL	
Pwr1_Err	BOOL	
Pwr1_ErrID	WORD	
Pwr2	MC_Power	
Axis2	USINT	1
Pwr2_En	BOOL	TRUE
Pwr2_BM	MC_Buffer_Mode	0
Pwr2_Sta	BOOL	TRUE
Pwr2_Bsy	BOOL	
Pwr2_Act	BOOL	
Pwr2_Err	BOOL	
Pwr2_ErrID	WORD	

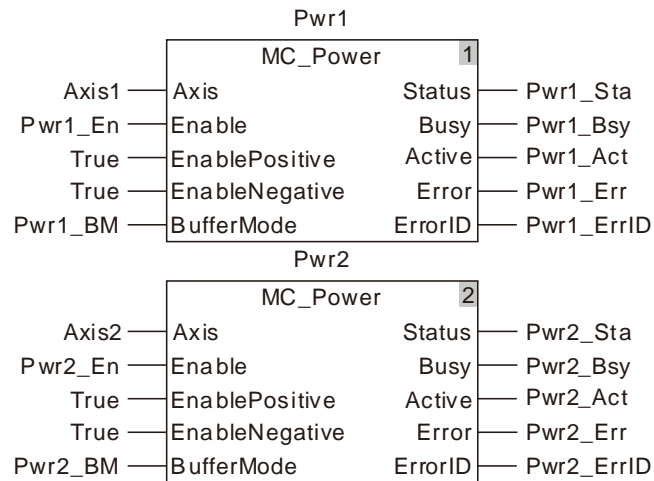

2. Set the rotary cut technology parameters. The radius of the rotary-cut axis is 10, knife quantity of the rotary-cut axis is 1, radius of the feed axis is 20 and cutting length of the feed axis is 30. The start position of SYNC area is 19, end position of SYNC area is 1, and the rotary cut group number is 1. When RotyCut_Init_Ex is TRUE, rotary cut technology parameters will be initialized.

The variable table and program

Variable name	Data type	Initial value
RotyCut_Init	APF_RotaryCut_Init	
RotyCut_Init_Ex	BOOL	TRUE
RotyCut_Init_Done	BOOL	TRUE
RotyCut_Init_Bsy	BOOL	
RotyCut_Init_Err	BOOL	
RotyCut_Init_ErrID	WORD	

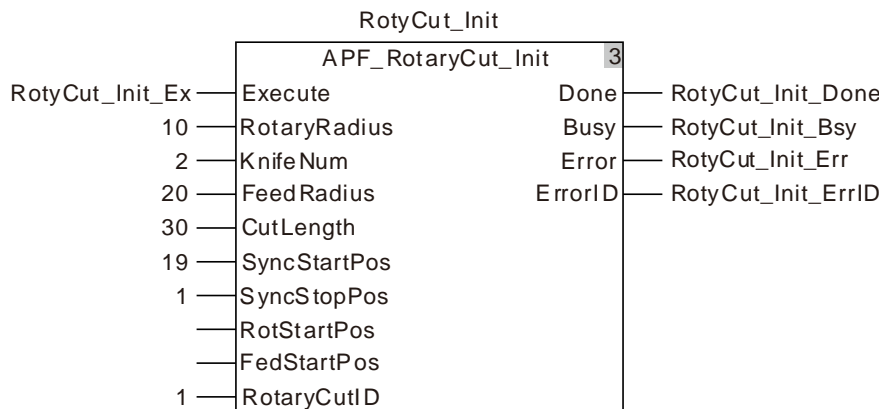

- When RotyCut_In_Ex is TRUE, the rotary-cut relationship starts being established. When RotyCut_In_Done is TRUE, it indicates the rotary-cut relationship between the rotary-cut axis and feed axis is made successfully. Servo 1 is the feed axis and servo 2 is the rotary-cut axis.

11

The variable table and program

Variable name	Data type	Initial value
RotyCut_In	APF_RotyCut_In	
RotyCut_In_Ex	BOOL	TRUE
RotyCut_In_Done	BOOL	TRUE
RotyCut_In_Bsy	BOOL	
RotyCut_In_Err	BOOL	
RotyCut_In_ErrID	WORD	

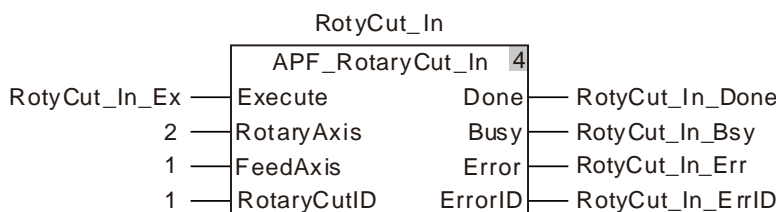

- When Vel_Ex is TRUE, the feed axis starts to execute the velocity instruction. At the moment, the rotary-cut axis executes the rotary cut action based on the phase of the feed axis.

The variable table and program

Variable name	Data type	Initial value
Vel	MC_MoveVelocity	
Axis1	USINT	1
Vel_Ex	BOOL	TRUE
Vel_Dir	MC_DIRECTION	1
Vel_BM	MC_Buffer_Mode	0
Vel_Invel	BOOL	
Vel_Bsy	BOOL	
Vel_Act	BOOL	
Vel_Abt	BOOL	
Vel_Err	BOOL	
Vel_ErrID	WORD	

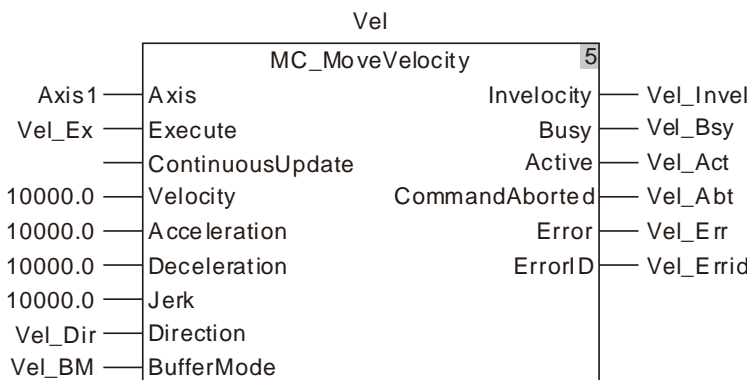

5. When RotyCut_Out_Ex is TRUE, the rotary-cut axis starts to break away from the feed axis. When RotyCut_Out_Done is TRUE, it indicates that the rotary-cut axis breaks away successfully. After the rotary-cut axis breaks away from the feed axis, it will return to the entry point and the motion of the feed axis will not impact the rotary-cut axis any more.

The variable table and program

Variable name	Data type	Initial value
RotyCut_Out	APF_RotyCut_Out	
RotyCut_Out_Ex	BOOL	TRUE
RotyCut_Out_Done	BOOL	TRUE
RotyCut_Out_Bsy	BOOL	
RotyCut_Out_Err	BOOL	
RotyCut_Out_ErrID	WORD	

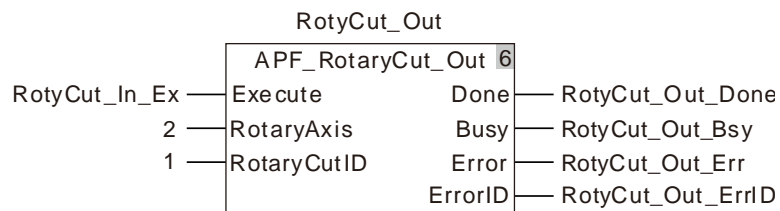

11.6 G Code Instructions

11.6.1 CNC Introduction

As a multi-axis motion controller, the motion controller supports the standard CNC function and can execute G codes statically to achieve the simple numerical control of machine tools and robot control. Beyond that, it could also be applied to the occasions where G codes are used for positioning and path planning.

CANopen Builder software provides CNC G code editing function; user could edit G codes in the CNC editor or import the G codes converted by other design software into this editor. When G codes are input in the code list, the three-dimension chart of G codes is output in the preview window.

All G codes will be downloaded to the controller during the program download.

G codes need be called in the motion control program after being edited. Using DMC_CartesianCoordinate instruction, the servo axis can be controlled for position interpolation.

11.6.2 G Code Input Format

The G code formats that the motion controller supports are listed in the following table.

G code	Function	Number of axes supported	Format
G0	Quick Positioning	8	Format 1: G0 X_ Y_ Z_ A_ B_ C_ P_ Q_
G1	Linear interpolation	8	Format 1: G1 X_ Y_ Z_ A_ B_ C_ P_ Q_ E_ F_
G2	Clockwise circular arc /helical interpolation	8	Format 1: G2 X_ Y_ Z_ A_ B_ C_ P_ Q_ I_ J_ (I_ K_ / J_ K_)T_ E_ F_ Format 2: G2 X_ Y_ Z_ A_ B_ C_ P_ Q_ R_ T_ E_ F_
G3	Anticlockwise circular arc /helical interpolation	8	Format 1: G3 X_ Y_ Z_ A_ B_ C_ P_ Q_ I_ J_ (I_ K_ / J_ K_)T_ E_ F_ Format 2: G3 X_ Y_ Z_ A_ B_ C_ P_ Q_ R_ T_ E_ F_
G4	Delay instruction	--	Format 1: G4 K_
G17	XY plane for circular interpolation	--	Format 1: G17
G18	XZ plane for circular interpolation	--	Format 1: G18
G19	YZ plane for circular interpolation	--	Format 1: G19
G90	Absolute mode	--	Format 1: G90
G91	Relative mode	--	Format 1: G91
G50	Precise stop	--	Format 1: G50
G51	Round path transition	--	Format 1: G51 D_
G52	Smooth path transition	--	Format 1: G52
M0~M99	M Code	--	Format 1: M_ D_

Note:

The location with an underline is the value of the parameter to be set.

When one G code need be input in the CNC program in the CANopen Builder, N_ must be put to the left of G code. N_ means the row number of the G code in the NC program.

Every row has only one G code input.

The input format of G codes in the CANopen Builder software is as follows.

N0 G0 X100 Y100

11.6.3 Explanation of G Code Formats

- **G code Unit**

The position unit of axis X_, Y_, Z_, A_, B_, C_, P_, Q_ in G code is consistent with that of axis parameter. Please set the same physical unit for each axis.

For example, the unit is set as mm. And thus G0 X100.5 Y300 Z30.6 indicates that axis X, Y, Z move to the place of 100.5mm, 300mm, and 30.6mm respectively.

- **G code parameter omitting**

1. One or more items among X_, Y_, Z_, A_, B_, C_, P_, Q_ in G0 instruction can be omitted.
2. One or more items among X_, Y_, Z_, A_, B_, C_, P_, Q_, E_, E_, F_ in G1 instruction can be omitted.
3. One or more items among X_, Y_, Z_, A_, B_, C_, P_, Q_, E_, E_, F_ in G2 and G3 instruction can be omitted except I_, J_, K_, R_.
4. The parameters on the right of G4, G51 instruction can not be omitted.
5. D_ can be omitted for M code.
6. Only one G code can be written in the same row in CNC editing area in the CANopen Builder software.

- **Special function of G code**

- **Using %ML register to represent key values in G code**

X_, Y_, Z_, A_, B_, C_, P_, Q_, E_, F_, I_, J_, K_, R_, T_, E_, F_ all can use %ML register. “%” of “%ML” is deleted and “\$” is added to the right and left of “ML”. T is of ULINT type and others are of LREAL type.

Example: N0 G0 X\$ML0\$ Y\$ML1\$ Z\$ML2\$ (%ML0=100.0 · %ML1=200.0 · %ML2=300.0)

Explanation: After the G code is executed, axis X moves to 100 units; axis Y moves to 200 units and axis Z moves to 300 units.

- **G code transition**

G code transition mode can be changed via G50/G51/G52. See the transition modes which are usable to G0/G1/G2/G3 as follows.

	G50 (Precise stop)	G51 (Round path transition)	G52 (Smooth path transition)
G0	Usable	The transition mode is invalid and the motion effect is the same as G50.	The transition mode is invalid and the motion effect is the same as G50.
G1	Usable	Usable	Usable
G2	Usable	Usable	The transition mode can be used when the straight line or circular arc and circular arc are tangent or are close to the point of tangency.
G3	Usable	Usable	The transition mode can be used when the straight line or circular arc and circular arc are tangent or are close to the point of tangency.

- **Defaults**

1. Relative, absolute default: The default mode is absolute mode and could be set via G90/G91.
2. Plane default: The default plane is XY plane and could be switched via G17/G18/G19.
3. Transition mode: The default plane is an accurate stop mode and could be switched via G50/G51/G52.
4. G0-related defaults: The velocity, acceleration, deceleration and jerk are the velocity, acceleration, deceleration and jerk of each axis in the axis group parameters. They can be set via DMC_SetG0Para instruction.

5. G1/G2/G3 defaults: The velocity, acceleration, deceleration and jerk are the velocity, acceleration, deceleration and jerk of terminal actuator. They can be set via DMC_SetG1Para instruction and modified via E, F parameter. E+ and E- can be input in G code to set the different acceleration and deceleration rate.

Example: G1 X10000 Y32105.6 E+20000 E-90000

Explanation: When the instruction is executed, the cutter moves at the acceleration of 20000 units/second² for speeding up and at the deceleration of 90000 units/second² for reducing the speed.

11.6.4 G Code Functions

11.6.4.1 G90 (Absolute Mode)

- Function: After G90 is executed, the terminal position of each axis in G code is based on 0 unit and G91 can be used to switch into the relative mode in the process. It is absolute mode for NC program by default.
- Format: N_G90
- Parameter Explanation:
- N_ : The row number of G code in NC program
- Example:

The initial positions of axis X and Y are both 3000 units and the axis parameters are both default values. The G codes to be executed are as follows:

```
N0 G90
```

```
N1 G0 X6000 Y6000
```

After G codes are executed, the Y/X curve for the whole movement process is shown below:

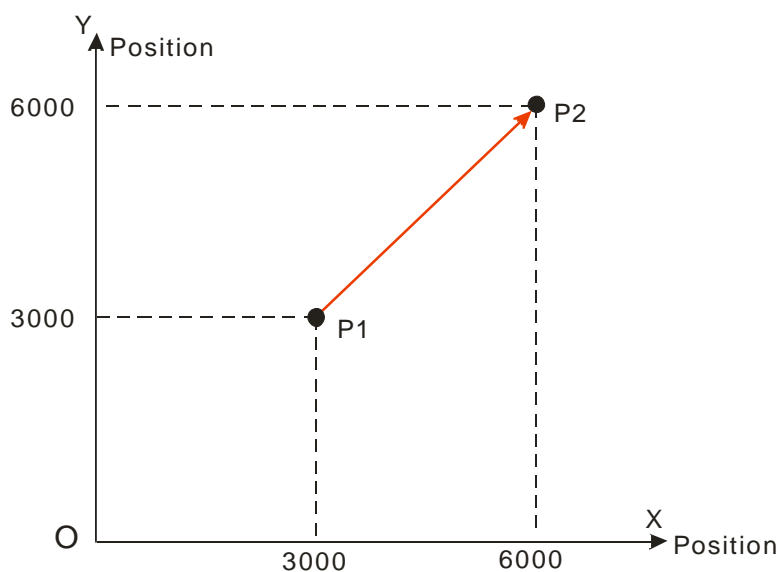

11.6.4.2 G91 (Relative Mode)

- Function: After G91 is executed, the terminal position of each axis in G code is counted in incremental method beginning from the current position and G90 can be used to switch into the absolute mode in the process.
- Format: N_G91
- Parameter Explanation:
- N_: The row number of G code in NC program
- Example:
The initial positions of axis X and Y are both 3000 units and the axis parameters are both default values. The G codes to be executed are as follows:
N0 G91
N1 G0 X6000 Y6000
After G codes are executed, the Y/X curve for the whole movement process is shown below:

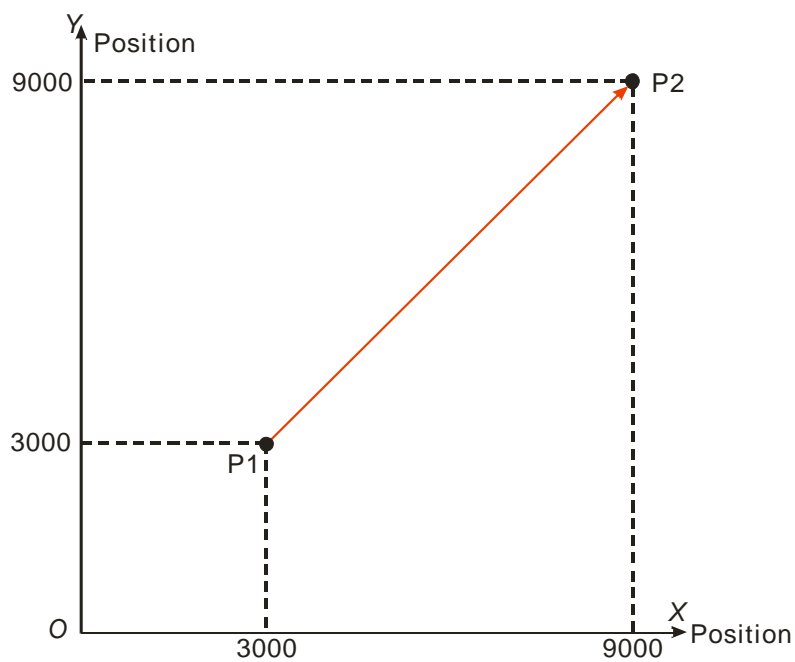

11.6.4.3 GO (Rapid Positioning)

- Function:

Each axis moves from current position to the terminal position at the given speed. Maximum 8 axes can be controlled and each axis is independent with each other in motion. And the motion path figure is displayed below.

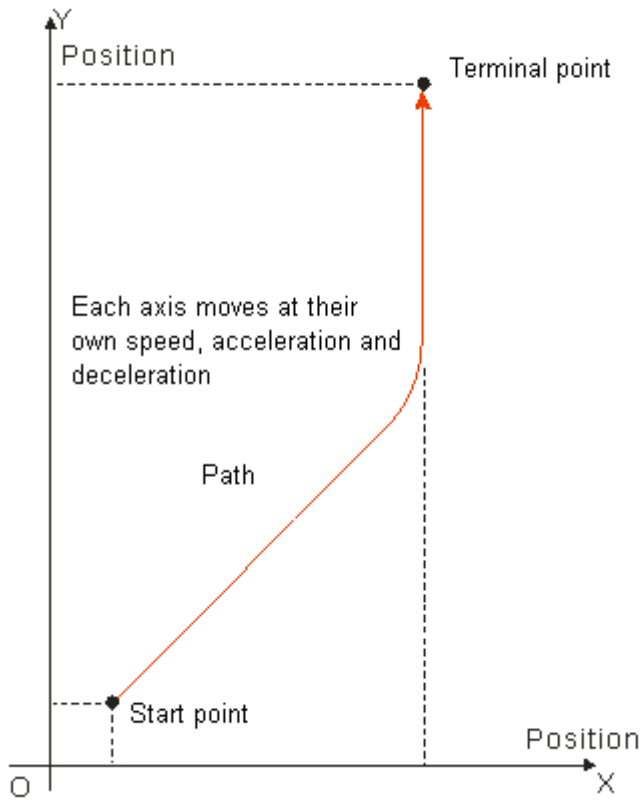

➤ Format: N_G0 X_Y_Z_A_B_C_P_Q_

➤ Parameter explanation:

N_: The row number of G code in NC program.

X_: Specify the terminal position of axis X, Unit: unit, data type: LREAL.

Y_: Specify the terminal position of axis Y, Unit: unit, data type: LREAL.

Z_: Specify the terminal position of axis Z, Unit: unit, data type: LREAL.

A_: Specify the terminal position of axis A, Unit: unit, data type: LREAL.

B_: Specify the terminal position of axis B, Unit: unit, data type: LREAL.

C_: Specify the terminal position of axis C, Unit: unit, data type: LREAL.

P_: Specify the terminal position of axis P, Unit: unit, data type: LREAL.

Q_: Specify the terminal position of axis Q, Unit: unit, data type: LREAL.

● Instruction explanation:

1. G0 can control one or more axes and other axis can be omitted.
2. The speed, acceleration, deceleration and jerk of each axis in motion depend on axis-related parameters in axis group parameters. They can be set via DMC_SetG0Para instruction.
3. Absolute mode decided by G90: The terminal position of G0 is based on 0 unit.
4. Relative mode decided by G91: The terminal position of G0 is an incremental value beginning

from the current position.

■ Absolute mode example:

The initial positions of axis X, Y are both 10000 units and their axis parameters are both default values.

The G codes to be executed are:

N0 G90

N1 G0 X50000 Y100000

- After G codes are executed, the Y/X curve for the whole movement process is shown below:

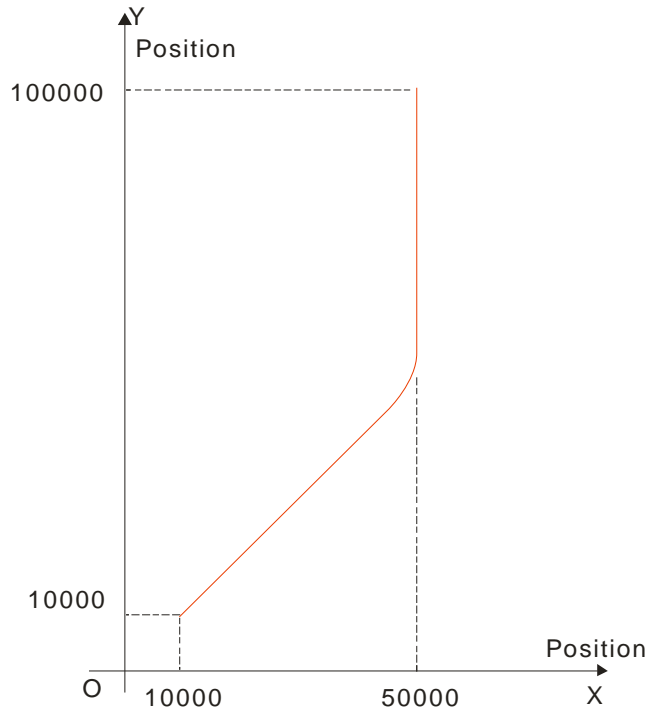

- After G codes are executed, the Position/Time curve for the whole movement process is shown below:

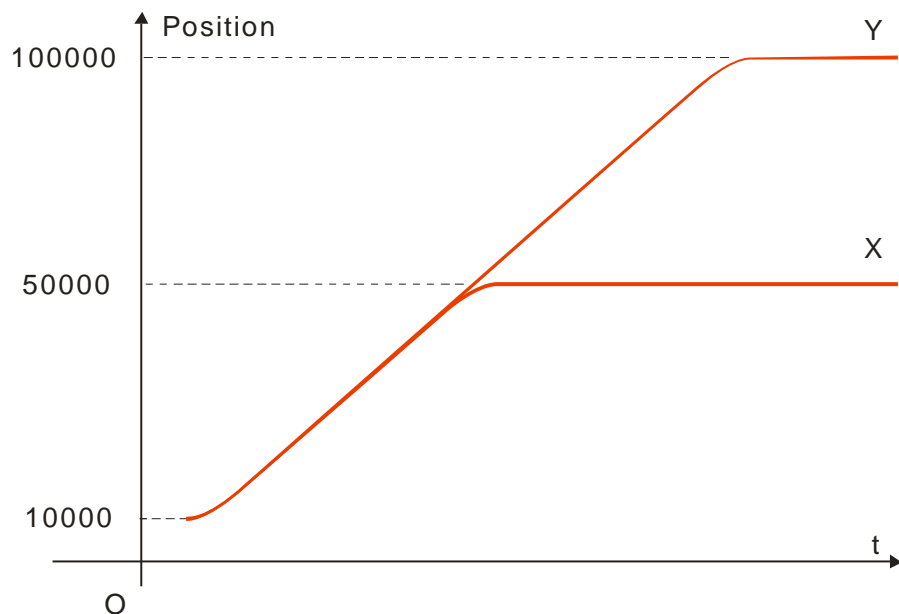

11

- Relative mode example:
 The initial positions of axis X, Y are both 10000 units and their axis parameters are both default values. The G codes to be executed are:
 N0 G91
 N1 G0 X50000 Y100000

➤ After G codes are executed, the Y/X curve for the whole movement process is shown below:

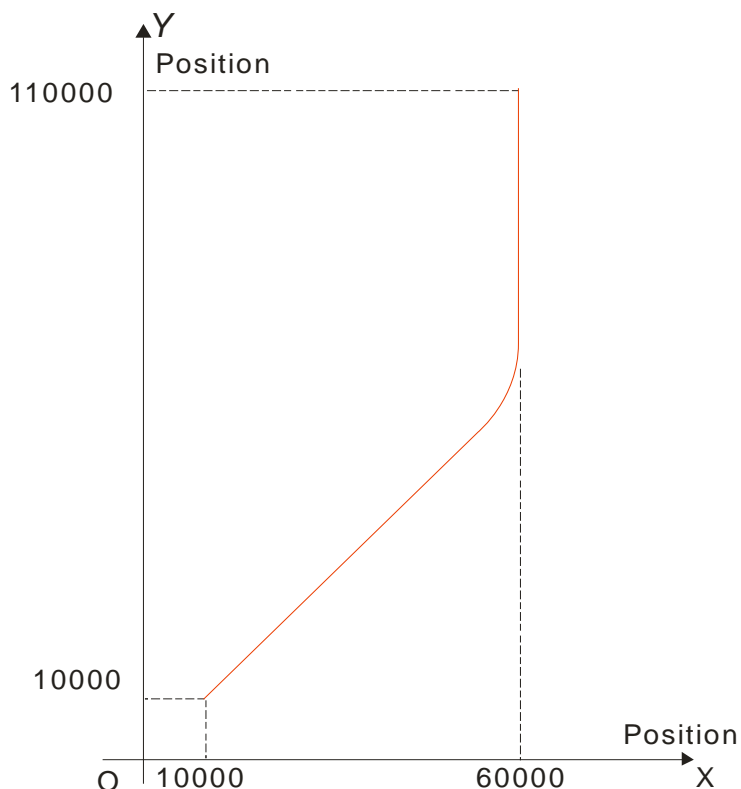

➤ After G codes are executed, the Position/Time curve for the whole movement process is shown below:

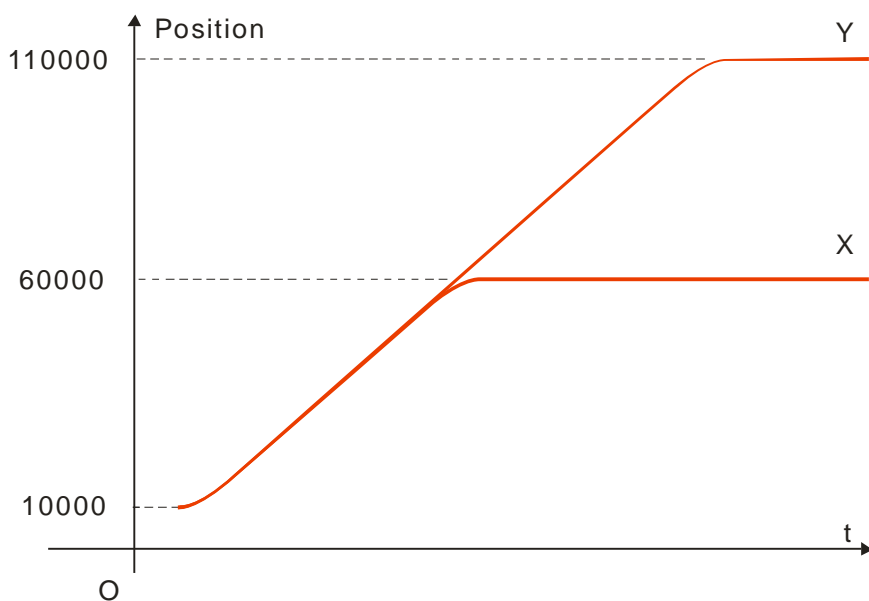

11.6.4.4 G1 (Linear Interpolation)

- Function:

The cutter starts off from one point and moves straight to the target position at a given speed. The instruction can control up to 8 axes and all axes start up or stop simultaneously. Three axes control the position of the cutter together as the figure shows below.

11

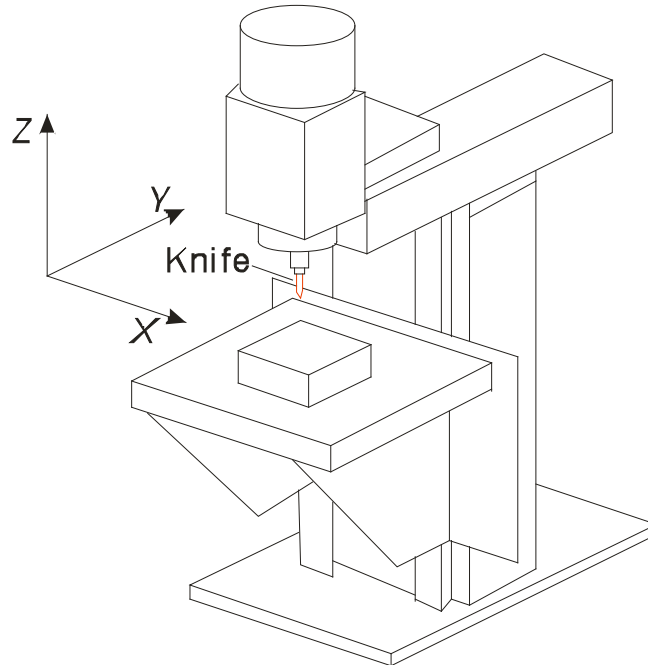

Vertical Milling Machine

Motion path figure:

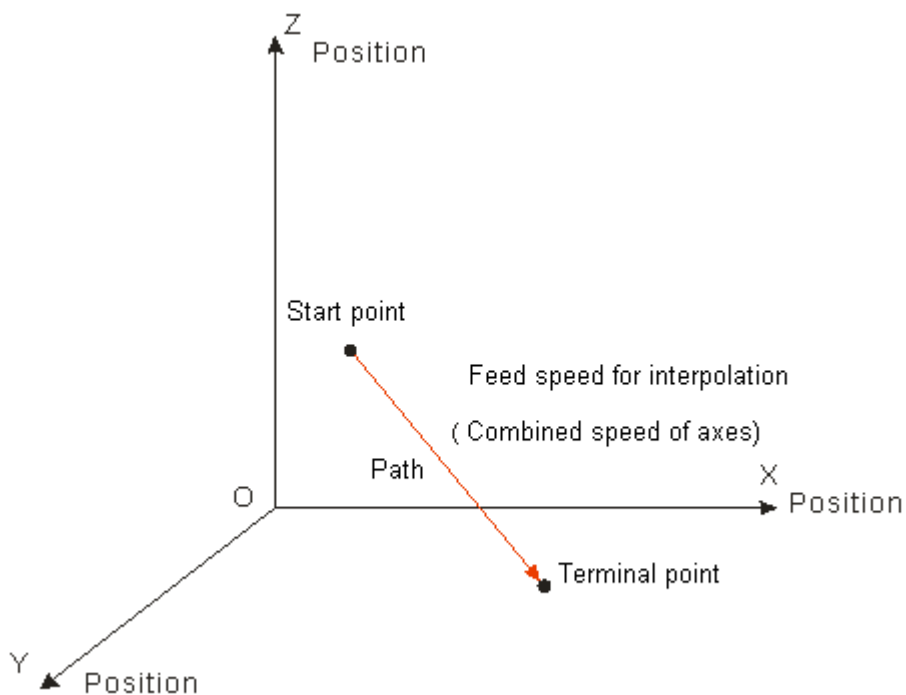

- Format: N_G1 X_Y_Z_A_B_C_P_Q_E_E_F_
- Parameter explanation:

N_: The row number of G code in NC program

X_: Specify the terminal position of axis X, Unit: unit, data type: LREAL.

Y_: Specify the terminal position of axis Y, Unit: unit, data type: LREAL.

Z_: Specify the terminal position of axis Z, Unit: unit, data type: LREAL.

A_: Specify the terminal position of axis A, Unit: unit, data type: LREAL.

B_: Specify the terminal position of axis B, Unit: unit, data type: LREAL.

C_: Specify the terminal position of axis C, Unit: unit, data type: LREAL.

P_: Specify the terminal position of axis P, Unit: unit, data type: LREAL.

Q_: Specify the terminal position of axis Q, Unit: unit, data type: LREAL.

E_: Specify the acceleration and deceleration of the cutter. The positive number refers to the acceleration; the negative number refers to the deceleration; unit: unit/second²; data type: LREAL.

F_: Specify the feed speed of the cutter, unit: unit/second, data type: LREAL.

When the cutter moves at a constant speed, the combined speed of all axes in G code is equal to F value.

The method of calculation is shown as below.

When two axes exist, $F = \sqrt{V_1^2 + V_2^2}$.

When three axes exist, $F = \sqrt{V_1^2 + V_2^2 + V_3^2}$.

For more axes, F value could be calculated in the same way as above.

- Instruction explanation:

1. G1 can control one or more axes and other axis can be omitted.
2. Both of E and F can be omitted.

If there is only one row of code in the CNC editing area and E, F are omitted, the velocity, acceleration, deceleration and jerk are decided by the axis group parameters. They can be set via DMC_SetG1Para. If there are multiple rows of codes and E and F in G1 code are omitted, the velocity, acceleration, deceleration of the cutter are based on valid E and F in the previous rows of codes. If the previous rows of G codes have not specified E and F, the axis group parameters will prevail.

3. Absolute mode decided by G90: The terminal position of G1 is based on 0 unit.
4. Relative mode decided by G91: The terminal position of G1 is an incremental value beginning from the current position.

- Absolute mode example:

The initial positions of axis X, Y, Z are all 20000 units and their axis parameters are all default values. The G codes to be executed are:

```
N0 G90
```

```
N1 G1 X50000 Y60000 Z70000
```

After G codes are executed, the Y/X curve for the whole movement process is shown below:

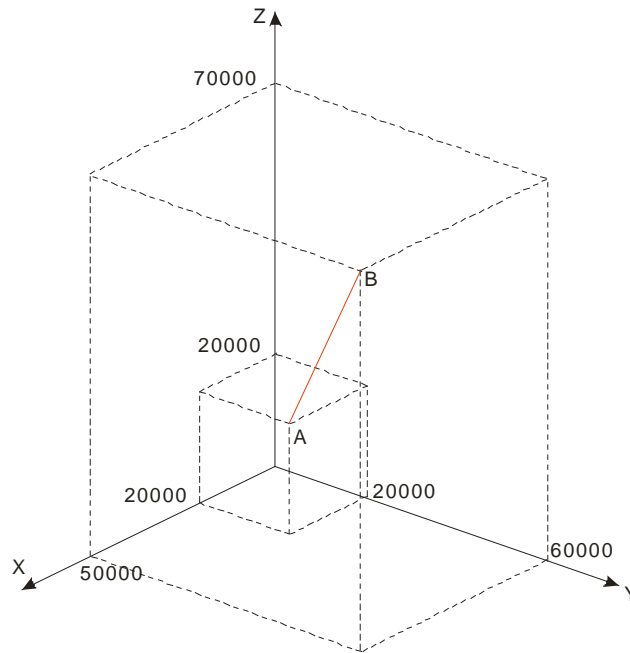

- After G codes are executed, the Position/Time curve for the whole movement process is shown below:

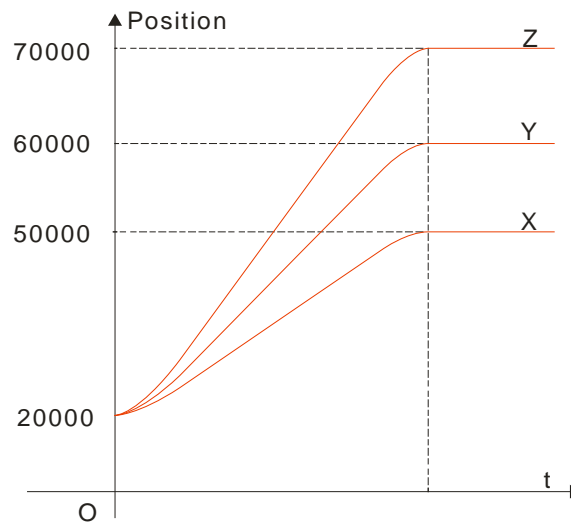

- Relative mode example:
The initial positions of axis X, Y, Z are all 20000 units and their axis parameters are all default value. The G codes to be executed are:
N0 G91
N1 G1 X50000 Y60000 Z70000
- After G codes are executed, the Y/X curve for the whole movement process is shown below:

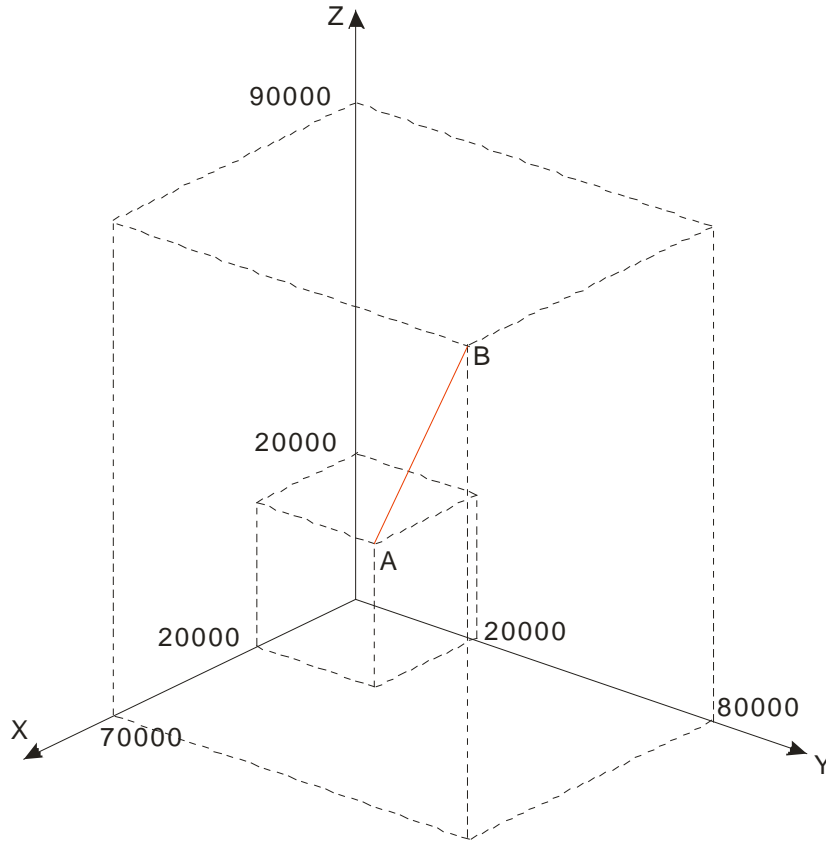

- After G codes are executed, the Position/Time curve for the whole movement process is shown below:

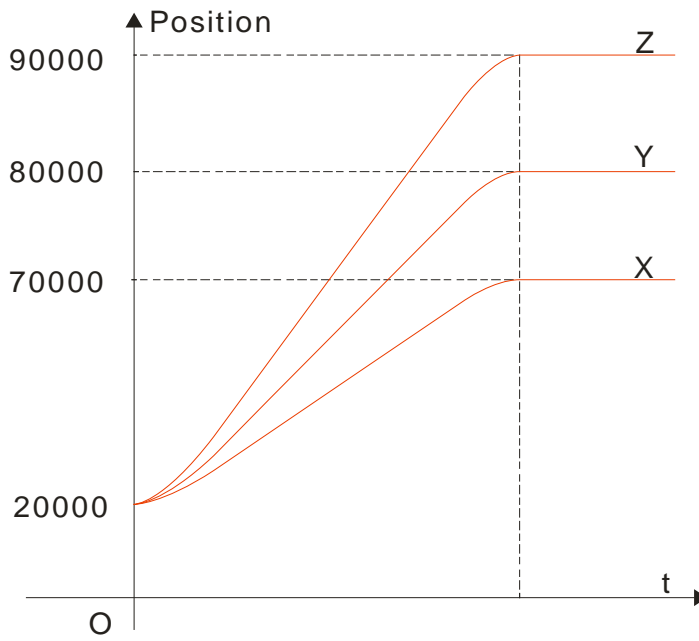

11.6.4.5 G2 (Clockwise Circular/ Helical Interpolation)

- Function:

Circular interpolation: The cutter conducts the cutting of the processed object in the clockwise direction at the feed speed given by parameter F on the circular arc with the fixed radius or the fixed center of a circle of the specified plane.

Helical interpolation: The cutter moves in the clockwise direction on the circular arc of the specified plane, which is circular interpolation and simultaneously moves in the vertical direction of the specified plane at the feed speed given by parameter F, which is linear interpolation.

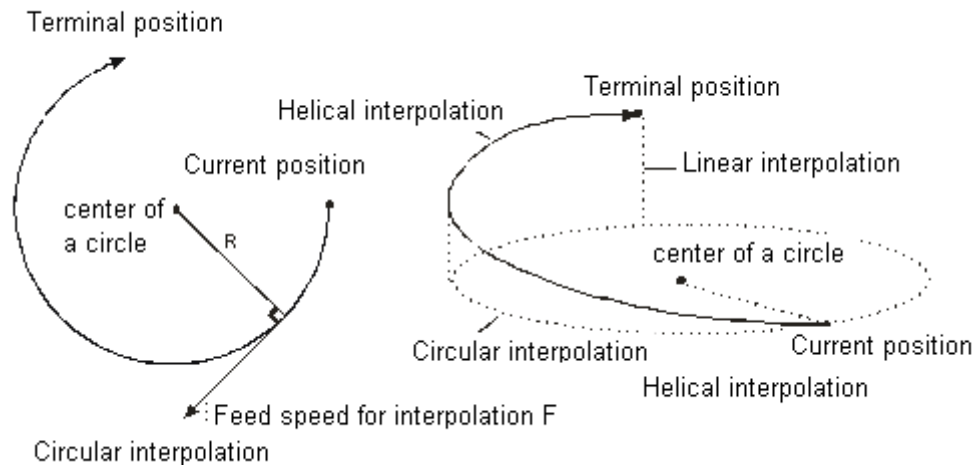

- Format:

Format 1: N_G2 X_Y_Z A_B_C_P_Q_I_J_(I_K_/J_K_)T_E_E_F_

Format 2: N_G2 X_Y_Z A_B_C_P_Q_R_T_E_E_F_

- Parameter explanation:

N_: The row number of G code in NC program

X_Y_Z_: Specify the terminal positions of axis X, Y and Z corresponding to the terminal point of circular arc; Unit: unit, data type: LREAL.

A_B_C_P_Q_: Specify the terminal position of each added axis, Unit: unit, data type: LREAL.

I_J_: Specify the coordinate position of the center of a circle of XY plane, Unit: unit, data type: LREAL.

I_K_: Specify the coordinate position of the center of a circle of XZ plane, Unit: unit, data type: LREAL.

J_K_: Specify the coordinate position of the center of a circle of YZ plane, Unit: unit, data type: LREAL.

T_: Specify the quantity of full circles, Unit: circle, data type: ULINT.

E_: Specify the acceleration and deceleration of the cutter. The positive number refers to the acceleration; the negative number refers to the deceleration; Unit: unit/second²; data type: LREAL.

F: Specify the feed speed of the cutter, Unit: unit/second, data type: LREAL.

- Instruction explanation:

1. Two axes among axis X, Y and Z make the circular interpolation on the plane specified by instruction G17/G18/G19. The 3rd axis makes the linear interpolation in the direction vertical on the specified plane.

2. The added axis A, B, C, P and Q make the linear interpolation. The linear interpolation and circular interpolation start up or stop simultaneously.

3. Both of E and F can be omitted. If there is only one row of code in the CNC editing area and E, F are omitted, the velocity, acceleration, deceleration are decided by axis group parameters. They can be set via DMC_SetG1Para instruction.

If there are multiple rows of codes and E and F in G2 code are omitted, the velocity, acceleration, deceleration of the cutter are based on valid E and F in the previous rows of codes above the row where G2 is. If the previous rows of G codes have not specified E and F,

“maximum velocity”, “maximum acceleration” and “maximum deceleration” among axis group parameters will prevail.

4. In absolute mode for G90, the terminal point of circular arc is the absolute coordinate value regarding 0 unit in their own directions as reference. In relative mode for G91, the terminal point of circular arc is the incremental value relative to the start point of circular arc.
5. No matter whether in the absolute mode or in relative mode, the coordinates of the center of a circle I_J_(I_K_/J_K_) are always relative coordinates with the start point as reference
6. T is the number of full circles; the path is a length of arc when T=0; it is the circle number of full circles plus the arc length when T is a constant.
7. Different from format 1, format 2 decides a circular arc via the start point, terminal point and radius. If the input value on the right of R parameter is a positive number (R+), the circular arc is the minor arc less than 180 degrees; if the input value on the right of R parameter is a negative number (R-), the circular arc is the major arc more than 180 degrees.
8. The following full lines are the motion path when G2 selects R+ and R- and the arrows on the arc indicate the motion direction.

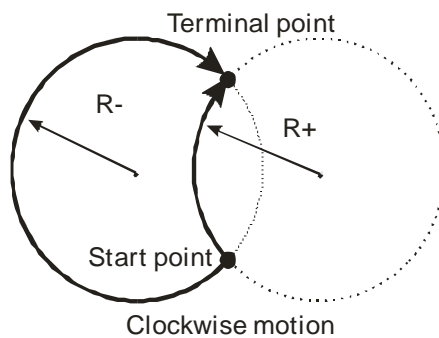

- The coordinate relations on different planes:

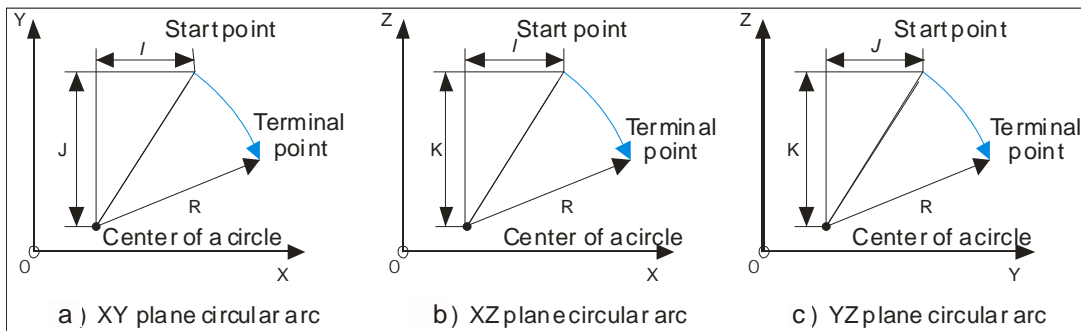

Please note the relations among the coordinate planes and I, J, K. Only two of I, J and K exist in one circular arc instruction. Which two exist depends on corresponding plane, e.g. on XY plane, only I and J show up.

The coordinate plane can be set by G17, G18 and G19. The circular and helical motion paths for G2 on different coordinate planes are shown as below.

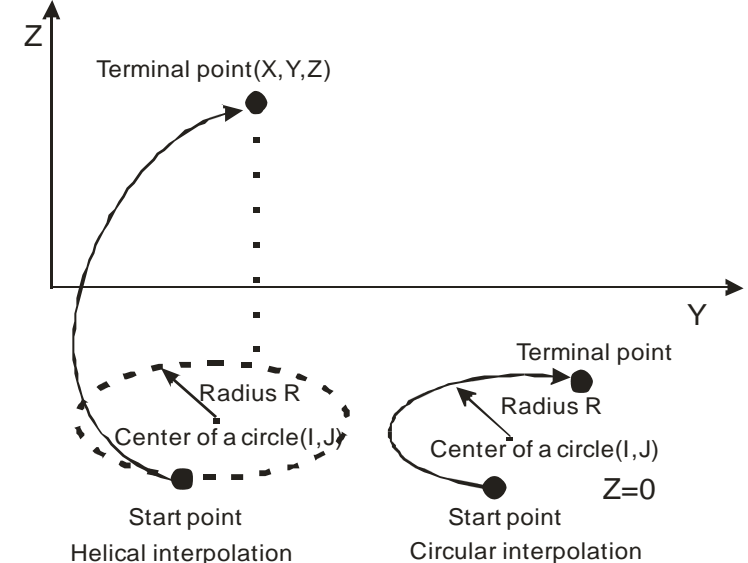
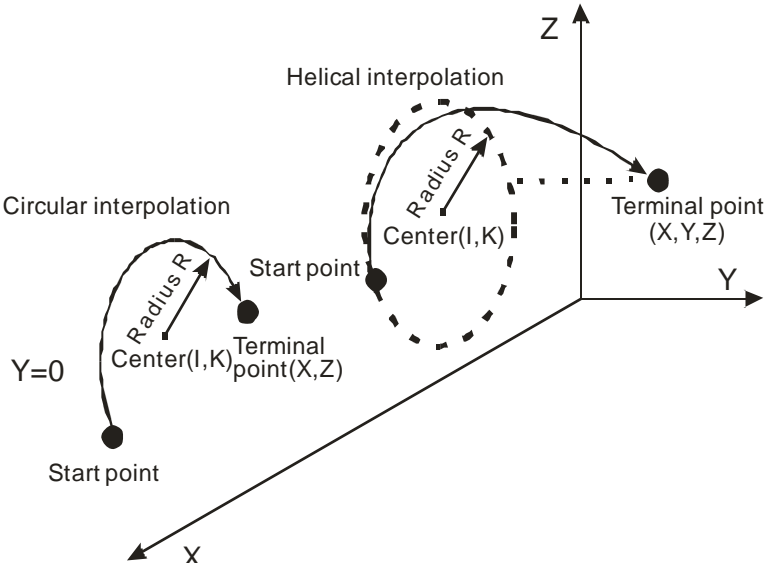
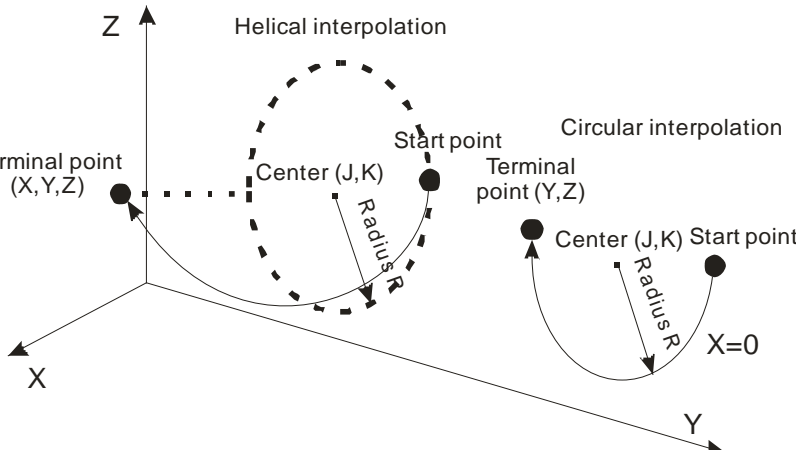
G code	Function	Path figure
G17	<p>XY plane: When there is no variation for the start point and terminal point corresponding to Z axis coordinates, the motion path is circular interpolation. Otherwise, it is helical interpolation.</p>	 <p>The diagram for G17 illustrates two types of interpolation in the XY plane. On the left, 'Helical interpolation' is shown in a 3D coordinate system with Z, Y, and X axes. A solid curve starts at a 'Start point' and ends at a 'Terminal point(X,Y,Z)'. A dashed circle in the XY plane represents the projection of the path, with its center labeled 'Center of a circle(I,J)' and radius 'R'. On the right, 'Circular interpolation' is shown in a 2D XY plane. A solid arc starts at a 'Start point' and ends at a 'Terminal point'. The center is labeled 'Center of a circle(I,J)' and the radius is 'R'. The Z-axis is indicated as 'Z=0'.</p>
G18	<p>XZ plane: When there is no variation for the start point and terminal point corresponding to Y axis coordinates, the motion path is circular interpolation. Otherwise, it is helical interpolation.</p>	 <p>The diagram for G18 illustrates two types of interpolation in the XZ plane. On the left, 'Circular interpolation' is shown in a 2D XZ plane where Y=0. A solid arc starts at a 'Start point' and ends at a 'Terminal point(X,Z)'. The center is labeled 'Center(I,K)' and the radius is 'R'. On the right, 'Helical interpolation' is shown in a 3D coordinate system with Z, Y, and X axes. A solid curve starts at a 'Start point' and ends at a 'Terminal point(X,Y,Z)'. A dashed circle in the XZ plane represents the projection of the path, with its center labeled 'Center(I,K)' and radius 'R'.</p>
G19	<p>YZ plane: When there is no variation for the start point and terminal point corresponding to X axis coordinates, the motion path is circular interpolation. Otherwise, it is helical interpolation.</p>	 <p>The diagram for G19 illustrates two types of interpolation in the YZ plane. On the left, 'Helical interpolation' is shown in a 3D coordinate system with Z, Y, and X axes. A solid curve starts at a 'Start point' and ends at a 'Terminal point(X,Y,Z)'. A dashed circle in the YZ plane represents the projection of the path, with its center labeled 'Center(J,K)' and radius 'R'. On the right, 'Circular interpolation' is shown in a 2D YZ plane where X=0. A solid arc starts at a 'Start point' and ends at a 'Terminal point(Y,Z)'. The center is labeled 'Center(J,K)' and the radius is 'R'.</p>

Example 1

- Specify the center of a circle and conduct a circular interpolation in absolute mode
 - Current position (1000, 3000), axis parameters: default values, the G codes to be executed:
 N00 G90
 N01 G17
 N02 G2 X4000 Y2000 I1000 J-2000 E5000 F5000
 - After G codes are executed, the Y/X curve for the whole movement process is shown below:

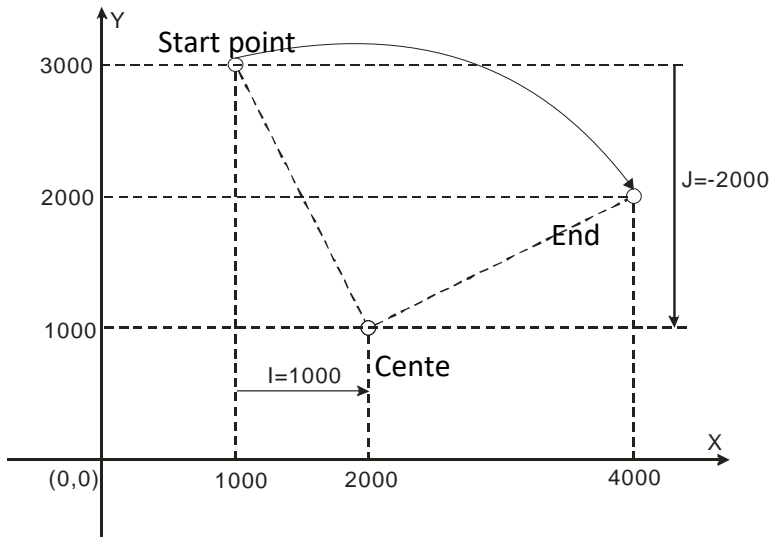

Example 2:

- Specify the center of a circle and conduct a circular interpolation in relative mode
 - Current position (1000, 3000), axis parameters: default values, the G codes to be executed:
 N00 G91
 N01 G17
 N02 G2 X3000 Y-1000 I1000 J-2000
 - After G codes are executed, the Y/X curve for the whole movement process is shown below:

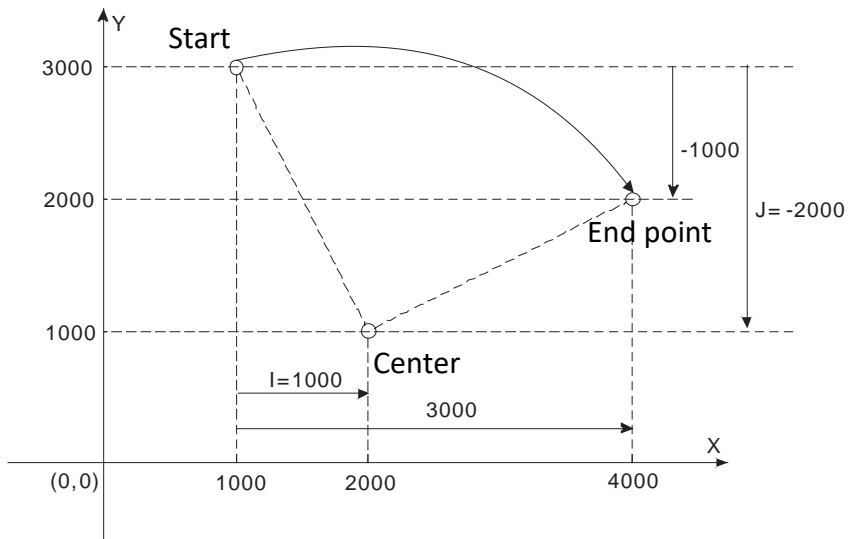

**Example 3:**

- Specify the center of a circle and conduct a circular interpolation with T in relative mode
 - Current position (2000, 0), axis parameters: default values, the G codes to be executed:

```
N00 G91
          N01 G17
          N02 G2 X-2000 Y2000 I0 J2000 T3
```
 - After G codes are executed, the path of the circular arc is 3 circles plus thick 1/4 of a circle. The Y/X curve for the whole movement process is shown below:

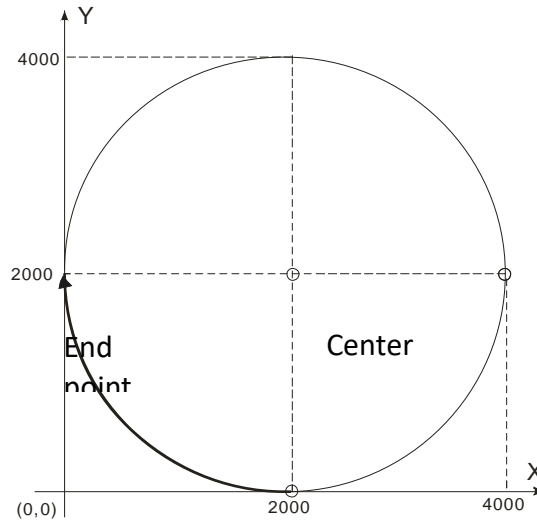
**Example 4:**

Start point

- **The helical interpolation with the center specified by XY plane**

Current position (0, 0), axis parameters: default values, the G codes to be executed:

```
N00 G17
```

```
N01 G91
```

```
N02 G2 X200 Y200 Z200 I100 J100 E+10000 E-20000 F1000
```

- **Instruction explanation:**

While G2 is being executed, axis regards 0 as the start point and axis coordinate parameters as the end points; the circular arc is drawn in clockwise direction; the final motion path is a helical curve. The projection on XY plane is an half of the circle with the center (100,100).

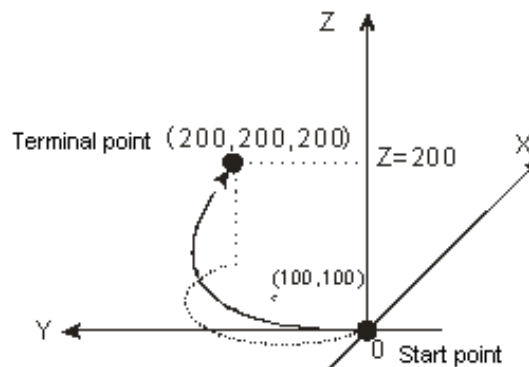

**Example 5:**

- **Omission format**

The G codes to be executed are:

N00 G0 X0 Y0 Z0

N01 G1 X100 Y100 Z100

N02 G2 I100 J100

N03 G91

N04 G2 I50 J50

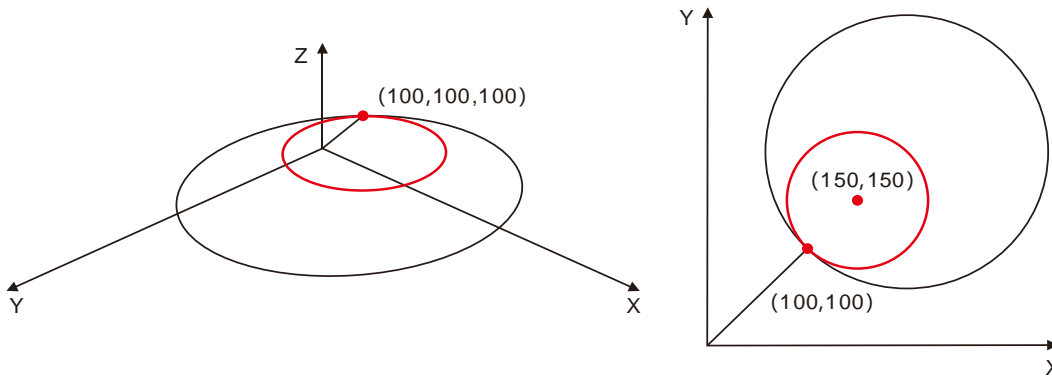

- **Instruction explanation:**

1. The axis position is (100, 100, 100) after execution of N01 row of instruction is finished;
2. In N02 row of instruction, there are only I and J parameters and for other omitted parameter values, they are based on those valid in the last instruction. In other words, the N02 instruction is equivalent to: N02 X100 Y100 Z100 I100 J100. So both of the start point and end point are (100, 100, 100) and the motion path is a full circle.
3. N03 row of instruction is G91 and the following coordinates are relative.
Since X, Y and Z are omitted in N04 row of instruction, the terminal position are an absolute position (100, 100, 100). Thus the N04 path is a full circle with the start point (100,100,100) and end point of (100,100,100) and the center is (150,150).

**Example 6:**

- Helical interpolation with the radius specified by XY plane (Current position: 0)

The G codes to be executed are:

N00 G2 X200 Y200 Z200 R-200

N01 G0 X0 Y0 Z0

N02 G2 X200 Y200 Z200 R200

- **Instruction explanation:**

The motion path is a major arc while the first G2 code is executed and it is a minor arc while the second G2 code is executed.

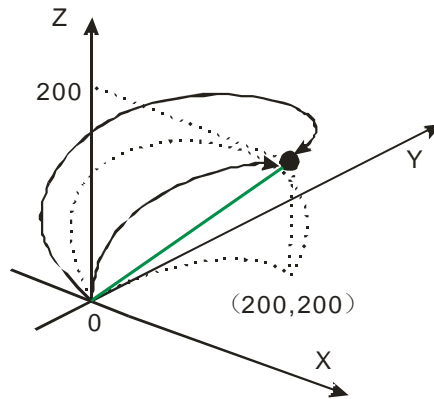
**Example 7:**

- The helical interpolation with T and the center specified on XY plane (Current position: 0)

The G codes to be executed are:

```
N00 G2 X100 Y100 Z100 I50 J50 T2
```

- **Instruction explanation:**

The motion path is a helical curve and the projection on XY plane is a full circle with the center (50, 50).

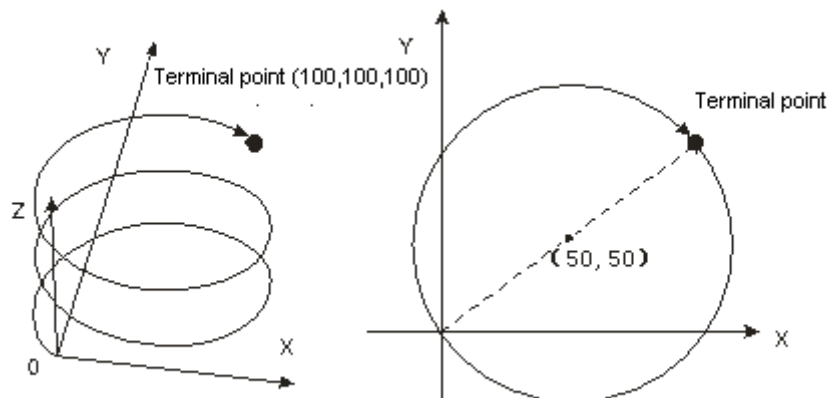

11.6.4.6 G3 (Anticlockwise Circular /Helical Interpolation)

- Function explanation:

Circular interpolation: The cutter conducts the arc cutting of the processed object in the anticlockwise direction at the feed speed given by parameter F on the circular arc with the fixed radius or the fixed center on the specified plane.

Helical interpolation: The cutter moves in the anticlockwise direction on the circular arc of the specified plane, which is a circular interpolation and simultaneously moves in the direction vertical to the specified plane at the feed speed given by parameter F, which is linear interpolation.

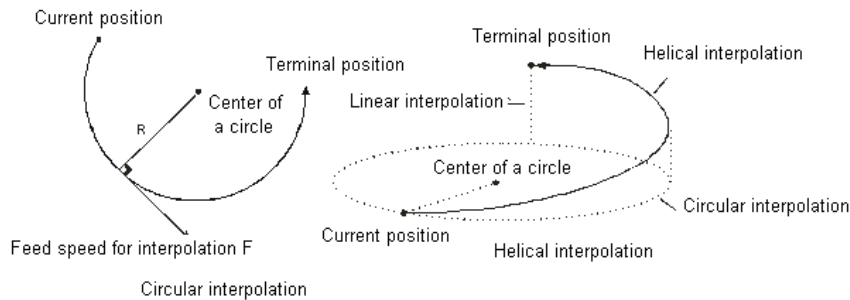

- Format:

Format1: N_G3 X_Y_Z_A_B_C_P_Q_I_J_(I_K_/J_K_)T_E_E_F_

Format2: N_G3 X_Y_Z_A_B_C_P_Q_R_T_E_E_F_

- Parameter explanation:

N_: The row number of G code in NC program

X_Y_Z_: Specify the terminal positions of axis X, Y and Z corresponding to the terminal point of circular arc; Unit: unit, data type: LREAL.

A_B_C_P_Q_: Specify the terminal positions of added axes, Unit: unit, data type: LREAL.

I_J_: Specify the coordinate position of the specified center on XY plane, Unit: unit, data type: LREAL.

I_K_: Specify the coordinate position of the specified center on XZ plane, Unit: unit, data type: LREAL.

J_K_: Specify the coordinate position of the specified center on YZ plane, Unit: unit, data type: LREAL.

T_: Specify the circle number of full circles, Unit: circle, data type: ULINT.

E_: Specify the acceleration and deceleration of the cutter. The positive number indicates the acceleration; the negative number indicates the deceleration, Unit: unit/second², data type: LREAL.

F: Specify the feed speed of the cutter, Unit: unit/second, data type: LREAL.

- Instruction explanation:

- Two axes among axis X, Y and Z make the circular interpolation on the plane specified by G17/G18/G19. The 3rd axis makes the linear interpolation in the direction vertical to the specified plane.

- The added axis A, B, C, P and Q make the linear interpolation. The linear interpolation and circular interpolation start up or stop simultaneously.

- Both of E and F can be omitted. If there is only one row of code in the CNC editing area and E, F are omitted, the velocity, acceleration and deceleration are decided by the axis group parameters.

If there are multiple rows of codes and E and F in G3 code are omitted, the velocity, acceleration and deceleration of the cutter are based on valid E and F in the previous rows of codes above the row where G3 is. If the previous rows of G codes have not specified E and F, "maximum velocity", "maximum acceleration" and "maximum deceleration" among axis group parameters will prevail.

- In absolute mode for G90, the terminal point of a circular arc is of absolute coordinate values regarding 0 unit in their respective directions as reference. In relative mode for G91, the terminal point of a circular arc is of incremental values relative to the start point of the circular arc.

- No matter whether in the absolute mode or in relative mode, the coordinates of the center of a circle I_J_(I_K_/J_K_) are always the relative coordinates with the start point as

reference.

- T is the number of full circles; the path is a length of arc when $T=0$; the path is the corresponding full circles plus the arc length when T is a constant.
- Different from format 1, format 2 determines a length of circular arc via the start point, terminal point and radius. If the input value on the right of R parameter is a positive number (R+), the circular arc is a minor arc less than 180 degrees; if the input value on the right of R parameter is a negative number (R-), the circular arc is a major arc more than 180 degrees.
- The following full lines are the motion paths when G3 selects R+ and R- and the arrows on the arcs refer to the motion direction.

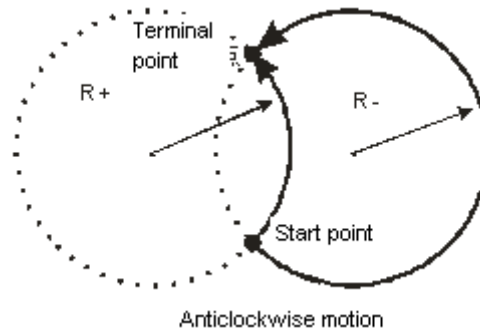

- The coordinate relations on different planes:

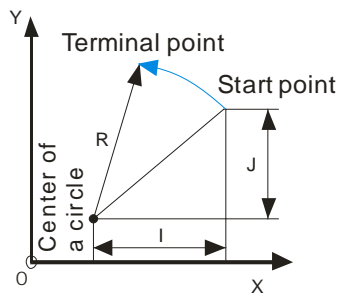

a) XY plane circular arc

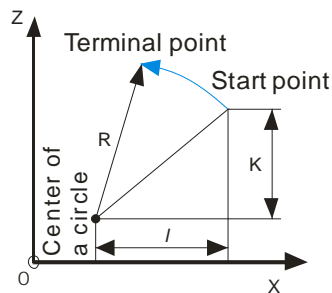

b) XZ plane circular arc

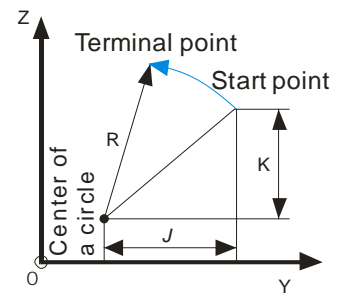

c) YZ plane circular arc

Please note the relations among the coordinate planes and I, J, K. Only two of I, J and K exist in one circular arc instruction. Which two exist depends on the corresponding plane, e.g. on XY plane, only I and J exist.

The coordinate plane can be set by G17, G18 and G19. The circular and helical motion paths for G3 on different coordinate planes are shown as below.

11

G code	Function	Path figure
G17	<p>XY plane: When there is some variation for the start point and terminal point corresponding to Z axis coordinates, the motion is helical interpolation. Otherwise, it is circular interpolation on XY plane.</p>	<p>Terminal point(X,Y,Z)</p> <p>Center (I,J)</p> <p>Radius R</p> <p>Start point</p> <p>Helical interpolation</p> <p>Terminal point(X,Y)</p> <p>Center (I,J)</p> <p>Radius R</p> <p>Start point</p> <p>Z=0</p> <p>Circular interpolation</p>
G18	<p>XZ plane: When there is variation for the start point and terminal point corresponding to Y axis coordinates, the motion is helical interpolation. Otherwise, it is circular interpolation on XZ plane.</p>	<p>Helical interpolation</p> <p>Terminal point(X,Y,Z)</p> <p>Center (I,K)</p> <p>Radius R</p> <p>Start point</p> <p>Circular interpolation</p> <p>Terminal point(X,Z)</p> <p>Center (I,K)</p> <p>Radius R</p> <p>Start point</p> <p>Y=0</p>
G19	<p>YZ plane: When there is variation for the start point and terminal point corresponding to X axis coordinates, the motion is helical interpolation. Otherwise, it is circular interpolation on YZ plane.</p>	<p>Helical interpolation</p> <p>Terminal point(X,Y,Z)</p> <p>Center (J,K)</p> <p>Radius R</p> <p>Start point</p> <p>Circular interpolation</p> <p>Terminal point(Y,Z)</p> <p>Center (J,K)</p> <p>Radius R</p> <p>Start point</p> <p>X=0</p>

**Example 1**

- Specify the center of a circle and circular interpolation in absolute mode
Current position (4000, 2000), axis parameters: default values, the G codes to be executed are:
N0 G90
N1 G17
N2 G3 X1000 Y3000 I-2000 J-1000
After G codes are executed, the Y/X curve for the whole movement process is shown below:

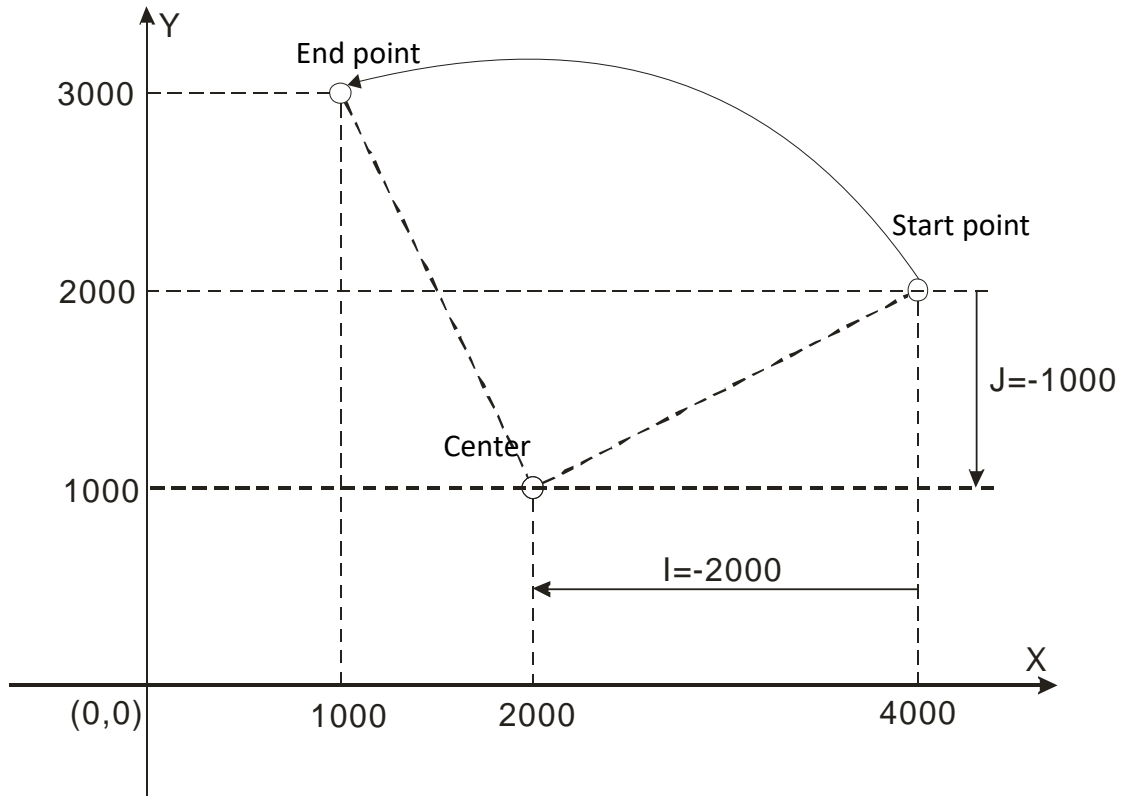
**Example 2**

- Specify the center of a circle and circular interpolation in relative mode
Current position (4000, 2000), axis parameters: default values, the G codes to be executed are:
N0 G91
N1 G17
N2 G3 X-3000 Y1000 I-2000 J-1000
After G codes are executed, the Y/X curve for the whole movement process is shown below:

11

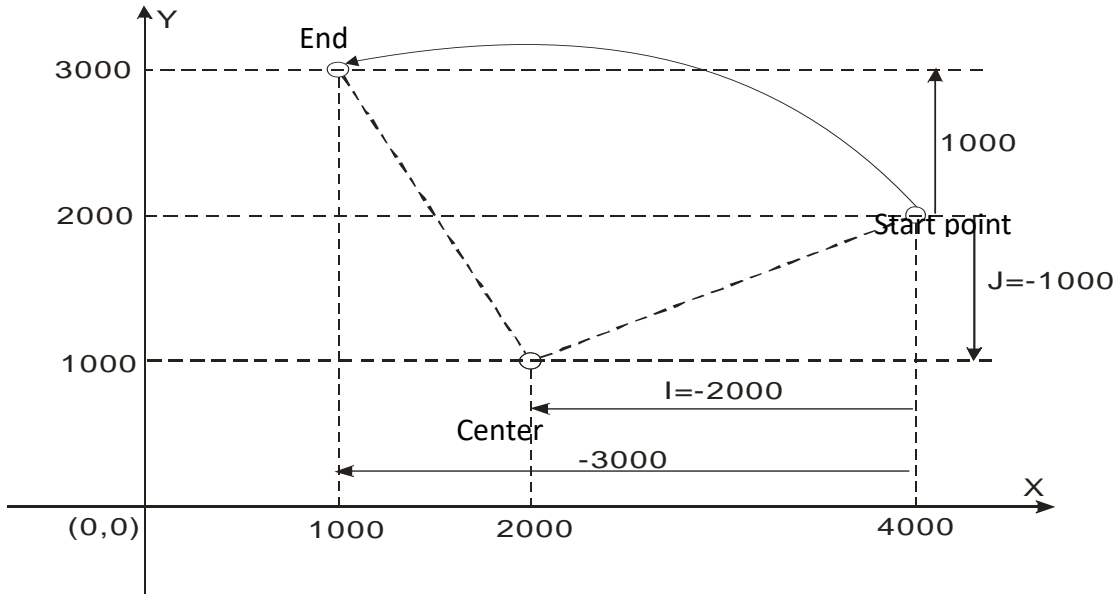

Example 3

- Specify the center of a circle and circular interpolation with T in relative mode
Current position (2000, 0), axis parameters: default values, the G codes to be executed are:

```
N0 G91
N1 G17
N2 G3 X-2000 Y2000 I0 J2000 T3
```

- Instruction explanation:
After G codes are executed, the motion path is the arc on XY plane and the arc length is (3+3/4) times the circumference of a circle.

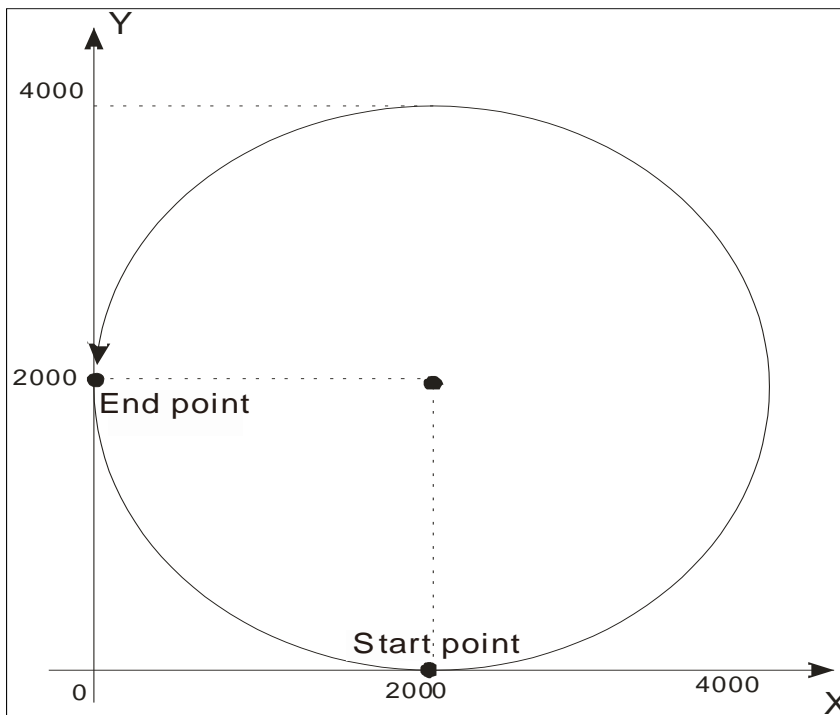

**Example 4**

- The helical interpolation with the center of a circle specified

Current position (0, 0), axis parameters: default values, the G codes to be executed are:

N0 G17

N1 G3 X100 Y100 Z100 I50 J50 T2

- Instruction explanation:

Since the variation of Z axis is 100, the motion path is helical curve and the projection on XY plane is a full circle.

If there is no variation for Z axis, the motion path is the circular arc on XY plane with the center (50,50) and the arc length of 2.5 times the circumference of a full circle.

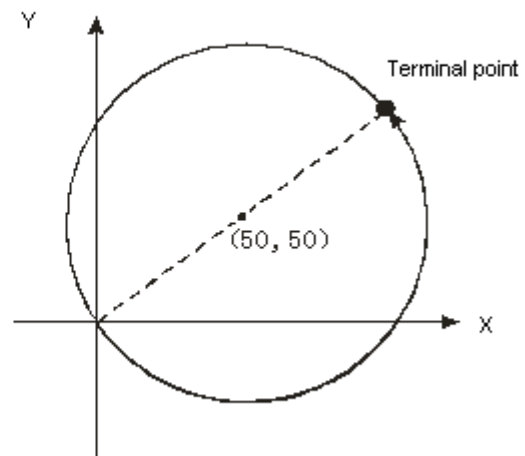
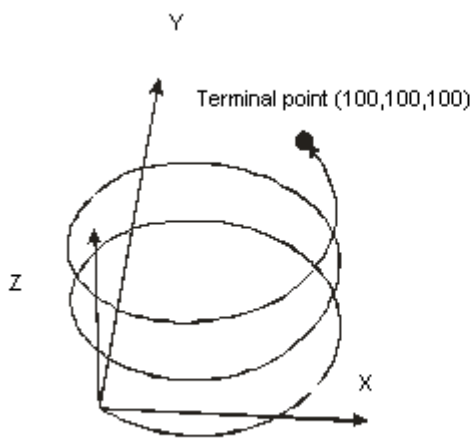

11.6.4.7 G17/G18/G19 (Specify Circular Interpolation Plane)

- Function:
The three instructions are used for deciding the selection of circular interpolation or helical interpolation plane and have no impact on the linear interpolation.
While the program is being executed, the three work planes can be switched with each other. If no plane option is set, the initial state of system is XY plane (G17).
- Format: N_G17
N_G18
N_G19
- Parameter Explanation:
N_: The row number of G code in NC program
- The figure of planes is shown as follows:

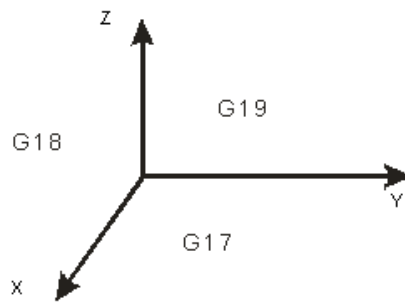

11.6.4.8 G4 (Dwell Instruction)

- Function: Dwell instruction
- Format: N_G4 K_
- Parameter explanation:
 - N_: The row number of G code in NC program
 - K_: Specify the delay time, unit: second. Range: 0.001 second ~100000 seconds
- Instruction explanation:

After the lathe completes the processing for some phase, the cutter need be stopped moving temporarily. At this moment, G4 can be utilized to make the cutter stop for a period of time.



Instruction example:

```
N00 G1 X10000
```

```
N01 G4 K10
```

```
N02 G1 X20000
```

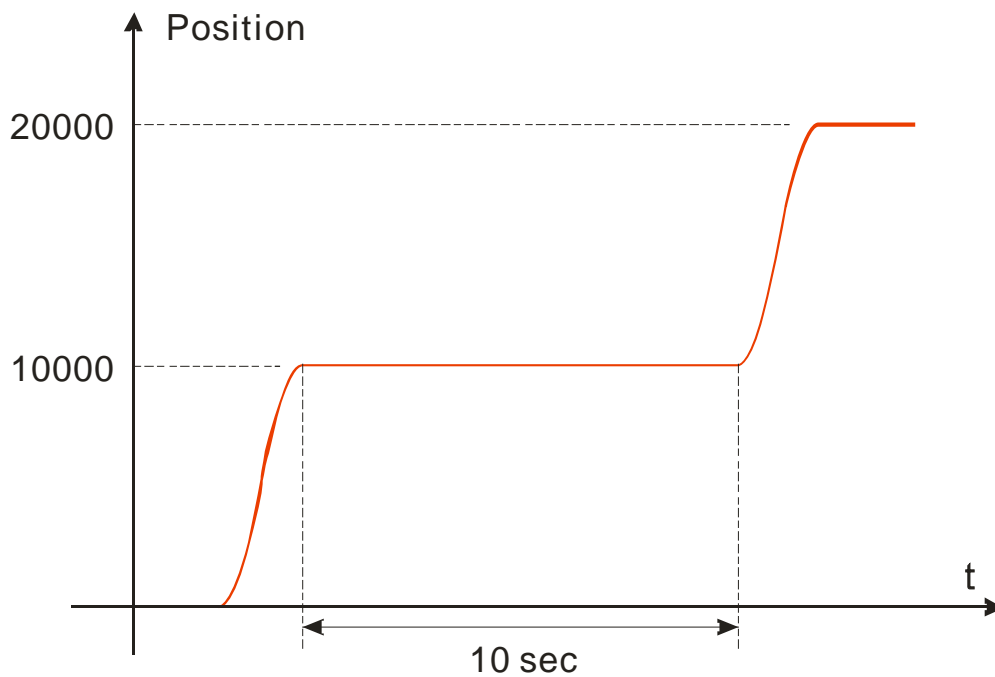

After execution of the instruction of number N0 is finished, the program will be delayed for 10 seconds and afterwards, the instruction of number N2 will continue to be executed.

11.6.4.9 G50 (Precise Stop)

- Function: Change the transition mode into precise stop. And the following transition modes are always precise stop. G51/G52 can be used for the switch in the execution process. The terminal actuator will reduce its speed to 0 between G codes.
- Format: N_ G50
- Parameter Explanation:
N_: The row number of G code in NC program



Example

```
N0 G50  
N1 G1 X100 Y100  
N2 G1 X300 Y100
```

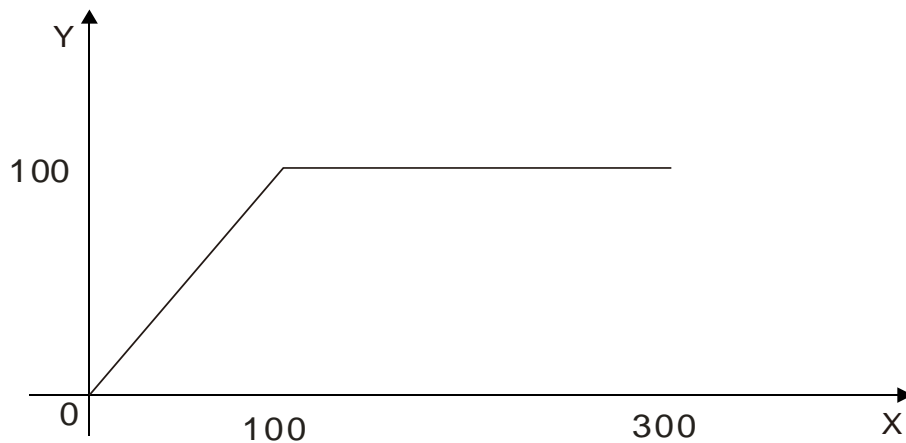

11.6.4.10 G51 (Round path transition)

- Function: To change the transition mode into arc transition. The following transition modes are always arc transition. G50/G52 can be used for the switch of transition modes in the execution process. The terminal actuator will not reduce its speed between G codes and the transition curve is an arc. In this mode, the speed of the first G code prevails as the entire motion speed and F can not be used for changing the speed in the motion. VelOverride parameter of DMC_CartesianCoordinate instruction can be set to control the speed of terminal actuator.
- Format: N_ G51 D_
- Parameter Explanation:
N_ : The row number of G code in NC program
D_ : Radius of the arc



Example 1

```
N0 G51 D40
N1 G1 X100 Y100
N2 G1 X300 Y100
```

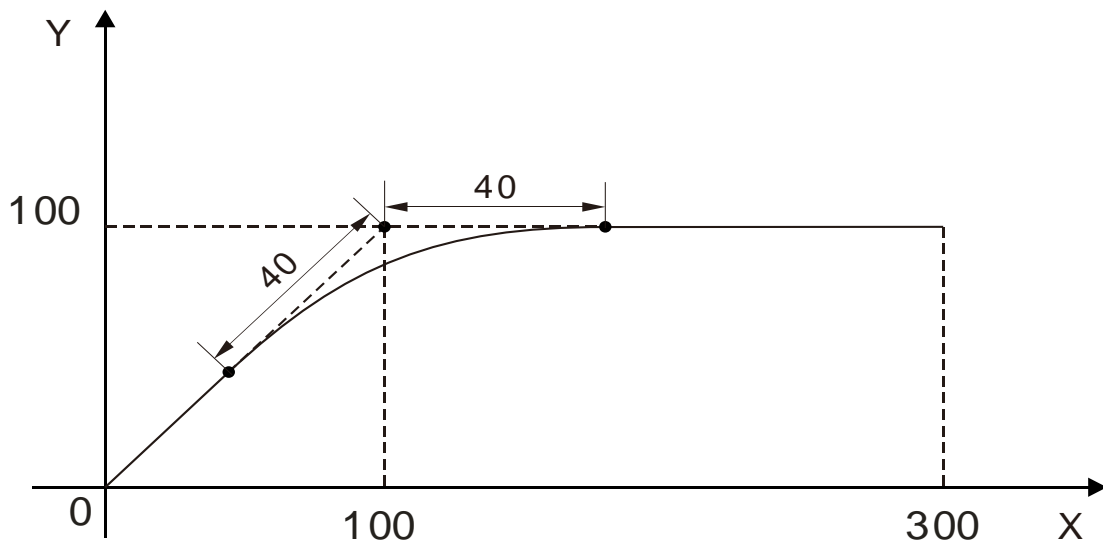

Example 2

```
N0 G1 X100 Y100
N1 G51 D50
N2 G1 X200 Y100
N3 G1 X200 Y0
```

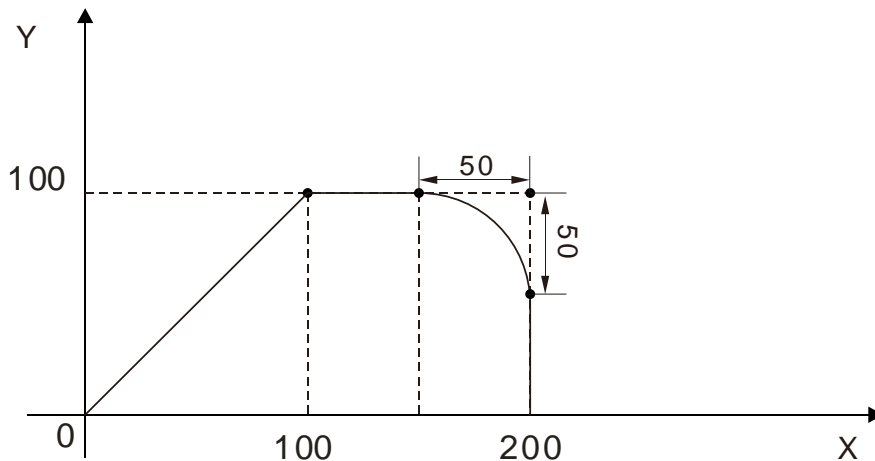

11.6.4.11 G52 (Smooth path transition)

- Function: To change the transition mode into smooth path transition. The following transition modes are always smooth path transition. G50/G51 can be used for the switch of transition modes in the execution process. The terminal actuator will not reduce its speed between G codes. It is suitable for continual interpolation of small segments. In this mode, the speed of the first G code prevails as the entire motion speed and F can not be used for changing the speed in the motion. VelOverride parameter of DMC_CartesianCoordinate instruction can be set to control the speed of terminal actuator.
- Format: N_ G52
- Parameter Explanation:
N_ : The row number of G code in NC program

**Example**

Draw a part of a sin curve.

N0 G52	N1 G1 X0 Y0 E5 E-5 F5
N2 G1 X0.1 Y0.06282151816	N3 G1 X0.2 Y0.1255810391
N4 G1 X0.3 Y0.1882166266	N5 G1 X0.4 Y0.2506664671
N6 G1 X0.5 Y0.3128689301	N7 G1 X0.6 Y0.3747626292
N8 G1 X0.7 Y0.4362864828	N9 G1 X0.8 Y0.4973797743
N10 G1 X0.9 Y0.5579822121	N11 G1 X1 Y0.6180339887
N12 G1 X1.1 Y0.6774758405	N13 G1 X1.2 Y0.7362491054
N14 G1 X1.3 Y0.7942957813	N15 G1 X1.4 Y0.8515585831
N16 G1 X1.5 Y0.9079809995	N17 G1 X1.6 Y0.9635073482
N18 G1 X1.7 Y1.018082832	N19 G1 X1.8 Y1.07165359
N20 G1 X1.9 Y1.124166756	N21 G1 X2 Y1.175570505
N22 G1 X2.1 Y1.225814107	N23 G1 X2.2 Y1.274847979
N24 G1 X2.3 Y1.322623731	N25 G1 X2.4 Y1.369094212
N26 G1 X2.5 Y1.414213562	N27 G1 X2.6 Y1.457937255
N28 G1 X2.7 Y1.500222139	N29 G1 X2.8 Y1.541026486
N30 G1 X2.9 Y1.580310025	N31 G1 X3 Y1.618033989
N32 G1 X3.1 Y1.654161149	N33 G1 X3.2 Y1.688655851
N34 G1 X3.3 Y1.721484054	N35 G1 X3.4 Y1.75261336
N36 G1 X3.5 Y1.782013048	N37 G1 X3.6 Y1.809654105
N38 G1 X3.7 Y1.835509251	N39 G1 X3.8 Y1.859552972
N40 G1 X3.9 Y1.881761538	N41 G1 X4 Y1.902113033
N42 G1 X4.1 Y1.920587371	N43 G1 X4.2 Y1.937166322
N44 G1 X4.3 Y1.951833524	N45 G1 X4.4 Y1.964574501
N46 G1 X4.5 Y1.975376681	N47 G1 X4.6 Y1.984229403
N48 G1 X4.7 Y1.991123929	N49 G1 X4.8 Y1.996053457
N50 G1 X4.9 Y1.999013121	N51 G1 X5 Y2
N52 G1 X5.1 Y1.999013121	N53 G1 X5.2 Y1.996053457
N54 G1 X5.3 Y1.991123929	N55 G1 X5.4 Y1.984229403
N56 G1 X5.5 Y1.975376681	N57 G1 X5.6 Y1.964574501
N58 G1 X5.7 Y1.951833524	N59 G1 X5.8 Y1.937166322
N60 G1 X5.9 Y1.920587371	N61 G1 X6 Y1.902113033
N62 G1 X6.1 Y1.881761538	N63 G1 X6.2 Y1.859552972
N64 G1 X6.3 Y1.835509251	N65 G1 X6.4 Y1.809654105
N66 G1 X6.5 Y1.782013048	N67 G1 X6.6 Y1.75261336
N68 G1 X6.7 Y1.721484054	N69 G1 X6.8 Y1.688655851

N70 G1 X6.9 Y1.654161149	N71 G1 X7 Y1.618033989
N72 G1 X7.1 Y1.580310025	N73 G1 X7.2 Y1.541026486
N74 G1 X7.3 Y1.500222139	N75 G1 X7.4 Y1.457937255
N76 G1 X7.5 Y1.414213562	N77 G1 X7.6 Y1.369094212
N78 G1 X7.7 Y1.322623731	N79 G1 X7.8 Y1.274847979
N80 G1 X7.9 Y1.225814107	N81 G1 X8 Y1.175570505
N82 G1 X8.1 Y1.124166756	N83 G1 X8.2 Y1.07165359
N84 G1 X8.3 Y1.018082832	N85 G1 X8.4 Y0.9635073482
N86 G1 X8.5 Y0.9079809995	N87 G1 X8.6 Y0.8515585831
N88 G1 X8.7 Y0.7942957813	N89 G1 X8.8 Y0.7362491054
N90 G1 X8.9 Y0.6774758405	N91 G1 X9 Y0.6180339887
N92 G1 X9.1 Y0.5579822121	N93 G1 X9.2 Y0.4973797743
N94 G1 X9.3 Y0.4362864828	N95 G1 X9.4 Y0.3747626292
N96 G1 X9.5 Y0.3128689301	N97 G1 X9.6 Y0.2506664671
N98 G1 X9.7 Y0.1882166266	N99 G1 X9.8 Y0.1255810391
N100 G1 X9.9 Y0.06282151816	N101 G1 X10 Y0

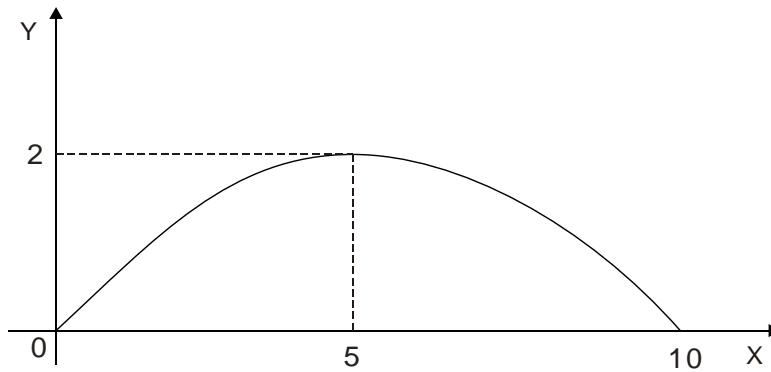

11.6.4.12 M Code

- Function: Interacts with general programs.
- Format: N_ M_ D_
- Parameter Explanation:
 - N_ : The row number of M code in NC program
 - M_ : The number of M code, range: 0~99
 - D_ : Output parameter, data type: LREAL.
- Instruction Explanation:
 1. D_ can be omitted and then no parameter is output after M code is executed.
 2. Two methods of using M code: one is to write it outside the row of G code; the other is to write it in the row of G code.
 3. When M code and G code are not in the same row, e.g. N0 M10 D10.02 ; N1 G1 X100 Y100. When arriving at the row N0, G code execution will stop. Meanwhile, DMC_ReadMFunction is used to read the state of M code, MFunction is TRUE and the value of MFunctionValue is 10.02. After M code is reset by using DMC_ResetMFunction instruction, G code execution will continue and then N1 row will be executed.
 4. When M code and G code are in the same row and M code can only be placed after G code, e.g. N0 G1 X100 M10 D10.02. When the execution arrives at N0 row, G1 is executed. Meanwhile, DMC_ReadMFunction is used to read the state of M code, MFunction is TRUE and the value of MFunctionValue is 10.02. The following execution will continue after G1 execution is finished and reset instruction will no be needed to reset M code.



Example

```
N0 G1 X100 Y50
N1 M20
N2 G1 X200 Y50 M21 D3.14
N3 G1 X300 Y150
```

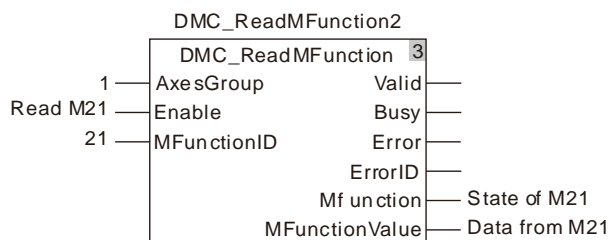
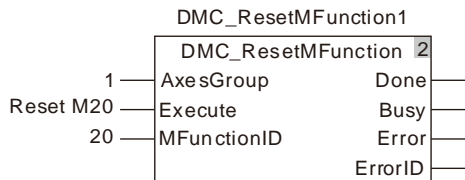
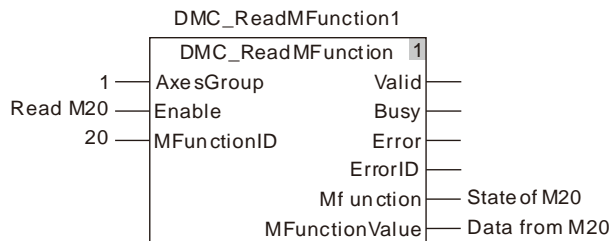

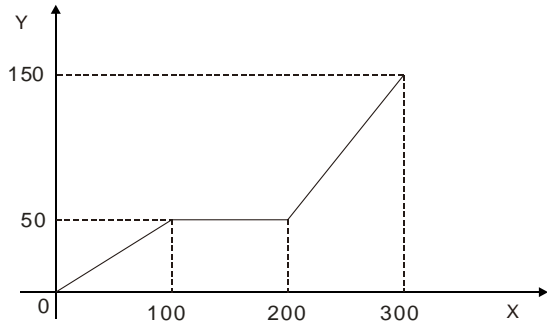

When the two variables “Read M20” and “Read M21” are TRUE, G code execution starts and the terminal actuator stops at the position (100 · 50). At the moment, the variable “State of M20” is TRUE. After the execution of other actions is finished, the variable “Reset M20” changes to TRUE and M code is reset. Then G code execution continues. The terminal actuator starts to move to (200, 50). Meanwhile, the variable “state of M21” changes to TRUE and the value of “Data from M21” variable is 3.14. The terminal actuator will not stop at that time. After reaching the position (200, 50), it will keep moving till the poition (300, 150) is reached and the execution is completed.

11.6.5 G Code Instruction

11.6.5.1 DMC_CartesianCoordinate

FB/FC	Explanation	Applicable model
FB	DMC_CartesianCoordinate is used for controlling the Cartesian-coordinate robotic arm to make the interpolation in accordance with G code.	DVP15MC11T DVP15MC11T-06

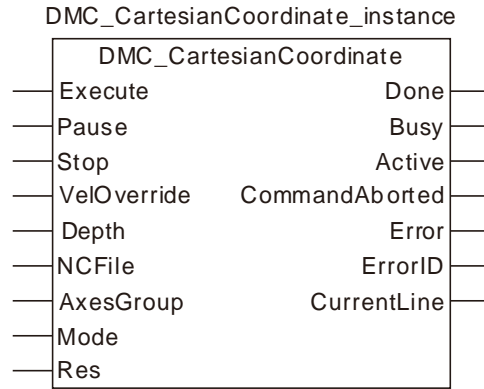

● **Input Parameters**

Parameter name	Function	Data type	Valid range (Default)	Validation timing
Execute	The instruction is executed when <i>Execute</i> changes from FALSE to TRUE.	BOOL	TRUE or FALSE (FALSE)	-
Pause	When <i>Pause</i> changes from FALSE to TRUE, the Cartesian-coordinate robotic arm stops executing G code temporarily.	BOOL	TRUE or FALSE (FALSE)	
Stop	When <i>Stop</i> changes from FALSE to TRUE, the Cartesian-coordinate robotic arm terminates the executio of G code.	BOOL	TRUE or FALSE (FALSE)	
VelOverride	Velocity override (%)	LREAL	0~500 (0)	When <i>Execute</i> changes from FALSE to TRUE.
Depth	Fill 1 for internal reservation	UINT	1	When <i>Execute</i> changes from FALSE to TRUE.
NCFile	The number of the NC file	UINT	1~64 (The variable value must be set)	When <i>Execute</i> changes from FALSE to TRUE.
AxesGroup	The number of the axes group	USINT	1~8 (The variable value must be set)	When <i>Execute</i> changes from FALSE to TRUE.
Mode	Fill 0 for internal reservation	INT	0	When <i>Execute</i> changes from FALSE to TRUE.
Res	Reserved			

● **Output Parameters**

Parameter name	Function	Data type	Valid range
Done	TRUE when the instruction execution is completed.	BOOL	TRUE / FALSE
Busy	TRUE when the instruction is being executed.	BOOL	TRUE / FALSE
Active	TRUE when the axis is under control of the instruction.	BOOL	TRUE / FALSE
CommandAborted	TRUE when the instruction execution is aborted.	BOOL	TRUE / FALSE
Error	TRUE when an error occurs in execution of the instruction.	BOOL	TRUE / FALSE
ErrorID	Contains the error code when an error occurs. Please refer to section 12.2.	WORD	
CurrentLine	The number of the row where the G code is being executed currently.	UDINT	

● **Output Update Timing**

Name	Timing for changing to TRUE	Timing for changing to FALSE
Done	◆ When the G code execution is finished.	◆ When <i>Execute</i> changes from TRUE to FALSE after the instruction execution is done. ◆ <i>Done</i> changes to TRUE when the instruction execution is completed after <i>Execute</i> changes from TRUE to FALSE during the instruction execution. One period later, <i>Done</i> changes to FALSE.
Busy	◆ When <i>Execute</i> changes to TRUE	◆ When <i>Done</i> changes to TRUE ◆ When <i>Error</i> changes to TRUE ◆ When <i>CommandAbort</i> changes to TRUE
Active	◆ TRUE when the instruction is controlling axes.	◆ When <i>Done</i> changes to TRUE ◆ When <i>Error</i> changes to TRUE ◆ When <i>CommandAbort</i> changes to TRUE
CommandAborted	◆ TRUE when the instruction execution is aborted by other instruction.	◆ When <i>Execute</i> changes from TRUE to FALSE ◆ <i>CommandAborted</i> changes to TRUE when the instruction execution is aborted by other instruction after <i>Execute</i> changes from TRUE to FALSE during the instruction execution. One period later, <i>CommandAborted</i> changes to FALSE.
Error	◆ The input parameters for the instruction are illegal or an error occurs in the instruction execution.	◆ When <i>Execute</i> changes from TRUE to FALSE

● **Output Update Timing Chart**

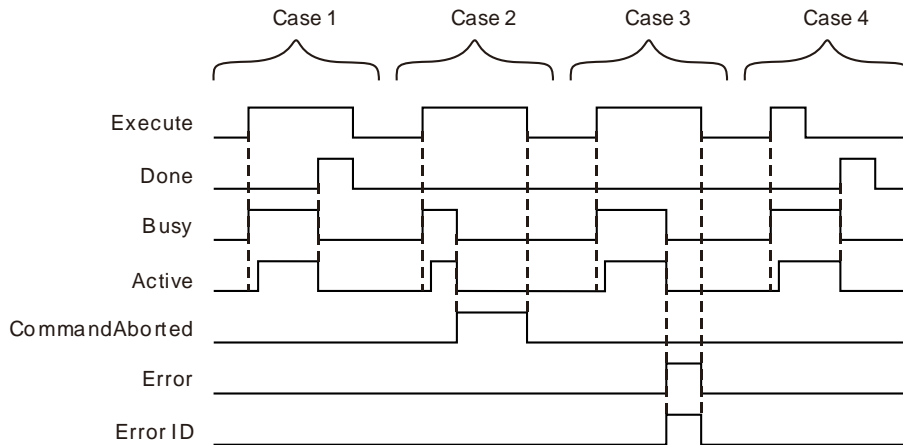

Case 1 : When *Execute* changes from FALSE to TRUE, *Busy* changes to TRUE and one cycle later, *Active* changes to TRUE. When positioning is done, *Done* changes to TRUE. Meanwhile *Busy* and *Active* change to FALSE.

Case 2 : If the instruction is aborted by MC_Stop or MC_Halt after *Execute* changes from FALSE to TRUE, *CommandAborted* changes to TRUE and meanwhile *Busy* and *Active* change to FALSE. When *Execute* changes from TRUE to FALSE, *CommandAborted* changes to FALSE.

Case 3 : When an error occurs after *Execute* changes from FALSE to TRUE, *Error* changes to TRUE and *ErrorID* shows corresponding error code. Meanwhile, *Busy* and *Active* change to FALSE. *Error* changes to FALSE when *Execute* changes from TRUE to FALSE.

Case 4 : When the instruction execution is finished after *Execute* changes from TRUE to FALSE during the instruction execution, *Done* changes to TRUE and meanwhile, *Busy* and *Active* change to FALSE. One cycle later, *Done* changes to FALSE.

● **Function**

DMC_CartesianCoordinate instruction is used for controlling the Cartesian-coordinate robotic arm to make the interpolation in accordance with G code. It is applied to the engraving machine and sewing machine which regard the Cartesian coordinate robot as mathematical model. The firmware of V1.01 and above supports the function.

1. *Pause* is used for temporarily stopping the execution of G code. After *Pause* is set to TRUE, the terminal actuator will reduce its velocity to 0 according to the specified deceleration rate. When pausing is finished, *Pause* is set to FALSE. The terminal actuator will speed up at the specified acceleration rate till the target velocity is reached and the G code interpolation will continue.
2. *Stop* is used to terminate the execution of G code. Once *Stop* is set to TRUE, the terminal actuator will stop immediately and meanwhile *Done* of the instruction changes to TRUE and the G code execution is terminated.
3. *VelOverride* is used for changing the velocity of the terminal actuator ranging from 0~500 with the unit: %. "100" means "100%". The velocity of the terminal actuator after modification= The velocity of the terminal actuator before modification x override value.
The axis will accelerate or decelerate till the target velocity after modification is reached according to the acceleration rate and deceleration rate of the G code which is being executed currently.
4. *NCFile* is used to specify the NC file number for execution. The number is the ID of the CNC file built in the programming software.
5. *AxesGroup* is to specify the number of the axes group which is to perform G code.
6. Before using the DMC_CartesianCoordinate instruction, the axes in the axes group must be in standstill. Otherwise, there will be an error in the instruction execution.

7. Before the instruction controls axes motion, axes should be adjusted with single-axis instructions to the position where G code execution starts first. Then DMC_AddAxisToGroup is used to add individual axes to the axes group. Afterwards, DMC_SetG0Para and DMC_SetG1Para are used to set relevant parameters of G0 and G1/G2/G3. Finally the DMC_CartesianCoordinate instruction is executed to control axes for interpolation along the path planned via G codes.



Programming Example

1. The variable table and program

Variable name	Data type	Initial value
Pwr	MC_Power	
Axis1	USINT	1
Pwr_En	BOOL	FALSE
Pwr_BM	MC_Buffer_Mode	0
Pwr_Sta	BOOL	
Pwr_Bsy	BOOL	
Pwr_Act	BOOL	
Pwr_Err	BOOL	
Pwr_ErrID	WORD	
Pwr1	MC_Power	
Axis2	USINT	2
Pwr1_BM	MC_Buffer_Mode	0
Pwr1_Sta	BOOL	
Pwr1_Bsy	BOOL	
Pwr1_Act	BOOL	
Pwr1_Err	BOOL	
Pwr1_ErrID	WORD	
ATG	DMC_AddAxisToGroup	
Axes1	USINT	1
ATG_Ex	BOOL	FALSE
ATG_Done	BOOL	
ATG_Bsy	BOOL	
ATG_Err	BOOL	
ATG_ErrID	WORD	
ATG1	DMC_AddAxisToGroup	
ATG1_Ex	BOOL	FALSE
ATG1_Done	BOOL	
ATG1_Bsy	BOOL	
ATG1_Err	BOOL	
ATG1_ErrID	WORD	
SG1	DMC_SetG1Para	
SG1_AG	USINT	1
SG1_Ex	BOOL	FALSE
SG1_Vel	LREAL	10000
SG1_Acc	LREAL	5000
SG1_Dec	LREAL	5000
SG1_Jer	LREAL	5000
SG1_Done	BOOL	

Variable name	Data type	Initial value
SG1_Bsy	BOOL	
SG1_Err	BOOL	
SG1_ErrID	WORD	
CC	DMC_CartesianCoordinate	
CC_Ex	BOOL	FALSE
CC_Pa	BOOL	FALSE
CC_St	BOOL	FALSE
CC_Done	BOOL	
CC_Bsy	BOOL	
CC_Act	BOOL	
CC_Abt	BOOL	
CC_Err	BOOL	
CC_ErrID	WORD	
CC_CL	UDINT	

G code:

N0 G1 X1000 Y1000

N1 G1 X5200 Y3500

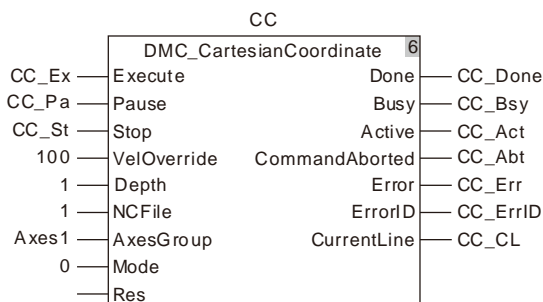
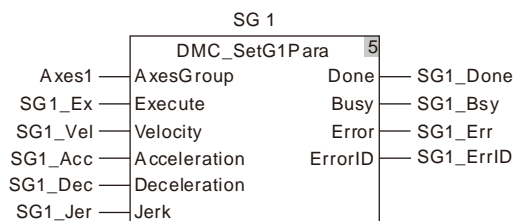
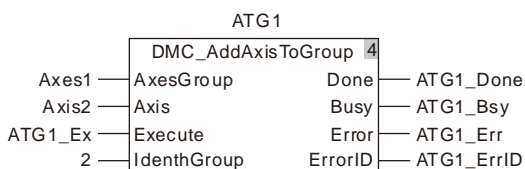
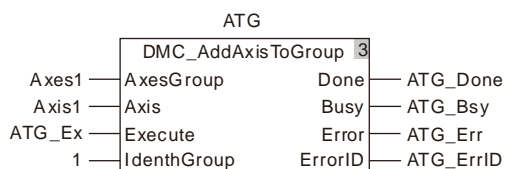
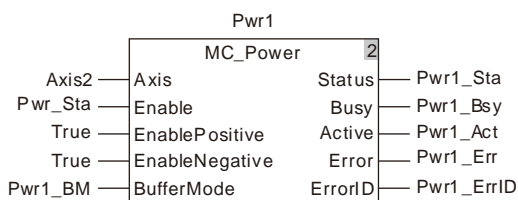
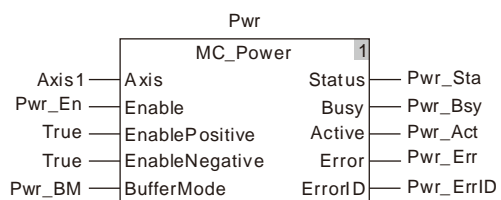

2. Motion Curve

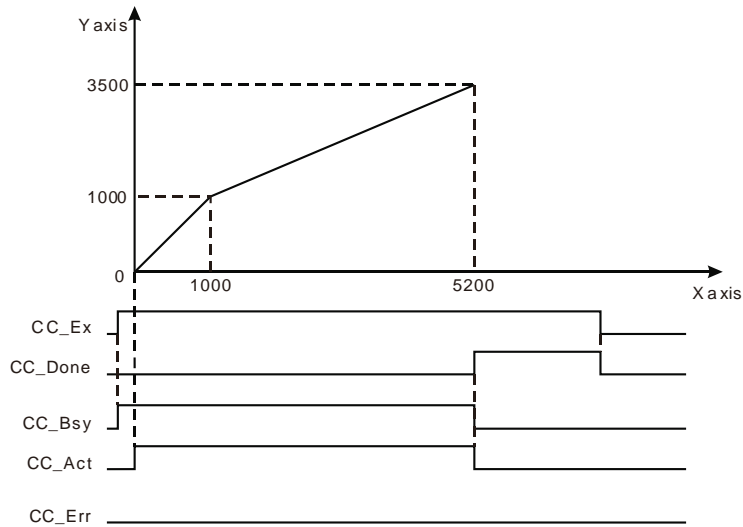

- ❖ When Pwr_En is set to TRUE, MC_Power instruction is executed to enable two axes. Then ATG_Ex and ATG1_Ex are set to TRUE and DMC_AddAxisToGroup instruction is executed to add Axis1 and Axis2 to the axes group Axes1. Afterwards, set SG1_Ex to TRUE to execute DMC_SetG1Para instruction and set the default velocity of G1/G2/G3. At last, CC_Ex is set to TRUE and DMC_CartesianCoordinate instruction is executed to control axis 1 and axis 2 for the interpolation based on the path planned via G codes.
- ❖ When CC_Ex changes from FALSE to TRUE, DMC_CartesianCoordinate instruction is executed. In the same cycle, CC_Bsy changes from FALSE to TRUE. In the second cycle, CC_Act changes from FALSE to TRUE, the robot will move according to the path planned via G code. After G code execution is completed, the output CC_Done changes from FALSE to TRUE and meanwhile CC_Bsy and CC_Act change from TRUE to FALSE.
- ❖ When CC_Ex changes from TRUE to FALSE, CC_Done changes from TRUE to FALSE.

11.6.5.2 DMC_ReadMFunction

FB/FC	Explanation	Applicable model
FB	DMC_ReadMFunction is used for ResetMFunction	DVP15MC11T DVP15MC11T-06

11

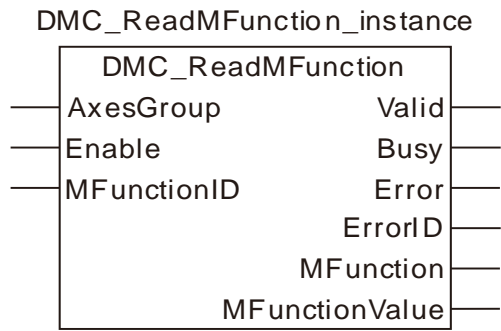

● **Input Parameters**

Parameter name	Function	Data type	Valid range (Default)	Validation timing
AxesGroup	The number of the axes group	USINT	1~8 (The variable value must be set)	When <i>Enable</i> changes to TRUE
Enable	The instruction is executed when <i>Enable</i> changes from FALSE to TRUE.	BOOL	TRUE or FALSE (FALSE)	-
MFunctionID	The number of a M code	USINT	0~99 (The variable value must be set)	When <i>Enable</i> changes to TRUE

● **Output Parameters**

Parameter name	Function	Data type	Valid range
Valid	TRUE when the output of the instruction is valid.	BOOL	TRUE / FALSE
Busy	TRUE when the instruction is being executed.	BOOL	TRUE / FALSE
Error	TRUE when an error occurs in execution of the instruction.	BOOL	TRUE / FALSE
ErrorID	Contains the error code when an error occurs. Please refer to section 12.2.	WORD	-
MFunction	TRUE when the M code is reached during G code execution.	BOOL	TRUE / FALSE
MFunctionValue	The value of M code parameter is output here when the output <i>MFunction</i> is TRUE.	LREAL	

● **Output Update Timing**

Name	Timing for changing to TRUE	Timing for changing to FALSE
Valid	◆ When the instruction reads the state of M code.	◆ When <i>Enable</i> changes from TRUE to FALSE.
Busy	◆ When <i>Enable</i> changes to TRUE.	◆ When <i>Valid</i> changes to TRUE ◆ When <i>Error</i> changes to TRUE
Error	◆ When an input parameter is illegal or an error occurs during the instruction execution.	◆ When <i>Enable</i> changes from TRUE to FALSE

● **Output Update Timing Chart**

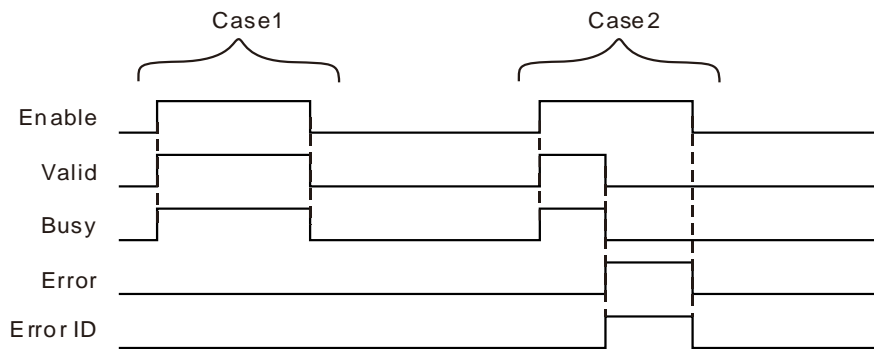

Case 1 : When *Enable* changes from FALSE to TRUE, *Valid* and *Busy* change to TRUE simultaneously. When *Enable* changes to FALSE, *Valid* and *Busy* both change to FALSE.

Case 2 : When an error occurs, *Error* changes to TRUE and *ErrorID* shows corresponding error codes. Meanwhile *Busy* and *Valid* change to FALSE. When *Enable* changes from TRUE to FALSE, *Error* changes to FALSE and the value in *ErrorID* is cleared.

● Function

DMC_ReadMFunction is used for reading the state of M code and the data from it. When the G code execution reaches where the M code set by the instruction is, *MFunction* changes to TRUE and meanwhile *MFunctionValue* outputs the parameter value after M code. The firmware of V1.01 and above supports the function.



Programming Example

1. The variable table and program

Variable name	Data type	Initial value
RMF	DMC_ReadMFunction	
Axes1	USINT	1
RMF_En	BOOL	FALSE
RMF_MID	USINT	0
RMF_Va	BOOL	
RMF_Bsy	BOOL	
RMF_Err	BOOL	
RMF_ErrID	WORD	
RMF_MF	BOOL	
RMF_MFV	LREAL	

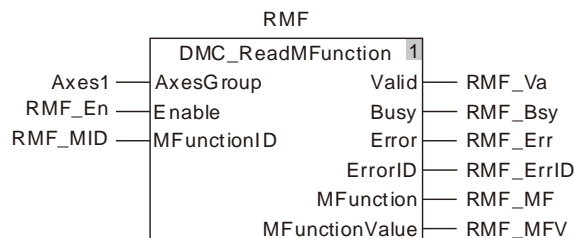

2. Timing Chart

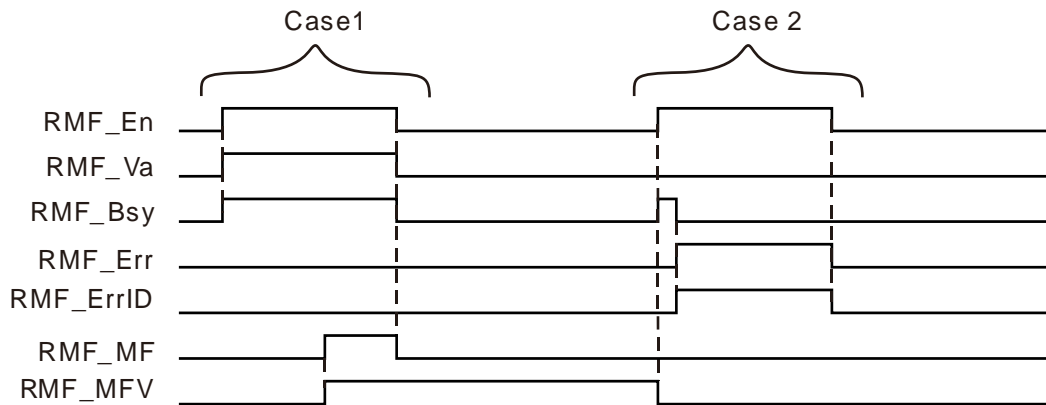

- ❖ When RMF_En changes from FALSE to TRUE and DMC_ReadMFunction instruction is executed, RMF_Va and RMF_Bsy change from FALSE to TRUE in the first cycle. When G code execution reaches where the set M code is, RMF_MF changes from FALSE to TRUE and meanwhile RMF_MFV outputs M code parameter value. When RMF_En changes from TRUE to FALSE, RMF_Va, RMF_Bsy and RMF_MF change from TRUE to FALSE in the same cycle and the M code parameter value of RMF_MFV is not cleared.
- ❖ When RMF_En changes from FALSE to TRUE, an error in the instruction parameter input occurs, RMF_Bsy changes from FALSE to TRUE in the first cycle and the M code parameter value which was executed last time is cleared. In the second cycle, RMF_Err changes from FALSE to TRUE, meanwhile RMF_Bsy changes from TRUE to FALSE and RMF_ErrID outputs corresponding error codes. When RMF_En changes from TRUE to FALSE, RMF_Err changes from TRUE to FALSE and meanwhile the value in RMF_ErrID is cleared.

11.6.5.3 DMC_ResetMFunction

FB/FC	Explanation	Applicable model
FB	DMC_ResetMFunction instruction resets the state of M code.	DVP15MC11T DVP15MC11T-06

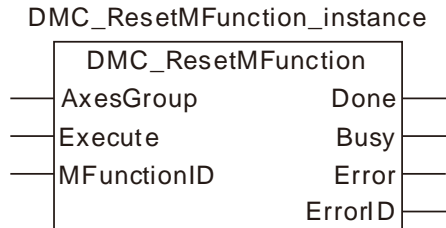

● Input Parameters

Parameter name	Function	Data type	Valid range (Default)	Validation timing
AxesGroup	The number of the axes group	USINT	1~8 (The variable value must be set)	When <i>Execute</i> changes from FALSE to TRUE.
Execute	The instruction is executed when <i>Execute</i> changes from FALSE to TRUE.	BOOL	TRUE or FALSE (FALSE)	-
MFunctionID	The number of the M code	USINT	0~99 (The variable value must be set)	When <i>Execute</i> changes from FALSE to TRUE.

● Output Parameters

Parameter name	Function	Data type	Valid range
Done	TRUE when the instruction execution is completed.	BOOL	TRUE / FALSE
Busy	TRUE when the instruction is being executed.	BOOL	TRUE / FALSE
Error	TRUE when an error occurs in execution of the instruction.	BOOL	TRUE / FALSE
ErrorID	Contains the error code when an error occurs. Please refer to section 12.2.	WORD	-

● Output Update Timing

Name	Timing for changing to TRUE	Timing for changing to FALSE
Done	◆ When resetting M code is finished.	◆ When <i>Execute</i> changes from TRUE to FALSE after the instruction execution is completed.
Busy	◆ When <i>Execute</i> changes to TRUE.	◆ When <i>Done</i> changes to TRUE ◆ When <i>Error</i> changes to TRUE
Error	◆ When an input parameter is illegal or an error occurs during the instruction execution.	◆ When <i>Execute</i> changes from TRUE to FALSE

● **Output Update Timing Chart**

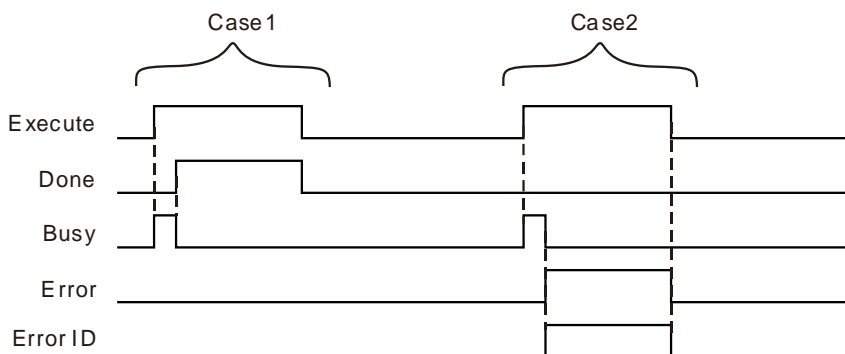

Case 1 : When *Execute* changes from FALSE to TRUE, *Busy* changes to TRUE and one cycle later, *Done* changes to TRUE and *Busy* changes to FALSE.

Case 2 : When an error occurs during the instruction execution, *Error* changes to TRUE and *ErrorID* shows corresponding error code. Meanwhile, *Busy* changes to FALSE. *Error* changes to FALSE when *Execute* changes from TRUE to FALSE.

● **Function**

DMC_ResetMFunction instruction resets the state of M code. When G code execution reaches where M code set by the intruction is, the output state of M code is TRUE and DMC_ResetMFunction instruction is executed. The output state of M code is reset to FALSE and G code execution will continue. The firmware of V1.01 and above supports the function.



Programming Example

1. The variable table and program

Variable name	Data type	Initial value
RMF	DMC_ReadMFunction	
Axes1	USINT	1
RMF_En	BOOL	FALSE
RMF_MID	USINT	0
RMF_Va	BOOL	
RMF_Bsy	BOOL	
RMF_Err	BOOL	
RMF_ErrID	WORD	
RMF_MF	BOOL	
RMF_MFV	LREAL	
REM	DMC_ResetMFunction	
REM_Ex	BOOL	FALSE
REM_MID	USINT	0
REM_Done	BOOL	
REM_Bsy	BOOL	
REM_Err	BOOL	
REM_ErrID	WORD	

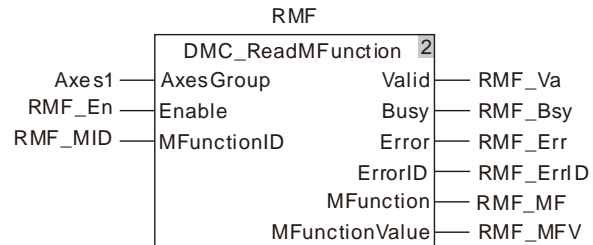
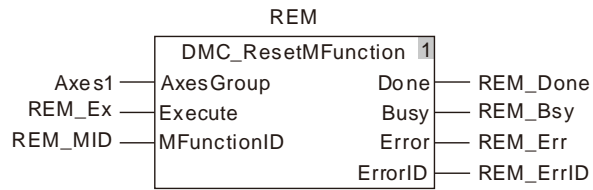

2. Timing Chart

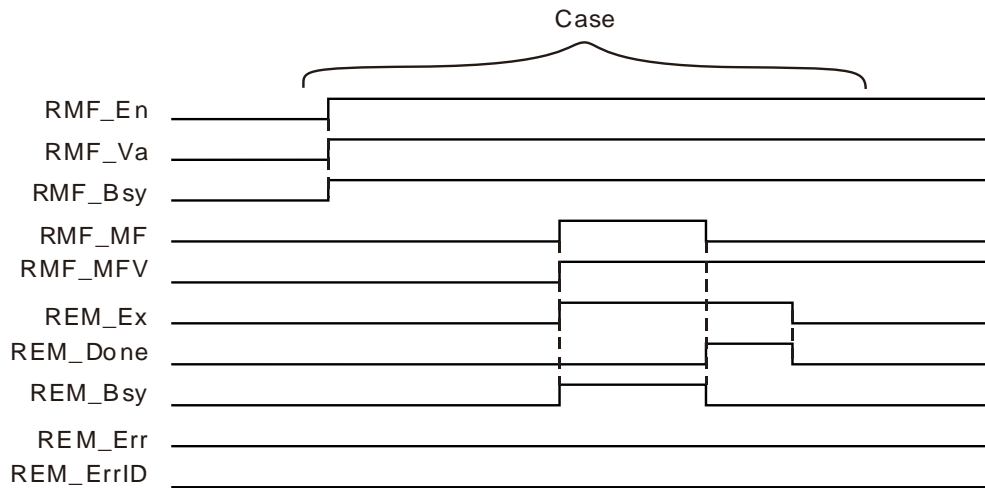

- ❖ When RMF_En changes from FALSE to TRUE, DMC_ReadMFunction instruction is executed. In the same cycle, RMF_Va and RMF_Bsy change from FALSE to TRUE. When G code execution reaches where the set M code is, RMF_MF changes from FALSE to TRUE and meanwhile RMF_MFV outputs M code parameter value.
- ❖ When REM_Ex changes from FALSE to TRUE, DMC_ResetMFunction instruction is executed. In the same cycle, REM_Bsy changes from FALSE to TRUE. In the second cycle, REM_Done changes from FALSE to TRUE. Meanwhile the output RMF_MF of DMC_ReadMFunction changes from TRUE to FALSE and REM_Bsy changes from TRUE to FALSE. When REM_Ex changes from TRUE to FALSE, REM_Done changes from TRUE to FALSE in the same cycle.

11.6.5.4 DMC_SetG0Para

FB/FC	Explanation	Applicable model
FB	DMC_SetG0Para is used for setting the velocity, acceleration, deceleration and jerk of G0.	DVP15MC11T DVP15MC11T-06

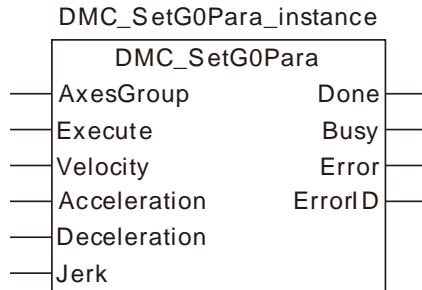

● Input Parameters

Parameter name	Function	Data type	Valid range (Default)	Validation timing
AxesGroup	The number of the axes group	USINT	1~8 (The variable value must be set)	When <i>Execute</i> changes from FALSE to TRUE.
Execute	The instruction is executed when <i>Execute</i> changes from FALSE to TRUE.	BOOL	TRUE or FALSE (FALSE)	-
Velocity	Specify the target speed (Unit: unit/second)	ARRAY [1..8] OF LREAL	Positive number (The variable value must be set)	When <i>Execute</i> changes from FALSE to TRUE.
Acceleration	Specify the target acceleration rate. (Unit: Unit/s ²)	ARRAY [1..8] OF LREAL	Positive number (The variable value must be set)	When <i>Execute</i> changes from FALSE to TRUE.
Deceleration	Specify the target deceleration rate. (Unit: Unit/s ²)	ARRAY [1..8] OF LREAL	Positive number (The variable value must be set)	When <i>Execute</i> changes from FALSE to TRUE.
Jerk	Specify the target jerk. (Unit: Unit/s ³)	ARRAY [1..8] OF LREAL	Positive number (The variable value must be set)	When <i>Execute</i> changes from FALSE to TRUE.

● Output Parameters

Parameter name	Function	Data type	Valid range
Done	TRUE when the instruction execution is completed.	BOOL	TRUE / FALSE
Busy	TRUE when the instruction is being executed.	BOOL	TRUE / FALSE
Error	TRUE when an error occurs in execution of the instruction.	BOOL	TRUE / FALSE
ErrorID	Contains the error code when an error occurs. Please refer to section 12.2.	WORD	-

● Output Update Timing

Name	Timing for changing to TRUE	Timing for changing to FALSE
Done	◆ When the setting is completed.	◆ When <i>Execute</i> changes from TRUE to FALSE after the instruction execution is completed.
Busy	◆ When <i>Execute</i> changes to TRUE.	◆ When <i>Done</i> changes to TRUE ◆ When <i>Error</i> changes to TRUE

Name	Timing for changing to TRUE	Timing for changing to FALSE
Error	◆ When an input parameter is illegal or an error occurs during the instruction execution.	◆ When <i>Execute</i> changes from TRUE to FALSE

● Output Update Timing Chart

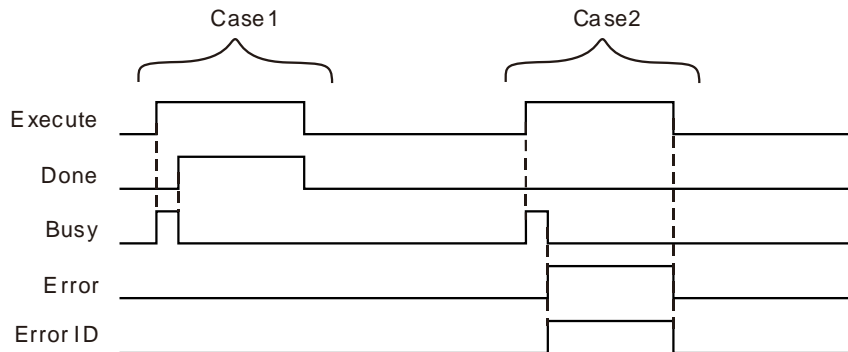

Case 1 : When *Execute* changes from FALSE to TRUE, *Busy* changes to TRUE and one cycle later, *Done* changes to TRUE and meanwhile *Busy* changes to FALSE.

Case 2 : When an error occurs during the instruction execution, *Error* changes to TRUE and *ErrorID* shows corresponding error code. Meanwhile, *Busy* changes to FALSE. *Error* changes to FALSE when *Execute* changes from TRUE to FALSE.

● Function

DMC_SetG0Para is used for setting the velocity, acceleration, deceleration and jerk of G0. When G0 of G codes is executed, the velocity, acceleration, deceleration and jerk will be performed according to the parameters set by DMC_SetG0Para instruction. The firmware of V1.01 and above supports the function.



Programming Example

1. The variable table and program

Variable name	Data type	Initial value
SG0	DMC_SetG0Para	
Axes1	USINT	1
SG0_Ex	BOOL	FALSE
SG0_Vel	ARRAY[1..8]OF LREAL	
SG0_Acc	ARRAY[1..8]OF LREAL	
SG0_Dec	ARRAY[1..8]OF LREAL	
SG0_Jer	ARRAY[1..8]OF LREAL	
SG0_Done	BOOL	
SG0_Bsy	BOOL	
SG0_Err	BOOL	
SG0_ErrID	WORD	

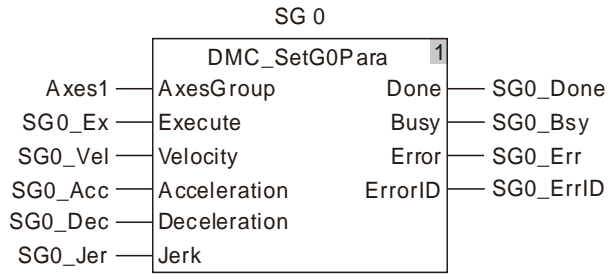

2. Timing Chart

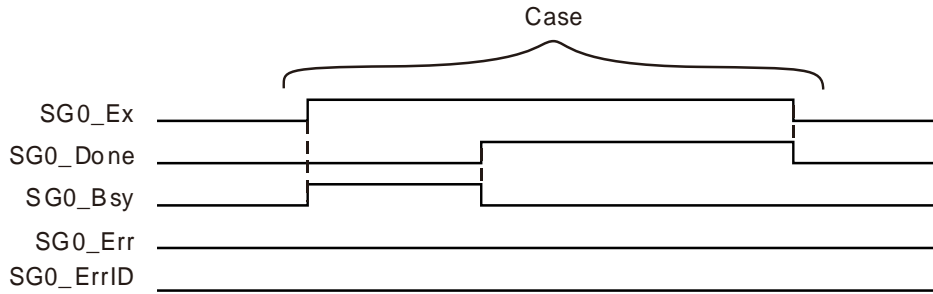

- ❖ When SG0_Ex changes from FALSE to TRUE, DMC_SetG0Para instruction is executed. In the same cycle, SG0_Bsy changes from FALSE to TRUE. In the second cycle, SG0_Done changes from FALSE to TRUE and meanwhile SG0_Bsy changes from TRUE to FALSE. So G0 among G codes will be executed according to the velocity, acceleration, deceleration and jerk which are set by the instruction.
- ❖ When SG0_Ex changes from TRUE to FALSE, SG0_Done changes from TRUE to FALSE.

11.6.5.5 DMC_SetG1Para

FB/FC	Explanation	Applicable model
FB	DMC_SetG1Para instruction sets the default velocity, acceleration, deceleration and jerk for G1/G2/G3.	DVP15MC11T DVP15MC11T-06

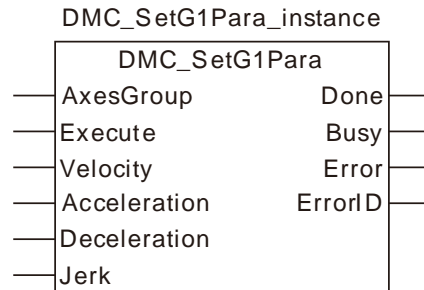

● Input Parameters

Parameter name	Function	Data type	Valid range (Default)	Validation timing
AxesGroup	The number of the axes group	USINT	1~8 (The variable value must be set)	When <i>Execute</i> changes from FALSE to TRUE.
Execute	The instruction is executed when <i>Execute</i> changes from FALSE to TRUE.	BOOL	TRUE or FALSE (FALSE)	-
Velocity	Specify the target speed (Unit: unit/second)	LREAL	Positive number (The variable value must be set)	When <i>Execute</i> changes from FALSE to TRUE.
Acceleration	Specify the target acceleration rate. (Unit: Unit/s ²)	LREAL	Positive number (The variable value must be set)	When <i>Execute</i> changes from FALSE to TRUE.
Deceleration	Specify the target deceleration rate. (Unit: Unit/s ²)	LREAL	Positive number (The variable value must be set)	When <i>Execute</i> changes from FALSE to TRUE.
Jerk	Specify the target jerk. (Unit: Unit/s ³)	LREAL	Positive number (The variable value must be set)	When <i>Execute</i> changes from FALSE to TRUE.

● Output Parameters

Parameter name	Function	Data type	Valid range
Done	TRUE when the instruction execution is completed.	BOOL	TRUE / FALSE
Busy	TRUE when the instruction is being executed.	BOOL	TRUE / FALSE
Error	TRUE when an error occurs in execution of the instruction.	BOOL	TRUE / FALSE
ErrorID	Contains the error code when an error occurs. Please refer to section 12.2.	WORD	-

● Output Update Timing

Name	Timing for changing to TRUE	Timing for changing to FALSE
Done	◆ When the setting is completed.	◆ When <i>Execute</i> changes from TRUE to FALSE after the instruction execution is completed.
Busy	◆ When <i>Execute</i> changes to TRUE.	◆ When <i>Done</i> changes to TRUE ◆ When <i>Error</i> changes to TRUE

Name	Timing for changing to TRUE	Timing for changing to FALSE
Error	◆ When an input parameter is illegal or an error occurs during the instruction execution.	◆ When <i>Execute</i> changes from TRUE to FALSE

● **Output Update Timing Chart**

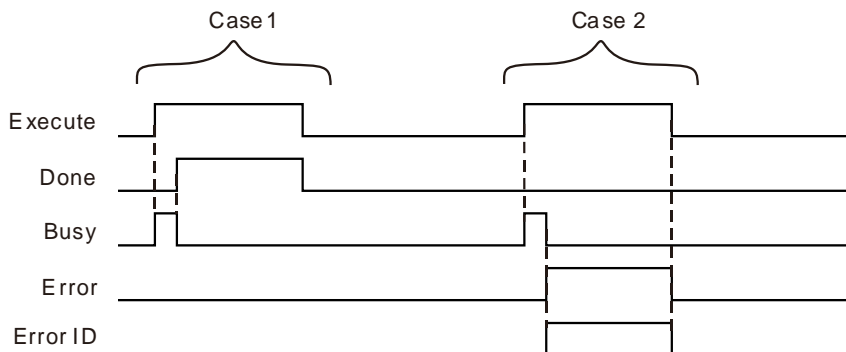

Case 1 : When *Execute* changes from FALSE to TRUE, *Busy* changes to TRUE and one cycle later, *Done* changes to TRUE and *Busy* changes to FALSE.

Case 2 : When an error occurs during the instruction execution, *Error* changes to TRUE and *ErrorID* shows corresponding error code. Meanwhile, *Busy* changes to FALSE. *Error* changes to FALSE when *Execute* changes from TRUE to FALSE.

● **Function**

DMC_SetG1Para instruction sets the default velocity, acceleration, deceleration and jerk for G1/G2/G3. When G codes execution reaches G1/G2/G3, G1/G2/G3 will be performed according to the velocity, acceleration and deceleration set by the instruction if E and F values are not specified. Otherwise, they will run based on the filled E and F values in G codes. The firmware of V1.01 and above supports the function.



Programming Example

1. **The variable table and program**

Variable name	Data type	Initial value
SG1	DMC_SetG1Para	
Axes1	USINT	1
SG1_Ex	BOOL	FALSE
SG1_Vel	LREAL	5000
SG1_Acc	LREAL	1000
SG1_Dec	LREAL	1000
SG1_Jer	LREAL	1000
SG1_Done	BOOL	
SG1_Bsy	BOOL	
SG1_Err	BOOL	
SG1_ErrID	WORD	

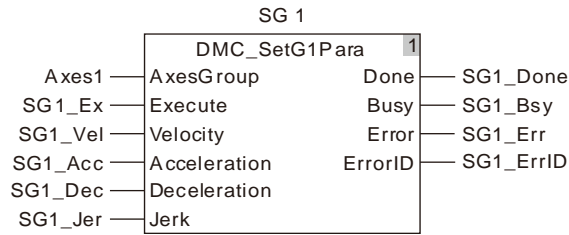

2. Timing Chart

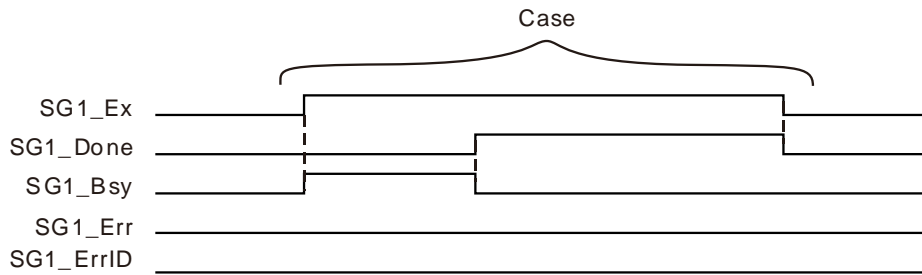

- ❖ When SG1_Ex changes from FALSE to TRUE, DMC_SetG1Para instruction is executed. In the same cycle, SG1_Bsy changes from FALSE to TRUE. In the second cycle, SG1_Done changes from FALSE to TRUE and meanwhile SG1_Bsy changes from TRUE to FALSE. So G1 among G codes will be executed according to the velocity, acceleration, deceleration and jerk which are set by the instruction.
- ❖ When SG1_Ex changes from TRUE to FALSE, SG1_Done changes from TRUE to FALSE.

11.6.5.6 DMC_SetStartPosition

FB/FC	Explanation	Applicable model
FB	DMC_SetStartPosition instruction sets the start positions of axes of G code.	DVP15MC11T DVP15MC11T-06

11

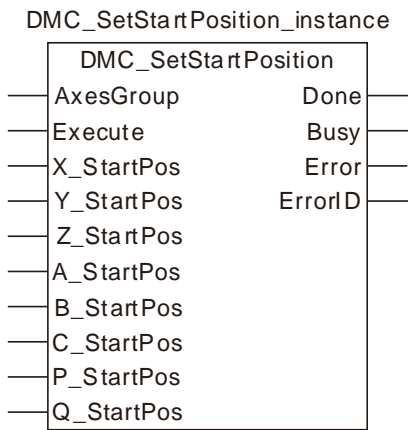

● Input Parameters

Parameter name	Function	Data type	Valid range (Default)	Validation timing
AxesGroup	The number of the axes group	USINT	1~8 (The variable value must be set)	When <i>Execute</i> changes from FALSE to TRUE.
Execute	The instruction is executed when <i>Execute</i> changes from FALSE to TRUE.	BOOL	TRUE or FALSE (FALSE)	-
X_StartPos	Specify the start position of X axis.	LREAL	Positive number, 0, negative number (0)	When <i>Execute</i> changes from FALSE to TRUE.
Y_StartPos	Specify the start position of Y axis.	LREAL	Positive number, 0, negative number (0)	When <i>Execute</i> changes from FALSE to TRUE.
Z_StartPos	Specify the start position of Z axis.	LREAL	Positive number, 0, negative number (0)	When <i>Execute</i> changes from FALSE to TRUE.
A_StartPos	Specify the start position of A axis.	LREAL	Positive number, 0, negative number (0)	When <i>Execute</i> changes from FALSE to TRUE.
B_StartPos	Specify the start position of B axis.	LREAL	Positive number, 0, negative number (0)	When <i>Execute</i> changes from FALSE to TRUE.
C_StartPos	Specify the start position of C axis.	LREAL	Positive number, 0, negative number (0)	When <i>Execute</i> changes from FALSE to TRUE.
P_StartPos	Specify the start position of P axis.	LREAL	Positive number, 0, negative number (0)	When <i>Execute</i> changes from FALSE to TRUE.
Q_StartPos	Specify the start position of Q axis.	LREAL	Positive number, 0, negative number	When <i>Execute</i> changes from

Parameter name	Function	Data type	Valid range (Default)	Validation timing
			(0)	FALSE to TRUE.

● Output Parameters

Parameter name	Function	Data type	Valid range
Done	TRUE when the instruction execution is completed.	BOOL	TRUE / FALSE
Busy	TRUE when the instruction is being executed.	BOOL	TRUE / FALSE
Error	TRUE when an error occurs in execution of the instruction.	BOOL	TRUE / FALSE
ErrorID	Contains the error code when an error occurs. Please refer to section 12.2.	WORD	-

● Output Update Timing

Name	Timing for changing to TRUE	Timing for changing to FALSE
Done	◆ When the setting is completed.	◆ When <i>Execute</i> changes from TRUE to FALSE after the instruction execution is completed.
Busy	◆ When <i>Execute</i> changes to TRUE.	◆ When <i>Done</i> changes to TRUE ◆ When <i>Error</i> changes to TRUE
Error	◆ When an input parameter is illegal or an error occurs during the instruction execution.	◆ When <i>Execute</i> changes from TRUE to FALSE.

● Output Update Timing Chart

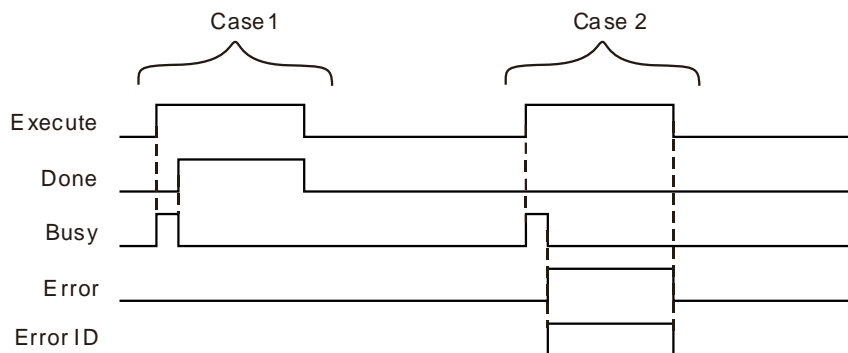

Case 1 : When *Execute* changes from FALSE to TRUE, *Busy* changes to TRUE and one cycle later, *Done* changes to TRUE and *Busy* changes to FALSE.

Case 2 : When an error occurs during the instruction execution, *Error* changes to TRUE and *ErrorID* shows corresponding error code. Meanwhile, *Busy* changes to FALSE. *Error* changes to FALSE when *Execute* changes from TRUE to FALSE.

● Function

DMC_SetStartPosition instruction sets the start positions of 8 axes of G code. After the instruction is executed, the motion begins from the start positions of X, Y, Z, A, B, C, P and Q axes specified by the instruction. For example, the start position of X axis is set to 10000 and G code is G0 X1000. So if G code is to be executed, for X axis, the motion will begin from the position 10000 and get to 1000. The firmware of V1.01 and above supports the function.

The start positions need not be set with the instruction if the DMC_CartesianCoordinate instruction is used to perform G code. The DMC_CartesianCoordinate instruction will set the start positions automatically.

11 **Programming Example**

1. The variable table and program

Variable name	Data type	Initial value
SSP	DMC_SetStartPosition	
Axes1	USINT	1
SSP_Ex	BOOL	FALSE
SSP_X	LREAL	1000
SSP_Y	LREAL	1000
SSP_Z	LREAL	1000
SSP_A	LREAL	1000
SSP_B	LREAL	1000
SSP_C	LREAL	1000
SSP_P	LREAL	1000
SSP_Q	LREAL	1000
SSP_Done	BOOL	
SSP_Bsy	BOOL	
SSP_Err	BOOL	
SSP_ErrID	WORD	

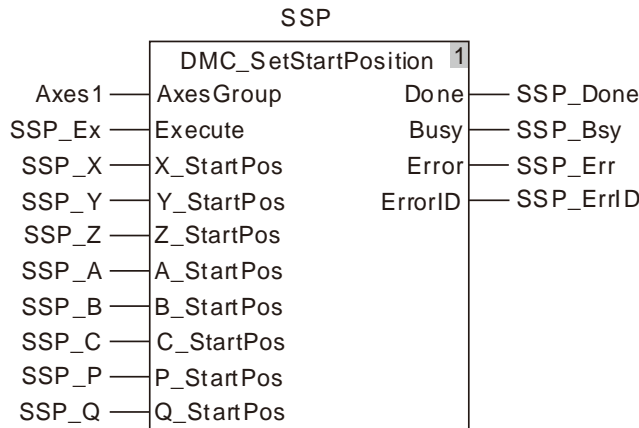

2. Timing Chart

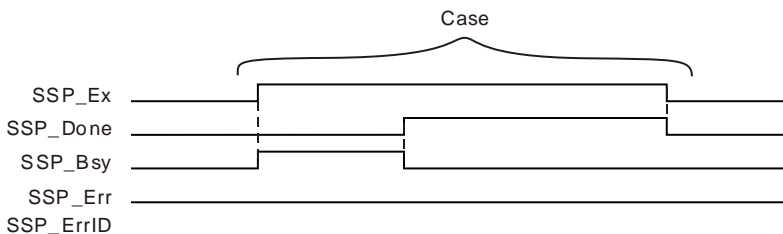

- ❖ When SSP_Ex changes from FALSE to TRUE, DMC_SetStartPosition instruction is executed. In the same cycle, SSP_Bsy changes from FALSE to TRUE. In the second cycle, SSP_Done changes from FALSE to TRUE and meanwhile SSP_Bsy changes from TRUE to FALSE. So the start positions of axes in G codes for the motion is the start positions set by the instruction.
- ❖ When SSP_Ex changes from TRUE to FALSE, SSP_Done changes from TRUE to FALSE.

11.7 Axes Group Instructions

11.7.1 DMC_AddAxisToGroup

FB/FC	Explanation	Applicable model
FB	DMC_AddAxisToGroup is used to add an axis to an axes group.	DVP15MC11T DVP15MC11T-06

DMC_AddAxisToGroup_instance

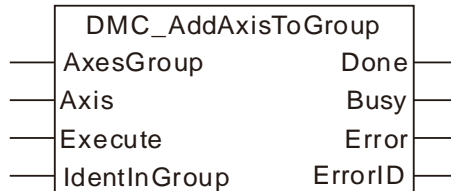

● Input Parameters

Parameter name	Function	Data type	Valid range (Default)	Validation timing
AxesGroup	The axes group number	USINT	1~8 (The variable value must be set)	When <i>Execute</i> changes from FALSE to TRUE.
Axis	The axis number of the axis which is added to the axes group	USINT	Refer to Functions of Section 2.2. (The variable value must be set)	When <i>Execute</i> changes from FALSE to TRUE.
Execute	The instruction is executed when <i>Execute</i> changes from FALSE to TRUE.	BOOL	TRUE or FALSE (FALSE)	
IdentInGroup	The Identity number of an axis in the axes group	USINT	1~8 (The variable value must be set)	When <i>Execute</i> changes from FALSE to TRUE.

● Output Parameters

Parameter name	Function	Data type	Valid range
Done	TRUE when the instruction execution is completed.	BOOL	TRUE / FALSE
Busy	TRUE when the instruction is being executed.	BOOL	TRUE / FALSE
Error	TRUE when an error occurs in execution of the instruction.	BOOL	TRUE / FALSE
ErrorID	Contains the error code when an error occurs. Please refer to section 12.2.	WORD	

● **Output Update Timing**

Name	Timing for changing to TRUE	Timing for changing to FALSE
Done	◆ When adding the axis to the axes group is finished.	◆ When <i>Execute</i> changes from TRUE to FALSE
Busy	◆ When <i>Execute</i> changes to TRUE	◆ When <i>Done</i> changes to TRUE ◆ When <i>Error</i> changes to TRUE
Error	◆ When an error occurs in the instruction execution or the input parameters for the instruction are illegal.	◆ When <i>Execute</i> changes from TRUE to FALSE

● **Output Update Timing Chart**

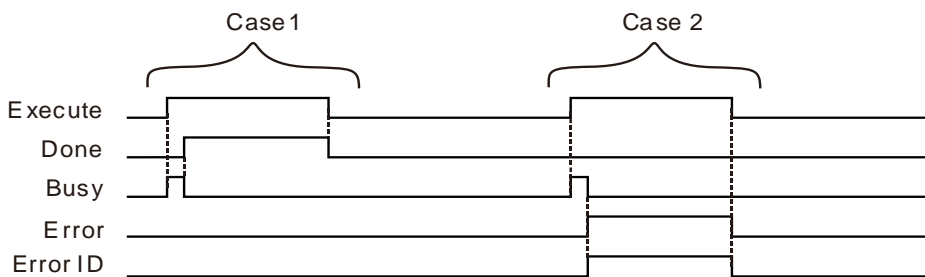

Case 1 : When *Execute* changes from FALSE to TRUE, *Busy* changes to TRUE and one cycle later, *Done* changes to TRUE and *Busy* changes to FALSE. When *Execute* changes from TRUE to FALSE, *Done* changes to FALSE.

Case 2 : When an error occurs during the instruction execution, *Error* changes to TRUE and *ErrorID* shows corresponding error code. Meanwhile, *Busy* changes to FALSE. *Error* changes to FALSE and the value in *ErrorID* is cleared to 0 when *Execute* changes from TRUE to FALSE.

● **Function**

DMC_AddAxisToGroup is used to add an axis to an axes group and set the number of the axis in the axes group. The firmware of V1.01 and above supports the function.

1. When *Done* of DMC_AddAxisToGroup changes to TRUE, it means the axis is added to the axes group successfully. Changing *Execute* to FALSE can not remove the axis from the axis group. To remove the axis from the axes group, DMC_RemoveAxisFromGroup instruction is needed. Refer to section 11.7.2 for more details about explanation of DMC_RemoveAxisFromGroup instruction.
2. *IdentInGroup* is the identity number of an axis in the axes group. Range:1~8. 1: X axis, 2: Y axis, 3: Z axis, 4: A axis, 5: B axis, 6: C axis, 7: P axis and 8: Q axis.
3. DMC_AddAxisToGroup instruction can be executed only before the axes group is enabled. If the instruction is executed after the axes group is enabled, an error will occur in the instruction.

11.7.2 DMC_RemoveAxisFromGroup

FB/FC	Explanation	Applicable model
FB	DMC_RemoveAxisFromGroup is used to remove an axis from an axes group.	DVP15MC11T DVP15MC11T-06

DMC_RemoveAxisFromGroup_instance

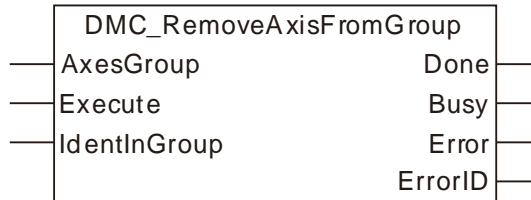

● Input Parameters

Parameter name	Function	Data type	Valid range (Default)	Validation timing
AxesGroup	The axes group number	USINT	1~8 (The variable value must be set)	When <i>Execute</i> changes from FALSE to TRUE.
Execute	The instruction is executed when <i>Execute</i> changes from FALSE to TRUE.	BOOL	TRUE or FALSE (FALSE)	
IdentInGroup	The identity number of the axis to be removed from the axes group	INT	1~8 (The variable value must be set)	When <i>Execute</i> changes from FALSE to TRUE.

● Output Parameters

Parameter name	Function	Data type	Valid range
Done	TRUE when the instruction execution is completed.	BOOL	TRUE / FALSE
Busy	TRUE when the instruction is being executed.	BOOL	TRUE / FALSE
Error	TRUE when an error occurs in execution of the instruction.	BOOL	TRUE / FALSE
ErrorID	Contains the error code when an error occurs. Please refer to section 12.2.	WORD	

● Output Update Timing

Name	Timing for changing to TRUE	Timing for changing to FALSE
Done	◆ When the axis is removed from the axes group.	◆ When <i>Execute</i> changes from TRUE to FALSE
Busy	◆ When the instruction is being executed.	◆ When <i>Execute</i> changes from TRUE to FALSE ◆ When <i>Done</i> changes to TRUE ◆ When <i>Error</i> changes to TRUE
Error	◆ When an error occurs in the instruction execution or the input parameters for the instruction are illegal.	◆ When <i>Execute</i> changes from TRUE to FALSE

● **Output Update Timing Chart**

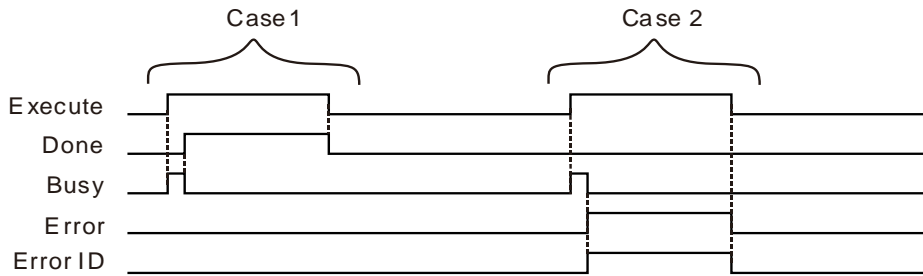

- Case 1 :** When *Execute* changes from FALSE to TRUE, *Busy* changes to TRUE and one cycle later, *Done* changes to TRUE and *Busy* changes to FALSE. When *Execute* changes from TRUE to FALSE, *Done* changes to FALSE.
- Case 2 :** When there is an error in the input parameters of the instruction or the axes group is not disabled and *Execute* changes from FALSE to TRUE, *Busy* changes to TRUE and one cycle later, *Error* changes to TRUE and *ErrorID* shows error codes and meanwhile *Busy* changes to FALSE. When *Execute* changes from TRUE to FALSE, *Error* changes to FALSE and the value in *ErrorID* is cleared to 0.

● **Function**

DMC_RemoveAxisFromGroup is used to remove an axis from an axes group. The value of the input parameter *IdentInGroup* should be within the ranges of 1~8. If the range is exceeded, an error will occur. The firmware of V1.01 and above supports the function.

As the instruction is executed, an error in the instruction will occur immediately if the axes group is enabled. The instruction can be used only when the axes group is not enabled.

11.7.3 DMC_UngroupAllAxes

FB/FC	Explanation	Applicable model
FB	DMC_UngroupAllAxes is used to remove all axes in an axes group.	DVP15MC11T DVP15MC11T-06

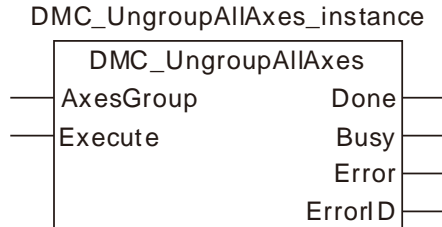

● Input Parameters

Parameter name	Function	Data type	Valid range (Default)	Validation timing
AxesGroup	The axes group number	USINT	1~8 (The variable value must be set)	When <i>Execute</i> changes from FALSE to TRUE.
Execute	The instruction is executed when <i>Enable</i> changes from FALSE to TRUE.	BOOL	TRUE or FALSE (FALSE)	

● Output Parameters

Parameter name	Function	Data type	Valid range
Done	TRUE when the instruction execution is completed.	BOOL	TRUE / FALSE
Busy	TRUE when the instruction is being executed.	BOOL	TRUE / FALSE
Error	TRUE when an error occurs in execution of the instruction.	BOOL	TRUE / FALSE
ErrorID	Contains the error code when an error occurs. Please refer to section 12.2.	WORD	

● Output Update Timing

Name	Timing for changing to TRUE	Timing for changing to FALSE
Done	◆ When the axes group is ungrouped.	◆ When <i>Execute</i> changes from TRUE to FALSE
Busy	◆ When the instruction is executed.	◆ When <i>Execute</i> changes from TRUE to FALSE ◆ When <i>DONE</i> changes to TRUE ◆ When <i>Error</i> changes to TRUE
Error	◆ When an error occurs in the instruction execution or the input parameters for the instruction are illegal.	◆ When <i>Execute</i> changes from TRUE to FALSE

● **Output Update Timing Chart**

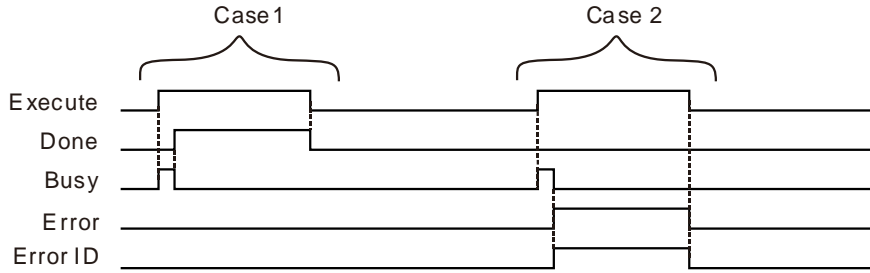

Case 1 : When *Execute* changes from FALSE to TRUE, *Busy* changes to TRUE and one cycle later, *Done* changes to TRUE and *Busy* changes to FALSE. When *Execute* changes from TRUE to FALSE, *Done* changes to FALSE.

Case 2 : When there is an error in the input parameters of the instruction or the axes group is not disabled and *Execute* changes from FALSE to TRUE, *Busy* changes to TRUE and one cycle later, *Error* changes to TRUE and *ErrorID* shows error codes and meanwhile *Busy* changes to FALSE. When *Execute* changes from TRUE to FALSE, *Error* changes to FALSE and the value in *ErrorID* is cleared to 0.

● **Function**

DMC_UngroupAllAxes is used to remove all axes in an axes group. When the axes group is enabled, an error will occur immediately after the instruction is used. The firmware of V1.01 and above supports the function.

11.7.4 DMC_GroupEnable

FB/FC	Explanation	Applicable model
FB	DMC_GroupEnable is used to enable an axes group.	DVP15MC11T DVP15MC11T-06

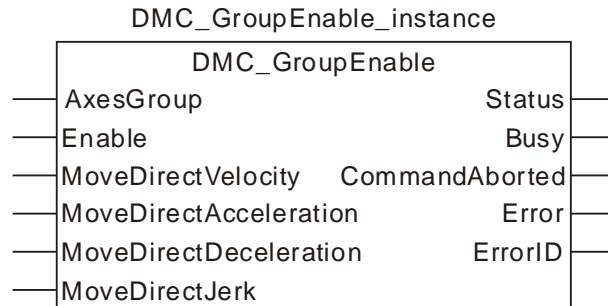

● Input Parameters

Parameter name	Function	Data type	Valid range (Default)	Validation timing
AxesGroup	The axes group number	USINT	1~8 (The variable value must be set)	When <i>Enable</i> changes to TRUE
Enable	The instruction is executed when <i>Enable</i> changes from FALSE to TRUE.	BOOL	TRUE or FALSE (FALSE)	
MoveDirectVelocity	The velocities of axes for quick positioning	ARRAY [1..8] OF LREAL	Positive number (The variable value must be set)	When <i>Enable</i> changes to TRUE.
MoveDirectAcceleration	The accelerations of axes for quick positioning	ARRAY [1..8] OF LREAL	Positive number (The variable value must be set)	When <i>Enable</i> changes to TRUE.
MoveDirectDeceleration	The decelerations of axes for quick positioning	ARRAY [1..8] OF LREAL	Positive number (The variable value must be set)	When <i>Enable</i> changes to TRUE.
MoveDirectJerk	The jerks of all axes for quick positioning	ARRAY [1..8] OF LREAL	Positive number (The variable value must be set)	When <i>Enable</i> changes to TRUE.

Note: An axes group can not be controlled to make corresponding action unless it has been enabled. The quick positioning, linear interpolation and circular interpolation could not be conducted when the axes group is not enabled.

● Output Parameter

Parameter name	Function	Data type	Valid range
Status	TRUE when the axes group is enabled.	BOOL	TRUE / FALSE
Busy	TRUE when the instruction is being executed.	BOOL	TRUE / FALSE
CommandAborted	TRUE when the instruction execution is aborted.	BOOL	TRUE/FALSE
Error	TRUE when an error occurs in execution of the instruction.	BOOL	TRUE / FALSE

Parameter name	Function	Data type	Valid range
ErrorID	Contains the error code when an error occurs. Please refer to section 12.2.	WORD	

● **Output Update Timing**

Name	Timing for changing to TRUE	Timing for changing to FALSE
Status	◆ When the specified axes group has been enabled.	◆ When the specified axes group is disabled ◆ When <i>Error</i> changes to TRUE
Busy	◆ When the instruction is being executed.	◆ When <i>Enable</i> changes from TRUE to FALSE ◆ When <i>Error</i> changes to TRUE
CommandAborted	◆ When the instruction execution is aborted.	◆ When <i>Enable</i> changes from TRUE to FALSE
Error	◆ When an error occurs in the instruction execution or the input parameters for the instruction are illegal.	◆ When <i>Enable</i> changes from TRUE to FALSE

● **Output Update Timing Chart**

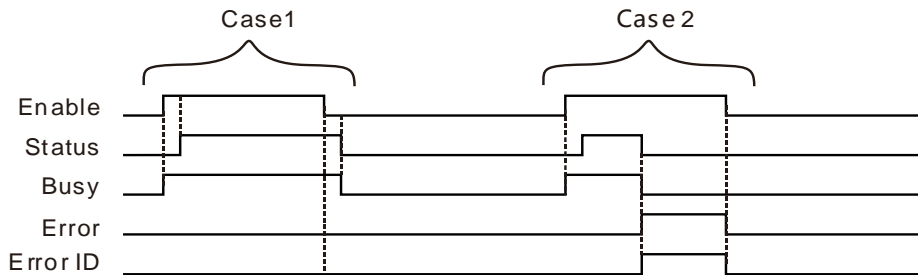

Case 1 : When *Enable* changes from FALSE to TRUE, *Busy* changes to TRUE. After the axes group is enabled successfully, *Status* changes to TRUE. After *Enable* changes from TRUE to FALSE and the axes group is disabled, *Busy and Status* change from TRUE to FALSE.

Case 2 : When the DMC_GroupEnable instruction is aborted during the execution, *CommandAborted* changes to TRUE, meanwhile *Status and Busy* change to FALSE and the axes group is disabled. When *Enable* changes to FALSE, *CommandAborted* changes to FALSE.

Case 3 : When an error occurs during the instruction execution, *Error* changes to TRUE and *ErrorID* shows corresponding error codes and meanwhile *Status and Busy* change to FALSE. When *Enable* changes to FALSE, *Error* changes to FALSE and the value in *ErrorID* is cleared to 0.

● **Function**

DMC_GroupEnable is used to enable or disable an axes group. The firmware of V1.01 and above supports the function.

1. Before the DMC_GroupEnable instruction is executed, all axes in an axes group must be in the StandStill state so that the DMC_GroupEnable instruction can be executed normally. The MC_Power instruction must be used to enable axes and make them enter the StandStill state.
2. When axes are in StandStill state, *Status* changes to TRUE after *Enable* is set to TRUE. Please make sure that *Status* has changed to TRUE before the axes group motion is controlled. After *Status* changes to TRUE, axes enter the Discrete Motion state. *Enable* need be set to FALSE in order to execute other motion instructions which can be executed only when axes are in StandStill state.

3. After *Enable* changes from TRUE to FALSE, the axes group is disabled and axes are in the StandStill state. If *Enable* changes from TRUE to FALSE as an axes group instruction such as DMC_MoveDirectAbsolute is being executed, the axes group instruction will report an error, all axes in the axes group will stop running and axes will be in the StandStill state.
4. If a single-axis instruction is executed during the execution of the axes group instruction and the value of *BufferMode* of the single-axis instruction is set to 0 (mcAborting), the single-axis instruction will abort the axes group instruction and the axes group will be disabled. If the value of *BufferMode* of the single-axis instruction is set to a non-zero number (1~5), the single-axis instruction will not be executed.
5. Before the DMC_GroupEnable instruction is executed, all axes in an axes group must be in the StandStill state so that the DMC_GroupEnable instruction can be executed normally.

11.7.5 DMC_GroupStop

FB/FC	Explanation	Applicable model
FB	DMC_GroupStop is used to stop the motion of the current axes group.	DVP15MC11T DVP15MC11T-06

11

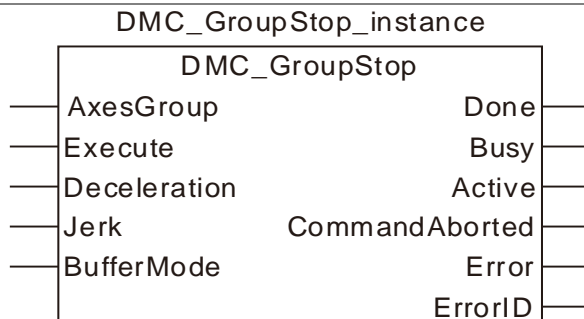

● **Input Parameters**

Parameter name	Function	Data type	Valid range (Default)	Validation timing
AxesGroup	Specify the number of the axes group which is to be controlled	USINT	1~8 (The variable value must be set)	When <i>Execute</i> changes from FALSE to TRUE
Execute	The instruction is executed when <i>Execute</i> changes from FALSE to TRUE.	BOOL	TRUE or FALSE (FALSE)	
Deceleration	Reserved	-	-	-
Jerk	Reserved	-	-	-
BufferMode	Specify the behavior when executing two instructions. 0: Abort	MC_Buffer_Mode	0: mcAborting	When <i>Execute</i> changes from FALSE to TRUE

Note:

1. *Deceleration* and *Jerk* are reserved and their setting values are invalid.
2. *BufferMode* does not support any mode except mode 0 (mcAborting). If any mode else is selected, an error will occur during the execution of the instruction.

● **Output Parameters**

Parameter name	Function	Data type	Valid range
Done	TRUE when the instruction execution is completed.	BOOL	TRUE/FALSE
Busy	TRUE when the instruction is being executed.	BOOL	TRUE/FALSE
Active	TRUE when the axes group is being controlled.	BOOL	TRUE/FALSE
CommandAborted	TRUE when the instruction is aborted.	BOOL	TRUE/FALSE
Error	TRUE when there is an error.	BOOL	TRUE/FALSE
ErrorID	Contains error codes when an error occurs. Please refer to section 12.2 for the corresponding error code.	WORD	

■ Output Update Timing

Name	Timing for changing to TRUE	Timing for changing to FALSE
Done	◆ When the axes group motion is stopped.	◆ When <i>Execute</i> changes from TRUE to FALSE. ◆ When <i>Error</i> changes from TRUE to FALSE.
Busy	◆ When <i>Execute</i> changes to TRUE	◆ When <i>Execute</i> changes from TRUE to FALSE. ◆ When <i>CommandAborted</i> changes from FALSE to TRUE. ◆ When <i>Error</i> changes from FALSE to TRUE.
Active	◆ When the instruction is controlling the axes group.	◆ When <i>Execute</i> changes from TRUE to FALSE. ◆ When <i>CommandAborted</i> changes from FALSE to TRUE. ◆ When <i>Error</i> changes from FALSE to TRUE.
CommandAborted	◆ When the instruction execution is aborted.	◆ When <i>Execute</i> changes from TRUE to FALSE.
Error	◆ When an error occurs in the instruction execution or the input parameters for the instruction are illegal.	◆ When <i>Execute</i> changes from TRUE to FALSE.

■ Output Update Timing Chart

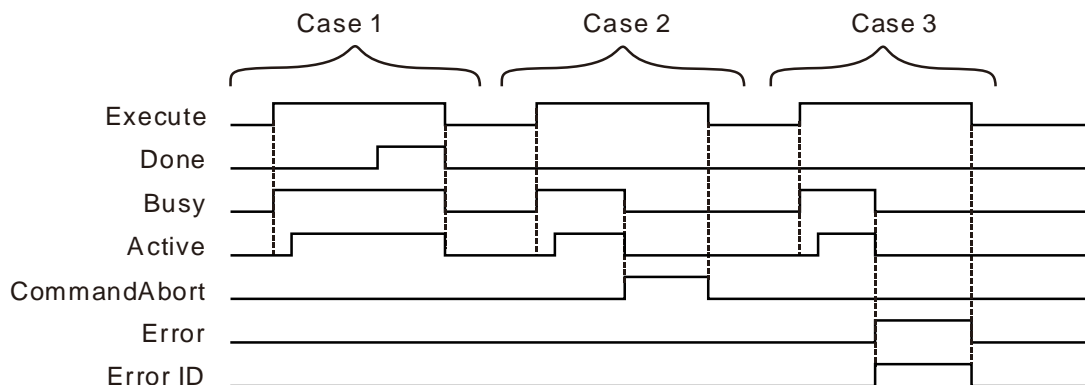

- Case 1:** When *Execute* changes from FALSE to TRUE, *Busy* changes to TRUE and one period later, *Active* changes to TRUE. When the motion of the axes group is stopped successfully, *Done* changes to TRUE and *Busy* and *Active* remain TRUE. When *Execute* changes from TRUE to FALSE, *Done*, *Busy* and *Active* change to FALSE.
- Case 2:** When the DMC_GroupStop instruction is aborted during the execution, *CommandAborted* changes to TRUE and meanwhile *Busy* and *Active* change to FALSE. When *Execute* changes to FALSE, *CommandAborted* changes to FALSE.
- Case 3:** When an error occurs in the course of the instruction execution, *Error* changes to TRUE and *ErrorID* shows the corresponding error code. Meanwhile, *Busy* and *Active* change to FALSE.

Error changes to FALSE and the value in *ErrorID* is cleared to 0 when *Execute* changes to FALSE.

● **Function**

DMC_GroupStop is used to stop the motion of the current axes group.

1. The input parameters *Deceleration* and *Jerk* of the DMC_GroupStop instruction are reserved and the input values for them are invalid. When the DMC_GroupStop instruction is executed, all axes in the axes group will stop running immediately.
2. The DMC_GroupStop instruction can be executed only while the axes group instructions such as DMC_MoveDirectAbsolute, DMC_MoveDirectRelative, DMC_MoveLinearAbsolute, DMC_MoveLinearRelative, DMC_MoveCircularAbsolute and DMC_MoveCircularRelative are being executed. After the instruction execution is completed, all axes in the axes group will stop running and the axis status will still be the Discrete Motion state. Before other motion instructions which can be executed only when axes are in StandStill state are executed, *Enable* of the DMC_GroupEnable instruction must be set to FALSE.
3. When *Execute* of the DMC_GroupStop instruction changes from FALSE to TRUE, the instruction is executed. After the instruction execution is completed, the axes group instructions DMC_MoveDirectAbsolute, DMC_MoveDirectRelative, DMC_MoveLinearAbsolute, DMC_MoveLinearRelative, DMC_MoveCircularAbsolute and DMC_MoveCircularRelative all can not be executed. These instructions can be executed only after *Execute* of the DMC_GroupStop instruction changes into FALSE.



Programming Example

The example of how to use DMC_GroupStop instruction is described as follows.

1. The variable table and program

Variable name	Data type	Initial value
M1	BOOL	TRUE
DMC_AddAxisToGroup0	DMC_AddAxisToGroup	
ADDAXIS_Ex	BOOL	
ADDAXIS_Done	BOOL	
ADDAXIS_Bsy	BOOL	
ADDAXIS_Err	BOOL	
ADDAXIS_Eid	WORD	
DMC_AddAxisToGroup1	DMC_AddAxisToGroup	
ADDAXIS_Done1	BOOL	
ADDAXIS_Bsy1	BOOL	
ADDAXIS_Err1	BOOL	
ADDAXIS_Eid1	WORD	
DMC_GroupEnable0	DMC_GroupEnable	
GE_EN	BOOL	
GE_VEL	ARRAY [1..8] OF LREAL	[10000,10000]
GE_ACC	ARRAY [1..8] OF LREAL	[10000,10000]
GE_DEC	ARRAY [1..8] OF LREAL	[10000,10000]
GE_JERK	ARRAY [1..8] OF LREAL	[10000,10000]
GE_Status	BOOL	
GE_Bsy	BOOL	
GE_Abt	BOOL	
GE_Err	BOOL	
GE_Eid	WORD	
DMC_MoveLinearAbsolute0	DMC_MoveLinearAbsolute	
LA_Ex	BOOL	
LA_Pos	ARRAY [1..8] OF LREAL	[200000,200000]
LA_Done	BOOL	
LA_Bsy	BOOL	
LA_Act	BOOL	

Variable name	Data type	Initial value
LA_Abt	BOOL	
LA_Err	BOOL	
LA_Eid	WORD	
DMC_GroupStop0	DMC_GroupStop	
GS_Ex	BOOL	
GS_Done	BOOL	
GE_Bsy	BOOL	
GE_Act	BOOL	
GE_Abt	BOOL	
GS_Err	BOOL	
GS_Eid	WORD	

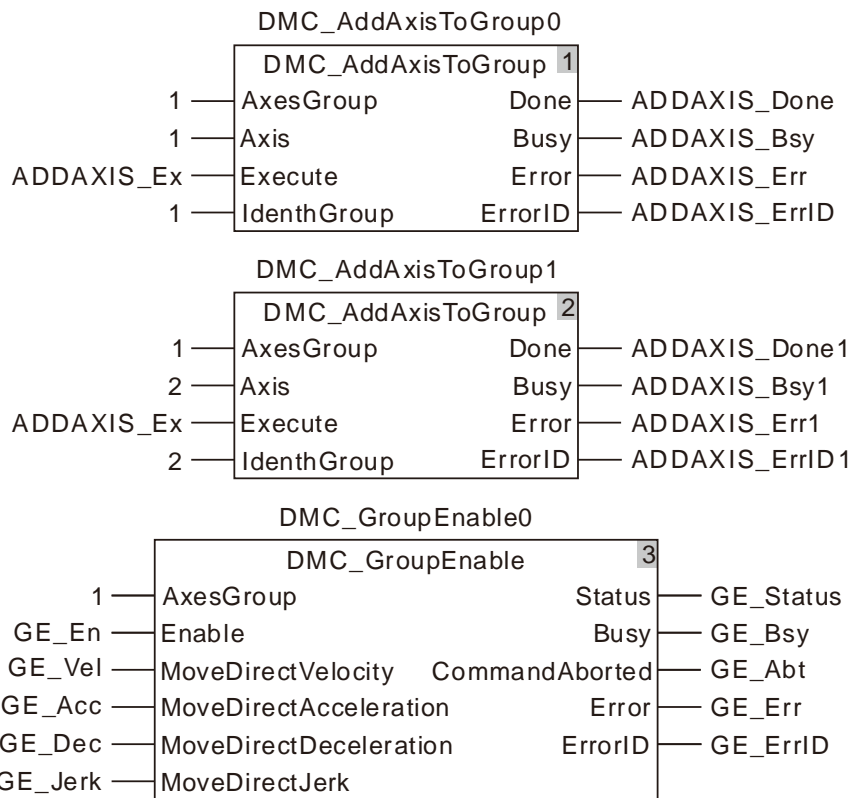

DMC_MoveLinearAbsolute0

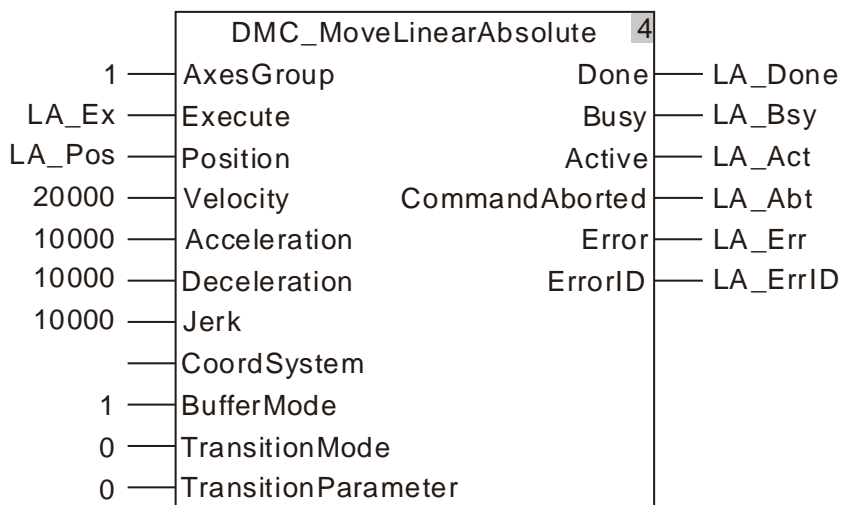

DMC_GroupStop0

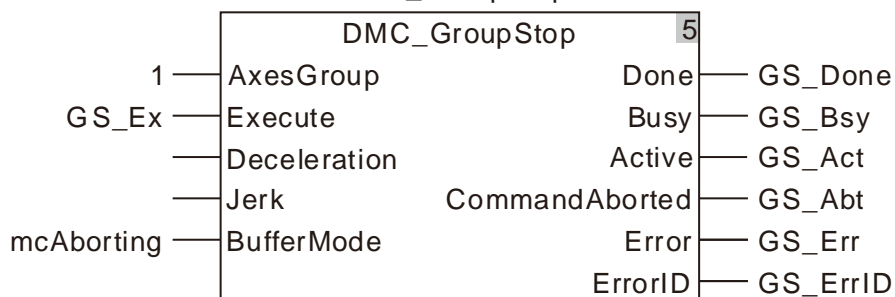

3. Motion Curve and Timing Chart:

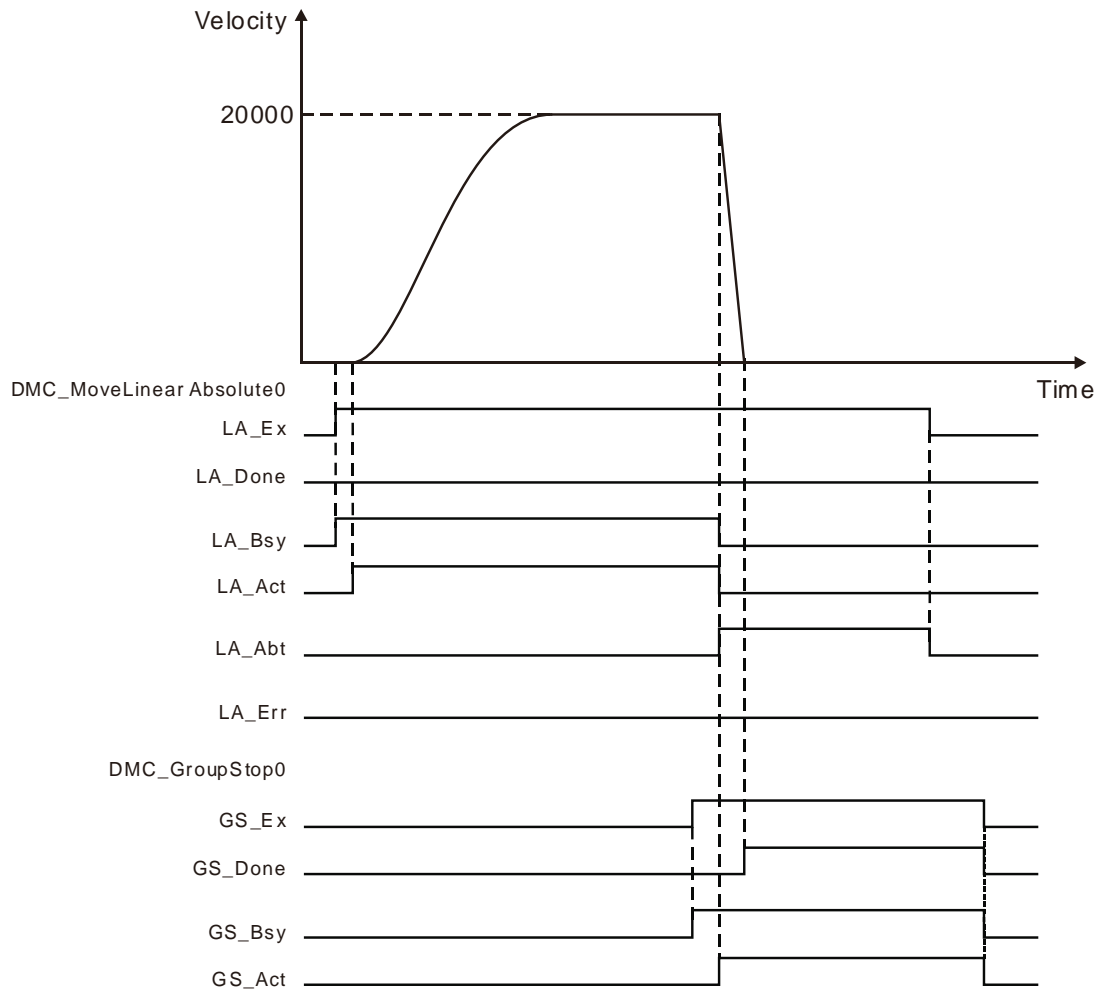

- ❖ `DMC_AddAxisToGroup` is executed and then `DMC_GroupEnable` is executed to enable the axes group. After the axes group is enabled, `DMC_MoveLinearAbsolute` is executed.
- ❖ `DMC_GroupStop` is executed during the execution of `DMC_MoveLinearAbsolute`. At the moment, the velocity of the axes group becomes 0 rapidly and `DMC_MoveLinearAbsolute` is aborted. After the axes group stops running, `Done` of `DMC_GroupStop` changes to TRUE.

11.7.6 DMC_GroupInterrupt

FB/FC	Explanation	Applicable model
FB	DMC_GroupInterrupt is used to pause the motion of the current axes group for a period of time.	DVP15MC11T DVP15MC11T-06

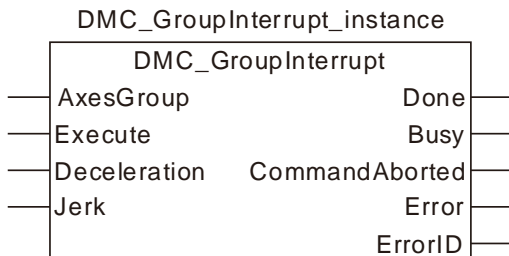

● **Input Parameters**

Parameter name	Function	Data type	Valid range (Default)	Validation timing
AxesGroup	Specify the number of the axes group which is to be enabled	USINT	1~8 (The variable value must be set)	When <i>Execute</i> changes from FALSE to TRUE
Execute	The instruction is executed when <i>Execute</i> changes from FALSE to TRUE.	BOOL	TRUE or FALSE (FALSE)	
Deceleration	Reserved	-	-	-
Jerk	Reserved	-	-	-

Note:

Deceleration and *Jerk* are reserved and their setting values are invalid.

● **Output Parameter**

Parameter name	Function	Data type	Valid range
Done	TRUE when the instruction execution is completed.	BOOL	TRUE / FALSE
Busy	TRUE when the instruction is being executed.	BOOL	TRUE / FALSE
CommandAborted	TRUE when the instruction is aborted.	BOOL	TRUE / FALSE
Error	TRUE when there is an error.	BOOL	TRUE / FALSE
ErrorID	Contains error codes when an error occurs. Please refer to section 12.2 for the corresponding error code.	WORD	

● **Output Update Timing**

Name	Timing for changing to TRUE	Timing for changing to FALSE
Done	◆ When the axes group is paused successfully.	◆ When <i>Execute</i> changes from TRUE to FALSE.
Busy	◆ When <i>Execute</i> changes to TRUE.	◆ When <i>Done</i> changes from FALSE to TRUE. ◆ When <i>CommandAborted</i> changes from FALSE to TRUE. ◆ When <i>Error</i> changes from FALSE to TRUE.

Name	Timing for changing to TRUE	Timing for changing to FALSE
CommandAborted	◆ When the instruction execution is aborted.	◆ When <i>Execute</i> changes from TRUE to FALSE.
Error	◆ When an error occurs in the instruction execution or the input parameters for the instruction are illegal.	◆ When <i>Execute</i> changes from TRUE to FALSE.

- **Output Update Timing Chart**

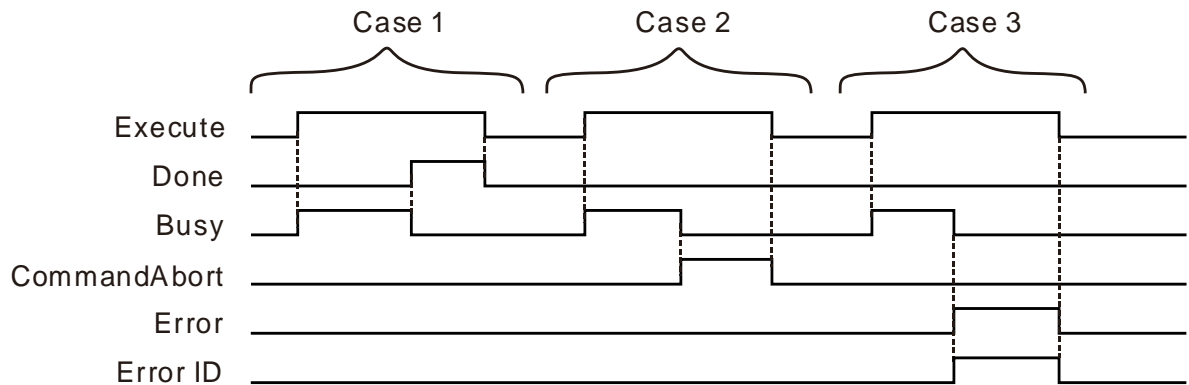

Case 1 : When *Execute* changes from FALSE to TRUE, *Busy* changes to TRUE. When the axes group is paused successfully, *Done* changes to TRUE and *Busy* changes to FALSE. When *Execute* changes from TRUE to FALSE, *Done* changes to FALSE.

Case 2 : When the instruction execution is aborted, *CommandAborted* changes to TRUE and *Busy* changes to FALSE. When *Execute* changes to FALSE, *CommandAborted* changes to FALSE.

Case 3 : When an error occurs in the course of the instruction execution, *Error* changes to TRUE and *ErrorID* shows the corresponding error code. Meanwhile, *Busy* changes to FALSE. *Error* changes to FALSE and the value in *ErrorID* is cleared to 0 when *Execute* changes to FALSE.

- **Function**

DMC_GroupInterrupt is used to pause the motion of the current axes group for a period of time.

1. The input parameters *Deceleration* and *Jerk* of the DMC_GroupInterrupt instruction are reserved and the input values for them are invalid. When the DMC_GroupInterrupt instruction is executed, the PLC will decelerate at the deceleration rate of the axes group instruction controlling the motion of the axes group until the axes group stops running.
2. The DMC_GroupInterrupt instruction can be executed only while the axes group instructions DMC_MoveDirectAbsolute, DMC_MoveDirectRelative, DMC_MoveLinearAbsolute, DMC_MoveLinearRelative, DMC_MoveCircularAbsolute and DMC_MoveCircularRelative are being executed normally.
3. DMC_GroupContinue can be used to restore the axes group to the state before being paused after DMC_GroupInterrupt is executed.
4. The execution results are consistent when several DMC_GroupInterrupt instructions are executed simultaneously.



 **Programming Example**

The example of using DMC_GroupInterrupt with DMC_GroupContinue together is described as follows.

1. The variable table and program

Variable name	Data type	Initial value
M1	BOOL	TRUE
DMC_AddAxisToGroup0	DMC_AddAxisToGroup	
ADDAXIS_Ex	BOOL	
ADDAXIS_Done	BOOL	
ADDAXIS_Bsy	BOOL	
ADDAXIS_Err	BOOL	
ADDAXIS_ErrID	WORD	
DMC_AddAxisToGroup1	DMC_AddAxisToGroup	
ADDAXIS_Done1	BOOL	
ADDAXIS_Bsy1	BOOL	
ADDAXIS_Err1	BOOL	
ADDAXIS_ErrID1	WORD	
DMC_GroupEnable0	DMC_GroupEnable	
GE_En	BOOL	
GE_Vel	ARRAY [1..8] OF LREAL	[10000,10000]
GE_Acc	ARRAY [1..8] OF LREAL	[10000,10000]
GE_Dec	ARRAY [1..8] OF LREAL	[10000,10000]
GE_Jerk	ARRAY [1..8] OF LREAL	[10000,10000]
GE_Status	BOOL	
GE_Buy	BOOL	
GE_Abt	BOOL	
GE_Err	BOOL	
GE_ErrID	WORD	
DMC_MoveLinearAbsolute0	DMC_MoveLinearAbsolute	
LINABS_Ex	BOOL	
LINABS_Pos	ARRAY [1..8] OF LREAL	[200000,200000]
LINABS_Done	BOOL	
LINABS_Bsy	BOOL	
LINABS_Act	BOOL	
LINABS_Abt	BOOL	
LINABS_Err	BOOL	
LINABS_ErrID	WORD	
DMC_GroupInterrupt0	DMC_GroupInterrupt	
GI_Ex	BOOL	
GI_Done	BOOL	
GI_Bsy	BOOL	
GI_Abt	BOOL	
GI_Err	BOOL	
GI_ErrID	WORD	
DMC_GroupContinue0	DMC_GroupContinue	
GC_Ex	BOOL	
GC_Done	BOOL	

Variable name	Data type	Initial value
GC_Bsy	BOOL	
GC_Abt	BOOL	
GC_Err	BOOL	
GC_ErrID	WORD	

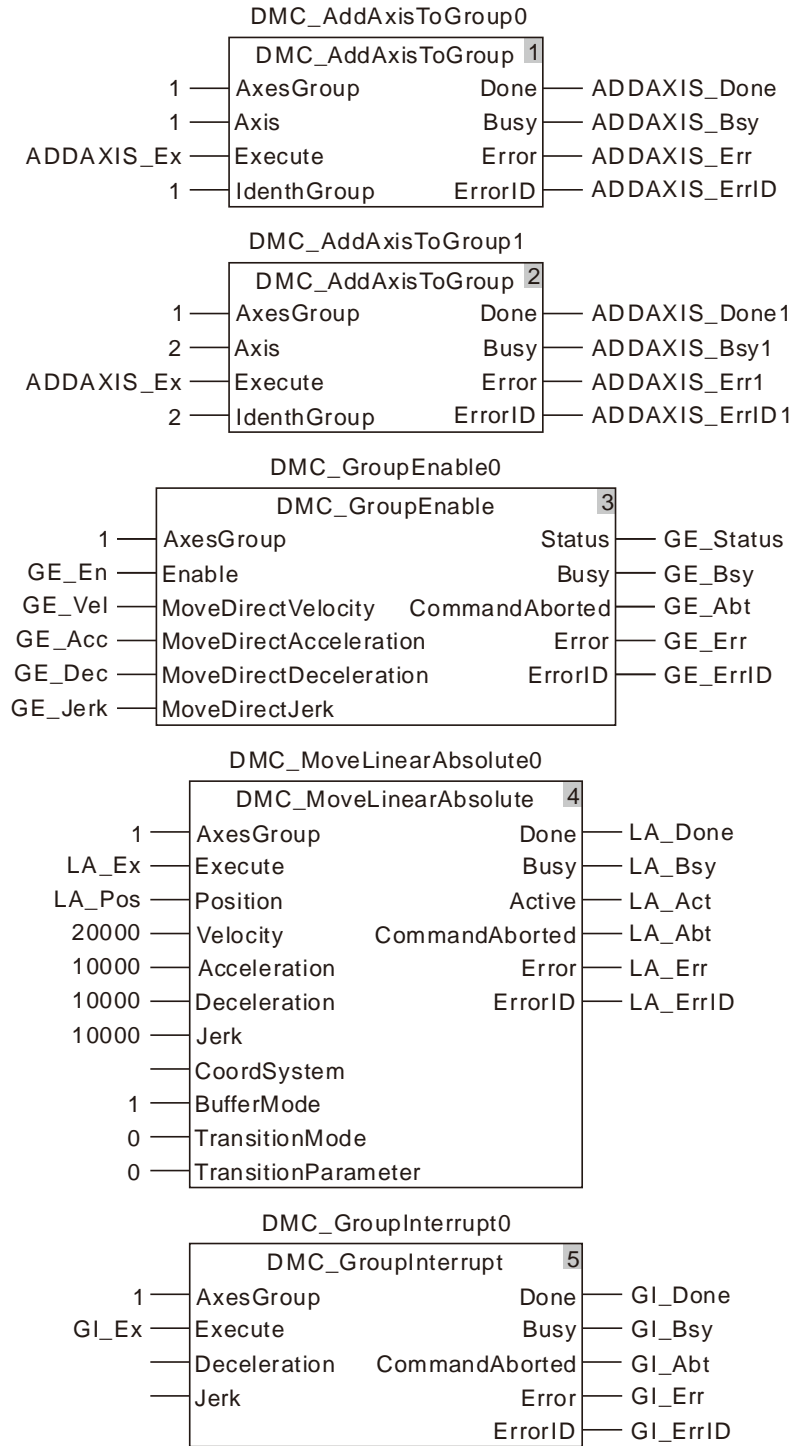

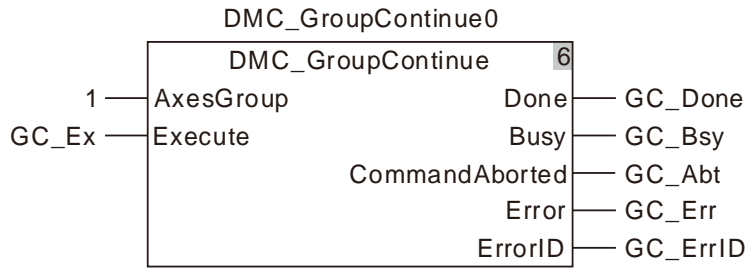

2. Motion Curve and Timing Chart:

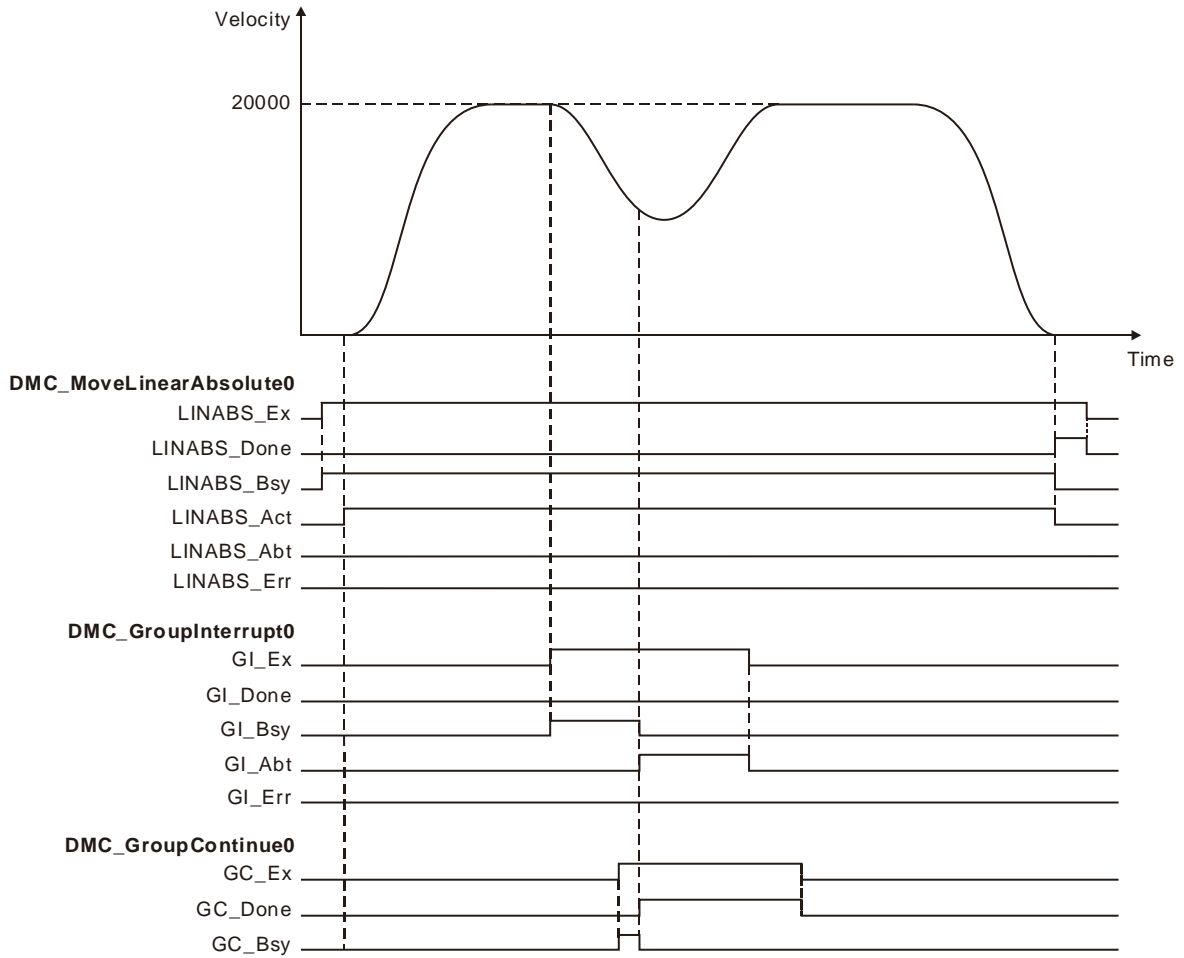

- ❖ DMC_AddAxisToGroup is executed and then DMC_GroupEnable is executed to enable the axes group. After the axes group is enabled, DMC_MoveLinearAbsolute is executed.
- ❖ DMC_GroupInterrupt is executed during the execution of DMC_MoveLinearAbsolute. After DMC_GroupInterrupt is executed, the axes group starts to decelerate at the deceleration rate of DMC_MoveLinearAbsolute instruction. But the DMC_MoveLinearAbsolute instruction is not aborted.
- ❖ DMC_GroupContinue is executed in the process of deceleration of the axes group. DMC_GroupContinue stops the execution of DMC_GroupInterrupt immediately. Meanwhile the DMC_MoveLinearAbsolute execution continues.

11.7.7 DMC_GroupContinue

FB/FC	Explanation	Applicable model
FB	DMC_GroupContinue is used to make the paused axes group continue to run.	DVP15MC11T DVP15MC11T-06

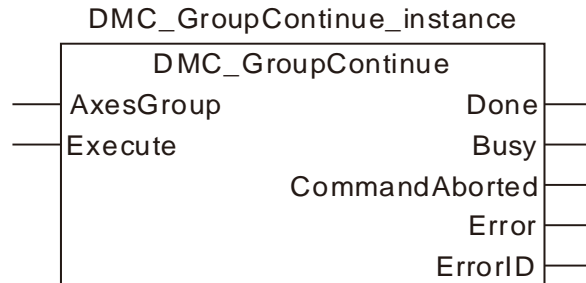

● Input Parameters

Parameter name	Function	Data type	Valid range (Default)	Validation timing
AxesGroup	Specify the number of the axes group which is to be enabled	USINT	1~8 (The variable value must be set)	When <i>Execute</i> changes from FALSE to TRUE
Execute	The instruction is executed when <i>Execute</i> changes from FALSE to TRUE.	BOOL	TRUE or FALSE (FALSE)	

● Output Parameter

Parameter name	Function	Data type	Valid range
Done	TRUE when the instruction execution is completed.	BOOL	TRUE / FALSE
Busy	TRUE when the instruction is being executed.	BOOL	TRUE / FALSE
CommandAborted	TRUE when the instruction is aborted.	BOOL	TRUE / FALSE
Error	TRUE when there is an error.	BOOL	TRUE / FALSE
ErrorID	Contains error codes when an error occurs. Please refer to section 12.2 for the corresponding error code.	WORD	

● Output Update Timing

Name	Timing for changing to TRUE	Timing for changing to FALSE
Done	◆ When the axes group continues to run.	◆ When <i>Execute</i> changes from TRUE to FALSE.
Busy	◆ When <i>Execute</i> changes to TRUE.	◆ When <i>Done</i> changes from FALSE to TRUE. ◆ When <i>CommandAborted</i> changes from FALSE to TRUE. ◆ When <i>Error</i> changes from FALSE to TRUE.
CommandAborted	◆ When the instruction execution is aborted.	◆ When <i>Execute</i> changes from TRUE to FALSE.

Name	Timing for changing to TRUE	Timing for changing to FALSE
Error	◆ When an error occurs in the instruction execution or the input parameters for the instruction are illegal.	◆ When <i>Execute</i> changes from TRUE to FALSE.

● **Output Update Timing Chart**

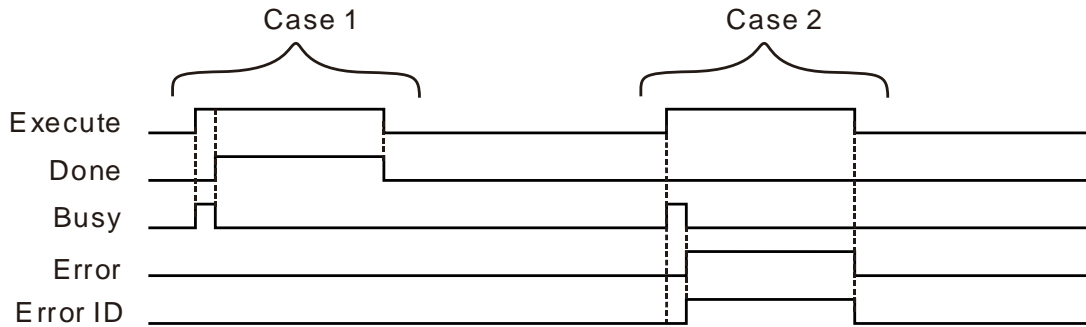

Case 1 : When *Execute* changes from FALSE to TRUE, *Busy* changes to TRUE. One period later, *Done* changes to TRUE, *Busy* changes to FALSE and the axes group motion is not paused. When *Execute* changes from TRUE to FALSE, *Done* changes to FALSE.

Case 2 : When an error occurs during the instruction execution and *Execute* changes from FALSE to TRUE, *Busy* changes to TRUE. One period later, *Error* changes to TRUE, *ErrorID* shows corresponding error codes and *Busy* changes to FALSE. When *Execute* changes from TRUE to FALSE, *Error* changes to FALSE and the value in *ErrorID* is cleared to 0.

● **Function**

DMC_GroupContinue is used to make the paused axes group continue to run.

1. DMC_GroupContinue can be executed only when the axes group instructions DMC_MoveDirectAbsolute, DMC_MoveDirectRelative, DMC_MoveLinearAbsolute, DMC_MoveLinearRelative, DMC_MoveCircularAbsolute and DMC_MoveCircularRelative are interrupted by DMC_GroupInterrupt.
2. After DMC_GroupContinue is executed, the axes group will not be paused and continue to perform the the action before being paused.

11.7.8 DMC_MoveDirectAbsolute

FB/FC	Explanation	Applicable model
FB	DMC_MoveDirectAbsolute is used to control all axes in the axes group to move from current position to end position at the specified velocity.	DVP15MC11T DVP15MC11T-06

DMC_MoveDirectAbsolute_instance

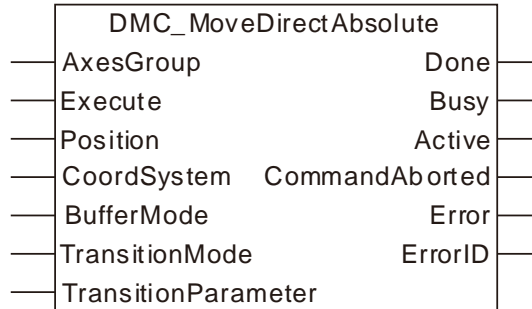

● Input Parameters

Parameter name	Function	Data type	Valid range (Default)	Validation timing
AxesGroup	The axes group number	USINT	1~8 (The variable value must be set)	When <i>Execute</i> changes from FALSE to TRUE.
Execute	The instruction is executed when <i>Execute</i> changes from FALSE to TRUE.	BOOL	TRUE or FALSE (FALSE)	
Position	The end positions of axes	ARRAY [1..8] OF LREAL	Positive number, 0, negative number (0)	When <i>Execute</i> changes from FALSE to TRUE.
CoordSystem	Reserved			
BufferMode	Specify the buffer mode between two axes group instructions 1 : Buffered	MC_Buffer_Mode	1: mcBuffered	When <i>Execute</i> changes from FALSE to TRUE.
TransitionMode	Specify the transition mode between two axes group instructions 0 : No transition curve insert	MC_Transition_Mode	0: mcTMNone	When <i>Execute</i> changes from FALSE to TRUE.
TransitionParameter	Set the transition parameter for specific transition mode	LREAL	Positive, 0 (0)	When <i>Execute</i> changes from FALSE to TRUE.

Note:

1. The execution of DMC_MoveDirectAbsolute instruction starts when *Execute* changes from FALSE to TRUE. Changing *Execute* from TRUE to FALSE during the instruction execution will have no impact on the instruction execution.
2. The value of input parameter Position[1] ~ Position[8] means the end positions for quick positioning.

3. The input *BufferMode* of DMC_MoveDirectAbsolute only supports mcBuffered mode. If other mode is selected, an error will occur when the instruction is executed. For details on BufferMode, refer to section 10.3.
4. The input *TransitionMode* of DMC_MoveDirectAbsolute only supports mcTMNone mode. If other mode is selected, an error will occur when the instruction is executed.
5. The value of the input *TransitionParameter* of DMC_MoveDirectAbsolute instruction is invalid.

● Output Parameters

Parameter name	Function	Data type	Valid range
Done	TRUE when the instruction execution is completed.	BOOL	TRUE / FALSE
Busy	TRUE when the instruction is being executed.	BOOL	TRUE / FALSE
Active	TRUE when the instruction is controlling axes.	BOOL	TRUE / FALSE
CommandAborted	TRUE when the instruction execution is aborted.	BOOL	TRUE / FALSE
Error	TRUE when an error occurs in execution of the instruction.	BOOL	TRUE / FALSE
ErrorID	Contains the error code when an error occurs. Please refer to section 12.2.	WORD	

● Output Update Timing

Name	Timing for changing to TRUE	Timing for changing to FALSE
Done	◆ When the end position is reached	<ul style="list-style-type: none"> ◆ When <i>Execute</i> changes from TRUE to FALSE after the instruction execution is completed ◆ <i>Done</i> changes to TRUE when the instruction execution is completed after <i>Execute</i> changes from TRUE to FALSE during the instruction execution. One cycle later, <i>Done</i> changes to FALSE.
Busy	◆ When <i>Execute</i> changes to TRUE	<ul style="list-style-type: none"> ◆ When <i>Done</i> changes to TRUE ◆ When <i>Error</i> changes to TRUE ◆ When <i>CommandAbort</i> changes to TRUE
Active	◆ When axes start being controlled by the instruction	<ul style="list-style-type: none"> ◆ When <i>Done</i> changes to TRUE ◆ When <i>Error</i> changes to TRUE ◆ When <i>CommandAbort</i> changes to TRUE
CommandAbort	◆ When the instruction execution is aborted by other motion instruction	◆ When <i>Execute</i> changes from TRUE to FALSE
Error	◆ When an error occurs in the instruction execution or the input parameters for the instruction are illegal.	◆ When <i>Execute</i> changes from TRUE to FALSE

- **Output Update Timing Chart**

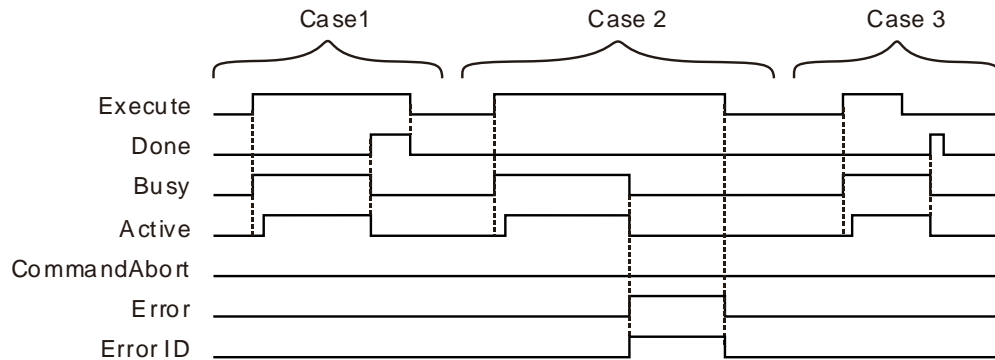

Case 1 : When *Execute* changes from FALSE to TRUE, *Busy* changes to TRUE. Two cycles later, *Active* changes to TRUE. When the axes group reaches the end position, *Done* changes to TRUE, *Busy* and *Active* change to FALSE.

Case 2 : When *Execute* changes from FALSE to TRUE and an error occurs (such as error in state machine of the axes group), *Error* changes to TRUE and *ErrorID* shows corresponding error codes and meanwhile *Active* and *Busy* change to FALSE. When *Execute* changes from TRUE to FALSE, *Error* changes to FALSE.

Case 3 : After *Execute* changes from TRUE to FALSE in the instruction execution, *Done* changes to TRUE when the instruction execution is completed. Meantime *Busy* and *Active* change to FALSE. One cycle later, *Done* changes to FALSE.

- **Function**

DMC_MoveDirectAbsolute is used for an axes group to conduct quick positioning and one or more axes in the axes group can be controlled. The firmware of V1.01 and above supports the function.

Axes are relatively independent with each other during the motion. The velocities, accelerations, decelerations and jerks of axes depend on the input values of DMC_GroupEnable: MoveDirectVelocity, MoveDirectAcceleration, MoveDirectDeceleration and MoveDirectJerk.



Programming Example

The example in which one DMC_MoveDirectAbsolute instruction is executed is as follows.

1. The variable table and program

Variable name	Data type	Initial value
ADDAXIS1	DMC_AddAxisToGroup	
ADDAXIS1_Ex	BOOL	
ADDAXIS1_Done	BOOL	
ADDAXIS1_Bsy	BOOL	
ADDAXIS1_Err	BOOL	
ADDAXIS1_ErrID	WORD	
ADDAXIS2	DMC_AddAxisToGroup	
ADDAXIS2_Done	BOOL	
ADDAXIS2_Bsy	BOOL	
ADDAXIS2_Err	BOOL	
ADDAXIS2_ErrID	WORD	
DMC_GroupEnable0	DMC_GroupEnable	
GE_En	BOOL	
GE_Vel	ARRAY [1..8] OF LREAL	
GE_Acc	ARRAY [1..8] OF LREAL	
GE_Dec	ARRAY [1..8] OF LREAL	

Variable name	Data type	Initial value
GE_Jerk	ARRAY [1..8] OF LREAL	
GE_Status	BOOL	
GE_Bsy	BOOL	
GE_Abt	BOOL	
GE_Err	BOOL	
GE_ErrID	WORD	
DIRABS	DMC_MoveDirectAbsolute	
DIRABS_Ex	BOOL	
DIRABS_Pos	ARRAY [1..8] OF LREAL	
DIRABS_Done	BOOL	
DIRABS_Bsy	BOOL	
DIRABS_Act	BOOL	
DIRABS_Abt	BOOL	
DIRABS_Err	BOOL	
DIRABS_ErrID	WORD	

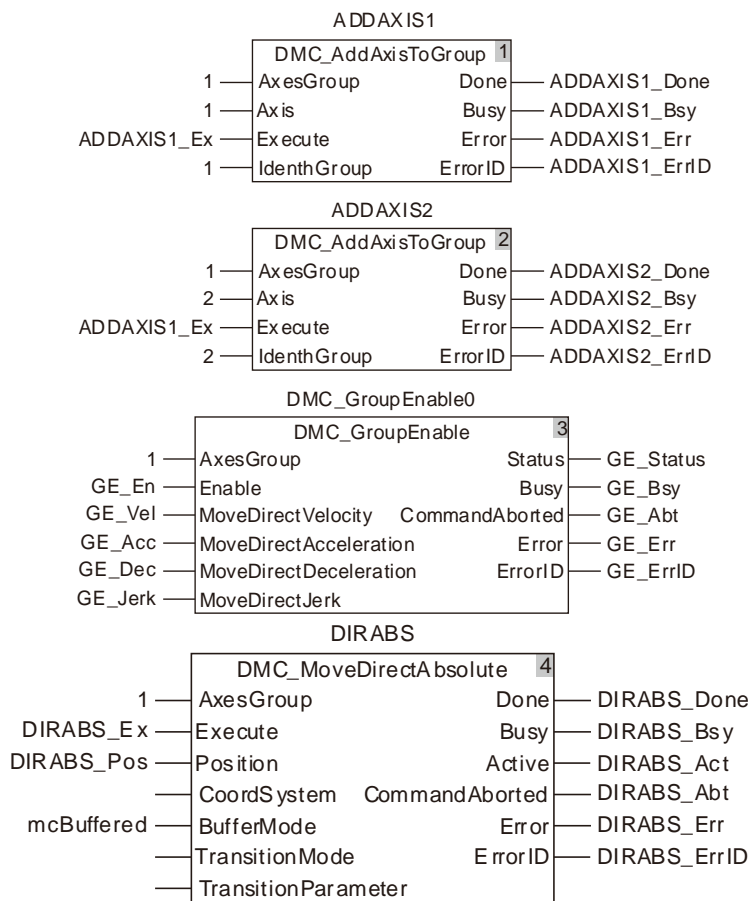

2. X axis-Y axis Motion Curve and Timing Chart

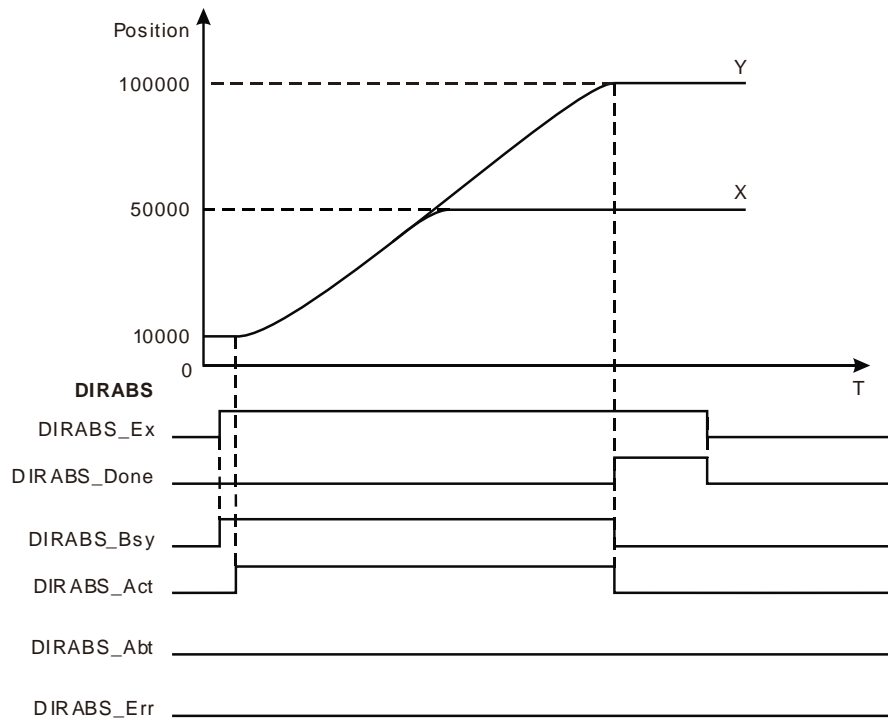

- ❖ The start positions of X axis and Y axis are both 10,000. The inputs DIRABS_Pos[1] and DIRABS_Pos[2] of DMC_MoveDirectAbsolute are set to 50,000 and 100,000 respectively.
- ❖ When DIRABS_Ex changes to TRUE, DIRABS_Bsy changes to TRUE. Two cycles later, DIRABS_Act changes to TRUE and the axes group starts to run.
- ❖ X axis and Y axis are operating according to the set velocities, accelerations and decelerations of DMC_GroupEnable. When X axis moves to 50,000, X axis stops running. At the moment, Y axis keeps going. When Y axis gets to 100,000, the instruction execution is completed.

11.7.9 DMC_MoveDirectRelative

FB/FC	Explanation	Applicable model
FB	DMC_MoveDirectRelative is used to control the axes in an axes group to move corresponding distances from current positions at specified velocities.	DVP15MC11T DVP15MC11T-06

11

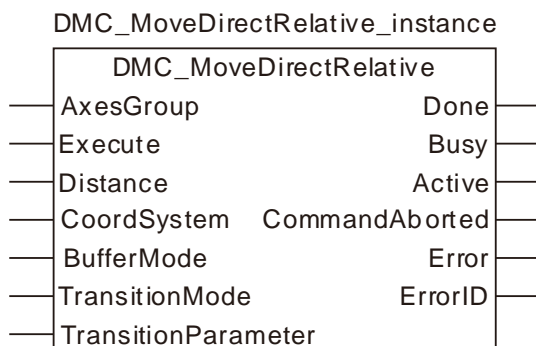

● Input Parameters

Parameter name	Function	Data type	Valid range	Parameter name
AxesGroup	The axes group number	USINT	1~8 (The variable value must be set)	When <i>Execute</i> changes from FALSE to TRUE.
Execute	The instruction is executed when <i>Execute</i> changes from FALSE to TRUE.	BOOL	TRUE or FALSE (FALSE)	
Distance	Set the distances that axes move	ARRAY [1..8] OF LREAL	Positive number, 0, negative number (0)	When <i>Execute</i> changes from FALSE to TRUE.
CoordSystem	Reserved			
BufferMode	Specify the buffer mode between two axes group instructions 1 : Buffered	MC_Buffer_Mode	1: mcBuffered	When <i>Execute</i> changes from FALSE to TRUE.
TransitionMode	Specify the transition mode between two axes group instructions 0 : No transition curve insert	MC_Transition_Mode	0: mcTMNone	When <i>Execute</i> changes from FALSE to TRUE.
TransitionParameter	Set the transition parameter for specific transition mode	LREAL	Positive number, 0 (0)	When <i>Execute</i> changes from FALSE to TRUE.

Note:

1. The execution of DMC_MoveDirectRelative instruction starts when *Execute* changes from FALSE to TRUE. Changing *Execute* from TRUE to FALSE during the instruction execution will have no impact on the instruction execution.
2. The value of input parameter Distance[1] ~ Distance[8] means the motion distances from start

- positions to end positions for axes.
3. The input *BufferMode* of DMC_MoveDirectRelative only supports mcBuffered mode. If other mode is selected, an error will occur when the instruction is executed. For details on BufferMode, refer to section 10.3.
 4. The input *TransitionMode* of DMC_MoveDirectRelative only supports mcTMNone mode. If other mode is selected, an error will occur when the instruction is executed.
 5. The value of the input *TransitionParameter* of DMC_MoveDirectRelative instruction is invalid.

● Output Parameters

Parameter name	Function	Data type	Valid range
Done	TRUE when the instruction execution is completed.	BOOL	TRUE / FALSE
Busy	TRUE when the instruction is being executed.	BOOL	TRUE / FALSE
Active	TRUE when the instruction is controlling axes.	BOOL	TRUE / FALSE
CommandAborted	TRUE when the instruction execution is aborted.	BOOL	TRUE / FALSE
Error	TRUE when an error occurs in execution of the instruction.	BOOL	TRUE / FALSE
ErrorID	Contains the error code when an error occurs. Please refer to section 12.2.	WORD	

● Output Update Timing

Name	Timing for changing to TRUE	Timing for changing to FALSE
Done	◆ When the end positions are reached.	◆ When <i>Execute</i> changes from TRUE to FALSE after the instruction execution is completed ◆ <i>Done</i> changes to TRUE when the instruction execution is completed after <i>Execute</i> changes from TRUE to FALSE during the instruction execution. One cycle later, <i>Done</i> changes to FALSE.
Busy	◆ When <i>Execute</i> changes to TRUE	◆ When <i>Done</i> changes to TRUE ◆ When <i>Error</i> changes to TRUE ◆ When <i>CommandAbort</i> changes to TRUE
Active	◆ When the instruction starts controlling axes.	◆ When <i>Done</i> changes to TRUE ◆ When <i>Error</i> changes to TRUE ◆ When <i>CommandAbort</i> changes to TRUE
CommandAbort	◆ When the instruction execution is aborted by other motion instruction.	◆ When <i>Execute</i> changes from TRUE to FALSE
Error	◆ When an error occurs in the instruction execution or the input parameters for the instruction are illegal.	◆ When <i>Execute</i> changes from TRUE to FALSE

● **Output Update Timing Chart**

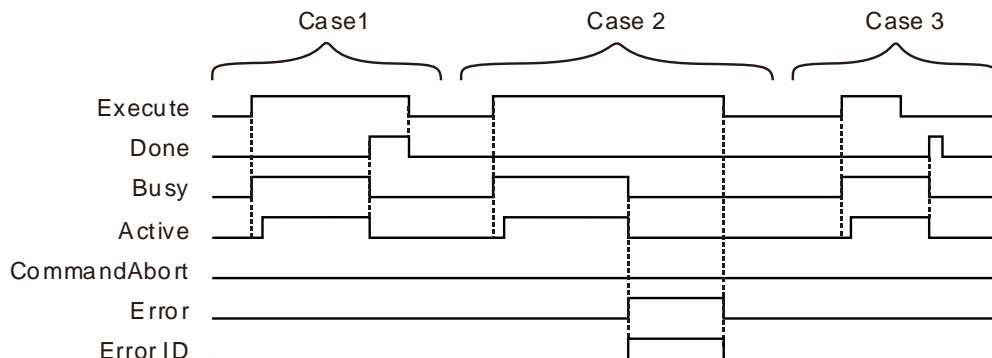

Case 1 : When *Execute* changes from FALSE to TRUE, *Busy* changes to TRUE. Two cycles later, *Active* changes to TRUE. When the axes group reaches the end position, *Done* changes to TRUE, *Busy* and *Active* change to FALSE.

Case 2 : When *Execute* changes from FALSE to TRUE and an error occurs (such as error in state machine of the axes group), *Error* changes to TRUE and *ErrorID* shows corresponding error codes and meanwhile *Busy* and *Active* change to FALSE. When *Execute* changes from TRUE to FALSE, *Error* changes to FALSE.

Case 3 : After *Execute* changes from TRUE to FALSE in the instruction execution, *Done* changes to TRUE when the instruction execution is completed. Meantime *Busy* and *Active* change to FALSE. One cycle later, *Done* changes to FALSE.

● **Function**

DMC_MoveDirectRelative is used for an axes group to conduct quick positioning and one or more axes in the axes group can be controlled. The firmware of V1.01 and above supports the function. Axes are relatively independent with each other during the motion. The velocities, accelerations, decelerations and jerks of axes depend on the input values of DMC_GroupEnable: MoveDirectVelocity, MoveDirectAcceleration, MoveDirectDeceleration and MoveDirectJerk.



Programming Example

The example in which one DMC_MoveDirectRelative instruction is executed is as follows.

1. The variable table and program

Variable name	Data type	Initial value
ADDAXIS1	DMC_AddAxisToGroup	
ADDAXIS1_Ex	BOOL	
ADDAXIS1_Done	BOOL	
ADDAXIS1_Bsy	BOOL	
ADDAXIS1_Err	BOOL	
ADDAXIS1_ErrID	WORD	
ADDAXIS2	DMC_AddAxisToGroup	
ADDAXIS2_Done	BOOL	
ADDAXIS2_Bsy	BOOL	
ADDAXIS2_Err	BOOL	
ADDAXIS2_ErrID	WORD	
DMC_GroupEnable0	DMC_GroupEnable	
GE_En	BOOL	

Variable name	Data type	Initial value
GE_Vel	ARRAY [1..8] OF LREAL	
GE_Acc	ARRAY [1..8] OF LREAL	
GE_Dec	ARRAY [1..8] OF LREAL	
GE_Jerk	ARRAY [1..8] OF LREAL	
GE_Status	BOOL	
GE_Bsy	BOOL	
GE_Abt	BOOL	
GE_Err	BOOL	
GE_ErrID	WORD	
DIRREL	DMC_MoveDirectRelative	
DIRREL_Ex	BOOL	
DIRREL_Dis	ARRAY [1..8] OF LREAL	
DIRREL_Done	BOOL	
DIRREL_Bsy	BOOL	
DIRREL_Act	BOOL	
DIRREL_Abt	BOOL	
DIRREL_Err	BOOL	
DIRREL_ErrID	WORD	

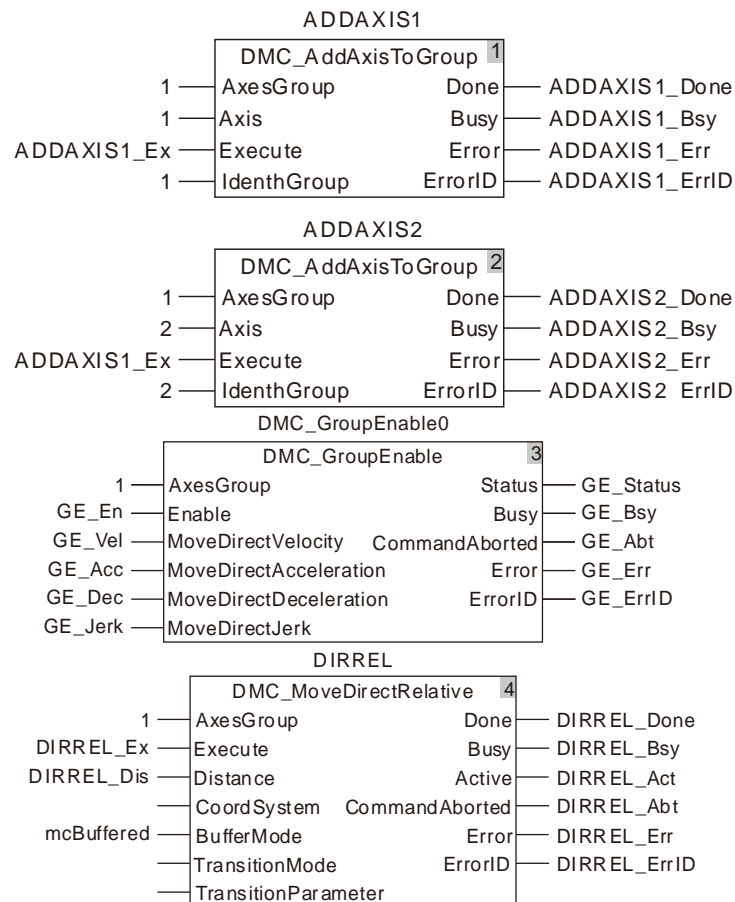

2. X axis-Y axis Motion Curve and Timing Chart

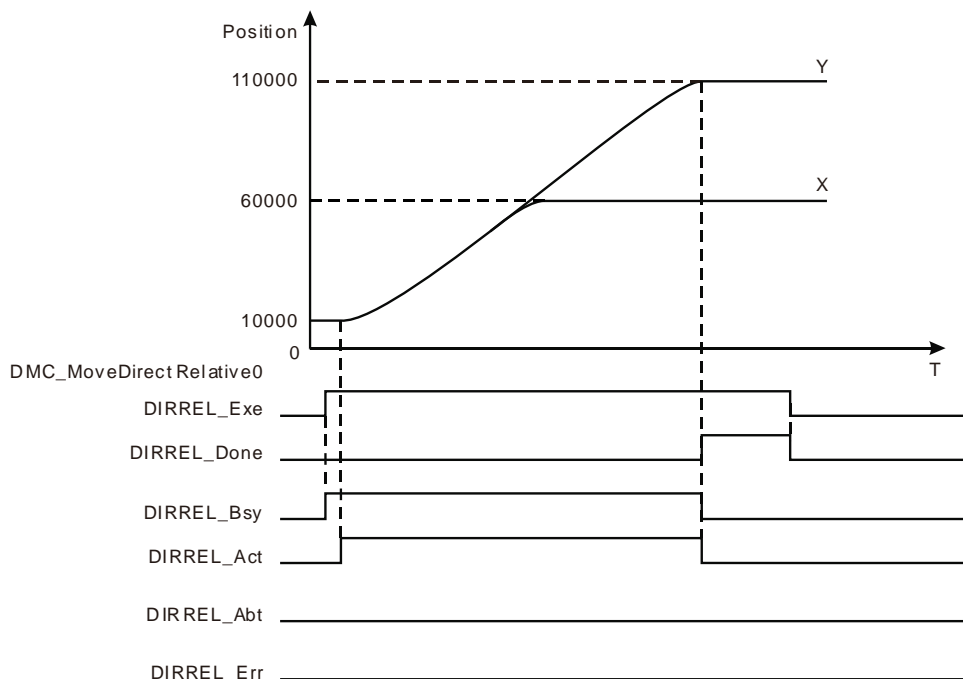

- ❖ The start positions of X axis and Y axis are both 10,000. The inputs DIRREL_Dis[1] and DIRREL_Dis[2] of DMC_MoveDirectRelative are set to 50,000 and 100,000 respectively.
- ❖ When DIRREL_Ex changes to TRUE, DIRREL_Bsy changes to TRUE. Two cycles later, DIRREL_Act changes to TRUE and the axes group starts to run.
- ❖ X axis and Y axis are operating according to the set velocities, accelerations and decelerations of DMC_GroupEnable. When X axis moves to 60,000, the axis stops running. At the moment, Y axis keeps going. When Y axis gets to 110,000, the instruction execution is completed.

11.7.10 DMC_MoveLinearAbsolute

FB/FC	Explanation	Applicable model
FB	DMC_MoveLinearAbsolute controls axes to perform the linear interpolation motion. The end positions of axes are absolute positions.	DVP15MC11T DVP15MC11T-06

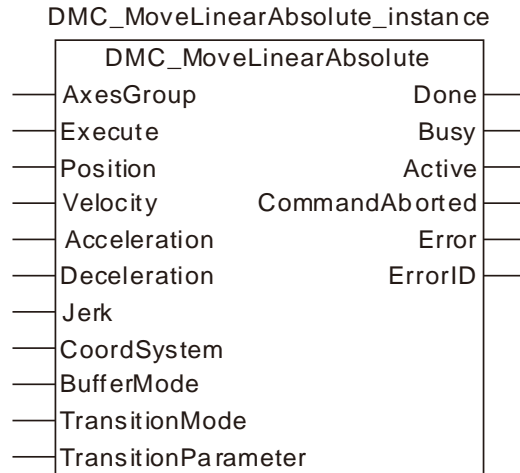

● Input Parameters

Parameter name	Function	Data type	Valid range (Default)	Validation timing
AxesGroup	The axes group number	USINT	1~8 (The variable value must be set)	When <i>Execute</i> changes from FALSE to TRUE.
Execute	The instruction is executed when <i>Execute</i> changes from FALSE to TRUE.	BOOL	TRUE or FALSE (FALSE)	
Position	Specify end positions for linear interpolation	ARRAY [1..8] OF LREAL	Negative number, Positive number, 0, (0)	When <i>Execute</i> changes from FALSE to TRUE.
Velocity	Set the maximum resultant velocity. (Unit: Unit/second)	LREAL	Positive number (0)	When <i>Execute</i> changes from FALSE to TRUE.
Acceleration	Set the maximum resultant acceleration (Unit: Unit/second ²)	LREAL	Positive number (0)	When <i>Execute</i> changes from FALSE to TRUE.
Deceleration	Set the maximum resultant deceleration (Unit: Unit/second ²)	LREAL	Positive number (0)	When <i>Execute</i> changes from FALSE to TRUE.
Jerk	Set the maximum resultant jerk (Unit: Unit/second ³)	LREAL	Positive number (0)	When <i>Execute</i> changes from FALSE to TRUE.
CoordSystem	Reserved			
BufferMode	Specify the buffer mode between two	MC_Buffer_Mode	1: mcBuffered	When <i>Execute</i> changes from

Parameter name	Function	Data type	Valid range (Default)	Validation timing
	axes group instructions 1: Buffered 3: Blended with the speed of previous instruction		3: mcBlending-Previous	FALSE to TRUE.
TransitionMode	Specify the transition mode between two axes group instructions 0: No transition curve inserted 2: Make the transition at the set constant speed 3: Make the transition based on the specified corner distance	MC_Transition_Mode	0: mcTMNone 2: mcTMConstantVelocity 3: mcTMCornerDistance	When <i>Execute</i> changes from FALSE to TRUE.
TransitionParameter	Set the transition parameter for specific transition mode	LREAL	Positive number, 0 (0)	When <i>Execute</i> changes from FALSE to TRUE.

Note:

1. DMC_MoveLinearAbsolute instruction starts being executed when *Execute* changes from FALSE to TRUE. Changing *Execute* from TRUE to FALSE during the instruction execution will have no impact on the instruction execution.
2. The value of input parameter Position[1] ~ Position[8] means the end positions for linear interpolation.
3. Refer to section 10.2 for the relationship among Velocity, Acceleration, Deceleration and Jerk .
4. For details on BufferMode, refer to section 10.3.
5. The value of the input *TransitionParameter* of DMC_MoveLinearAbsolute instruction is invalid unless mcTMCornerDistance is selected as TransitionMode.

● **Output Parameters**

Parameter name	Function	Data type	Valid range
Done	TRUE when the instruction execution is completed.	BOOL	TRUE / FALSE
Busy	TRUE when the instruction is being executed.	BOOL	TRUE / FALSE
Active	TRUE when the instruction is controlling axes.	BOOL	TRUE / FALSE
CommandAborted	TRUE when the instruction execution is aborted.	BOOL	TRUE / FALSE
Error	TRUE when an error occurs in execution of the instruction.	BOOL	TRUE / FALSE
ErrorID	Contains the error code when an error occurs. Please refer to section 12.2.	WORD	

- **Output Update Timing**

Name	Timing for changing to TRUE	Timing for changing to FALSE
Done	◆ When the end positions are reached.	◆ When <i>Execute</i> changes from TRUE to FALSE after the instruction execution is completed ◆ <i>Done</i> changes to TRUE when the instruction execution is completed after <i>Execute</i> changes from TRUE to FALSE during the instruction execution. One cycle later, <i>Done</i> changes to FALSE.
Busy	◆ When <i>Execute</i> changes to TRUE.	◆ When <i>Done</i> changes to TRUE ◆ When <i>Error</i> changes to TRUE ◆ When <i>CommandAbort</i> changes to TRUE
Active	◆ When axes start being controlled by the instruction.	◆ When <i>Done</i> changes to TRUE ◆ When <i>Error</i> changes to TRUE ◆ When <i>CommandAbort</i> changes to TRUE
CommandAbort	◆ When the instruction execution is aborted by other motion instruction.	◆ When <i>Execute</i> changes from TRUE to FALSE
Error	◆ When an error occurs in the instruction execution or the input parameters for the instruction are illegal.	◆ When <i>Execute</i> changes from TRUE to FALSE

- **Output Update Timing Chart**

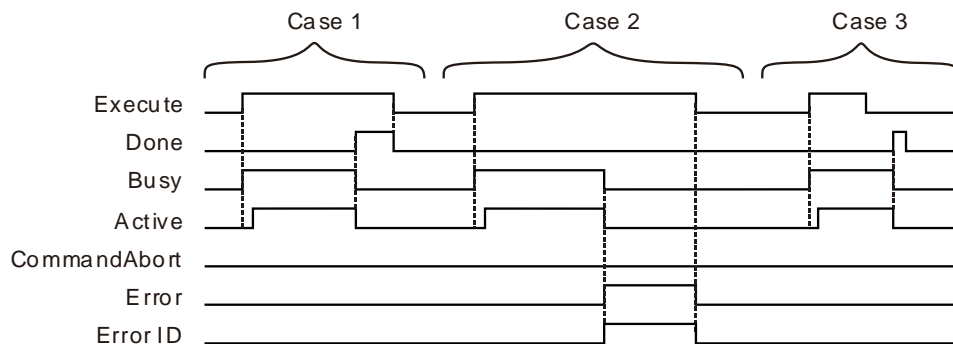

Case 1 : When *Execute* changes from FALSE to TRUE, *Busy* changes to TRUE. Two cycles later, *Active* changes to TRUE. When the axes group reaches the end position, *Done* changes to TRUE, *Busy* and *Active* change to FALSE.

Case 2 : When *Execute* changes from FALSE to TRUE and an error occurs (such as error in state machine of the axes group), *Error* changes to TRUE and *ErrorID* shows corresponding error codes and meanwhile *Busy* and *Active* change to FALSE. When *Execute* changes from TRUE to FALSE, *Error* changes to FALSE.

Case 3 : After *Execute* changes from TRUE to FALSE in the instruction execution, *Done* changes to TRUE when the instruction execution is completed. Meantime *Busy* and *Active* change to FALSE. One cycle later, *Done* changes to FALSE.

- **Function**

1. DMC_MoveLinearAbsolute is used for an axes group to conduct linear interpolation and one or more axes in the axes group can be controlled. The firmware of V1.01 and above supports the function.

The input *Velocity* of DMC_MoveLinearAbsolute is the target velocity of the terminal actuator. The velocity of the terminal actuator and velocities of axes have the following relationship.

Square of terminal actuator’s velocity= Sum of squares of velocities of axes

The inputs *Acceleration* and *Deceleration* of DMC_MoveLinearAbsolute are the target acceleration and target deceleration of the terminal actuator. The acceleration and deceleration of the terminal actuator and acceleration and deceleration of axes have the following relationship.

Terminal actuator’s acceleration(deceleration)= Sum of squares of acceleration(deceleration) of axes

2. The *Jerk* of DMC_MoveLinearAbsolute instruction is reserved.
3. See the relationship among *BufferMode*, *TransitionMode* and *TransitionParameter* as follows. If mcBuffered is selected as *BufferMode*, *TransitionMode* supports mcTMNone only. If mcBlendingPrevious is selected as *BufferMode*, *TransitionMode* supports the two modes: mcTMConstantVelocity and mcTMCornerDistance.

BufferMode value	TransitionMode value	Description
mcBuffered(1)	mcTMNone(0)	Wait until the previous interpolation instruction execution is finished and then execute current instruction immediately.
mcBlending-Previous(3)	mcTMConstant-Velocity(2)	Smooth transition: Wait till the previous interpolation instruction execution is completed and then execute current instruction immediately. The transition velocity is the resultant velocity of the previous instruction. After the instruction switch, the terminal actuator conducts the smooth transition and then makes the linear motion as illustrated in the following example 2.
	mcTMCorner-Distance(3)	Corner-distance transition: Wait till the previous interpolation instruction execution is completed and then execute current instruction immediately. When the distance between the terminal actuator position and the final position of the previous interpolation instruction equals the value of <i>TransitionParameter</i> during the execution of the previous interpolation instruction, the previous interpolation instruction execution is completed immediately and then current instruction execution starts. During the execution of the current instruction, the terminal actuator moves for a circular path and then makes a linear interpolation. The distance between the end point of the circular arc and the end point of the previous interpolation instruction is still equal to the value of <i>TransitionParameter</i> as illustrated in the following example 3.



Programming Example 1

The example in which one DMC_MoveLinearAbsolute instruction is executed is as follows.

1. The variable table and program

Variable name	Data type	Initial value
ADDAXIS1	DMC_AddAxisToGroup	
ADDAXIS1_Ex	BOOL	
ADDAXIS1_Done	BOOL	
ADDAXIS1_Bsy	BOOL	
ADDAXIS1_Err	BOOL	
ADDAXIS1_ErrID	WORD	
ADDAXIS 2	DMC_AddAxisToGroup	

Variable name	Data type	Initial value
ADDAXIS2_Done	BOOL	
ADDAXIS2_Bsy	BOOL	
ADDAXIS2_Err	BOOL	
ADDAXIS2_ErrID	WORD	
ADDAXIS3	DMC_AddAxisToGroup	
ADDAXIS3_Done	BOOL	
ADDAXIS3_Bsy	BOOL	
ADDAXIS3_Err	BOOL	
ADDAXIS3_ErrID	WORD	
DMC_GroupEnable0	DMC_GroupEnable	
GE_En	BOOL	
GE_Vel	ARRAY [1..8] OF LREAL	
GE_Acc	ARRAY [1..8] OF LREAL	
GE_Dec	ARRAY [1..8] OF LREAL	
GE_Jerk	ARRAY [1..8] OF LREAL	
GE_Status	BOOL	
GE_Bsy	BOOL	
GE_Abt	BOOL	
GE_Err	BOOL	
GE_ErrID	WORD	
LINABS	DMC_MoveLinearAbsolute	
LINABS_Ex	BOOL	
LINABS_Pos	ARRAY [1..8] OF LREAL	
LINABS_Done	BOOL	
LINABS_Bsy	BOOL	
LINABS_Act	BOOL	
LINABS_Abt	BOOL	
LINABS_Err	BOOL	
LINABS_ErrID	WORD	

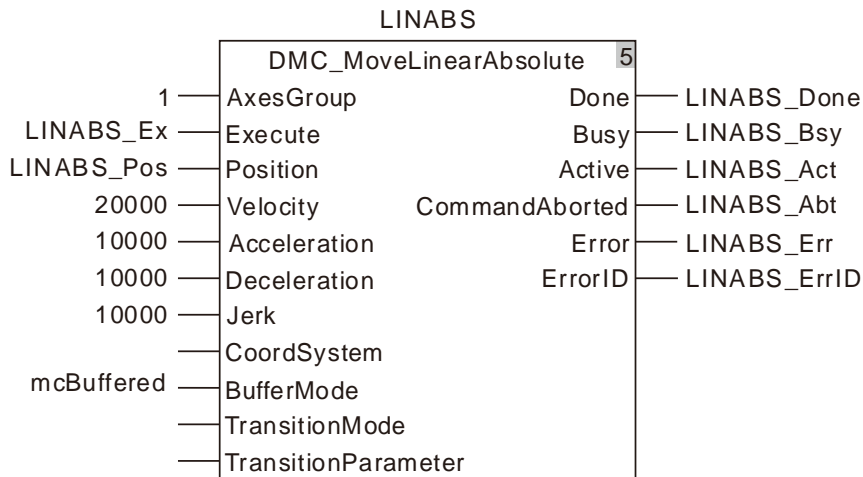
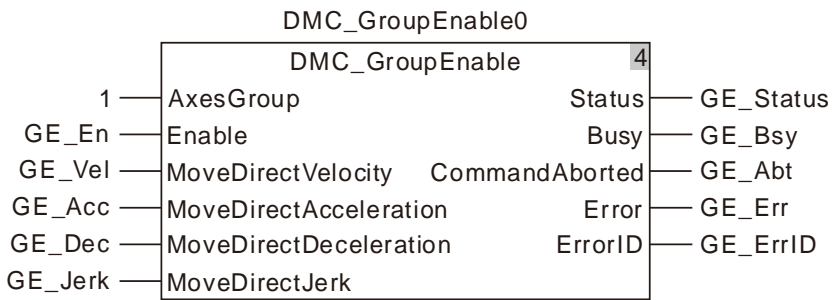
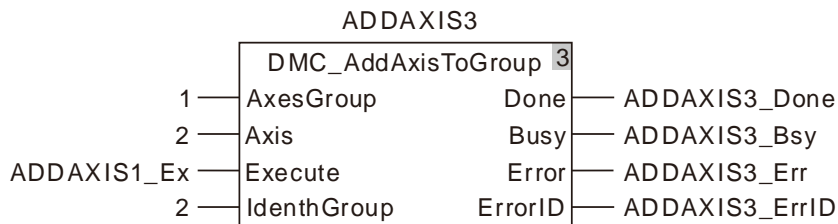
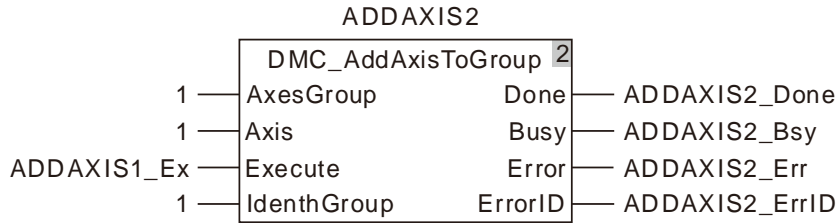
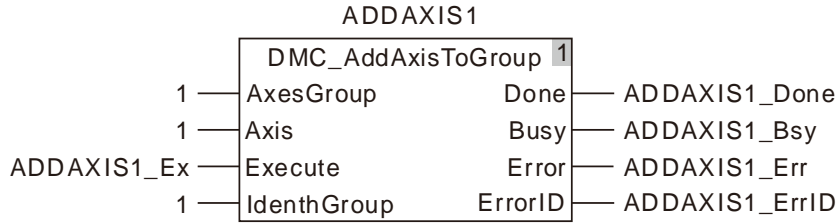

2. See the entire motion process after the instruction is executed.

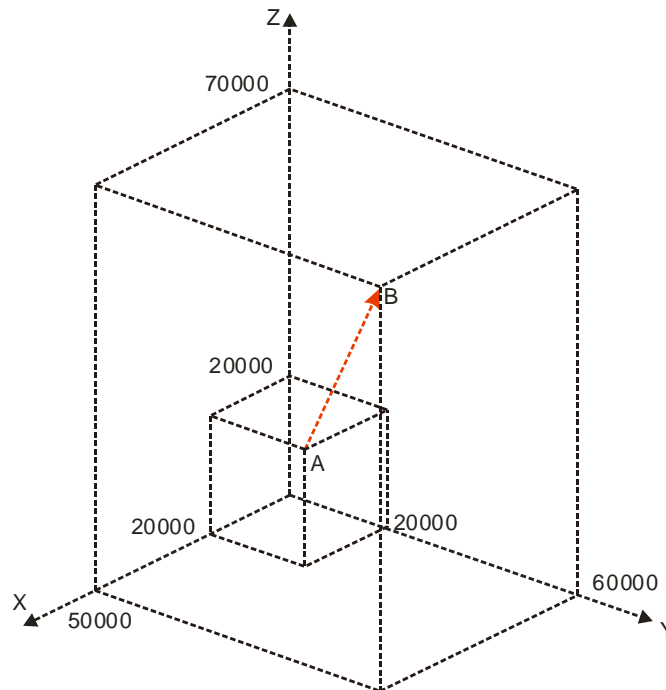

3. X axis-Y axis-Z axis Motion Curve and Timing Chart

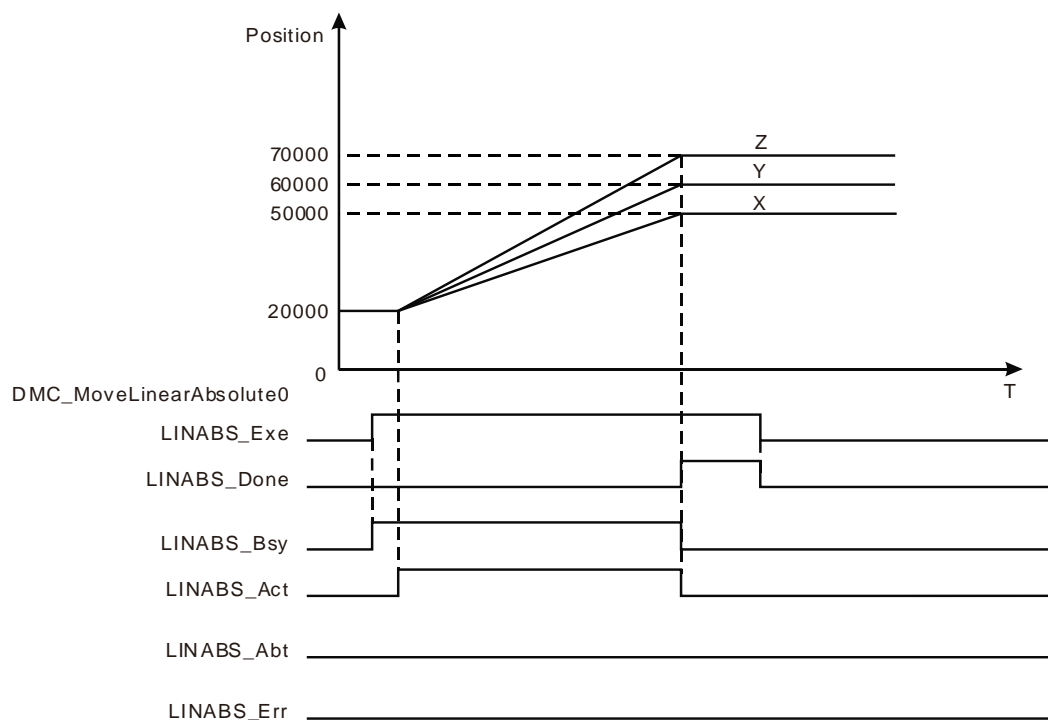

- ❖ The start positions of X axis, Y axis and Z axis are all 20,000. `LINABS_Pos[1]`, `LINABS_Pos[2]` and `LINABS_Pos[3]` of `DMC_MoveLinearAbsolute` are set to 50,000, 60,000 and 70,000 respectively.
- ❖ When `LINABS_Exe` changes to TRUE, `LINABS_Bsy` changes to TRUE. Two cycles later, `LINABS_Act` changes to TRUE and the axes group starts to run.
- ❖ X axis, Y axis and Z axis reach respective target positions simultaneously, `LINABS_Done` changes to TRUE and `LINABS_Bsy` and `LINABS_Act` change to FALSE when the execution of

DMC_MoveLinearAbsolute instruction is completed.



Programming Example 2

The example in which there are two DMC_MoveLinearAbsolute instructions and the transition mode between them is mcTMConstantVelocity is as follows.

1. The variable table and program

Variable name	Data type	Initial value
ADDAXIS1	DMC_AddAxisToGroup	
ADDAXIS1_Ex	BOOL	
ADDAXIS1_Done	BOOL	
ADDAXIS1_Bsy	BOOL	
ADDAXIS1_Err	BOOL	
ADDAXIS1_ErrID	WORD	
ADDAXIS2	DMC_AddAxisToGroup	
ADDAXIS2_Done	BOOL	
ADDAXIS2_Bsy	BOOL	
ADDAXIS2_Err	BOOL	
ADDAXIS2_ErrID	WORD	
DMC_GroupEnable0	DMC_GroupEnable	
GE_En	BOOL	
GE_Vel	ARRAY [1..8] OF LREAL	
GE_Acc	ARRAY [1..8] OF LREAL	
GE_Dec	ARRAY [1..8] OF LREAL	
GE_Jerk	ARRAY [1..8] OF LREAL	
GE_Status	BOOL	
GE_Bsy	BOOL	
GE_Abt	BOOL	
GE_Err	BOOL	
GE_ErrID	WORD	
LINABS1	DMC_MoveLinearAbsolute	
LINABS1_Ex	BOOL	
LINABS1_Pos	ARRAY [1..8] OF LREAL	
LINABS1_Done	BOOL	
LINABS1_Bsy	BOOL	
LINABS1_Act	BOOL	
LINABS1_Abt	BOOL	
LINABS1_Err	BOOL	
LINABS1_ErrID	WORD	
LINABS2	DMC_MoveLinearAbsolute	
LINABS2_Pos	ARRAY [1..8] OF LREAL	

Variable name	Data type	Initial value
LINABS2_Done	BOOL	
LINABS2_Bsy	BOOL	
LINABS2_Act	BOOL	
LINABS2_Abt	BOOL	
LINABS2_Err	BOOL	
LINABS2_ErrID	WORD	

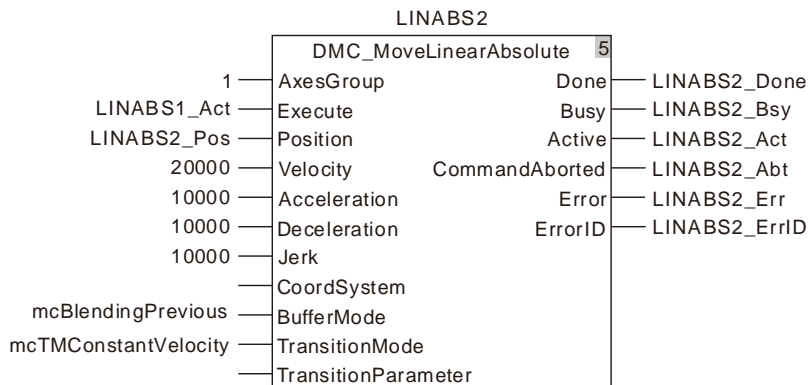
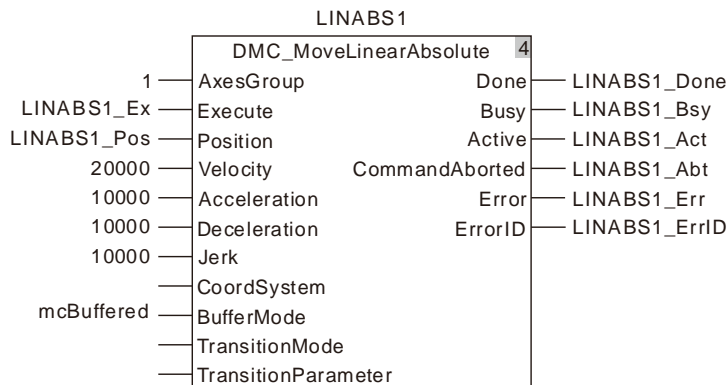
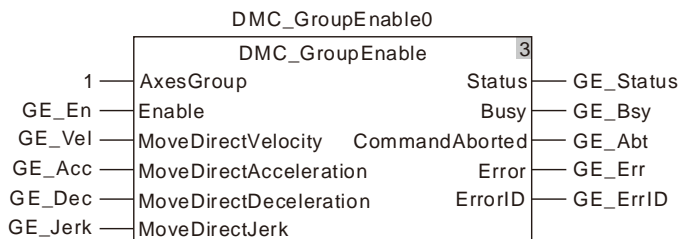
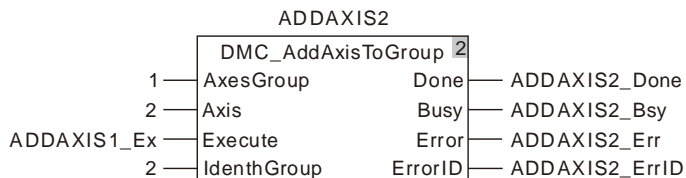
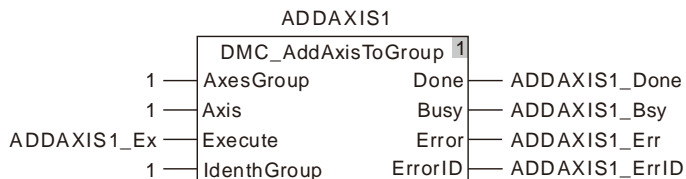

2. See the motion curve and timing chart of the terminal actuator.

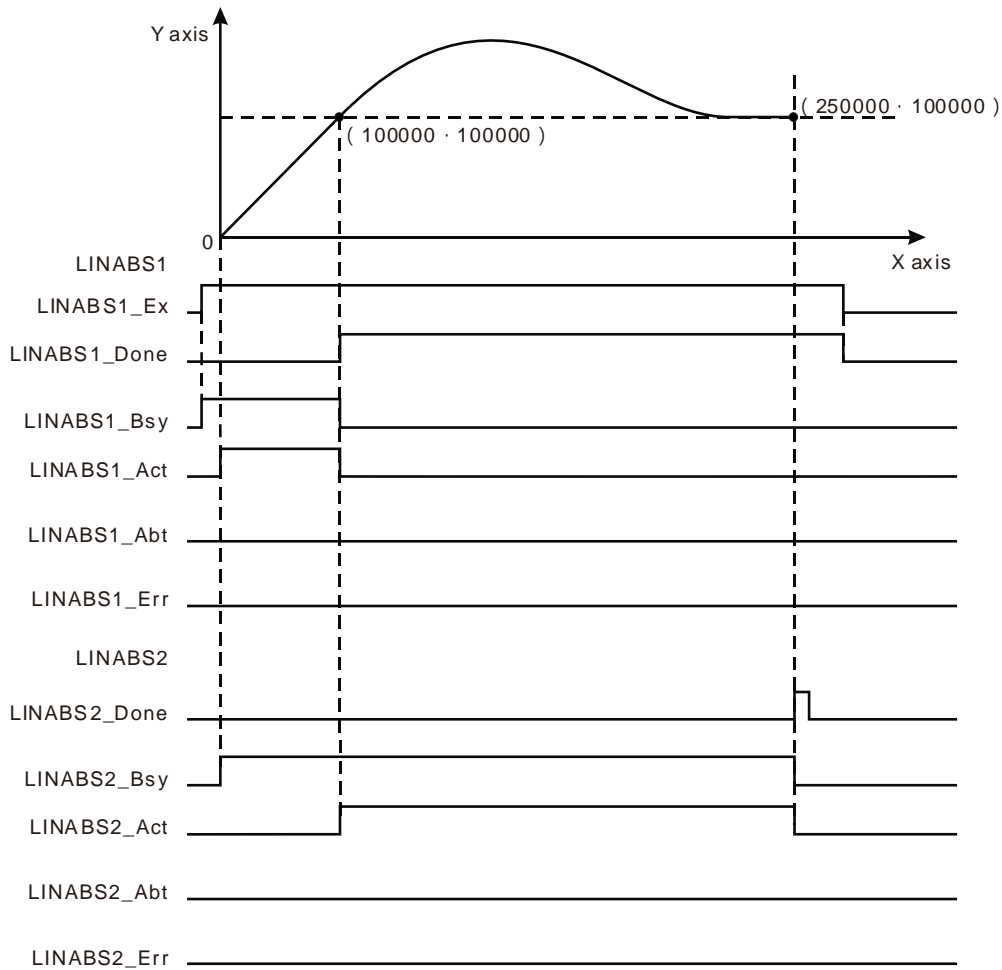

- ❖ Set BufferMode to mcBlendingPrevious and TransitionMode to mcTMConstantVelocity for LINABS2.
- ❖ The values of LINABS1_Pos [1] and LINABS1_Pos [2] of LINABS1 are both set to 100,000. And the values of LINABS2_Pos [1] and LINABS2_Pos [2] of LINABS2 are set to 250,000 and 100,000 respectively.
- ❖ ADDAXIS1 and ADDAXIS2 are executed first and then DMC_GroupEnable0 is executed. When the axes group is enabled, LINABS1 is executed and then LINABS2 is executed immediately.
- ❖ When the terminal actuator gets to the coordinates (100,000, 100,000), LINABS1_Done changes to TRUE. Meanwhile LINABS2_Act changes to TRUE and LINABS2 starts to execute. At the moment, the speed of the terminal actuator is the target speed 20,000 of the previous instruction.
- ❖ The terminal actuator conducts the smooth transition and then makes a linear motion after LINABS2 is executed. The instruction execution is completed once the terminal actuator reaches the coordinates (250,000, 100,000).



Programming Example 3

The example in which there are two DMC_MoveLinearAbsolute instructions and the transition mode between them is mcTMCornerDistance is as follows.

1. The variable table and program

Variable name	Data type	Initial value
ADDAXIS1	DMC_AddAxisToGroup	
ADDAXIS1_Ex	BOOL	
ADDAXIS1_Done	BOOL	
ADDAXIS1_Bsy	BOOL	
ADDAXIS1_Err	BOOL	
ADDAXIS1_ErrID	WORD	
ADDAXIS2	DMC_AddAxisToGroup	
ADDAXIS2_Done	BOOL	
ADDAXIS2_Bsy	BOOL	
ADDAXIS2_Err	BOOL	
ADDAXIS2_ErrID	WORD	
DMC_GroupEnable0	DMC_GroupEnable	
GE_En	BOOL	
GE_Vel	ARRAY [1..8] OF LREAL	
GE_Acc	ARRAY [1..8] OF LREAL	
GE_Dec	ARRAY [1..8] OF LREAL	
GE_Jerk	ARRAY [1..8] OF LREAL	
GE_Status	BOOL	
GE_Bsy	BOOL	
GE_Abt	BOOL	
GE_Err	BOOL	
GE_ErrID	WORD	
LINABS1	DMC_MoveLinearAbsolute	
LINABS1_Ex	BOOL	
LINABS1_Pos	ARRAY [1..8] OF LREAL	
LINABS1_Done	BOOL	
LINABS1_Bsy	BOOL	
LINABS1_Act	BOOL	
LINABS1_Abt	BOOL	
LINABS1_Err	BOOL	
LINABS1_ErrID	WORD	
LINABS2	DMC_MoveLinearAbsolute	
LINABS2_Pos	ARRAY [1..8] OF LREAL	
LINABS2_Done	BOOL	
LINABS2_Bsy	BOOL	
LINABS2_Act	BOOL	
LINABS2_Abt	BOOL	
LINABS2_Err	BOOL	
LINABS2_ErrID	WORD	

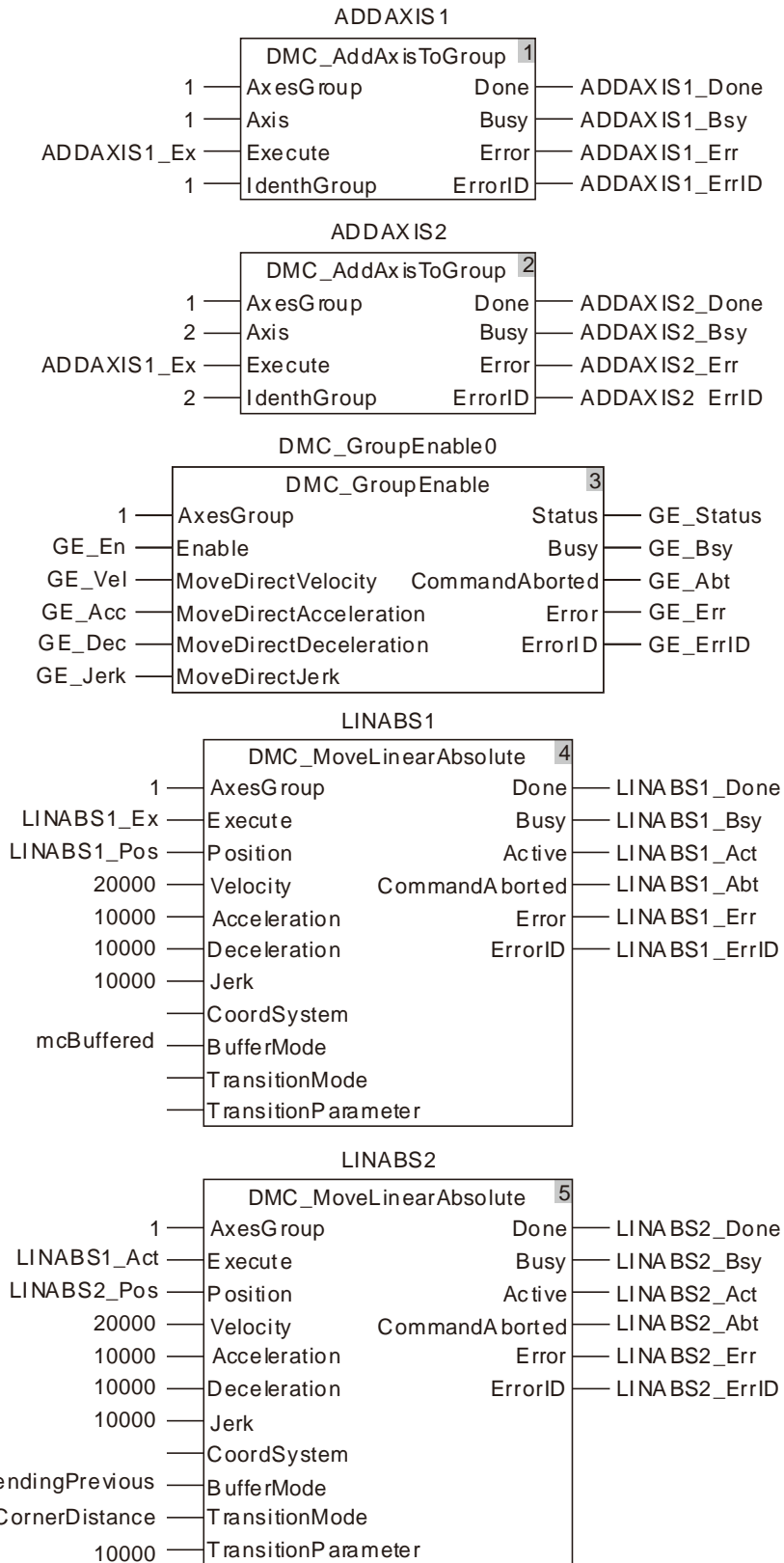

2. See the motion curve and timing chart of the terminal actuator.

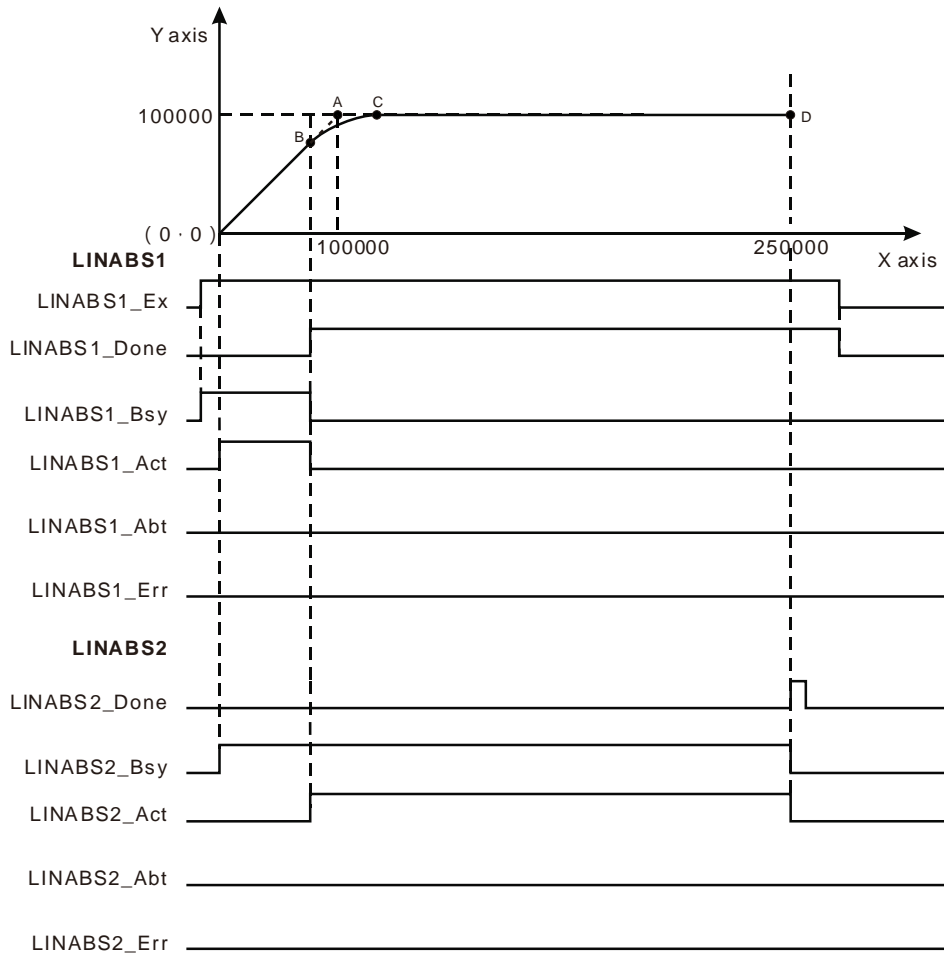

- ❖ Set `BufferMode` to `mcBlendingPrevious`, `TransitionMode` to `mcTMCornerDistance` and `TransitionParameter` to 10000 for LINABS2.
- ❖ The values of `LINABS1_Pos [1]` and `LINABS1_Pos [2]` of LINABS1 are both set to 100,000. And the values of `LINABS2_Pos [1]` and `LINABS2_Pos [2]` of LINABS2 are set to 250,000 and 100,000 respectively.
- ❖ `ADDAXIS1` and `ADDAXIS2` are executed first and then `DMC_GroupEnable0` is executed. When the axes group is enabled, LINABS1 is executed and then LINABS2 is executed immediately.
- ❖ When the terminal actuator gets to point B in the coordinate system, `LINABS1_Done` changes to TRUE. Meanwhile `LINABS2_Act` changes to TRUE and LINABS2 starts to execute.
- ❖ After LINABS2 is executed, the terminal actuator moves along an arc path till it reaches point C. Afterward it continues to make the linear interpolation.
- ❖ The distance from point B to point A equals that from point C to point A. It is also equal to 10,000, the value of the input `TransitionParameter` of LINABS2.

11.7.11 DMC_MoveLinearRelative

FB/FC	Explanation	Applicable model
FB	DMC_MoveLinearRelative controls axes to perform the linear interpolation motion. The end positions of axes are relative positions.	DVP15MC11T DVP15MC11T-06

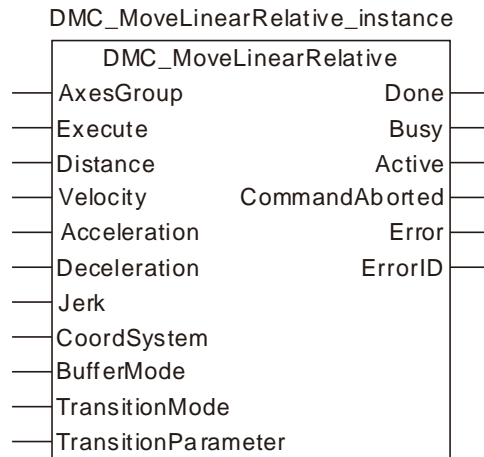

● **Input Parameters**

Parameter name	Function	Data type	Valid range (Default)	Validation timing
AxesGroup	The axes group number	USINT	1~8 (The variable value must be set)	When <i>Execute</i> changes from FALSE to TRUE.
Execute	The instruction is executed when <i>Execute</i> changes from FALSE to TRUE.	BOOL	TRUE or FALSE (FALSE)	
Distance	Set the distances that axes move	ARRAY [1..8] OF LREAL	Negative number, Positive number, 0, (0)	When <i>Execute</i> changes from FALSE to TRUE.
Velocity	Set the maximum resultant velocity. (Unit: Unit/second)	LREAL	Positive (0)	When <i>Execute</i> changes from FALSE to TRUE.
Acceleration	Set the maximum resultant acceleration (Unit: Unit/second ²)	LREAL	Positive (0)	When <i>Execute</i> changes from FALSE to TRUE.
Deceleration	Set the maximum resultant deceleration (Unit: Unit/second ²)	LREAL	Positive (0)	When <i>Execute</i> changes from FALSE to TRUE.
Jerk	Set the maximum resultant jerk (Unit: Unit/second ³)	LREAL	Positive (0)	When <i>Execute</i> changes from FALSE to TRUE.
CoordSystem	Reserved			
BufferMode	Specify the buffer mode	MC_Buffer_	1: mcBuffered	When <i>Execute</i>

Parameter name	Function	Data type	Valid range (Default)	Validation timing
	between two axes group instructions 1: Buffered 3: Blended with the speed of previous instruction	Mode	3: mcBlending-Previous	changes from FALSE to TRUE.
TransitionMode	Specify the transition mode between two axes group instructions 0: No transition curve inserted 2: Make the transition at the set constant speed 3: Make the transition based on the specified corner distance	MC_Transition_Mode	0: mcTMNone 2 : mcTMConstantVelocity 3: mcTMCornerDistance	When <i>Execute</i> changes from FALSE to TRUE.
TransitionParameter	Set the transition parameter for specific transition mode	LREAL	Positive, 0 (0)	When <i>Execute</i> changes from FALSE to TRUE.

Note:

1. DMC_MoveLinearRelative instruction starts being executed when *Execute* changes from FALSE to TRUE. Changing *Execute* from TRUE to FALSE during the instruction execution will have no impact on the instruction execution.
2. The value of input parameter Distance[1] ~ Distance[8] means the end positions for linear interpolation.
3. Refer to section 10.2 for the relationship among Velocity, Acceleration, Deceleration and Jerk .
4. For details on BufferMode, refer to section 10.3.
5. The value of the input *TransitionParameter* of DMC_MoveLinearRelative instruction is invalid unless mcTMCornerDistance is selected as TransitionMode .

- **Output Parameters**

Parameter name	Function	Data type	Valid range
Done	TRUE when the instruction execution is completed.	BOOL	TRUE / FALSE
Busy	TRUE when the instruction is being executed.	BOOL	TRUE / FALSE
Active	TRUE when the instruction is controlling axes.	BOOL	TRUE / FALSE
CommandAborted	TRUE when the instruction execution is aborted.	BOOL	TRUE / FALSE
Error	TRUE when an error occurs in execution of the instruction.	BOOL	TRUE / FALSE
ErrorID	Contains the error code when an error occurs. Please refer to section 12.2.	WORD	

● **Output Update Timing**

Name	Timing for changing to TRUE	Timing for changing to FALSE
Done	◆ When the end positions are reached.	◆ When <i>Execute</i> changes from TRUE to FALSE after the instruction execution is completed ◆ <i>Done</i> changes to TRUE when the instruction execution is completed after <i>Execute</i> changes from TRUE to FALSE during the instruction execution. One cycle later, <i>Done</i> changes to FALSE.
Busy	◆ When <i>Execute</i> changes to TRUE.	◆ When <i>Done</i> changes to TRUE ◆ When <i>Error</i> changes to TRUE ◆ When <i>CommandAbort</i> changes to TRUE
Active	◆ When axes start being controlled by the instruction.	◆ When <i>Done</i> changes to TRUE ◆ When <i>Error</i> changes to TRUE ◆ When <i>CommandAbort</i> changes to TRUE
CommandAbort	◆ When the instruction execution is aborted by other motion instruction.	◆ When <i>Execute</i> changes from TRUE to FALSE
Error	◆ When an error occurs in the instruction execution or the input parameters for the instruction are illegal.	◆ When <i>Execute</i> changes from TRUE to FALSE

● **Output Update Timing Chart**

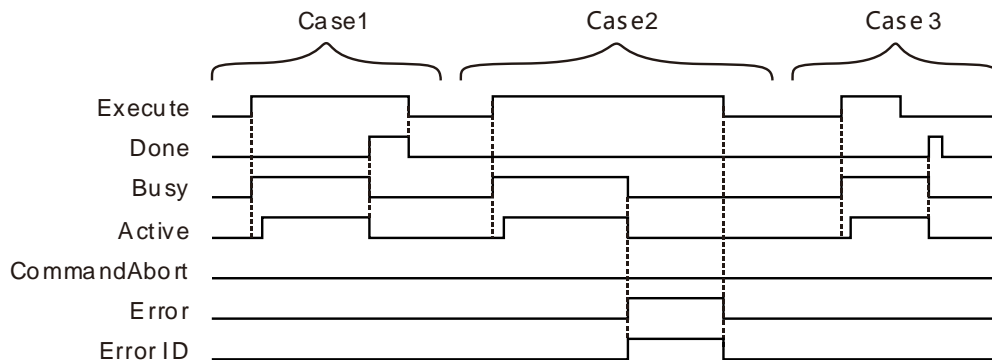

Case 1 : When *Execute* changes from FALSE to TRUE, *Busy* changes to TRUE. Two cycles later, *Active* changes to TRUE. When the axes group reaches the end position, *Done* changes to TRUE, *Busy* and *Active* change to FALSE.

Case 2 : When *Execute* changes from FALSE to TRUE and an error occurs (such as error in state machine of the axes group), *Error* changes to TRUE and *ErrorID* shows corresponding error codes and meanwhile *Busy* and *Active* change to FALSE. When *Execute* changes from TRUE to FALSE, *Error* changes to FALSE.

Case 3 : After *Execute* changes from TRUE to FALSE in the instruction execution, *Done* changes to TRUE when the instruction execution is completed. Meantime *Busy* and *Active* change to FALSE. One cycle later, *Done* changes to FALSE.

● **Function**

DMC_MoveLinearRelative is used for an axes group to conduct linear interpolation and one or more axes in the axes group can be controlled. The firmware of V1.01 and above supports the function.

1. The input *Velocity* of DMC_MoveLinearRelative instruction is the target velocity of the terminal actuator. The velocity of the terminal actuator and velocities of axes have the following relationship.

Square of terminal actuator's velocity= Sum of squares of velocities of axes

The inputs *Acceleration* and *Deceleration* of DMC_MoveLinearRelative are the target acceleration and target deceleration of the terminal actuator. The acceleration and deceleration of the terminal actuator and accelerations and decelerations of axes have the following relationship.

Terminal actuator ' s acceleration (deceleration) = Sum of squares of acceleration (deceleration) of axes

2. The *Jerk* of DMC_MoveLinearRelative instruction is reserved.
3. See the relationship among *BufferMode*, *TransitionMode* and *TransitionParameter* as follows. If mcBuffered is selected as *BufferMode*, *TransitionMode* supports mcTMNone only. If mcBlendingPrevious is selected as *BufferMode*, *TransitionMode* supports the two modes: mcTMConstantVelocity and mcTMCornerDistance.

BufferMode value	TransitionMode value	Description
mcBuffered(1)	mcTMNone(0)	Wait until the previous interpolation instruction execution is finished and then execute current instruction immediately.
mcBlending-Previous(3)	mcTMConstant-Velocity(2)	Smooth transition: Wait till the previous interpolation instruction execution is completed and then execute current instruction immediately. The transition velocity is the resultant velocity of the previous instruction. After the instruction switch, the terminal actuator conducts the smooth transition and then makes the linear motion as illustrated in the following example 2.
	mcTMCorner-Distance(3)	Corner-distance transition: Wait till the previous interpolation instruction execution is completed and then execute current instruction immediately. When the distance between the terminal actuator position and the final position of the previous interpolation instruction equals the value of <i>TransitionParameter</i> during the execution of the previous interpolation instruction, the previous interpolation instruction execution is completed immediately and then current instruction execution starts. During the execution of the current instruction, the terminal actuator moves for a circular arc and then makes a linear interpolation. The distance between the end point of the circular arc and the end point of the previous interpolation instruction is still equal to the value of <i>TransitionParameter</i> as illustrated in the following example 3.

**Programming Example 1**

The example in which one DMC_MoveLinearRelative instruction is executed is as follows.

1. The variable table and program

Variable name	Data type	Initial value
ADDAXIS1	DMC_AddAxisToGroup	
ADDAXIS1_Ex	BOOL	
ADDAXIS1_Done	BOOL	
ADDAXIS1_Bsy	BOOL	
ADDAXIS1_Err	BOOL	
ADDAXIS1_ErrID	WORD	
ADDAXIS2	DMC_AddAxisToGroup	

Variable name	Data type	Initial value
ADDAXIS2_Done	BOOL	
ADDAXIS2_Bsy	BOOL	
ADDAXIS2_Err	BOOL	
ADDAXIS2_ErrID	WORD	
ADDAXIS3	DMC_AddAxisToGroup	
ADDAXIS3_Done	BOOL	
ADDAXIS3_Bsy	BOOL	
ADDAXIS3_Err	BOOL	
ADDAXIS3_ErrID	WORD	
DMC_GroupEnable	DMC_GroupEnable	
GE_En	BOOL	
GE_Vel	ARRAY [1..8] OF LREAL	
GE_Acc	ARRAY [1..8] OF LREAL	
GE_Dec	ARRAY [1..8] OF LREAL	
GE_Jerk	ARRAY [1..8] OF LREAL	
GE_Status	BOOL	
GE_Bsy	BOOL	
GE_Abt	BOOL	
GE_Err	BOOL	
GE_ErrID	WORD	
LINREL	DMC_MoveLinearRelative	
LINREL_Ex	BOOL	
LINREL_Dis	ARRAY [1..8] OF LREAL	
LINREL_Done	BOOL	
LINREL_Bsy	BOOL	
LINREL_Act	BOOL	
LINREL_Abt	BOOL	
LINREL_Err	BOOL	
LINREL_ErrID	WORD	

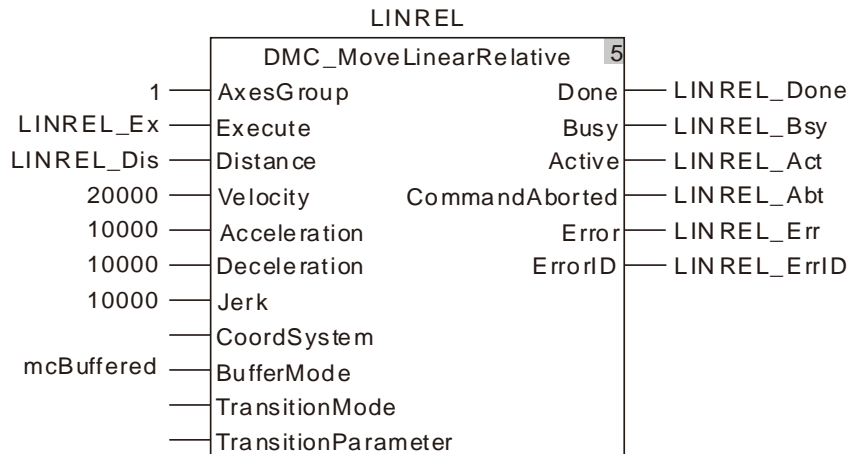
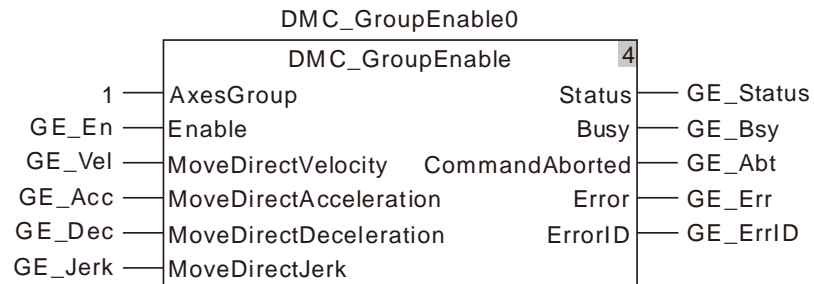
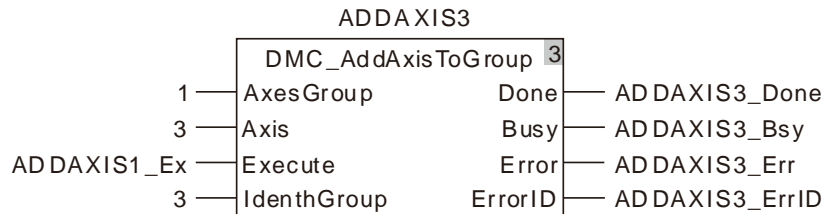
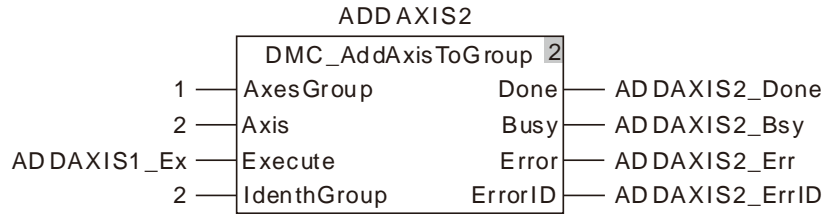
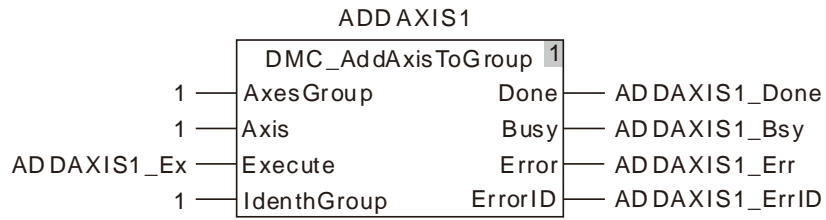

2. See the entire motion process after the instruction is executed.

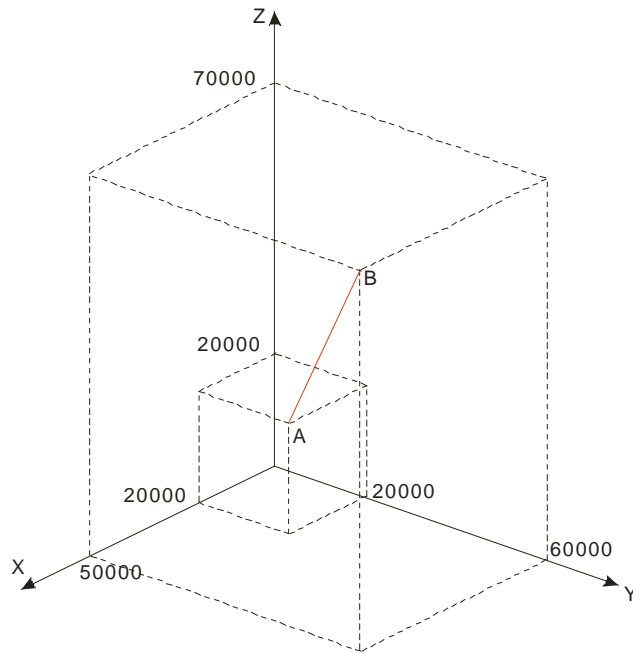

3. X axis-Y axis-Z axis Motion Curve and Timing Chart

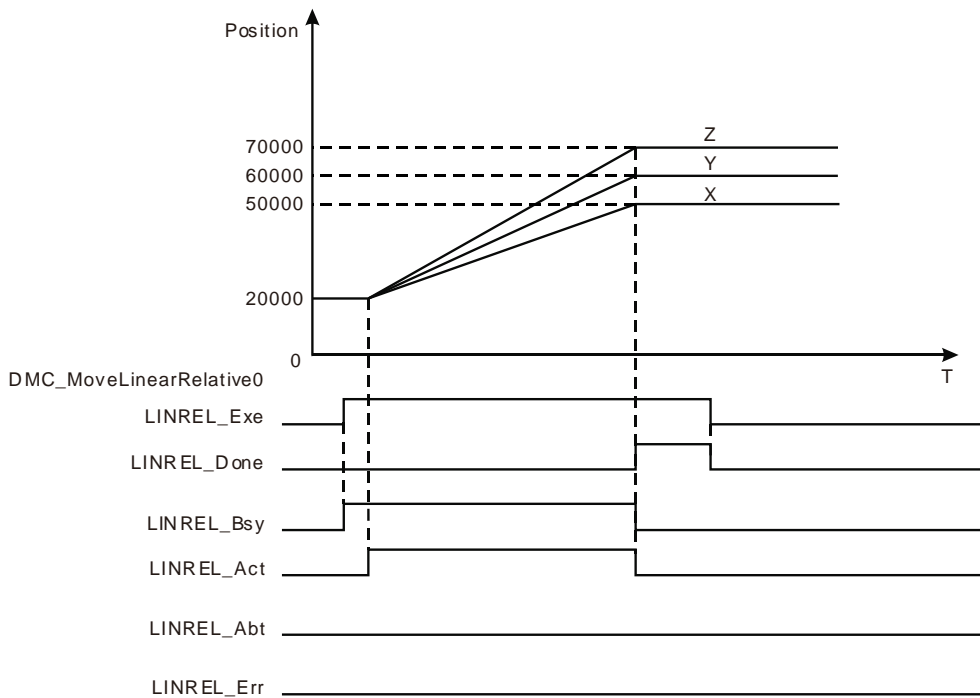

- ❖ The start positions of X axis, Y axis and Z axis are all 20,000. LINREL_Dis[1], LINREL_Dis[2] and LINREL_Dis[3] of DMC_MoveLinearRelative are set to 30,000, 40,000 and 50,000 respectively.
- ❖ When LINREL_Exe changes to TRUE, LINREL_Bsy changes to TRUE. Two cycles later, LINREL_Act changes to TRUE and the axes group starts to run.
- ❖ X axis, Y axis and Z axis reach respective target positions simultaneously, LINREL_Done changes to TRUE and LINREL_Bsy and LINREL_Act change to FALSE when the execution of DMC_MoveLinearRelative instruction is completed.



Programming Example 2

See the following example in which there are two DMC_MoveLinearRelative instructions and the transition mode between them is mcTMConstantVelocity.

1. The variable table and program

Variable name	Data type	Initial value
ADDAXIS1	DMC_AddAxisToGroup	
ADDAXIS1_Ex	BOOL	
ADDAXIS1_Done	BOOL	
ADDAXIS1_Bsy	BOOL	
ADDAXIS1_Err	BOOL	
ADDAXIS1_ErrID	WORD	
ADDAXIS2	DMC_AddAxisToGroup	
ADDAXIS2_Done	BOOL	
ADDAXIS2_Bsy	BOOL	
ADDAXIS2_Err	BOOL	
ADDAXIS2_ErrID	WORD	
DMC_GroupEnable0	DMC_GroupEnable	
GE_En	BOOL	
GE_Vel	ARRAY [1..8] OF LREAL	
GE_Acc	ARRAY [1..8] OF LREAL	
GE_Dec	ARRAY [1..8] OF LREAL	
GE_Jerk	ARRAY [1..8] OF LREAL	
GE_Status	BOOL	
GE_Bsy	BOOL	
GE_Abt	BOOL	
GE_Err	BOOL	
GE_ErrID	WORD	
LINREL1	DMC_MoveLinearRelative	
LINREL1_Ex	BOOL	
LINREL1_Dis	ARRAY [1..8] OF LREAL	
LINREL1_Done	BOOL	
LINREL1_Bsy	BOOL	
LINREL1_Act	BOOL	
LINREL1_Abt	BOOL	
LINREL1_Err	BOOL	
LINREL1_ErrID	WORD	
LINREL2	DMC_MoveLinearRelative	
LINREL2_Dis	ARRAY [1..8] OF LREAL	
LINREL2_Done	BOOL	

Variable name	Data type	Initial value
LINREL2_Bsy	BOOL	
LINREL2_Act	BOOL	
LINREL2_Abt	BOOL	
LINREL2_Err	BOOL	
LINREL2_ErrID	WORD	

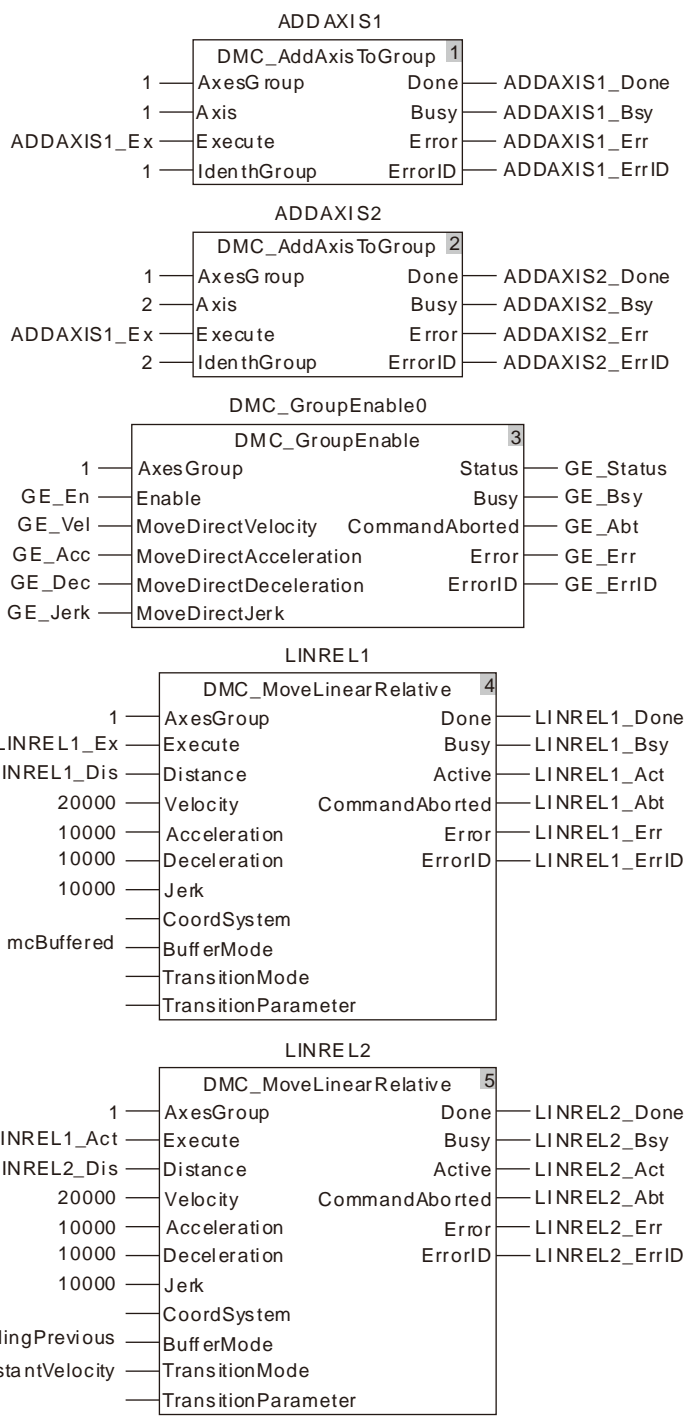

2. Motion Curve and Timing Chart of the terminal actuator

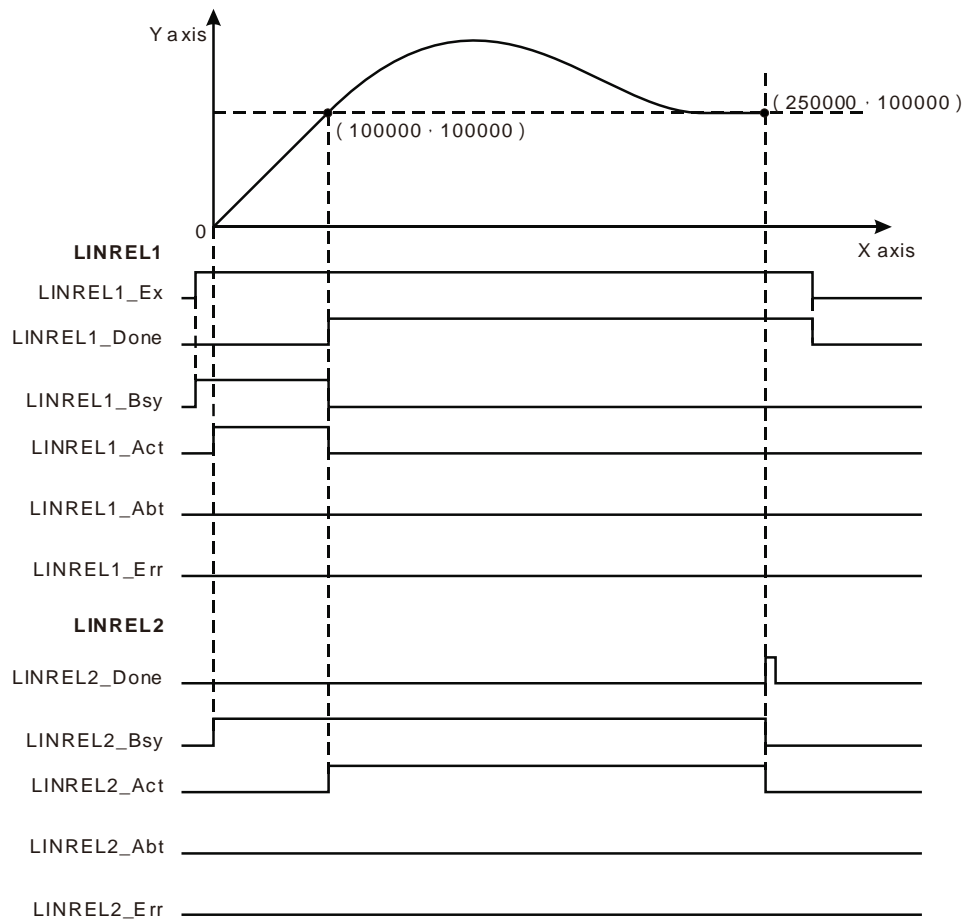

- ❖ Set BufferMode to mcBlendingPrevious and TransitionMode to mcTMConstantVelocity and for LINREL2.
- ❖ LINREL1_Dis [1] and LINREL1_Dis [2] of LINREL1 are both set to 100,000. LINREL2_Dis [1] and LINREL2_Dis [2] of LINREL2 are set 150,000 and 0.
- ❖ ADDAXIS1 and ADDAXIS2 are executed first and then DMC_GroupEnable0 is executed. When the axes group is enabled, LINREL1 is executed and then LINREL2 is executed immediately.
- ❖ When the terminal actuator gets to (100,000, 100,000) in the coordinate system, LINREL1_Done changes to TRUE. Meanwhile LINREL2_Act changes to TRUE and LINREL2 starts to execute. At the moment the velocity of the terminal actuator is the target velocity of the previous instruction, 20,000.
- ❖ After LINREL2 is executed, the terminal actuator conducts the smooth transition and then makes the linear motion. The instruction execution is completed when the terminal actuator reaches the coordinates (250,000,100,000).



Programming Example 3

The example in which there are two DMC_MoveLinearRelative instructions and the transition mode between them is mcTMCornerDistance is as follows.

1. The variable table and program

Variable name	Data type	Initial value
ADDAXIS1	DMC_AddAxisToGroup	
ADDAXIS1_Ex	BOOL	
ADDAXIS1_Done	BOOL	

Variable name	Data type	Initial value
ADDAXIS1_Bsy	BOOL	
ADDAXIS1_Err	BOOL	
ADDAXIS1_ErrID	WORD	
ADDAXIS2	DMC_AddAxisToGroup	
ADDAXIS2_Done	BOOL	
ADDAXIS2_Bsy	BOOL	
ADDAXIS2_Err	BOOL	
ADDAXIS2_ErrID	WORD	
DMC_GroupEnable0	DMC_GroupEnable	
GE_En	BOOL	
GE_Vel	ARRAY [1..8] OF LREAL	
GE_Acc	ARRAY [1..8] OF LREAL	
GE_Dec	ARRAY [1..8] OF LREAL	
GE_Jerk	ARRAY [1..8] OF LREAL	
GE_Status	BOOL	
GE_Bsy	BOOL	
GE_Abt	BOOL	
GE_Err	BOOL	
GE_ErrID	WORD	
LINREL1	DMC_MoveLinearRelative	
LINREL1_Ex	BOOL	
LINREL1_Dis	ARRAY [1..8] OF LREAL	
LINREL1_Done	BOOL	
LINREL1_Bsy	BOOL	
LINREL1_Act	BOOL	
LINREL1_Abt	BOOL	
LINREL1_Err	BOOL	
LINREL1_ErrID	WORD	
LINREL2	DMC_MoveLinearRelative	
LINREL2_Dis	ARRAY [1..8] OF LREAL	
LINREL2_Done	BOOL	
LINREL2_Bsy	BOOL	
LINREL2_Act	BOOL	
LINREL2_Abt	BOOL	
LINREL2_Err	BOOL	
LINREL2_ErrID	WORD	

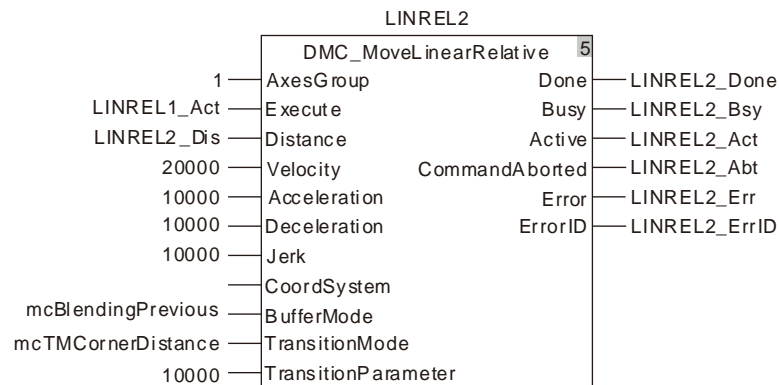
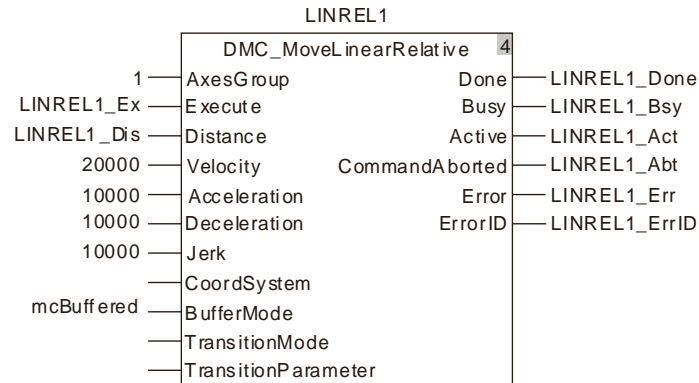
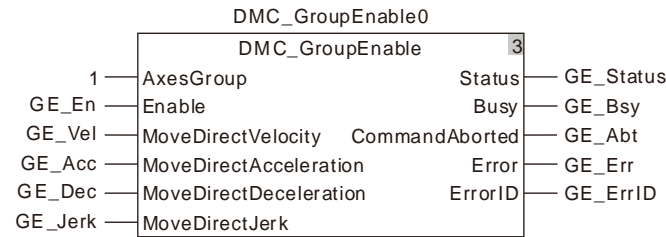
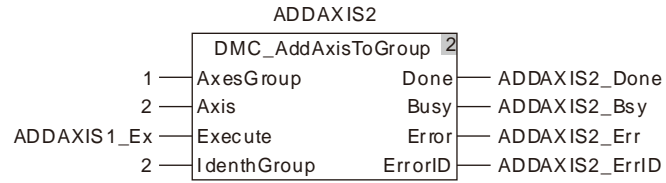
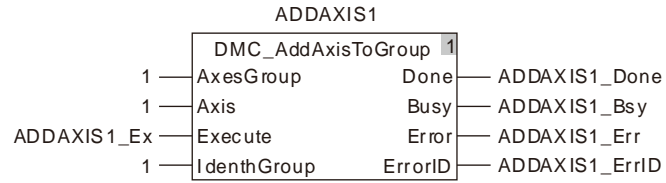

2. Motion Curve and Timing Chart of the terminal actuator

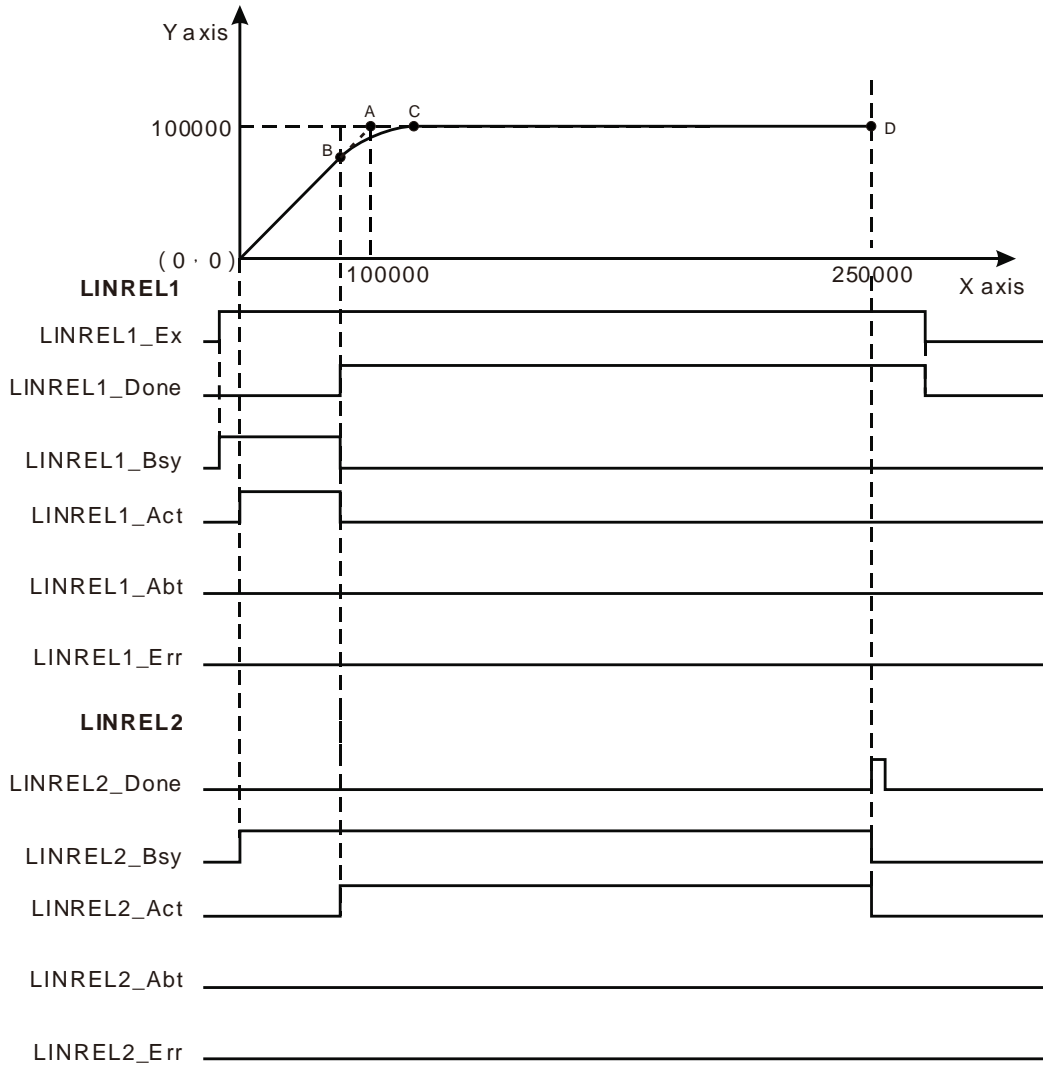

- ❖ Set BufferMode to mcBlendingPrevious, TransitionMode to mcTMCornerDistance and TransitionParameter to 10000 for LINREL2.
- ❖ LINREL1_Dis [1] and LINREL1_Dis [2] of LINREL1 are both set to 100,000. LINREL2_Dis [1] and LINREL2_Dis [2] of LINREL2 are set 150,000 and 0.
- ❖ ADDAXIS1 and ADDAXIS2 are executed first and then DMC_GroupEnable0 is executed. When the axes group is enabled, LINREL1 is executed and then LINREL2 is executed immediately.
- ❖ When the terminal actuator gets to point B in the coordinate system, LINREL1_Done changes to TRUE. Meanwhile LINREL2_Act changes to TRUE and LINREL2 starts to execute.
- ❖ After LINREL2 is executed, the terminal actuator moves along an arc and then continues to make the linear interpolation after passing by point C.
- ❖ The distance from point B to point A equals that from point C to point A. It is also equal to 10,000, the value of TransitionParameter of LINREL2.

11.7.12 DMC_MoveCircularAbsolute

FB/FC	Explanation	Applicable model
FB	DMC_MoveCircularAbsolute controls axes to perform the circular interpolation. The end positions of axes are absolute positions.	DVP15MC11T DVP15MC11T-06

DMC_MoveCircularAbsolute_instance

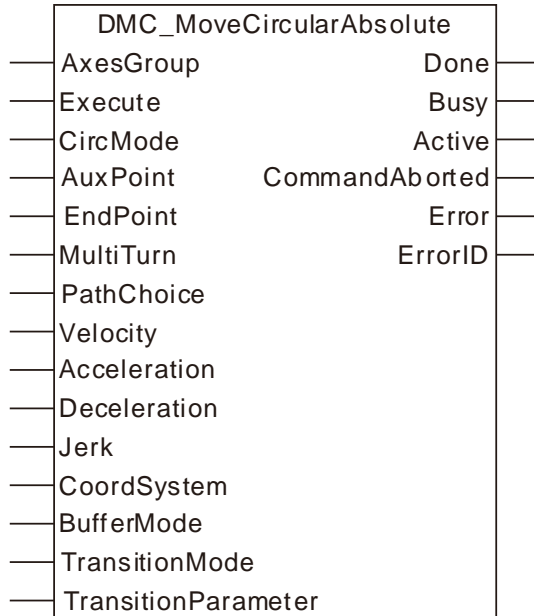

- **Input Parameters**

Parameter name	Function	Data type	Valid range (Default)	Validation timing
AxesGroup	The axes group number	USINT	1~8 (The variable value must be set)	When <i>Execute</i> changes from FALSE to TRUE.
Execute	The instruction is executed when <i>Execute</i> changes from FALSE to TRUE.	BOOL	TRUE or FALSE (FALSE)	
CircMode	Set the mode of circular interpolation 0: Draw an arc via a center on XY plane. 1: Draw an arc via a center on ZX plane. 2: Draw an arc via a center on YZ plane. 3: Draw an arc via the radius on XY plane. 4: Draw an arc via the radius on ZX plane. 5: Draw an arc via the radius on YZ plane.	INT	0~5 (0)	When <i>Execute</i> changes from FALSE to TRUE.
Aux Point	It is the coordinates for the center when an arc	ARRAY [1..2] OF	Positive number, 0, negative number	When <i>Execute</i> changes from

Parameter name	Function	Data type	Valid range (Default)	Validation timing
	is drawn via a center. Auxpoint[1] means the radius and AuxPoint[2] is meaningless when an arc is drawn via a radius.	LREAL	(0)	FALSE to TRUE.
EndPoint	Positions on coordinate axes for the end point of an arc	ARRAY [1..8] OF LREAL	Positive number, 0, negative number (0)	When <i>Execute</i> changes from FALSE to TRUE.
MultiTurn	Set the number of turns for helical interpolation	UINT	Positive number, 0 (0)	When <i>Execute</i> changes from FALSE to TRUE.
PathChoice	The direction for circular interpolation 0: Clockwise 1: Counterclockwise	INT	0、1 (0)	When <i>Execute</i> changes from FALSE to TRUE.
Velocity	Set the maximum velocity (Unit: unit/second)	LREAL	Positive number (0)	When <i>Execute</i> changes from FALSE to TRUE.
Acceleration	Set the maximum acceleration (Unit: Unit/second ²)	LREAL	Positive number (0)	When <i>Execute</i> changes from FALSE to TRUE.
Deceleration	Set the maximum deceleration (Unit: Unit/second ²)	LREAL	Positive number (0)	When <i>Execute</i> changes from FALSE to TRUE.
Jerk	Set the maximum jerk (Unit: Unit/second ³)	LREAL	Positive number (0)	When <i>Execute</i> changes from FALSE to TRUE.
CoordSystem	Reserved			
BufferMode	Specify the buffer mode between two axes group instructions. 1: Buffered 3: Blending with the speed of previous instruction	MC_Buffer_Mode	1: mcBuffered 3: mcBlendingPrevious	When <i>Execute</i> changes from FALSE to TRUE.
TransitionMode	Specify the transition mode between two axes group instructions 0: No transition curve inserted 3: Make the transition based on the specified corner distance	MC_Transition_Mode	0: mcTMNone 3: mcTMCornerDistance	When <i>Execute</i> changes from FALSE to TRUE.
TransitionParameter	Set the transition parameter for specific	LREAL	Positive number, 0 (0)	When <i>Execute</i> changes from FALSE to TRUE.

Parameter name	Function	Data type	Valid range (Default)	Validation timing
	transition mode			

Note:

- DMC_MoveCircularAbsolute instruction starts being executed when *Execute* changes from FALSE to TRUE. Changing *Execute* from TRUE to FALSE during the instruction execution will have no impact on the instruction execution.
- When drawing an arc by adopting the center method, the values of AuxPoint[1] and AuxPoint[2] are the coordinate differences between the center and start point of a circular arc. When drawing an arc by adopting the radius method, the value of the input AuxPoint[1] is the radius. The value of AuxPoint[2] is meaningless.
- The value of input parameter EndPoint[1]~EndPoint[8] means the coordinates for the end point of an arc on axes.
- Refer to section 10.2 for the relationship among Velocity, Acceleration, Deceleration and Jerk .
- For details on BufferMode, refer to section 10.3.

- Output Parameters**

Parameter name	Function	Data type	Valid range
Done	TRUE when the instruction execution is completed.	BOOL	TRUE / FALSE
Busy	TRUE when the instruction is being executed.	BOOL	TRUE / FALSE
Active	TRUE when the instruction is controlling axes.	BOOL	TRUE / FALSE
CommandAborted	TRUE when the instruction execution is aborted.	BOOL	TRUE / FALSE
Error	TRUE when an error occurs in execution of the instruction.	BOOL	TRUE / FALSE
ErrorID	Contains the error code when an error occurs. Please refer to section 12.2.	WORD	

- Output Update Timing**

Name	Timing for changing to TRUE	Timing for changing to FALSE
Done	◆ When the end positions are reached.	◆ When <i>Execute</i> changes from TRUE to FALSE after the instruction execution is completed ◆ <i>Done</i> changes to TRUE when the instruction execution is completed after <i>Execute</i> changes from TRUE to FALSE during the instruction execution. One cycle later, <i>Done</i> changes to FALSE.
Busy	◆ When <i>Execute</i> changes to TRUE.	◆ When <i>Done</i> changes to TRUE ◆ When <i>Error</i> changes to TRUE ◆ When <i>CommandAbort</i> changes to TRUE
Active	◆ When axes start being controlled by the instruction.	◆ When <i>Done</i> changes to TRUE ◆ When <i>Error</i> changes to TRUE ◆ When <i>CommandAbort</i> changes to TRUE
CommandAbort	◆ When the instruction execution is aborted by other motion instruction.	◆ When <i>Execute</i> changes from TRUE to FALSE
Error	◆ When an error occurs	◆ When <i>Execute</i> changes from TRUE to FALSE

Name	Timing for changing to TRUE	Timing for changing to FALSE
	in the instruction execution or the input parameters for the instruction are illegal.	

● **Output Update Timing Chart**

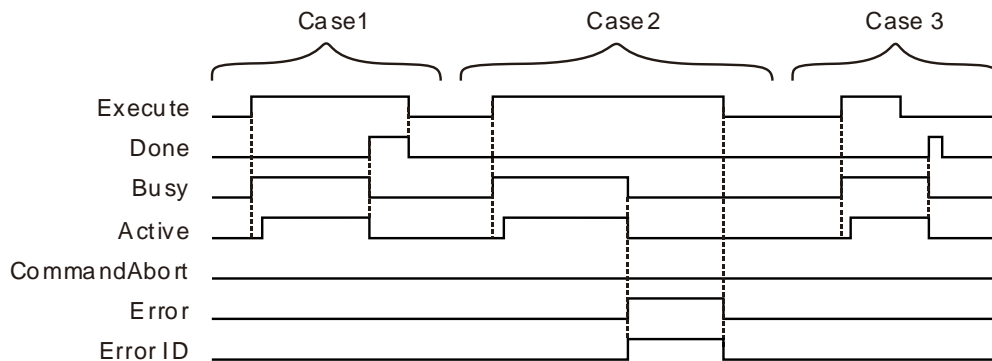

Case 1 : When *Execute* changes from FALSE to TRUE, *Busy* changes to TRUE. Three cycles later, *Active* changes to TRUE. When the axes group reaches the end position, *Done* changes to TRUE, *Busy* and *Active* change to FALSE.

Case 2 : When *Execute* changes from FALSE to TRUE and an error occurs (such as error in state machine of the axes group), *Error* changes to TRUE and *ErrorID* shows corresponding error codes and meanwhile *Busy* and *Active* change to FALSE. When *Execute* changes from TRUE to FALSE, *Error* changes to FALSE.

Case 3 : After *Execute* changes from TRUE to FALSE in the instruction execution, *Done* changes to TRUE when the instruction execution is completed. Meantime *Busy* and *Active* change to FALSE. One cycle later, *Done* changes to FALSE.

● **Function**

DMC_MoveCircularAbsolute is used for axes to perform the circular interpolation. The firmware of V1.01 and above supports the function.

■ **CirMode (Circular interpolation mode)**

There are six CirMode modes as follows.

CirMode value	Description
0	Draw an arc via the center on XY plane. AuxPoint[1] is the offset value of the center on basis of the start point on X-axis. AuxPoint[2] is the offset value of the center on basis of the start point on Y-axis.

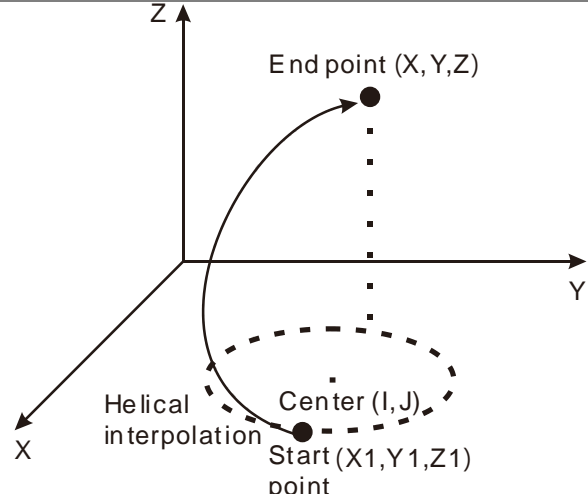
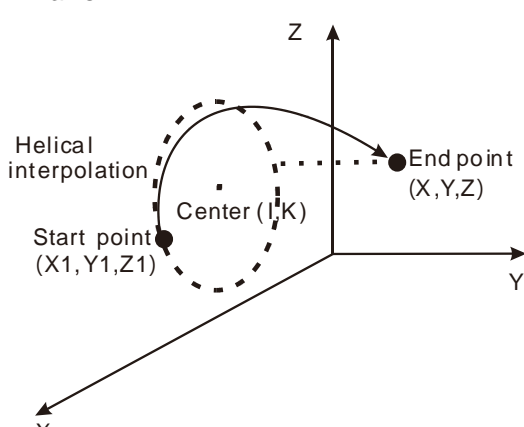
CirMode value	Description
	 <p>In the figure above, coordinates for the center: $I=X1+AuxPoint[1], J=Y1+AuxPoint[2]$, Coordinates for the end point: $X=EndPoint[1], Y=EndPoint[2], Z=EndPoint[3]$</p>
1	<p>Draw an arc via the center on ZX plane. AuxPoint[1] is the offset value of the center on basis of the start point on X-axis. AuxPoint[2] is the offset value of the center on basis of the start point on Z-axis.</p>  <p>In the figure above, coordinates for the center: $I=X1+AuxPoint[1], K=Z1+AuxPoint[2]$, Coordinates for the end point: $X=EndPoint[1], Y=EndPoint[2], Z=EndPoint[3]$</p>
2	<p>Draw an arc via the center on YZ plane. AuxPoint[1] is the offset value of the center on basis of the start point on Y-axis. AuxPoint[2] is the offset value of the center on basis of the start point on Z-axis.</p>

11

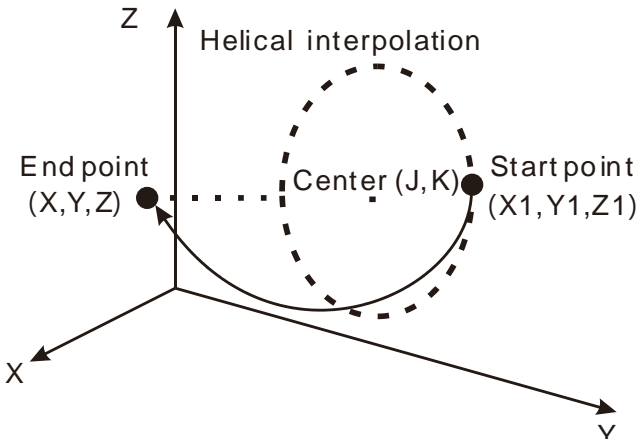
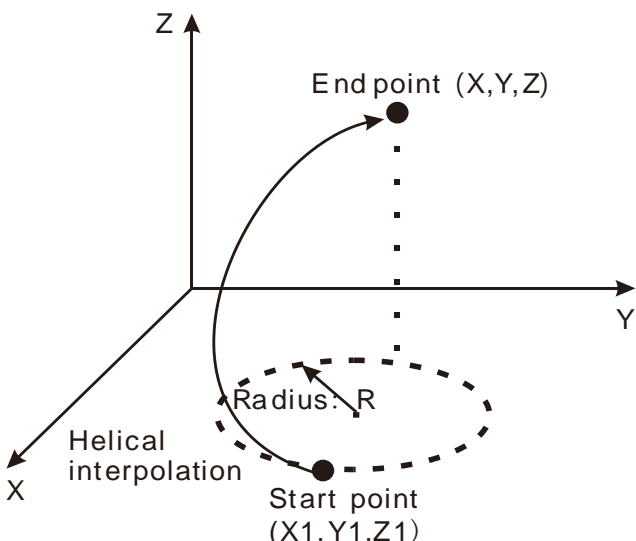
CirMode value	Description
	 <p>In the figure above, coordinates for the center: $J=Y1+AuxPoint[1]$, $K=Z1+AuxPoint[2]$ Coordinates for the end point: $X=EndPoint[1]$, $Y=EndPoint[2]$, $Z=EndPoint[3]$</p>
3	<p>Draw an arc via the radius on XY plane. The value of $AuxPoint[1]$ is the radius of the circle on XY plane and the value of $AuxPoint[2]$ is meaningless. If the value of $AuxPoint[1]$ is greater than 0, it is a <u>minor arc</u>. If the value of $AuxPoint[1]$ is less than 0, it is a <u>major arc</u>.</p>  <p>In the figure above, Radius: $R=AuxPoint[1]$, Coordinates for end point: $X=EndPoint[1]$, $Y=EndPoint[2]$, $Z=EndPoint[3]$</p>
4	<p>Draw an arc via the radius on ZX plane. The value of $AuxPoint[1]$ is the radius of the circle on ZX plane and the value of $AuxPoint[2]$ is meaningless.</p>

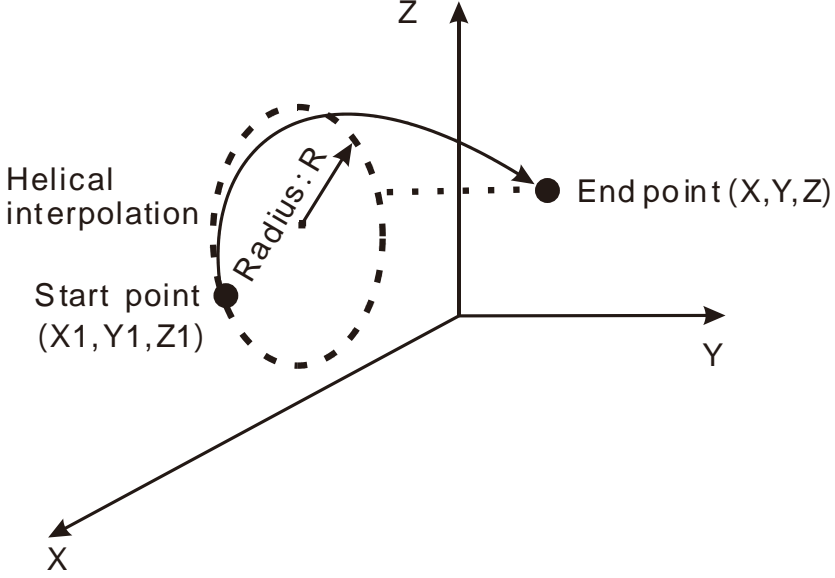
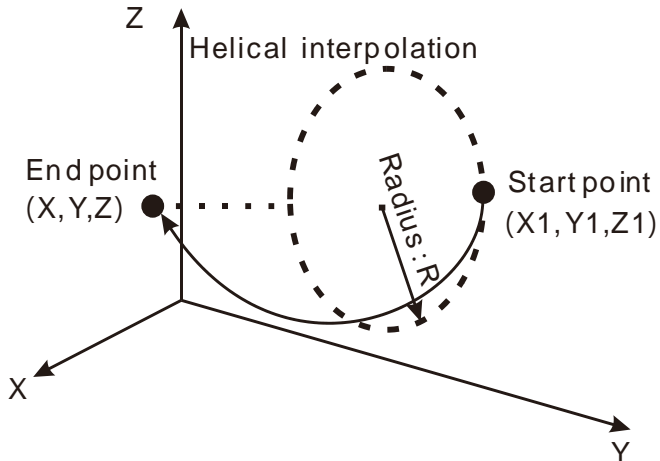
CirMode value	Description
	 <p>In the figure above, Radius: $R = \text{AuxPoint}[1]$, Coordinates for end point: $X = \text{EndPoint}[1]$, $Y = \text{EndPoint}[2]$, $Z = \text{EndPoint}[3]$</p>
5	<p>Draw circles via the radius on ZY plane. The value of $\text{AuxPoint}[1]$ is the radius of the circle on ZY plane and the value of $\text{AuxPoint}[2]$ is meaningless.</p>  <p>In the figure above, Radius: $R = \text{AuxPoint}[1]$ Coordinates for end point: $X = \text{EndPoint}[1]$, $Y = \text{EndPoint}[2]$, $Z = \text{EndPoint}[3]$.</p>

■ PathChoice

The parameter determines the direction for circular interpolation. See the details as follows.

PathChoice Value	Description
0	The axes group conducts circular interpolation in the clockwise direction on the arcs of the specified plane. Take the radius method for example, the path for the circular motion is shown as below.

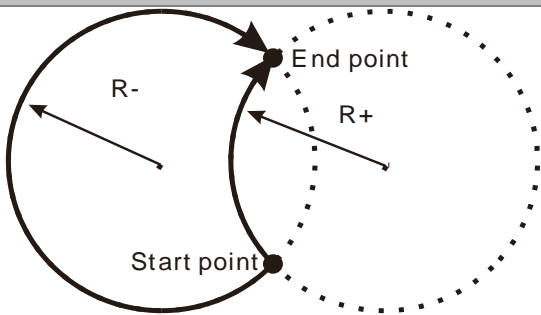
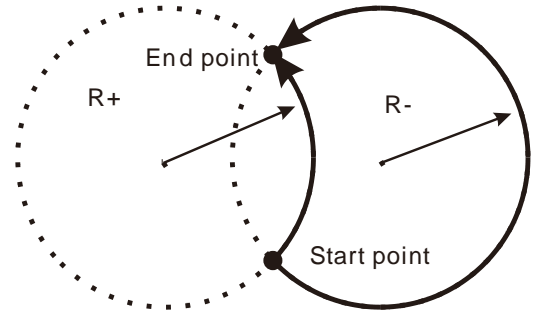
PathChoice Value	Description
	 <p>Clockwise motion</p>
1	<p>The axes group conducts circular interpolation in the anticlockwise direction on the arcs of the specified plane. Take the radius method for example, the path for the circular motion is shown as below.</p>  <p>Counterclockwise motion</p>

■ BufferMode

Specify the buffer mode between current instruction and previous interpolation instruction. See the details as follows.

BufferMode value	Description
mcBuffered (1)	Current instruction will wait and not be executed till the previous interpolation instruction execution is finished.
mcBlendingPrevious (3)	The transition between current instruction and previous interpolation instruction is conducted in the mode specified by <i>TransitionMode</i> . The <i>BufferMode</i> of DMC_MoveCircularRelative can select this mode only when current instruction is a linear interpolation instruction.

 Programming Example

The example of executing one DMC_MoveCircularAbsolute instruction is shown as follows.

1. The variable table and program

Variable name	Data type	Initial value
ADDAXIS1	DMC_AddAxisToGroup	
ADDAXIS1_Ex	BOOL	
ADDAXIS1_Done	BOOL	
ADDAXIS1_Bsy	BOOL	
ADDAXIS1_Err	BOOL	
ADDAXIS1_ErrID	WORD	
ADDAXIS2	DMC_AddAxisToGroup	

Variable name	Data type	Initial value
ADDAXIS2_Done	BOOL	
ADDAXIS2_Bsy	BOOL	
ADDAXIS2_Err	BOOL	
ADDAXIS2_ErrID	WORD	
DMC_GroupEnable0	DMC_GroupEnable	
GE_En	BOOL	
GE_Vel	ARRAY [1..8] OF LREAL	
GE_Acc	ARRAY [1..8] OF LREAL	
GE_Dec	ARRAY [1..8] OF LREAL	
GE_Jerk	ARRAY [1..8] OF LREAL	
GE_Status	BOOL	
GE_Bsy	BOOL	
GE_Abt	BOOL	
GE_Err	BOOL	
GE_ErrID	WORD	
CIRABS	DMC_MoveCircularAbsolute	
CIRABS_Ex	BOOL	
CIRABS_Mode	INT	0
CIRABS_Auxp	ARRAY [1..2] OF LREAL	
CIRABS_Endp	ARRAY [1..8] OF LREAL	
CIRABS_T	UINT	0
CIRABS_PC	INT	0
CIRABS_Done	BOOL	
CIRABS_Bsy	BOOL	
CIRABS_Act	BOOL	
CIRABS_Abt	BOOL	
CIRABS_Err	BOOL	
CIRABS_ErrID	WORD	

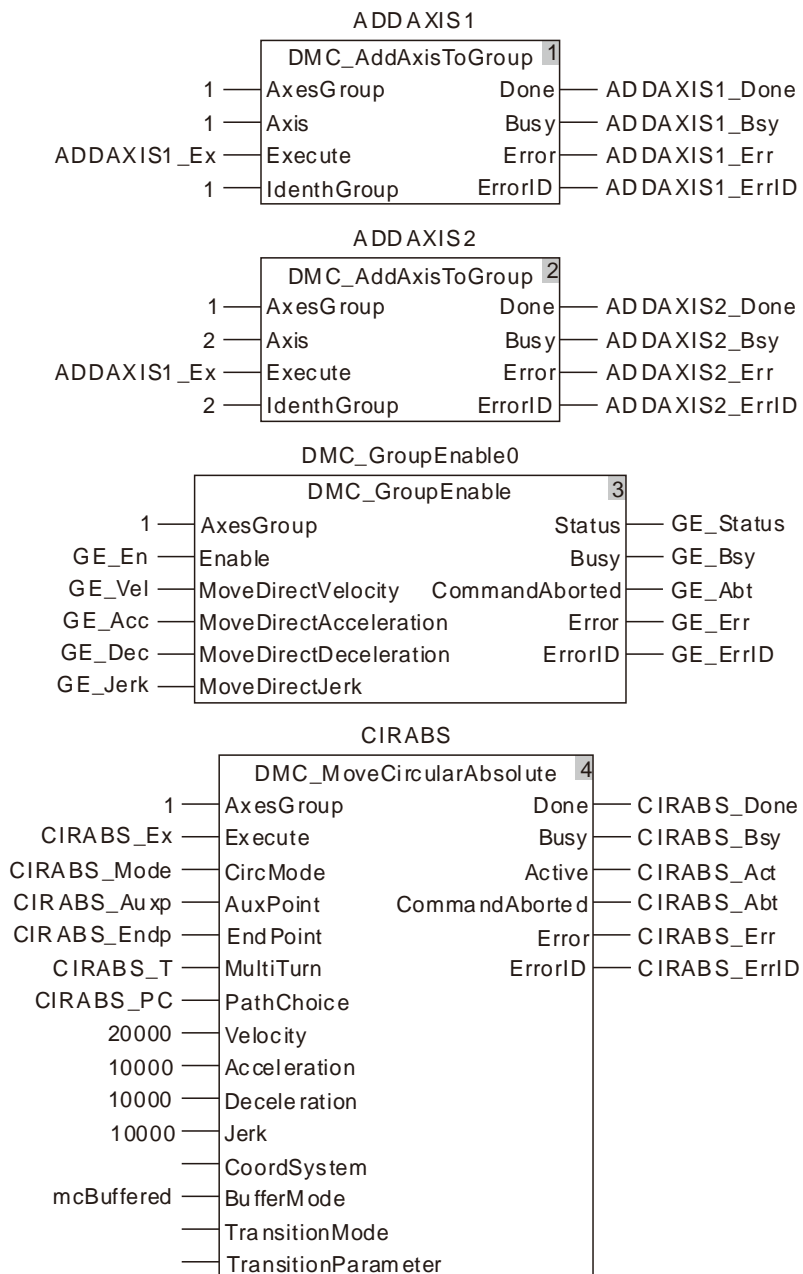

2. Motion Curve in the X-Y Coordinate System and Timing Chart

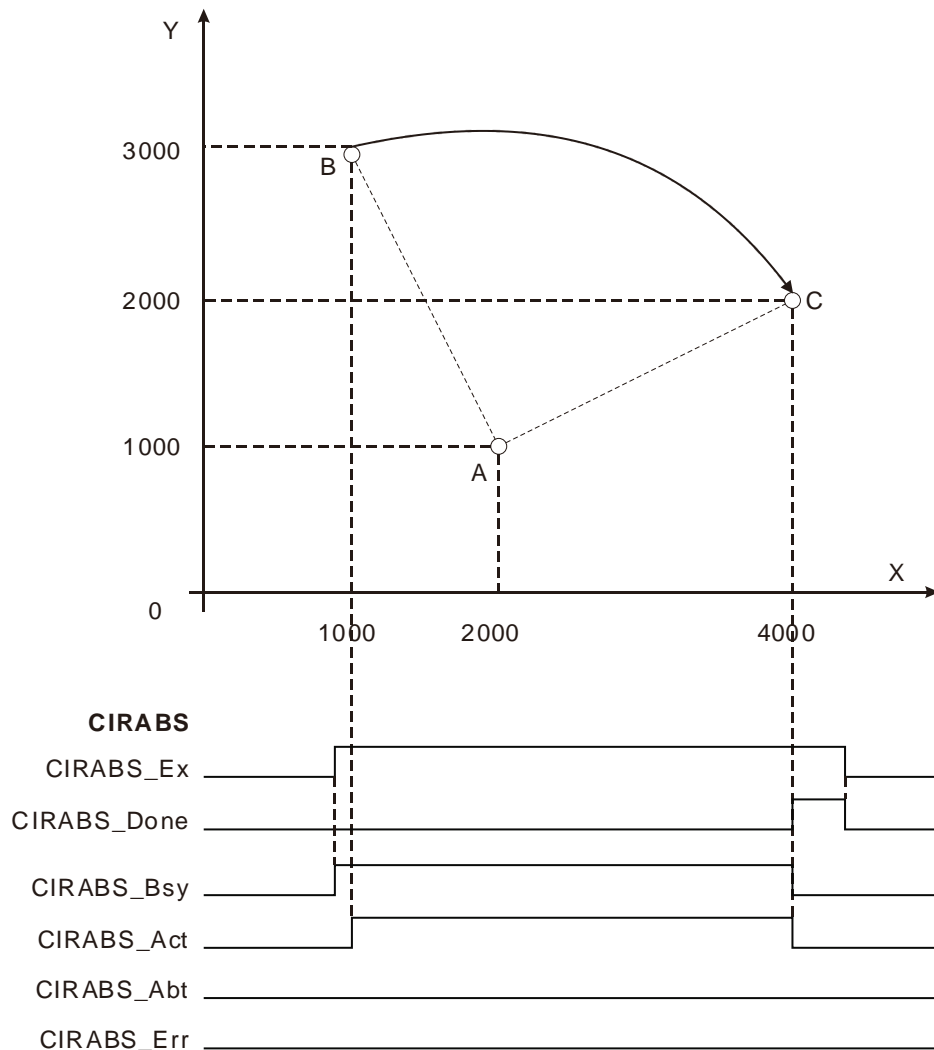

- ❖ The value of CIRABS_Auxp[1] is set to 1000, the value of CIRABS_Auxp[2] is set to -2000, the value of CIRABS_Endp[1] is set to 4000, the value of CIRABS_Endp[2] is set to 2000 and the value of CIRABS_Mode is set to 0.
- ❖ Point B is the start point of the arc with coordinates (1000, 3000). Point A is the center of the circle where the arc is with the coordinates (1000+CIRABS_Auxp[1]=2000, 3000+CIRABS_Auxp[2]=1000). Point C is the end point of the arc with coordinates (CIRABS_Endp[1]=4000, CIRABS_Endp[2]=2000).
- ❖ After DMC_MoveCircularAbsolute instruction is executed, the clockwise circular interpolation is conducted by starting from point B and regarding point A as the center. The instruction execution is finished when point C is reached.

11.7.13 DMC_MoveCircularRelative

FB/FC	Explanation	Applicable model
FB	DMC_MoveCircularRelative controls axes to perform the circular interpolation. The end positions of axes are relative positions.	DVP15MC11T DVP15MC11T-06

11

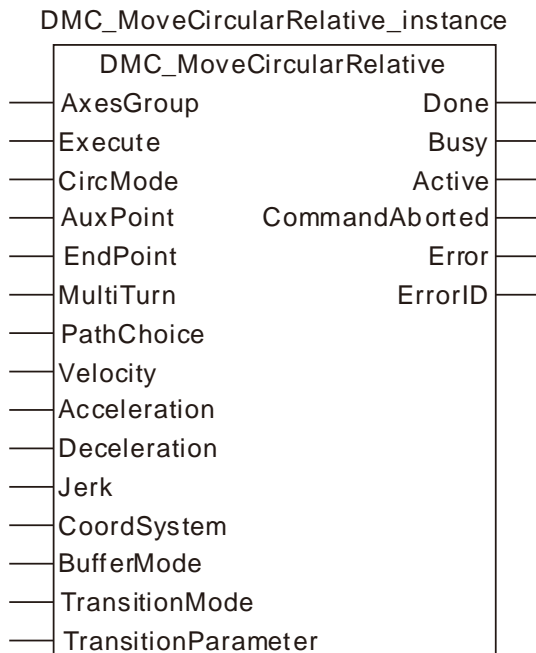

● **Input Parameters**

Parameter name	Function	Data type	Valid range (Default)	Validation timing
AxesGroup	The axes group number	USINT	1~8 (The variable value must be set)	When <i>Execute</i> changes from FALSE to TRUE.
Execute	The instruction is executed when <i>Execute</i> changes from FALSE to TRUE.	BOOL	TRUE or FALSE (FALSE)	
CircMode	Set the mode of circular interpolation. 0: Draw an arc via a center on XY plane. 1: Draw an arc via a center on ZX plane. 2: Draw an arc via a center on YZ plane. 3: Draw an arc via the radius on XY plane. 4: Draw an arc via the radius on ZX plane. 5: Draw an arc via the radius on YZ plane.	INT	0~5 (0)	When <i>Execute</i> changes from FALSE to TRUE.
AuxPoint	It is the coordinates for the center when an arc	ARRAY [1..2] OF LREAL	Positive number, 0, negative number	When <i>Execute</i> changes from

Parameter name	Function	Data type	Valid range (Default)	Validation timing
	is drawn via a center. Auxpoint[1] means the radius and AuxPoint[2] is meaningless when an arc is drawn via a radius.		(0)	FALSE to TRUE.
EndPoint	Coordinate differences on axes between the end point and start point of an arc	ARRAY [1..8] OF LREAL	Positive number, 0, negative number (0)	When Execute changes from FALSE to TRUE.
MultiTurn	Set the number of turns for helical interpolation	UINT	Positive number, 0 (0)	When <i>Execute</i> changes from FALSE to TRUE.
PathChoice	The direction for circular interpolation 0: Clockwise 1: Counterclockwise	INT	0, 1 (0)	When <i>Execute</i> changes from FALSE to TRUE.
Velocity	Set the maximum velocity (Unit: unit/second)	LREAL	Positive number (0)	When <i>Execute</i> changes from FALSE to TRUE.
Acceleration	Set the maximum acceleration (Unit: Unit/second ²)	LREAL	Positive number (0)	When <i>Execute</i> changes from FALSE to TRUE.
Deceleration	Set the maximum deceleration (Unit: Unit/second ²)	LREAL	Positive number (0)	When <i>Execute</i> changes from FALSE to TRUE.
Jerk	Set the maximum jerk (Unit: Unit/second ³)	LREAL	Positive number (0)	When <i>Execute</i> changes from FALSE to TRUE.
CoordSystem	Reserved			
BufferMode	Specify the buffer mode between two axes group instructions. 1: Buffered 3: Blending with the speed of previous instruction	MC_Buffer_Mode	1: mcBuffered 3: mcBlendingPrevious	When <i>Execute</i> changes from FALSE to TRUE.
TransitionMode	Specify the transition mode between two axes group instructions 0: No transition curve inserted 3: Make the transition based on the specified corner distance	MC_Transition_Mode	0: mcTMNone 3: mcTMCornerDistance	When <i>Execute</i> changes from FALSE to TRUE.

Parameter name	Function	Data type	Valid range (Default)	Validation timing
TransitionParameter	Set the transition parameter for specific transition mode	LREAL	Positive number, 0 (0)	When <i>Execute</i> changes from FALSE to TRUE.

Note:

1. DMC_MoveCircularRelative instruction starts being executed when *Execute* changes from FALSE to TRUE. Changing *Execute* from TRUE to FALSE during the instruction execution will have no impact on the instruction execution.
2. When drawing an arc by adopting the center method, the values of AuxPoint[1] and AuxPoint[2] are the coordinate differences between the center and start point of a circular arc. When drawing an arc by adopting the radius method, the value of the input AuxPoint[1] is the radius. The value of AuxPoint[2] is meaningless.
3. The value of input parameter EndPoint[1]~EndPoint[8] means the coordinate differences between end point and start point on axes.
4. Refer to section 10.2 for the relationship among Velocity, Acceleration, Deceleration and Jerk .
5. For details on BufferMode, refer to section 10.3.

● **Output Parameters**

Parameter name	Function	Data type	Valid range
Done	TRUE when the instruction execution is completed.	BOOL	TRUE / FALSE
Busy	TRUE when the instruction is being executed.	BOOL	TRUE / FALSE
Active	TRUE when the instruction is controlling the axes group.	BOOL	TRUE / FALSE
CommandAborted	TRUE when the instruction execution is aborted.	BOOL	TRUE / FALSE
Error	TRUE when an error occurs in execution of the instruction.	BOOL	TRUE / FALSE
ErrorID	Contains the error code when an error occurs. Please refer to section 12.2.	WORD	

● **Output Update Timing**

Name	Timing for changing to TRUE	Timing for changing to FALSE
Done	◆ When the end positions are reached.	◆ When <i>Execute</i> changes from TRUE to FALSE after the instruction execution is completed ◆ <i>Done</i> changes to TRUE when the instruction execution is completed after <i>Execute</i> changes from TRUE to FALSE during the instruction execution. One cycle later, <i>Done</i> changes to FALSE.
Busy	◆ When <i>Execute</i> changes to TRUE.	◆ When <i>Done</i> changes to TRUE ◆ When <i>Error</i> changes to TRUE ◆ When <i>CommandAbort</i> changes to TRUE
Active	◆ When axes start being controlled by the instruction.	◆ When <i>Done</i> changes to TRUE ◆ When <i>Error</i> changes to TRUE ◆ When <i>CommandAbort</i> changes to TRUE

Name	Timing for changing to TRUE	Timing for changing to FALSE
CommandAbort	◆ When the instruction execution is aborted by other motion instruction.	◆ When <i>Execute</i> changes from TRUE to FALSE
Error	◆ When an error occurs in the instruction execution or the input parameters for the instruction are illegal.	◆ When <i>Execute</i> changes from TRUE to FALSE

● Output Update Timing Chart

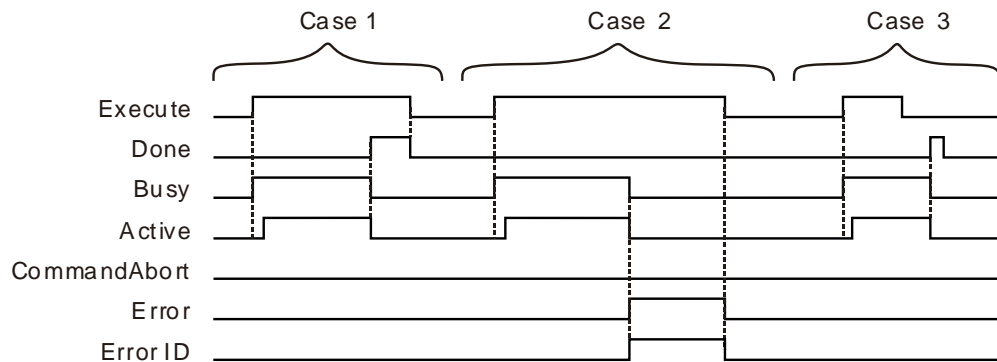

Case 1 : When *Execute* changes from FALSE to TRUE, *Busy* changes to TRUE. Three cycles later, *Active* changes to TRUE. When the axes group reaches the end position, *Done* changes to TRUE, *Busy* and *Active* change to FALSE.

Case 2 : When *Execute* changes from FALSE to TRUE and an error occurs (such as error in state machine of the axes group), *Error* changes to TRUE and *ErrorID* shows corresponding error codes and meanwhile *Busy* and *Active* change to FALSE. When *Execute* changes from TRUE to FALSE, *Error* changes to FALSE.

Case 3 : After *Execute* changes from TRUE to FALSE in the instruction execution, *Done* changes to TRUE when the instruction execution is completed. Meantime *Busy* and *Active* change to FALSE. One cycle later, *Done* changes to FALSE.

● Function

DMC_MoveCircularRelative is used for axes to perform the circular interpolation. The firmware of V1.01 and above supports the function.

■ CirMode (Circular interpolation mode)

There are six CirMode modes as follows.

CirMode value	Description
0	Draw an arc via the center on XY plane. AuxPoint[1] is the offset value of the center on basis of the start point on X-axis. AuxPoint[2] is the offset value of the center on basis of the start point on Y-axis.

11

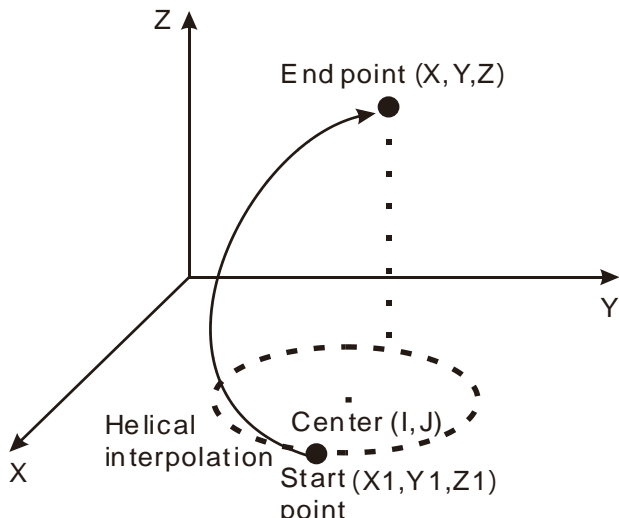
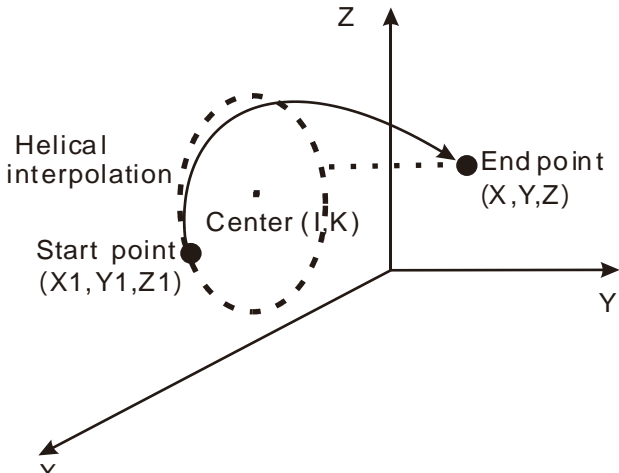
CirMode value	Description
	 <p>In the figure above, Coordinates for the center: $I=X1+AuxPoint[1]$, $J=Y1+AuxPoint[2]$, Coordinates for the end point: $X=X1+EndPoint[1]$, $Y=Y1+EndPoint[2]$ · $Z=Z1+EndPoint[3]$.</p>
1	<p>Draw an arc via the center on ZX plane. AuxPoint[1] is the offset value of the center on basis of the start point on X-axis. AuxPoint[2] is the offset value of the center on basis of the start point on Z-axis.</p>  <p>Coordinates for the center: $I=X1+AuxPoint[1]$ · $K=Z1+AuxPoint[2]$ ° Coordinates for the end point: $X=X1+EndPoint[1]$, $Y=Y1+EndPoint[2]$, $Z=Z1+EndPoint[3]$.</p>
2	<p>Draw an arc via the center on YZ plane. AuxPoint[1] is the offset value of the center on basis of the start point on Y-axis. AuxPoint[2] is the offset value of the center on basis of the start point on Z-axis.</p>

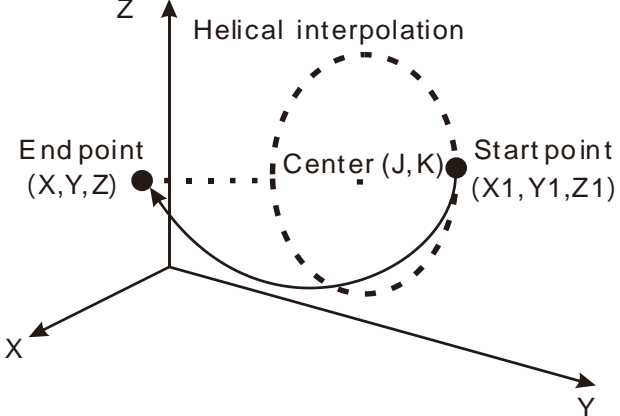
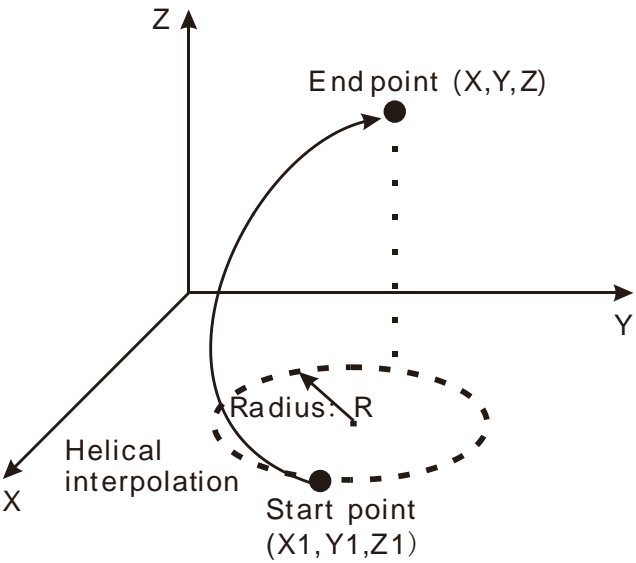
CirMode value	Description
	 <p data-bbox="486 728 1284 840">Coordinates for the center: $J=Y1+AuxPoint[1] \cdot K=Z1+AuxPoint[2]$ ° Coordinates for the end point: $X=X1+EndPoint[1] \cdot Y=Y1+EndPoint[2] \cdot Z=Z1+EndPoint[3]$ °</p>
3	<p data-bbox="486 851 1444 974">Draw an arc via the radius on XY plane. The value of AuxPoint[1] is the radius of the circle on XY plane and here the value of AuxPoint[2] is meaningless. If the value of AuxPoint[1] is greater than 0, it is a <u>minor arc</u>. If the value of AuxPoint[1] is less than 0, it is a <u>major arc</u>.</p>  <p data-bbox="486 1601 1268 1691">In the figure above, Radius: $R=AuxPoint[1]$, Coordinates for end point: $X=X1+EndPoint[1]$, $Y=Y1+EndPoint[2]$, $Z=Z1+EndPoint[3]$.</p>
4	<p data-bbox="486 1695 1444 1753">Draw an arc via the radius on ZX plane. The value of AuxPoint[1] is the radius of the circle on ZX plane and here the value of AuxPoint[2] is meaningless.</p>

11

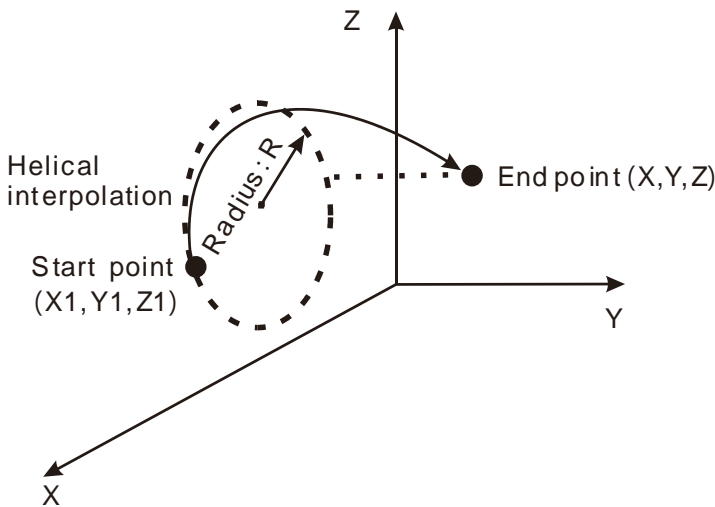
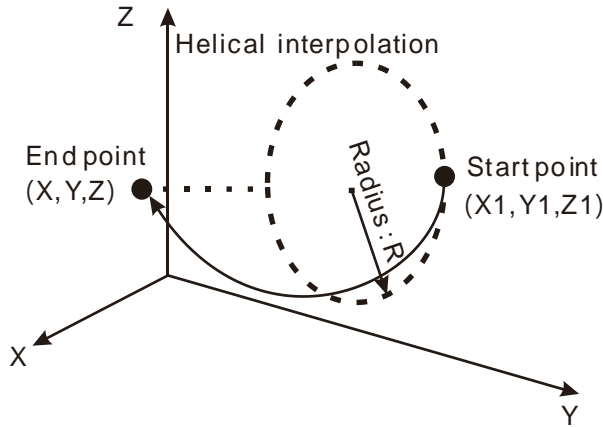
CirMode value	Description
	 <p>In the figure above, Radius: $R = \text{AuxPoint}[1]$. Coordinates for end point: $X = X1 + \text{EndPoint}[1]$ · $Y = Y1 + \text{EndPoint}[2]$ · $Z = Z1 + \text{EndPoint}[3]$.</p>
5	<p>Draw an arc via the radius on ZY plane. The value of AuxPoint[1] is the radius of the circle on ZY plane and here the value of AuxPoint[2] is meaningless.</p>  <p>In the figure above, Radius: $R = \text{AuxPoint}[1]$ Coordinates for end point: $X = X1 + \text{EndPoint}[1]$, $Y = Y1 + \text{EndPoint}[2]$, $Z = Z1 + \text{EndPoint}[3]$</p>

■ PathChoice

The parameter determines the direction for circular interpolation. See the details as follows.

PathChoice value	Description
0	The axes group conducts circular interpolation in the clockwise direction on the arcs of the specified plane. Take the radius method for example, the path for the circular motion is shown as below.

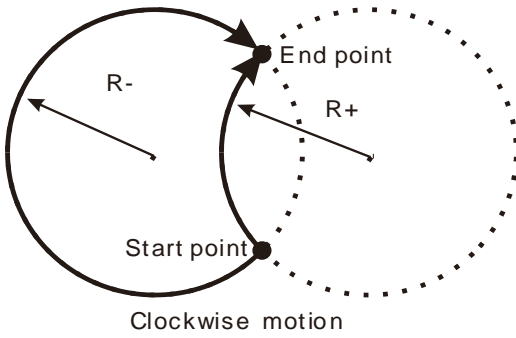
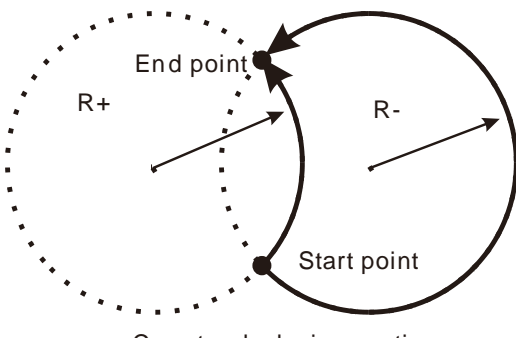
PathChoice value	Description
	 <p>Clockwise motion</p>
1	<p>The axes group conducts circular interpolation in the anticlockwise direction on the arcs of the specified plane. Take the radius method for example, the path for the circular motion is shown as below.</p>  <p>Counterclockwise motion</p>

■ BufferMode

Specify the buffer mode between current instruction and previous interpolation instruction. See the details as follows.

BufferMode Value	Description
mcBuffered (1)	Current instruction will wait and not be executed till the previous interpolation instruction execution is finished.
mcBlendingPrevious (3)	The transition between current instruction and previous interpolation instruction is conducted in the mode specified by <i>TransitionMode</i> . The <i>BufferMode</i> of DMC_MoveCircularRelative can select this mode only when current instruction is a linear interpolation instruction.



Programming Example

The example of executing one DMC_MoveCircularRelative instruction is shown as follows.

1. The variable table and program

Variable name	Data type	Initial value
M1	BOOL	
ADDAXIS1	DMC_AddAxisToGroup	
ADDAXIS1_Ex	BOOL	
ADDAXIS1_Done	BOOL	
ADDAXIS1_Bsy	BOOL	
ADDAXIS1_Err	BOOL	
ADDAXIS1_ErrID	WORD	

Variable name	Data type	Initial value
ADDAXIS2	DMC_AddAxisToGroup	
ADDAXIS2_Done	BOOL	
ADDAXIS2_Bsy	BOOL	
ADDAXIS2_Err	BOOL	
ADDAXIS2_ErrID	WORD	
DMC_GroupEnable0	DMC_GroupEnable	
GE_En	BOOL	
GE_Vel	ARRAY [1..8] OF LREAL	
GE_Acc	ARRAY [1..8] OF LREAL	
GE_Dec	ARRAY [1..8] OF LREAL	
GE_Jerk	ARRAY [1..8] OF LREAL	
GE_Status	BOOL	
GE_Bsy	BOOL	
GE_Abt	BOOL	
GE_Err	BOOL	
GE_ErrID	WORD	
CIRREL	DMC_MoveCircularRelative	
CIRREL_Ex	BOOL	
CIRREL_Mode	INT	0
CIRREL_Auxp	ARRAY [1..2] OF LREAL	
CIRREL_Endp	ARRAY [1..8] OF LREAL	
CIRREL_T	UINT	0
CIRREL_PC	INT	0
CIRREL_Done	BOOL	
CIRREL_Bsy	BOOL	
CIRREL_Act	BOOL	
CIRREL_Abt	BOOL	
CIRREL_Err	BOOL	
CIRREL_ErrID	WORD	

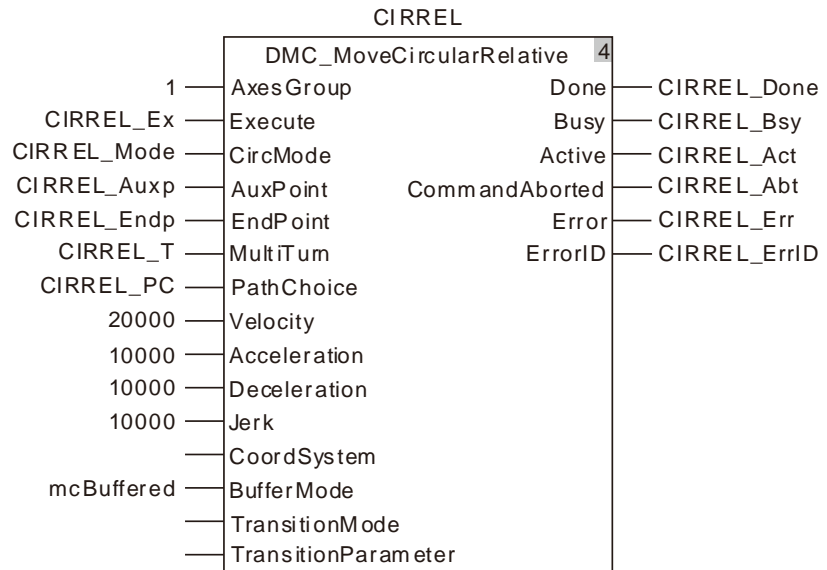
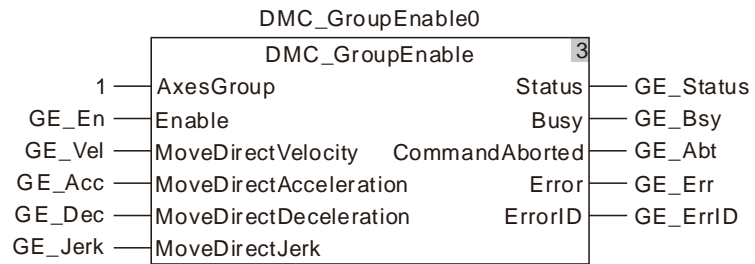
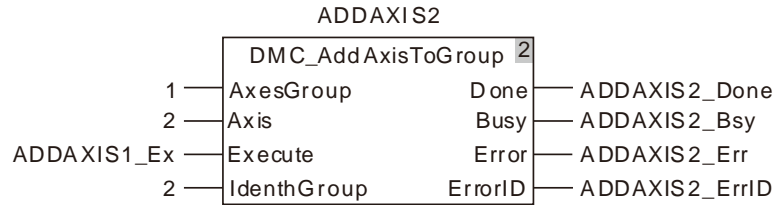
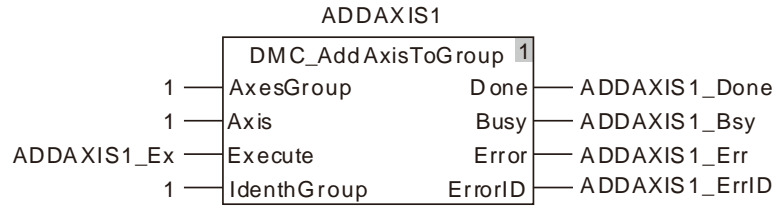

2. Motion Curve in the X-Y coordinate system and Timing Chart

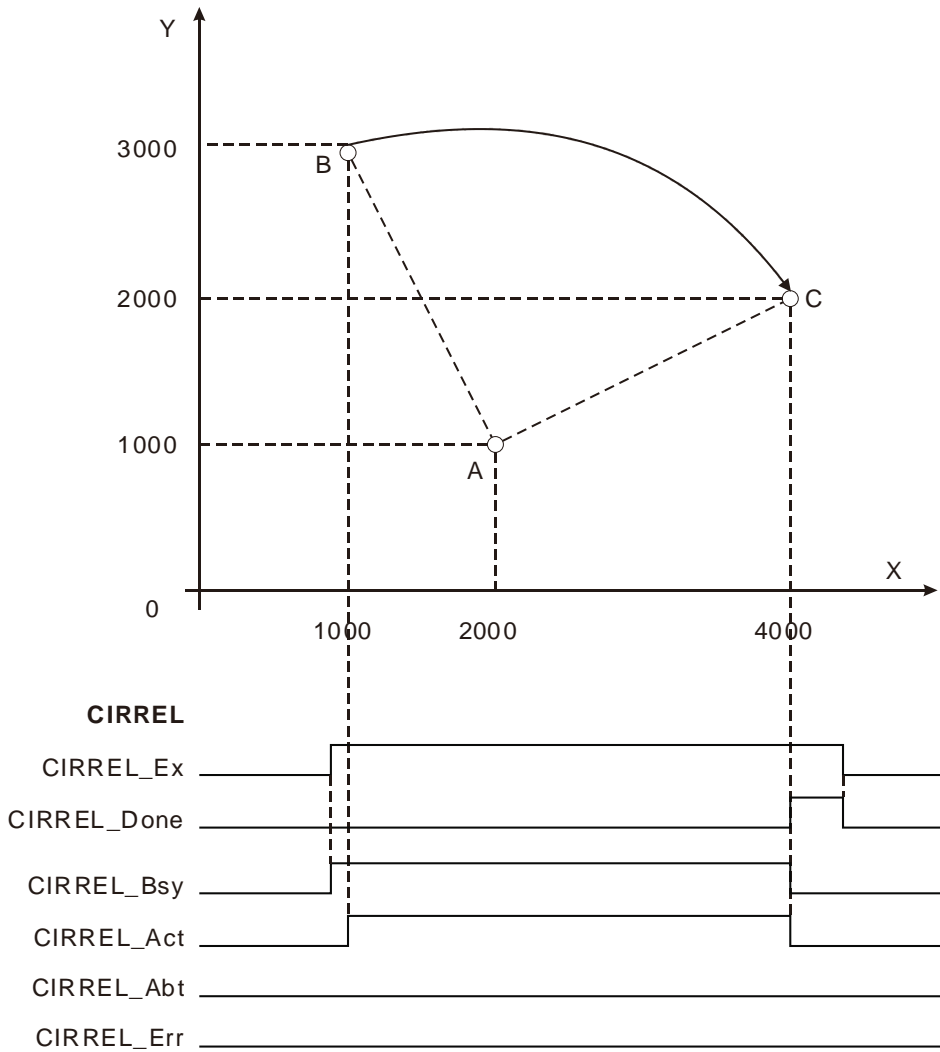

- ❖ The value of CIRREL_Mode is set to 0. The value of CIRREL_Auxp[1] is set to 1000. The value of CIRREL_Auxp[2] is set to -2000. The value of CIRREL_Endp[1] is set to 3000. The value of CIRREL_Endp[2] is set to -1000. The value of CIRREL_Mode is set to 0.
- ❖ Point B is the start point of the arc with coordinates (1000, 3000). Point A is the center of the circle where the arc is with the coordinates (1000+CIRREL_Auxp[1]=2000, 3000+CIRREL_Auxp[2]=1000). Point C is the end point of the arc with coordinates (1000+CIRREL_Endp[1]=4000, 3000+CIRREL_Endp[2]=2000).
- ❖ After DMC_MoveCircularRelative instruction is executed, the clockwise circular interpolation is conducted by starting from point B and regarding point A as the center. The instruction execution is finished when point C is reached.

11.7.14 DMC_GroupSetOverride

FB/FC	Explanation	Applicable model
FB	DMC_GroupSetOverride instruction is used to set the value of override for the coordinated motion of an axes group.	DVP15MC11T DVP15MC11T-06

DMC_GroupSetOverride_instance

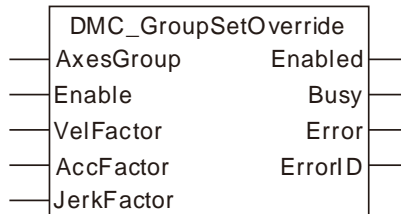

● Input Parameters

Parameter name	Function	Data type	Valid range (Default)	Validation timing
AxesGroup	The axes group number	USINT	1~8 (The variable value must be set)	When <i>Enable</i> changes to TRUE.
Enable	The instruction is executed when <i>Enable</i> changes from FALSE to TRUE.	BOOL	TRUE or FALSE (FALSE)	
VelFactor	Override value, unit: %, e.g. "100" means 100%.	LREAL	0~500 (The variable value must be set)	When <i>Enable</i> changes to TRUE.
AccFactor	Reserved	-	-	-
JerkFactor	Reserved	-	-	-

● Output Parameters

Parameter name	Function	Data type	Valid range
Enabled	TRUE when the axes group is being controlled.	BOOL	TRUE / FALSE
Busy	TRUE when the instruction is being executed.	BOOL	TRUE / FALSE
Error	TRUE when an error occurs in execution of the instruction.	BOOL	TRUE / FALSE
ErrorID	Contains the error code when an error occurs. Please refer to section 12.2.	WORD	

● **Output Update Timing**

Name	Timing for changing to TRUE	Timing for changing to FALSE
Enabled	◆ When the instruction starts being executed.	◆ When <i>Enable</i> changes to FALSE ◆ When <i>Error</i> changes to TRUE
Busy	◆ When <i>Enable</i> changes to TRUE	◆ When <i>Enable</i> changes to FALSE ◆ When <i>Error</i> changes to TRUE
Error	◆ When an error occurs in the instruction execution or the input parameters for the instruction are illegal.	◆ When <i>Enable</i> changes from TRUE to FALSE

● **Output Update Timing Chart**

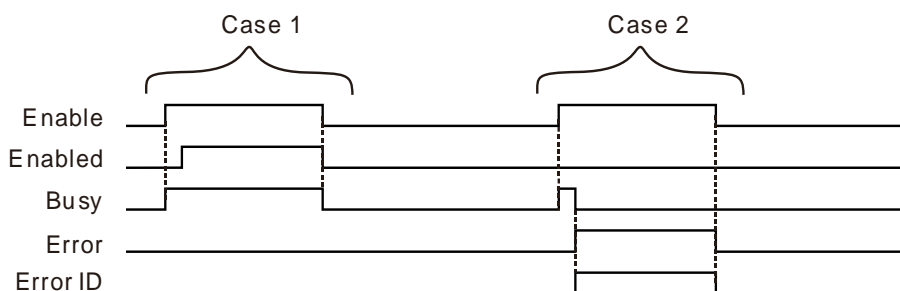

Case 1 : When *Enable* changes from FALSE to TRUE, *Busy* changes to TRUE. One cycle later, *Enabled* changes to TRUE. When *Enable* changes from TRUE to FALSE, *Enabled* and *Busy* change to FALSE.

Case 2 : When an error occurs in the instruction execution, *Error* changes to TRUE and *ErrorID* shows corresponding error codes and meanwhile *Busy* changes to FALSE. When *Enable* changes to FALSE, *Error* changes to FALSE and the value in *ErrorID* is cleared to 0.

● **Function**

DMC_GroupSetOverride instruction is used to set the value of override for the coordinated motion of a axes group. The firmware of V1.01 and above supports the function.

1. The target velocities of these instructions can be changed including DMC_MoveDirectAbsolute, DMC_MoveDirectRelative, DMC_MoveLinearAbsolute, DMC_MoveLinearRelative, DMC_MoveCircularAbsolute and DMC_MoveCircularRelative.
2. The unit of *VelFactor* is %. “100” means “100%”. The valid range of *VelFactor* value is 0~500. If the range is exceeded, an error will occur in the instruction execution.
3. The target velocities of axes in the axes group = target velocities of current axes * override value if the instruction DMC_MoveDirectAbsolute or DMC_MoveDirectRelative is being executed after the DMC_GroupSetOverride instruction is executed.
The new maximum velocity of the axes group = current maximum velocity of the axes group* override value if the instruction DMC_MoveLinearAbsolute, DMC_MoveLinearRelative, DMC_MoveCircularAbsolute or DMC_MoveCircularRelative is being executed after the DMC_GroupSetOverride instruction is executed.
4. After DMC_GroupSetOverride instruction is executed, the axes group will accelerate or decelerate according to the acceleration rate or deceleration rate of currently being executed instruction till the target velocity after modification is reached.
5. An error will occur in axes if the target velocity after modification exceeds the maximum rotation velocity.
6. The target velocity becomes 0 and the axes group acts at the velocity 0 when the value of *VelFactor* is set 0.
7. When *Enable* changes to TRUE, the newly modified *VelFactor* value will take effect immediately and

users do not need to restart the instruction. When *Enable* changes to TRUE, an error will occur in the instruction and the target velocity will return to 100% if the value of *VelFactor* exceeds valid range.

8. When *Enable* changes to TRUE, the modified value of *VelFactor* will take effect immediately and there will be no need to restart the instruction. When *Enable* changes to TRUE, an error will be alerted immediately in the instruction and the target velocity will return to 100% if the modified value of *VelFactor* exceeds valid range.
9. When *Enable* changes to FALSE, the axes group will speed up or slow down regarding *VelFactor*=100 as the target.



Programming Example

The example of executing DMC_GroupSetOverride instruction is as follows.

1. The variable table and program

Variable name	Data type	Initial value
M1	BOOL	
SetOv	DMC_GroupSetOverride	
SetOv_En	BOOL	
SetOv_Velf	LREAL	
SetOv_Ena	BOOL	
SetOv_Bsy	BOOL	
SetOv_Err	BOOL	
SetOv_ErrID	WORD	
LINABS	DMC_MoveLinearAbsolute	
LINABS_Ex	BOOL	
LINABS_Pos	ARRAY [1..8] OF LREAL	
LINABS_Done	BOOL	
LINABS_Bsy	BOOL	
LINABS_Act	BOOL	
LINABS_Abt	BOOL	
LINABS_Err	BOOL	
LINABS_Eid	WORD	



2. Motion Curve and Timing Chart

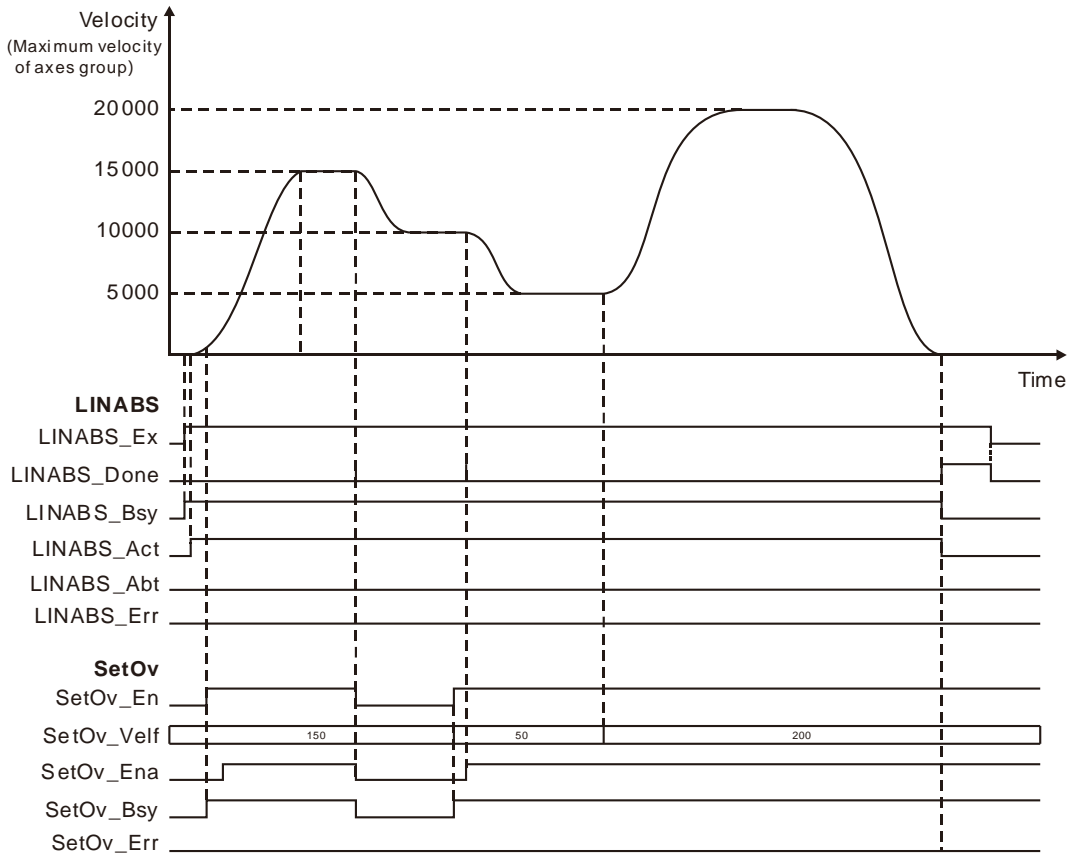

- ❖ When LINABS_Ex changes to TRUE, LINABS_Bsy changes to TRUE. Two cycles later, LINABS_Act changes to TRUE and the axes group starts to move. When the axes group has not reached the target velocity and SetOv_En is set to TRUE, the DMC_GroupSetOverride instruction takes effect and the target velocity of the axes group becomes the new target velocity.
- ❖ When SetOv_En changes to FALSE, the target velocity of the axes group becomes 10,000.
- ❖ If the value of SetOv_Velf is modified in the execution of DMC_GroupSetOverride instruction, the value of SetOv_Velf will take effect immediately. The target velocity of the DMC_MoveLinearAbsolute instruction will change accordingly.

11.7.15 DMC_GroupReadActualPosition

FB/FC	Explanation	Applicable model
FB	DMC_GroupReadActualPosition instruction can be used to read the position of axes in the axes group.	DVP15MC11T DVP15MC11T-06

DMC_GroupReadActualPosition_instance

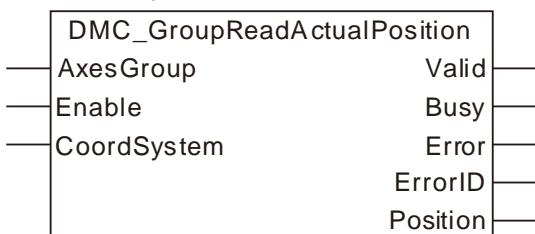

● Input Parameters

Parameter name	Function	Data type	Valid range (Default)	Validation timing
AxesGroup	The axes group number	USINT	1~8 (The variable value must be set)	When <i>Enable</i> changes to TRUE.
Enable	The instruction is executed when <i>Enable</i> changes from FALSE to TRUE.	BOOL	TRUE or FALSE (FALSE)	
CoorSystem	Reserved	-	-	-

● Output Parameters

Parameter name	Function	Data type	Valid range
Valid	TRUE when the output of the instruction is valid.	BOOL	TRUE / FALSE
Busy	TRUE when the instruction is being executed.	BOOL	TRUE / FALSE
Error	TRUE when an error occurs in execution of the instruction.	BOOL	TRUE / FALSE
ErrorID	Contains the error code when an error occurs. Please refer to section 12.2.	WORD	
Position	Positions of axes in an axis group	ARRAY [1..8] OF LREAL	

● Output Update Timing

Name	Timing for changing to TRUE	Timing for changing to FALSE
Valid	◆ When the instruction reads the positions of axes in the axes group	◆ When <i>Enable</i> changes from TRUE to FALSE ◆ When <i>Error</i> changes to TRUE
Busy	◆ When the instruction is executed	◆ When <i>Enable</i> changes from TRUE to FALSE ◆ When <i>Error</i> changes to TRUE
Error	◆ When an error occurs in the instruction execution or the input parameters for	◆ When <i>Enable</i> changes from TRUE to FALSE

Name	Timing for changing to TRUE	Timing for changing to FALSE
	the instruction are illegal.	

- **Output Update Timing Chart**

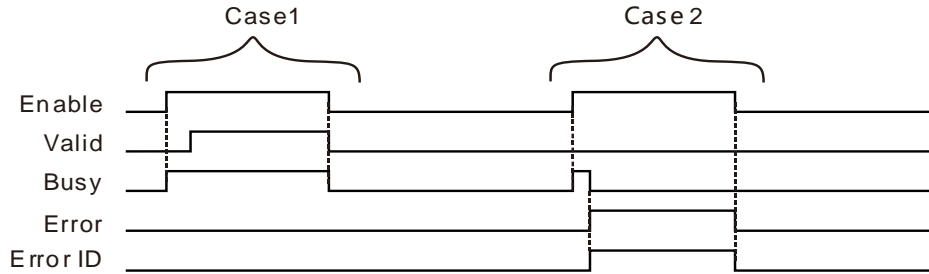

Case 1 : When *Enable* changes from FALSE to TRUE, *Busy* changes to TRUE. One cycle later, *Valid* changes to TRUE. When *Enable* changes from TRUE to FALSE, *Valid* and *Busy* change to FALSE simultaneously.

Case 2 : When there is an input error in the instruction and *Enable* changes from FALSE to TRUE, *Busy* changes to TRUE, one cycle later, *Error* changes to TRUE and *ErrorID* shows error codes and meanwhile *Busy* changes to FALSE. When *Enable* changes from TRUE to FALSE, *Error* changes to FALSE and the value in *ErrorID* is cleared to 0.

- **Function**

DMC_GroupReadActualPosition instruction is used to read current positions of axes in the axes group. The value of the output *Position* is an array. Every member of the array corresponds to one axis position. E.g. *Position*[1] corresponds to the position on X-axis, *Position*[2] corresponds to the position on Y-axis and so on. The firmware of V1.01 and above supports the function.

11.8 Coordination Instructions

11.8.1 DMC_ControlAxisByPos

11

FB/FC	Explanation	Applicable model
FB	DMC_ControlAxisByPos controls the motion of an axis by sending an incremental position to the axis.	DVP15MC11T DVP15MC11T-06

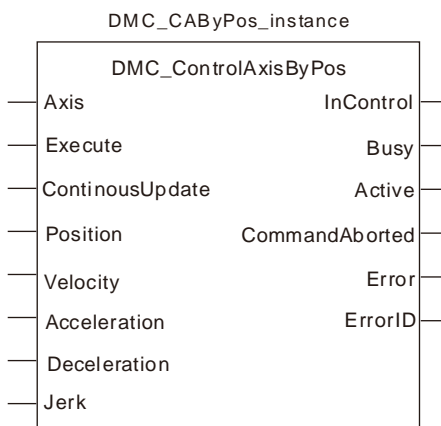

● **Input Parameters**

Parameter name	Function	Data type	Valid range (Default)	Validation timing
Axis	Specify the number of the axis which is to be controlled.	USINT	Refer to " <u>Axis No. Ranges that Controllers Correspond to</u> ". (The variable value must be set)	When <i>Execute</i> changes from FALSE to TRUE
Execute	The instruction is executed when <i>Execute</i> changes from FALSE to TRUE.	BOOL	TRUE or FALSE (FALSE)	-
ContinuousUpdate	Reserved	-	-	-
Position	Specify the incremental position.	LREAL	Positive number, Negative number and 0 (0)	When <i>Execute</i> changes from FALSE to TRUE
Velocity	Specify the target speed	LREAL	Positive number (The variable value must be set)	
Acceleration	Specify the target acceleration.	LREAL	Positive number (The variable value must be set)	
Deceleration	Specify the target deceleration.	LREAL	Positive number (The variable value must be set)	
Jerk	Specify the change rate of target acceleration or	LREAL	Positive number (The variable	

Parameter name	Function	Data type	Valid range (Default)	Validation timing
	deceleration.		value must be set)	

● **Output Parameters**

Parameter name	Function	Data type	Valid range
InControl	TRUE when the axis is under control of the instruction.	BOOL	TRUE/FALSE
Busy	TRUE when the instruction is being executed.	BOOL	TRUE/FALSE
Active	TRUE when the axis is being controlled by the instruction.	BOOL	TRUE/FALSE
CommandAborted	TRUE when the instruction execution is aborted.	BOOL	TRUE/FALSE
Error	TRUE when an error occurs in the instruction execution.	BOOL	TRUE/FALSE
ErrorID	Contains error codes when an error occurs. Please refer to the section 12.2 for corresponding error codes.	WORD	

● **Output Update Timing**

Parameter Name	Timing for changing to TRUE	Timing for changing to FALSE
InControl	◆ When the axis is controlled by the instruction.	◆ When <i>Execute</i> changes from TRUE to FALSE.
Busy	◆ When <i>Execute</i> changes to TRUE.	◆ When <i>CommandAborted</i> changes to TRUE. ◆ When <i>Error</i> changes to TRUE.
Active	◆ When the instruction starts to control the axis.	◆ When <i>CommandAborted</i> changes to TRUE. ◆ When <i>Error</i> changes to TRUE.
CommandAborted	◆ When this instruction is aborted in process of being executed.	◆ When <i>Execute</i> changes from TRUE to FALSE.
Error	◆ When an error occurs in the instruction execution or the input parameters for the instruction are illegal.	◆ When <i>Execute</i> changes from TRUE to FALSE.

● **Output Update Timing Chart**

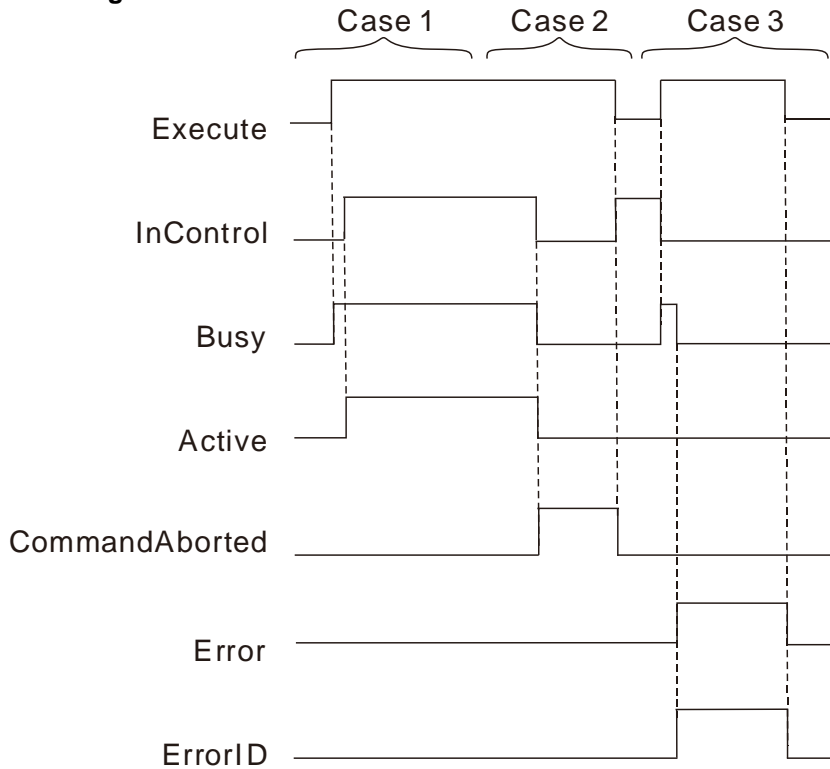

Case 1 : *Busy* changes to TRUE when *Execute* changes to TRUE. Several cycles later, *Active* and *InControl* change to TRUE.

Case 2 : When *Execute* changes from FALSE to TRUE and the instruction is aborted by other instruction, *CommandAborted* changes to TRUE and meanwhile *Busy* and *Active* change to FALSE. *CommandAborted* changes to FALSE when *Execute* changes from TRUE to FALSE.

Case 3 : When an error occurs such as axis alarm or Offline after *Execute* changes from FALSE to TRUE, *Error* changes to TRUE and *ErrorID* shows corresponding error codes. Meanwhile, *Busy* and *Active* change to FALSE and *InControl* changes to FALSE. *Error* changes to FALSE when *Execute* changes from TRUE to FALSE.

● **Function**

1. DMC_ControlAxisByPos instruction is executed by changing *Execute* from FALSE to TRUE. Changing *Execute* of the instruction from TRUE to FALSE during the instruction execution does not affect the instruction execution.
2. While *Execute* changes from FALSE to TRUE once more during the execution of DMC_ControlAxisByPos, there is still no impact on the instruction execution.
3. The velocity, acceleration and deceleration must be greater than 0. None of them are used in the calculation of the position control.
4. The *Position* in this instruction means a relative incremental position. The reference position for the incremental position is what the value of *Position* is when *Execute* of the instruction changes from FALSE to TRUE.

For example, the value of *Position* is 5000 and the axis position is 500. Change *Execute* of the instruction from FALSE to TRUE. Then the axis remains motionless and the axis position remains unchanged. Change the value of *Position* to 6000 (which has increased by 1000), the axis completes

the motion in one SYNC cycle. The axis position is 1500 (which has increased by 1000) after the travel is completed.



Programming Example

The programming example is as follows when one DMC_ControlAxisByPos instruction is used.

Variable name	Data type	Initial value
Pwr	MC_Power	
Axis1	USINT	1
Pwr_Sta	BOOL	FALSE
Pwr_Bsy	BOOL	FALSE
Pwr_Act	BOOL	FALSE
Pwr_Err	BOOL	FALSE
Pwr_ErrID	WORD	0
CAByPos	DMC_ControlAxisByPos	
CAByPos_Ex	BOOL	FALSE
CAByPos_Ex_Pos	LREAL	
CAByPos_Ex_Vel	LREAL	1
CAByPos_Ex_Acc	LREAL	1
CAByPos_Ex_Dec	LREAL	1
CAByPos_Ex_Jerk	LREAL	1
CAByPos_InC	BOOL	FALSE
CAByPos_Bsy	BOOL	FALSE
CAByPos_Act	BOOL	FALSE
CAByPos_Abt	BOOL	FALSE
CAByPos_Err	BOOL	FALSE
CAByPos_ErrID	WORD	0

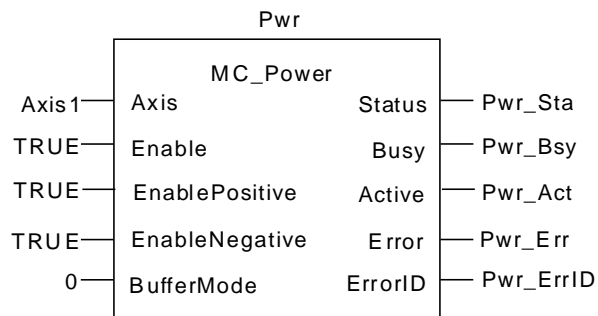

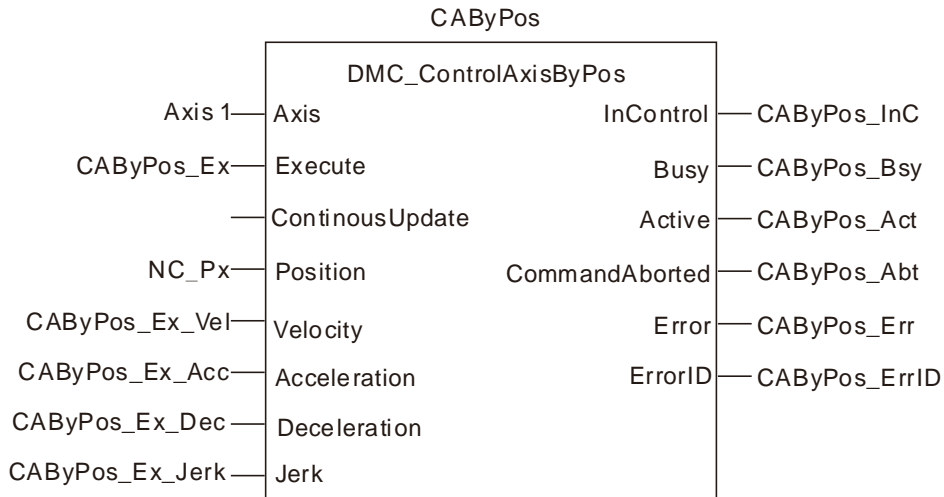

CAByPos_Ex changes to TRUE after the axis is power on. Meanwhile CAByPos_Bsy is TRUE in the same cycle. CAByPos_Act is TRUE in the next cycle. Then increase the value of CAByPos_Ex_Pos by 10 per cycle. Suppose the SYNC cycle is 2ms, there are 500 SYNC cycles within 1 second and the axis command velocity is $10 \times 500 = 5000$ units/second.

11.8.2 DMC_NC

FB/FC	Explanation	Applicable model
FB	DMC_NC Instruction is used to parse out the position of each axis in the CNC file every SYNC cycle.	DVP15MC11T DVP15MC11T-06

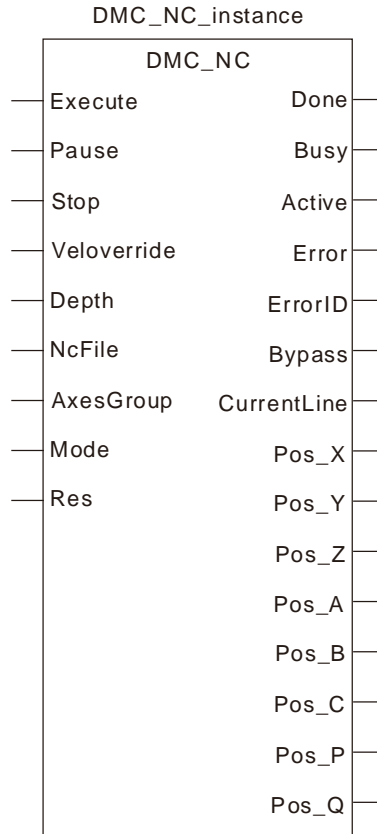

● Input Parameters

Parameter name	Function	Data type	Valid range (Default)	Validation timing
Execute	The instruction is executed when <i>Execute</i> changes from FALSE to TRUE.	BOOL	TRUE or FALSE (FALSE)	-
Pause	Parsing the CNC file by DMC_NC is stopped temporarily when <i>Pause</i> changes from FALSE to TRUE.	BOOL -	TRUE or FALSE (FALSE) -	-
Stop	Parsing the CNC file by DMC_NC is aborted when <i>Stop</i> changes from FALSE to TRUE.	BOOL	TRUE or FALSE (FALSE)	
VelOverride	Velocity override, Unit: %, e.g. "100" means 100%	LREAL	Negative, 0-500 (0)	When <i>Execute</i> is TRUE
Depth	Enter 1 here; Reserved.	LREAL	1-50 (0)	When <i>Execute</i> changes from FALSE to TRUE

Parameter name	Function	Data type	Valid range (Default)	Validation timing
NCFile	CNC file Number	LREAL	1-64 (0)	When <i>Execute</i> changes from FALSE to TRUE
AxesGroup	The number of an axes group	LREAL	1-8 (0)	When <i>Execute</i> changes from FALSE to TRUE
Mode	Enter 0 here; Reserved.			
Res	Reserved			

● **Output Parameters**

Parameter name	Function	Data type	Valid range
Done	TRUE when parsing the CNC file is complete.	BOOL	TRUE/FALSE
Busy	TRUE when the instruction is being executed.	BOOL	TRUE/FALSE
Active	TRUE when the instruction is parsing the CNC file.	BOOL	TRUE/FALSE
Error	TRUE when an error occurs in the instruction execution.	BOOL	TRUE/FALSE
ErrorID	Contains the error code when an error occurs. Please refer to section 12.2.	WORD	
Bypass	Reserved	BOOL	
CurrentLine	The number of the row where the G code is being executed currently.	UDINT	
Pos_X	The X-axis position which is parsed out	LREAL	
Pos_Y	The Y-axis position which is parsed out	LREAL	
Pos_Z	The Z-axis position which is parsed out	LREAL	
Pos_A	The A-axis position which is parsed out	LREAL	
Pos_B	The Baxis position which is parsed out	LREAL	
Pos_C	The C-axis position which is parsed out	LREAL	
Pos_P	The P-axis position which is parsed out	LREAL	
Pos_Q	The Q-axis position which is parsed out	LREAL	

● **Output Update Timing**

Parameter Name	Timing for changing to TRUE	Timing for changing to FALSE
Done	<ul style="list-style-type: none"> ◆ When parsing the CNC file is over. ◆ The <i>Stop</i> input changes to TRUE. 	<ul style="list-style-type: none"> ◆ When <i>Execute</i> changes from TRUE to FALSE.
Busy	<ul style="list-style-type: none"> ◆ When <i>Execute</i> changes to TRUE. 	<ul style="list-style-type: none"> ◆ When <i>Error</i> changes to TRUE. ◆ When <i>Done</i> changes to TRUE.
Active	<ul style="list-style-type: none"> ◆ When the instruction starts parsing the CNC file. 	<ul style="list-style-type: none"> ◆ When <i>Error</i> changes to TRUE. ◆ When <i>Done</i> changes to TRUE.
Error	<ul style="list-style-type: none"> ◆ When an error occurs in the instruction execution or the input parameters for the instruction are illegal. 	<ul style="list-style-type: none"> ◆ When <i>Execute</i> changes from TRUE to FALSE.

● **Output Update Timing Chart**

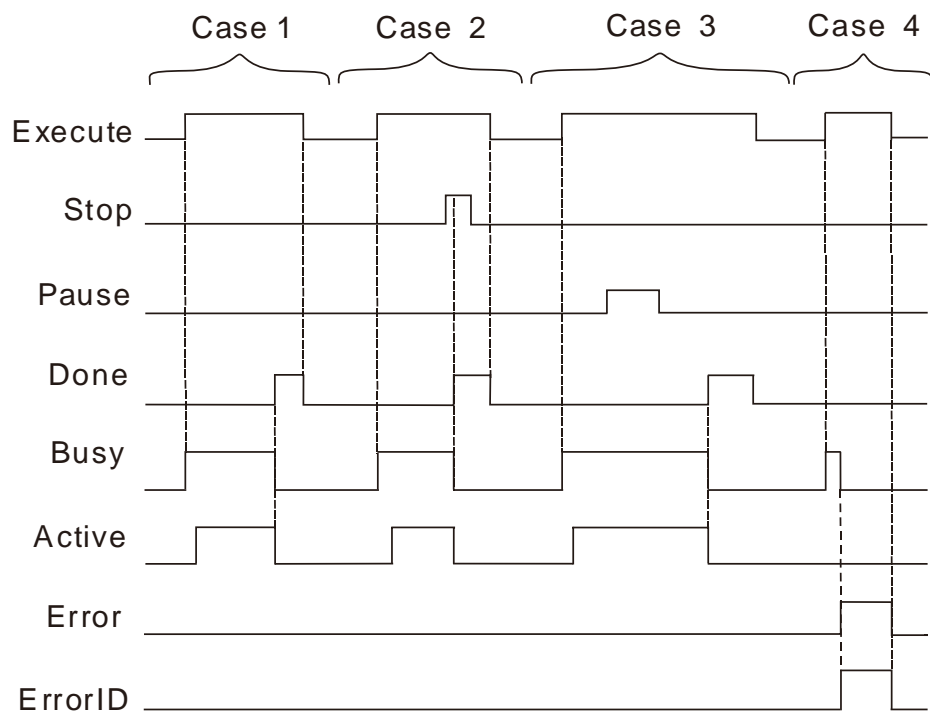

Case 1 : *Busy* changes to TRUE when *Execute* changes to TRUE. Several cycles later, *Active* changes to TRUE. When parsing the CNC file is complete, *Done* changes to TRUE. Meanwhile *Busy* and *Active* change to FALSE. When *Execute* changes to FALSE, *Done* changes to FALSE.

Case 2 : *Busy* changes to TRUE when *Execute* changes to TRUE. Several cycles later, *Active* changes to TRUE. Change the state of *Stop* to TRUE while the CNC file is being parsed. In the next cycle, *Done* changes to TRUE, meanwhile *Busy* and *Active* change to FALSE, the CNC file parsing ends and *CurrentLine* and axis position outputs stop. Changing the state of *Stop* to FALSE, *Done* remains TRUE. When *Execute* changes to FALSE, *Done* changes to FALSE.

Case 3 : *Busy* changes to TRUE when *Execute* changes to TRUE. Several cycles later, *Active* changes to TRUE. change the state of *Pause* to TRUE while the CNC file is being parsed. The instruction stops parsing the CNC file temporarily and *CurrentLine* and axis position outputs stop. Changing

the state of *Pause* to FALSE, the parsing of the CNC file continues and *CurrentLine* and axis position outputs are recovered. When the *parsing* is complete, *Done* changes to TRUE. Meanwhile *Busy* and *Active* change to FALSE. *Done* changes to FALSE by changing *Execute* to FALSE.

11

Case 4 : When *Execute* changes to TRUE and one of the parameter values for the instruction is incorrect, *Busy* changes to TRUE. One cycle later, *Error* changes to TRUE, *ErrorID* outputs error ID and *Busy* changes to FALSE. When *Execute* changes to FALSE, *Error* changes to FALSE and the value of *ErrorID* changes to 0.

Function

DMC_NC Instruction is used to parse the CNC file.

The instruction analyzes the position of each axis and outputs each axis position to corresponding output parameters of the instruction (e.g. Pos_X, Pos_Y, etc.) every SYNC cycle. Actually the values of Pos_X and Pos_Y do not control the axes and they are only the positions which are parsed out. If you want to control any axis through this instruction, the position which is parsed out by the instruction can be assigned to *Position* of the DMC_ControlAxisByPos instruction by using the DMC_NC instruction together with the DMC_ControlAxisByPos instruction. By doing so, the axis motion can be controlled according to the path planned in the CNC file.

1. The DMC_NC Instruction is executed by changing *Execute* from FALSE to TRUE. There is no impact on the instruction execution by changing *Execute* of the instruction from TRUE to FALSE in the course of the instruction execution.
2. Changing *Execute* from FALSE to TRUE once more during the execution of DMC_NC Instruction does not affect the instruction execution.
3. By setting *Stop* to TRUE during the DMC_NC instruction execution, the CNC file parsing will end and *Done* changes to TRUE.
4. By setting *Pause* to TRUE during the DMC_NC instruction execution, the CNC file parsing will stop for a while and will continue after *Pause* is set to FALSE.
5. The *NCFfile* input specifies the number of the CNC file to be executed, i.e. it is the ID of the CNC file created in the programming software.
6. The *AxesGroup* input specifies the number of the axes group which is to execute the CNC file.



Programming Example

Axes are controlled to move according to the path planned in the CNC file by using DMC_NC and DMC_ControlByPos instructions. Axis 1 and axis 2 are configured in the program. The initial positions of the two axes are both 10000 units. Axis 1 is X axis and axis 2 is Y axis.

A new CNC file is created in the program with the file ID set to 1.

See the program as follows.

```
N00 G91
N01 G0 X40000 Y90000
```

CNC file execution result:

After G91 is executed, the end position of each axis in the G codes below G91 is calculated by the incremental value starting from the current position. After G0 is executed, X axis moves 40000 units from the current position (10000) to the end position (50000). Y axis moves 90000 units from current position (10000) to end position (100000)

Variable name	Data type	Initial value
CAByPos	DMC_ControlAxisByPos	
Axis1	USINT	1

Variable name	Data type	Initial value
CAByPos_Ex	BOOL	FALSE
CAByPos_Ex_Vel	LREAL	1
CAByPos_Ex_Acc	LREAL	1
CAByPos_Ex_Dec	LREAL	1
CAByPos_Ex_Jerk	LREAL	1
CAByPos_InC	BOOL	FALSE
CAByPos_Bsy	BOOL	FALSE
CAByPos_Act	BOOL	FALSE
CAByPos_Abt	BOOL	FALSE
CAByPos_Err	BOOL	FALSE
CAByPos_ErrID	WORD	0
CAByPos1	DMC_ControlAxisByPos	
Axis2	USINT	2
CAByPos1_Ex	BOOL	FALSE
CAByPos1_Ex_Vel	LREAL	1
CAByPos1_Ex_Acc	LREAL	1
CAByPos1_Ex_Dec	LREAL	1
CAByPos1_Ex_Jerk	LREAL	1
CAByPos1_InC	BOOL	FALSE
CAByPos1_Bsy	BOOL	FALSE
CAByPos1_Act	BOOL	FALSE
CAByPos1_Abt	BOOL	FALSE
CAByPos1_Err	BOOL	FALSE
CAByPos1_ErrID	WORD	0
NC	DMC_NC	
NC_EX	BOOL	FALSE
NC_Pau	BOOL	FALSE
NC_Stop	BOOL	FALSE
NC_Ver	LREAL	100
NC_Dep	UINT	1
NC_File	UINT	1
NC_Axes	UINT	1
NC_Mode	INT	0
NC_Res	LREAL	0
NC_Act	BOOL	FALSE
NC_Err	BOOL	FALSE
NC_ErrID	WORD	0
NC_Bys	BOOL	0
NC_Cur	UDINT	0
NC_Px	LREAL	0
NC_Py	LREAL	0
NC_Pz	LREAL	0
NC_Pa	LREAL	0
NC_Pb	LREAL	0
NC_Pc	LREAL	0
NC_Pp	LREAL	0
NC_Pq	LREAL	0

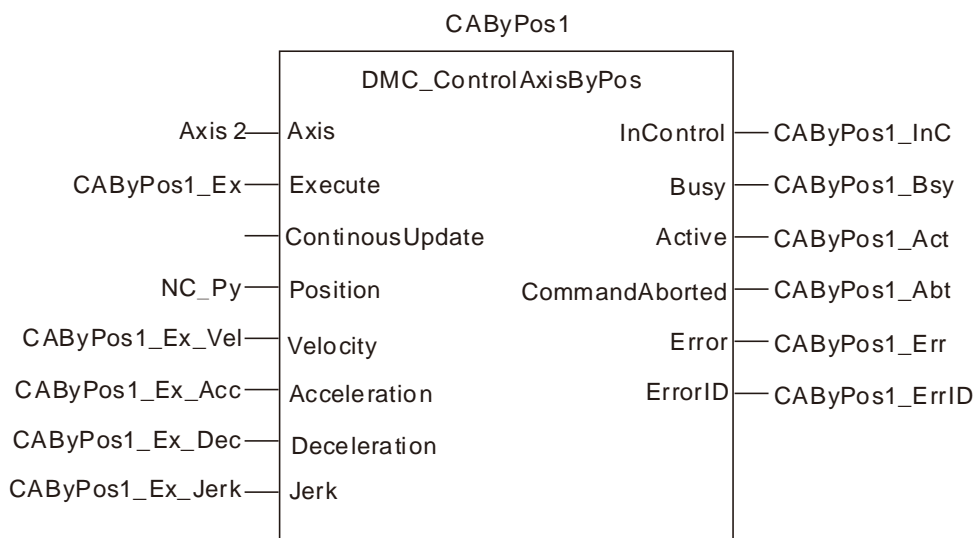
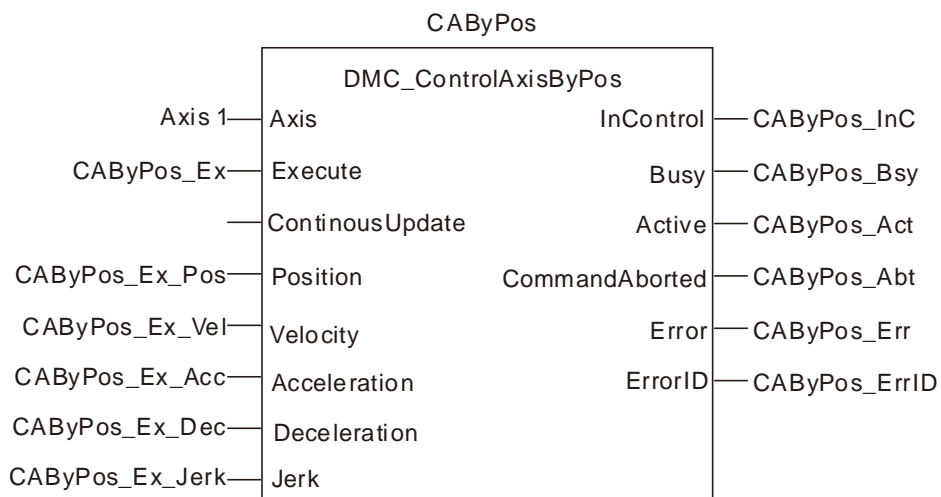
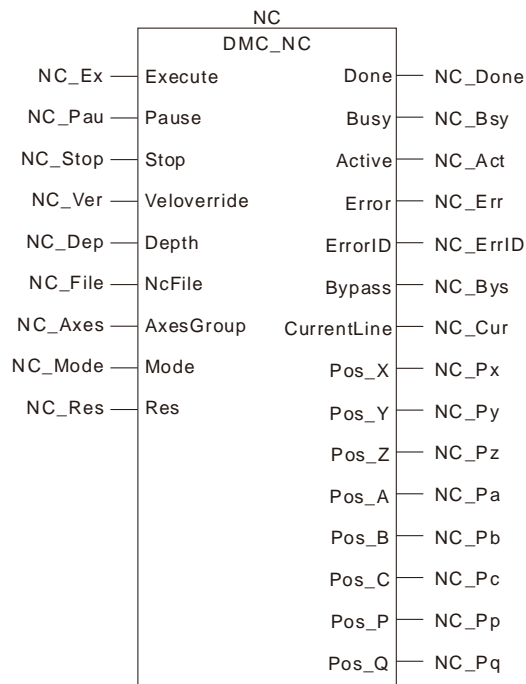

When CAByPos_Ex and CAByPos1_Ex are set to TRUE after axis 1 and axis 2 are power on, *Busy* and *Active* of CAByPos and CAByPos1 instructions change to TRUE.

After the NC_Ex variable changes to TRUE, NC_Bsy changes to TRUE, NC_Act changes to TRUE, NC_Cur displays the number of the row in which the CNC file is being parsed currently. NC_Px, NC_Py, NC_Pz, NC_Pa, NC_Pb, NC_Pc, NC_Pp and NC_Pq output the positions of axes respectively after the CNC file is parsed in the current cycle.

CAByPos controls X axis to move according to the value of NC_Px which is parsed out and CAByPos1 controls Y axis to move according to the value of NC_Py which is parsed out.

- After the program is executed, the Position/Time curve for the whole motion process is shown as below.

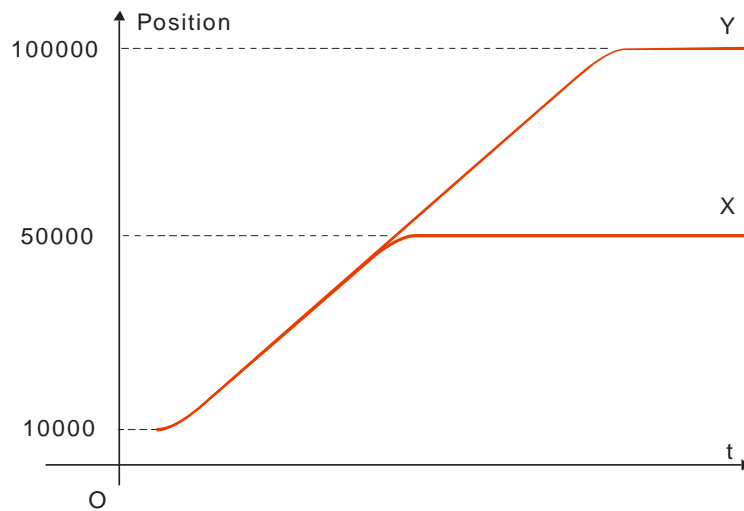

MEMO

Chapter 12 Troubleshooting

Table of Contents

12.1 Explanation of LED Indicators 12-2
12.2 Table of Error IDs in Motion Instructions 12-8
12.3 System Trouble Diagnosis through System Error Codes 12-19

This section mainly introduces the troubleshooting methods when any trouble occurs in DVP-15MC series controller.

12.1 Explanation of LED Indicators

● PWR LED

POWER LED indicates the state of the power supply for DVP-15MC series motion controller.

LED state	Explanation	How to deal with
Green light ON	Supply power is normal	No correction
LED OFF or blinking	Supply power is abnormal	Check if the supply power for DVP-15MC series motion controller is normal.

● RUN LED

RUN LED indicates the state of program execution in DVP-15MC series motion controller.

LED state	Explanation	How to deal with
Green light ON	DVP-15MC series motion controller is in RUN state.	No correction
LED OFF	DVP-15MC series motion controller is in STOP state.	Switch PLC to the RUN state according to demand

● ERR LED

ERR LED indicates the error state of DVP-15MC series motion controller.

LED state	Explanation	How to deal with
LED OFF	DVP-15MC series motion controller is in the state of normal work.	No correction
Red light blinking	Errors in the program or configuration.	Get the detailed error information through the error diagnosis function.
Red light ON	Mistakes in hardware	Contact local technicians.

■ ERR LED: Red light blinks. (1HZ)

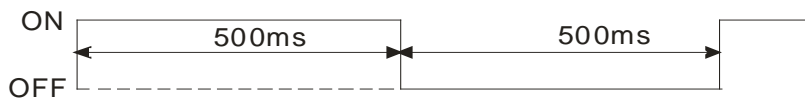

■ ERR LED: Red light blinks quickly. (10HZ)

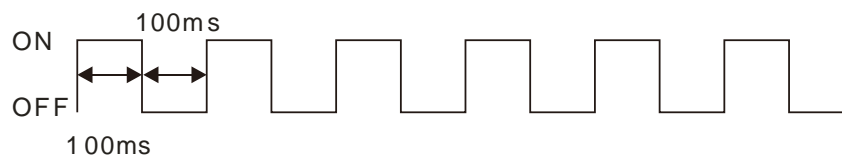

● SD LED

SD LED is used for displaying the state of the SD card in DVP-15MC series motion controller.

LED state	Explanation	How to deal with
LED OFF	1. No SD card is inserted to DVP-15MC series motion controller.	Insert the SD card or not according to the actual demand

LED state	Explanation	How to deal with
	2. An error occurs in reading and writing the document	
Green light blinks quickly.	The SD card in DVP-15MC series motion controller is exchanging data	No correction
Green light ON	No data exchange for the SD card in DVP-15MC series motion controller.	

● **CAN1 (CANopen) LED**

■ **RUN LED**

LED state	Explanation	How to deal with
Green light single flash	CAN1 (CANopen) communication port is in STOP state.	PC is downloading the network configuration data. Wait till downloading is completed.
Green light blinking	CAN1 (CANopen) communication port is in Preoperational state.	<ol style="list-style-type: none"> 1. Check if CANopen network bus cable connection is correct. 2. Check if the CANopen bus cable is Delta standard CANopen cable. 3. Check if the two ends of the CANopen bus have connected a terminal resistor respectively. 4. Check if the baud rate of the master is the same as that of other slaves. 5. Check if configured slaves have been actually connected to the network. 6. Check if some slave can not make the connection with the master. 7. Check if some slave is offline.
Green light ON	CAN1 (CANopen) communication port is in RUN state.	No correction

■ **RUN LED: Green light is in single flash and blinks as below.**

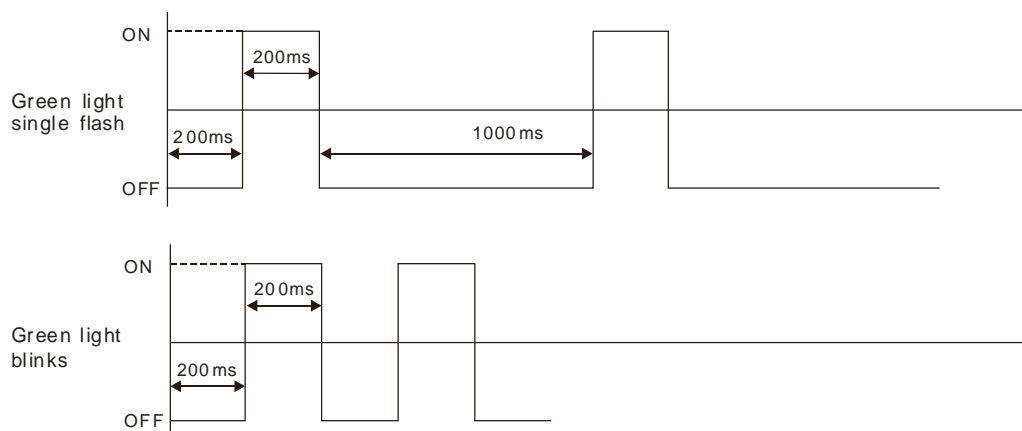

■ ERR LED

LED state	Explanation	How to deal with
LED OFF	PLC module is in the state of normal work.	No correction
Red light double flashes	Some slave is offline.	<ol style="list-style-type: none"> 1. Check if the CANopen bus cable is Delta standard cable. 2. Check if the two ends of CANopen bus have connected a terminal resistor respectively. 3. Check if configured slaves have been actually connected to the network. 4. Check if the interference around CANopen bus cable is too strong.
Red light single flash	The bus error is out of the alert level.	<ol style="list-style-type: none"> 1. Check if the CANopen bus cable connection is correct. 2. Check if the CANopen bus cable is Delta standard cable. 3. Check if the two ends of CANopen bus have connected a terminal resistor respectively. 4. Check if the baud rate of CANopen port is the same as that of other slaves. 5. Check if the interference around CANopen bus cable is too strong.
Red light ON	Bus-off	<ol style="list-style-type: none"> 1. Check if the bus cable wiring in CANopen network is correct. 2. The baud rates of DVP-15MC series motion controller and other stations are same.

■ ERR LED: Red light is in a single flash and double flashes as below.

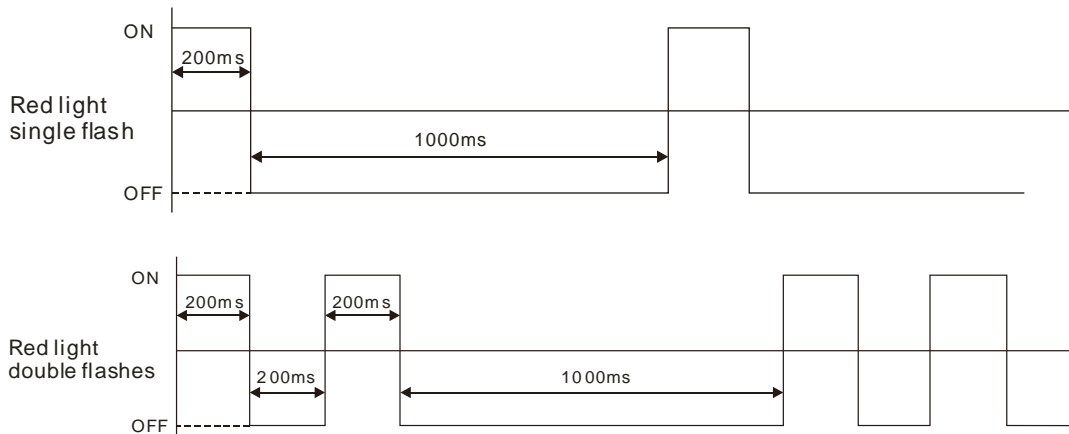

● CAN2 (Motion) LED

■ RUN LED

LED state	Explanation	How to deal with
LED OFF	No axis is configured for CAN2 (Motion) port in the software.	Configure the slave connected to Motion port to the master in the software.
Green light blinking	Not all of the axes configured for CAN2 (Motion) in the software have been online.	<ol style="list-style-type: none"> 1. Check if the bus cable connection in the Motion network is correct.

LED state	Explanation	How to deal with
		<ol style="list-style-type: none"> 2. Check if the Motion bus cable is Delta standard CANopen cable. 3. Check if the two ends of Motion bus have connected a terminal resistor respectively 4. Check if the baud rates of Motion port and slaves are same. 5. Check if the slaves configured in the software have actually been connected to the network. 6. Check if some slave can not make the connection with the master. 7. Check if some slave is offline.
Green light ON	All of the axes configured for CAN2 (Motion) in the software have been online.	No correction

■ RUN LED

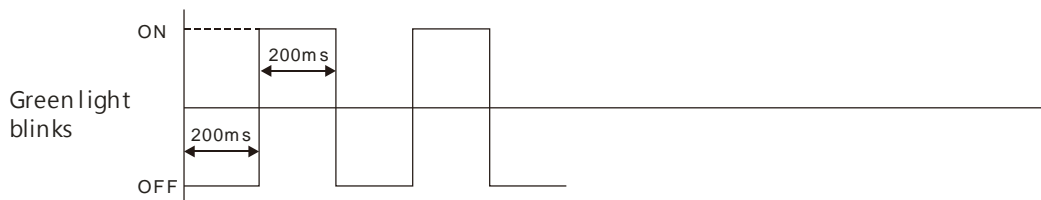

■ ERR LED

LED state	Explanation	How to deal with
LED OFF	PLC module is in the state of normal work.	No correction
Red light double flashes	Some slave is offline	<ol style="list-style-type: none"> 1. Check if the Motion bus cable is Delta standard CANopen cable. 2. Check if the two ends of Motion bus have connected a terminal resistor respectively. 3. Check if all slaves configured in the software have actually been connected to the network. 4. Check if the interference around CANopen bus cable is too strong.
Red light single flash	The bus error is out of the alert level.	<ol style="list-style-type: none"> 1. Check if the bus cable connection in the Motion network is correct.
Red light ON	Bus-off	<ol style="list-style-type: none"> 2. Check if the Motion bus cable is Delta standard CANopen cable. 3. Check if the two ends of Motion bus have connected a terminal resistor respectively. 4. Check if the baud rates of Motion port and slaves are same. 5. Check if the interference around Motion bus cable is too strong.

■ **ERR LED: Red light is in a single flash and double flashes as below.**

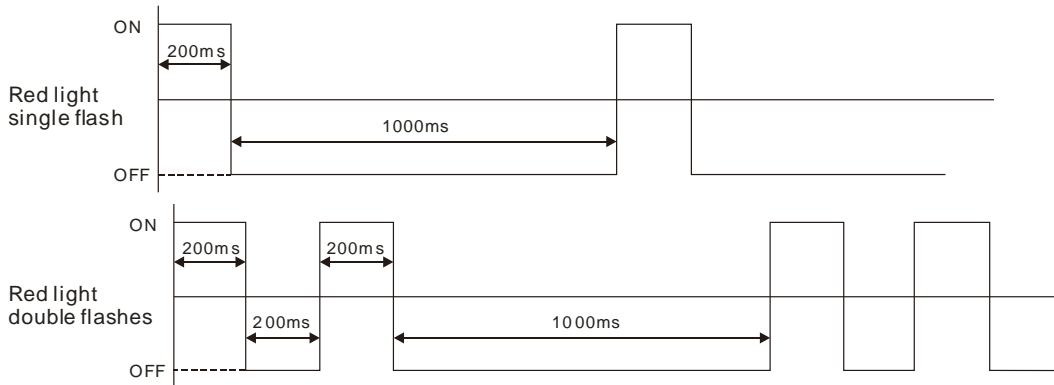

● **LAN1 LED**

LAN1 LED indicates the network state of the first Ethernet communication port of the left side of DVP-15MC series motion controller.

LED	State	Indication
Yellow light	Blinking	Data are being sent or received via the first Ethernet port of DVP-15MC series motion controller.
	OFF	The first Ethernet port of DVP-15MC series motion controller is not connected to the Ethernet network.

● **LAN2 LED**

LAN2 LED indicates the network state of the second Ethernet communication port of the left side of DVP-15MC series motion controller.

LED	State	Indication
Yellow light	ON	Data are being sent or received via the second Ethernet port of DVP-15MC series motion controller.
	OFF	The second Ethernet port of DVP-15MC series motion controller is not connected to the Ethernet network.

● **RS232 LED**

RS232 LED, the RS-232 communication indicator of DVP-15MC series motion controller indicates the communication state of RS-232 port of DVP-15MC series motion controller.

LED state	Indication
Yellow light blinking	There are response data via RS-232 port.
LED OFF	There are no response data via RS-232 port.

● **RS485 LED**

RS485 LED, the RS-485 communication indicator of DVP-15MC series motion controller indicates the communication state of RS-485 port of DVP-15MC series motion controller.

LED state	Indication
Yellow light blinking	There are response data via RS-485 port.
LED OFF	There are no response data via RS-485 port.

● **Input point LED**

There are 16 input point LED indicators for showing if DVP-15MC series motion controller's digital input points are ON or OFF.

LED state	Indication
Red light ON	Input point is ON.
LED OFF	Input point is OFF.

- **Output point LED**

There are 8 output point LED indicators for showing if DVP-15MC series motion controller's digital output points are ON or OFF.

LED state	Indication
Red light ON	Output point is ON.
LED OFF	Output point is OFF.

12.2 Table of Error IDs in Motion Instructions

When an error occurs in the motion instruction, the value of ErrorID can be seen as follows for analysis of the cause and troubleshooting.

ErrorID		Meaning	How to deal with
Hex	Decimal		
1001	4097	The axis No. exceeds the valid range.	Make sure that the value of the input variable, <i>Axis</i> is within the allowed range.
1002	4098	The acceleration exceeds the valid range.	Make sure that the value of the input variable, <i>Acceleration</i> is a positive number.
1003	4099	The deceleration exceeds the valid range.	Make sure that the value of the input variable, <i>Deceleration</i> is a positive number.
1004	4100	The change rate of the acceleration exceeds the valid range.	Make sure that the value of the input variable, <i>Jerk</i> is a positive number.
1005	4101	The velocity exceeds the valid range.	Make sure that the value of the input variable, <i>Velocity</i> is a nonzero value.
1006	4102	The position value exceeds the valid range.	Make sure that the value of the input variable, <i>Position</i> of MC_MoveAbsolute is not greater than the value of Modulo among axis parameters.
1007	4103	The direction value exceeds the valid range.	Modify the value of the input variable, <i>Direction</i> into that which can be set in the instruction.
1008	4104	The buffermode value exceeds the valid range.	Modify the value of the input variable, <i>BufferMode</i> into that which can be set in the instruction.
1009	4105	The input value for reference position type is wrong.	Modify the value of the input variable, <i>ReferenceType</i> into that which can be set in the instruction.
100A	4106	The timing for executing MC_SetPosition is improper.	Change the timing of executing MC_SetPosition. Do not execute MC_SetPosition while MC_Home or MC_Stop is being executed.
100B	4107	The number of e-cam table is incorrect.	Modify the value of the input variable, <i>CamTable</i> into that of CamId set in the software.
100C	4108	The axis No. of the master axis is incorrect.	Make sure that the value of the input variable, <i>Axis</i> is within the allowed range.
100D	4109	The input value of the engagement mode is wrong.	Modify the value of the input variable, <i>StartMode</i> into that which can be set in the instruction.
100E	4110	The value of the master scaling is incorrect.	Make sure that the value of the input variable, <i>MasterScaling</i> is a positive number.
100F	4111	The value of the slave scaling is incorrect.	Make sure that the value of the input variable, <i>SlaveScaling</i> is a nonzero value.
1010	4112	The chosen position source of the master axis is wrong.	Modify the value of the input variable, <i>MasterValueSource</i> into that which can be set for the instruction.
1011	4113	Conflict in the axis No. of the master and slave axes.	Modify the values of the input variables, <i>Master</i> and <i>Slave</i> into different values.
1012	4114	Wrong e-gear numerator value	Modify the value of the input variable, <i>Numerator</i> into a nonzero value.

ErrorID		Meaning	How to deal with
Hex	Decimal		
1013	4115	Wrong e-gear denominator value	Modify the value of the input variable, <i>Denominator</i> into a nonzero value.
1014	4116	The value of <i>VelFactor</i> is incorrect.	Modify the value of the input variable, <i>VelFactor</i> into that which can be set in the instruction.
1015	4117	SDO Timeout in CANopen network (or Motion network)	<ol style="list-style-type: none"> 1. Check if the slave specified in the instruction exists. 2. Check if the connection between the accessed slave and CANopen port or Motion port is normal. 3. Check if the baud rates of CANopen port or Motion port and the accessed slave are same.
1016	4118	The input parameter error of the SDO instruction	Check if the input parameter settings of the SDO instruction are reasonable. For example, see whether the accessed Index and Subindex exist or not and whether the value of <i>DataType</i> is legal or not.
1017	4119	Other faults in SDO in CANopen network (or Motion network).	Check if slaves are in normal work.
1018	4120	The value of <i>TriggerInput</i> of the position-capture instruction <i>DMC_TouchProbe</i> is wrong.	Modify the value of the input variable, <i>TriggerInput</i> . The value can be set within the range of 0~15 respectively representing I0~I7 and I10~I15.
1019	4121	The input point specified by <i>TriggerInput</i> of the instruction <i>DMC_TouchProbe</i> has been used in another <i>DMC_TouchProbe</i> .	Modify the value of <i>TriggerInput</i> of the instruction into one value which has not been used yet.
101A	4122	Windowonly of <i>DMC_TouchProbe</i> is abnormal.	Modify the values of <i>Firststops</i> and <i>Lastops</i> into those within the valid range.
101B	4123	Two <i>DMC_TouchProbe</i> instructions are performed for capturing the position of the same axis at the same time.	Prevent two <i>DMC_TouchProbe</i> instructions from capturing the position of the same axis at the same time.
101C	4124	The setting value of <i>Mode</i> of <i>DMC_TouchProbe</i> is incorrect.	Modify the value of the input variable, <i>Mode</i> into that which can be set in the instruction.
101D	4125	The axis specified by <i>DMC_TouchProbe</i> is not an encoder axis.	Modify the value of the input variable, <i>Axis</i> into the axis No. of the encoder axis which has been configured.
101E	4126	The value of <i>ActivationPosition</i> of <i>MC_CamIn</i> is incorrect.	Modify the value of the input variable, <i>ActivationPosition</i> into that which can be set in the instruction.
1020	4128	The used axis is not configured to the Motion network in the software.	Modify the value of the input variable, <i>Axis</i> into the axis No. which has been configured in the Motion network.
1021	4129	The radius of the rotary-cut axis is incorrect.	Modify the value of the input variable, <i>RotaryAxisRadius</i> . It should be greater than 0.
1022	4130	The radius of the feed axis is incorrect.	Modify the value of the input variable, <i>FeedAxisRadius</i> . It should be greater than 0.
1023	4131	The cutting length is incorrect.	Modify the value of the input variable, <i>CutLenth</i> of <i>APF_RotaryCut_Init</i> . It should

ErrorID		Meaning	How to deal with
Hex	Decimal		
			be greater than 0.
1024	4132	The value of SyncStartPos is incorrect.	Modify the value of the input variable, <i>SyncStartPos</i> of APF_RotaryCut_Init. It should be between 0 and the cutting length.
1025	4133	The value of SyncStopPos is incorrect.	Modify the value of the input variable, <i>SyncStopPos</i> of APF_RotaryCut_Init. It should be between 0 and the cutting length.
1026	4134	The settings of SyncStopPos and SyncStartPos are incorrect.	The value of the input variable, <i>SyncStopPos</i> should be less than that of <i>SyncStartPos</i> of the instruction.
1027	4135	The value of RotCutID is incorrect.	The value of the input variable, <i>RotCutID</i> should be in the range of 1~8.
1028	4136	The value of RotaryAxisKnifeNum is incorrect.	The value of the input variable, <i>RotaryAxisKnifeNum</i> should be in the range of 1~16.
1029	4137	The inner state of rotary cut is illegal.	Modify the parameter values for initializing rotary cut.
103A	4154	Rotary cut initializing fails.	Since APF_RotaryCut_Init has not been executed, please execute APF_RotaryCut_Init first and then execute APF_RotaryCut_In.
103B	4155	The axis is offline and the capture function can not be performed	Execute the capture instruction after the axis is connected normally.
103C	4156	The value of <i>MasterOffset</i> of MC_CamIn is greater than the master axis cam cycle range.	Modify the value of <i>MasterOffset</i> into that between the negative number and positive number of the master axis cam cycle range. (The master axis cam cycle range= Maximum master axis cam cycle- Mimimum master axis cam cycle)
103D	4157	The value of <i>SlaveOffset</i> of MC_CamIn is greater than the slave axis cam cycle range.	Modify the value of <i>SlaveOffset</i> into that between the negative number and positive number of the slave axis cam cycle range. (The slave axis cam cycle range= Maximum slave axis cam cycle- Minimum slave axis cam cycle)
103E	4158	The <i>Depth</i> value of the instruction is out of the range.	Modify the value of the input <i>Depth</i> in order not to exceed the range.
103F	4159	The <i>VelOverride</i> value range of the instruction is illegal.	Modify the value of the input <i>VelOverride</i> in order not to exceed the range.
1040	4160	The file code is illegal.	Modify the value of the input <i>NCFfile</i> into a proper code value.
1041	4161	DMC_SetTorque is executed when the axis is not in Standstill state.	Make sure that DMC_SetTorque is executed when the axis is in Standstill state.
1042	4162	The execution of MC_Reset fails.	1. Check if the axis specified by MC_Reset exists. 2. MC_Reset is executed after the servo alarm is cleared.
1043	4163	The execution of an instruction leads to the result that the axis position exceeds the range set in	Modify the instruction to make sure that the final position does not exceed the software limit range.

ErrorID		Meaning	How to deal with
Hex	Decimal		
		the software.	
1044	4164	The cam curve specified by MC_CamIn is not built in the software.	Check if the <i>CamTable</i> value of MC_CamIn can correspond to the cam curve built in the software.
1045	4165	Axis group ID error	Check if the value of <i>GroupID</i> is within the range of 1~8.
1046	4166	Mode input value error	The value of <i>Mode</i> for the instruction can only be set to 0
1047	4167	The number of the From/To instruction is wrong.	Check the value of <i>Station</i> and the number of the instruction are correct.
1048	4168	An error in the number of CR registers which are read and written by From/To.	Check if the value of <i>Num</i> is within the range of 1~64.
1049	4169	The variable is not set for an instruction input pin	Set an variable for the input pin.
104A	4170	No response transmitted to From/To instruction	Check if the connection between modules is proper and if the extension module works normally.
104B	4171	Empty CNC file	Check if the value of <i>NCFile</i> is correct and the corresponding CNC file is empty.
104C	4172	Path resolution error	Ensure that the G codes or axes group instructions settings for the path are correct.
104D	4173	The position capture instruction did not receive the capture signal within the window range and the capture failed.	Ensure that the window range is set properly.
104E	4174	G code identifying error	Ensure that G code file writing is proper.
104F	4175	Incorrect pre-read G code format	Ensure that G code file writing is proper.
1050	4176	G-code pre-reading error	Ensure that G code file writing is proper.
1051	4177	Path writing error	Ensure that path writing is proper.
1052	4178	The setting for Position of the axis drive specified in MC_Home instruction failed. Perhaps the drive does not support the parameter.	Check if the drive supports the parameter <i>Position</i> .
1053	4179	MC_Home instruction does not support the encoder axis which takes data sources as the encoder mode and SSI absolute encoder axis.	Modify the axis type into other axis type.
1054	4180	Too many levels of G26 nesting in G codes	Check if the number of levels of G26 nesting exceeds 16.
2001	8193	The axis is disabled by means of MC_Power instruction when it is not in Standstill state.	Make the axis disabled by using MC_Power instruction when the axis is in Standstill state.
2002	8194	The instruction cannot be executed due to the limitation of the motion direction.	Set <i>EnablePositive</i> and <i>EnableNegative</i> of MC_Power to TRUE to cancel the limitation of the motion direction of the axis.

ErrorID		Meaning	How to deal with
Hex	Decimal		
2004	8196	MC_HaltSuperimposed cannot be performed when MC_MoveSuperimposed is not executed yet.	Modify the sequence of execution of MC_HaltSuperimposed. The execution of MC_HaltSuperimposed should be conducted in the process of performing MC_MoveSuperimposed.
2100	8448	The state machine limits that the function cannot be performed.	Modify the timing for execution of the instruction. Refer to the state machine in section 10.4 for the execution of motion instructions.
2101	8449	The buffer register is full.	The <i>BufferMode</i> of a motion control instruction only supports one switch for changing the time to execute current instruction and avoiding the circumstance that another instruction is also waiting to execute (<i>BufferMode</i> is not 0) while one instruction is waiting to execute (<i>BufferMode</i> is not 0).
2102	8450	Buffer function cannot be performed in the instruction.	The instruction cannot be operated in <i>BufferMode</i> .
3001	12289	An error in axis type setting	Modify the axis type on the axis configuration window.
3002	12290	Servo alarm	Have the control over the servo after clearing the servo alarm.
3003	12291	Servo Timeout	Check if the connection between the controller and servo is OK.
3004	12292	The command position exceeds the limit position set in the software.	Check if the set software limit position is proper or disable the software limit position.
3005	12293	The process from RUN to STOP occurs in the controller (during the execution of a motion instruction)	Clear the error with the MC_Reset instruction and then execute other motion instruction.
600D	24589	Connection error	Check if the communication cable is proper.
6200	25088	TCP remote IP error	Check if the TCP remote IP address format is correct.
6201	25089	TCP remote port error	Check if the TCP remote port setting is out of the valid range.
6203	25091	TCP data-sending register address error	Check if the data-sending register address is within the valid range.
6206	25094	TCP data-receiving register address error	Check if the data-receiving register address is within the valid range.
6208	25096	The data that TCP master actually receives exceed the set length.	Modify the specified length of received data.
6209	25097	UDP remote IP address error	Check if the UDP remote IP address format is correct.
620A	25098	UDP communication port error	Modify UDP communication port.
620C	25100	UDP sending register address error	Check if the data-sending register address is within the valid range.
620F	25103	UDP receiving register address error	Check if the data-receiving register address is within the valid range.
6210	25104	The UDP data actually received	Modify the specified length of data to be

ErrorID		Meaning	How to deal with
Hex	Decimal		
		exceed the set length.	received.
6212	25106	Ethernet connection timeout	Modify the timeout time or check if the remote device is connected normally.
6213	25107	The data that TCP slave actually receives exceed the set length.	Modify the specified length of sent data.
6214	25108	The link is disabled due to a connection exception.	Make sure the remote device works.
6215	25109	The connection fails or is not enabled yet.	Check if the instruction operation sequence is correct.
6220	25120	Timeout	Modify timeout time or ensure the remote device is connected normally.
6300	25344	The number of connections exceeds the limit.	Check if the connection number is within the allowed range.
8000	32768	The instruction can be used for the diagnosis only when the controller works as CANopen master.	Modify the local controller as CANopen master before using the instruction.
8800	34816	The priority number of the task is greater than 31.	Set the priority number of the task to a value less than 31.
8801	34817	The watchdog function for the task has not been enabled yet.	Enable the watchdog function before the instruction execution.
8808	34824	The master has not configured the slave for diagnosis.	Configure the slave before the diagnosis.
8810	34832	Diagnosis type error	Modify diagnosis type
8818	34840	The axis to be diagnosed has not been configured.	Configure the axis before the diagnosis.
8820	34848	Diagnosis type error	Modify diagnosis type
9000	36864	Ethernet Link number exceeds the range of 1~16.	Modify Ethernet link number as 1~16
9001	36865	The written-data length configured for Ethernet link exceeds the maximum.	Modify the written-data length configured for Ethernet link within the allowed range.
9002	36866	The read-data length configured for Ethernet link exceeds the maximum.	Modify the read-data length configured for Ethernet link within the allowed range.
9003	36867	Ethernet physical connection error	Check if the network hardware connection is normal, e.g. the network cable connection.
9004	36868	Socket number exceeds the valid range	Modify Socket number as 1~4.
9005	36869	The length of sent data configured for Socket function exceeds the allowed maximum value.	Modify the length of sent data configured for Socket function as a value within 0~200.
9006	36870	The length of received data configured for Socket function exceeds the allowed maximum value.	Modify the length of received data configured for Socket function as 0~200.
9007	36871	Communication timeout time setting in Ethernet link configuration is improper.	Modify the timeout time as a value greater than 0.
9008	36872	The lengths of sent data and received data configured for the	Modify either of the lengths of sent data and received data configured for the Socket

ErrorID		Meaning	How to deal with
Hex	Decimal		
		Socket function are both 0.	function as a value which is not 0.
9010	36880	RS485 PLC Link number exceeds the range of 1-24.	Modify PLC Link number as a value within the range of 1-24.
9011	36881	The written-data length configured for RS485 PLC link exceeds the allowed maximum value.	Modify written data length configured for RS485 PLC link as a value which is within the allowed range.
9012	36882	The read data length configured for RS485 PLC link exceeds the allowed maximum value.	Modify read data length configured for RS485 PLC link as a value within the allowed range.
9013	36883	The length of sent data configured for RS485 free protocol function exceeds the allowed maximum value.	Modify the length of sent data configured for RS485 free protocol function as a value within the allowed range.
9014	36884	The length of received data configured for RS485 free protocol function exceeds the allowed maximum value.	Modify the length of received data configured for RS485 free protocol function as a value within the allowed range.
9015	36885	The number of the RS232 PLC Link exceeds the range of 1~24.	Modify the number of the RS232 PLC Link as a value within the range of 1-24.
9016	36886	The written-data length configured for RS232 PLC link exceeds the allowed maximum value.	Modify the written-data length configured for RS232 PLC link as a value within the allowed range.
9017	36887	The read-data length configured for RS232 PLC link exceeds the allowed maximum value.	Modify the read-data length configured for RS232 PLC link as a value within the allowed range.
9018	36888	The length of sent data configured for RS232 free protocol function exceeds the allowed maximum value.	Modify the length of sent data configured for RS232 free protocol function as a value within the allowed range.
9019	36889	The length of received data configured for RS232 free protocol function exceeds the allowed maximum value.	Modify the length of received data configured for RS232 free protocol function as a value within the allowed range.
901A	36890	Communication timeout time setting in RS485/RS232 PLC link configuration is improper.	Modify the timeout time as a value greater than 0.
901B	36891	The lengths of read data and written data configured for the Ethernet/RS485/RS232 link are both 0.	Modify either of the lengths of read data and written data configured as a value which is not 0.
901C	36892	The lengths of sent data and received data configured for the RS485/RS232 free protocol function are both 0.	Modify either of the lengths of sent data and received data configured as a value which is not 0.
9020	36896	The local buffer of word type for data writing has no enough space to meet the specified length of data. (Valid range: %MW0~%MW32767)	Modify the start address of the local buffer to make it have enough space to meet the specified data length.
9021	36897	The start address of the local buffer of word type for data	Modify the start address of the local buffer within the allowed word register area.

ErrorID		Meaning	How to deal with
Hex	Decimal		
		writing is out of the allowed word register area. (Valid range: %MW0~%MW32767)	
9022	36898	The start address of the local buffer of word type for data writing is within the allowed word register area but can not meet the alignment of word register addresses. (Valid range: %MW0~%MW32767)	Modify the start address of the local buffer or offset length.
9023	36899	The local buffer of word type for the data reading has no enough space to meet the specified length of data. (Valid range: %MW0~%MW32767)	Modify the start address of the local buffer to make it have enough space to meet the specified data length.
9024	36900	The start address of the local buffer of word type for data writing is out of the allowed word register area. (Valid range: %MW0~%MW32767)	Modify the start address of the local buffer within the allowed word register area.
9025	36901	The start address of the local buffer of word type for data reading is within the allowed word register area but can not meet the alignment of word register addresses. (Valid range: %MW0~%MW32767)	Modify the start address of the local buffer or offset length.
9026	36902	The local buffer of bit type for data writing has no enough space to meet the specified length of data. (Range: %QX0.0~%QX127.7,%MX0.0~%MX65535.7)	Modify the start address of the local buffer to make it have enough space to meet the specified data length.
9027	36903	The start address of the local buffer of bit type for data writing is out of the allowed area. (Range: %QX0.0~%QX127.7,%MX0.0~%MX65535.7)	Modify the start address of the local buffer within the allowed area.
9028	36904	The local buffer of bit type for data reading has no enough space to meet the specified length of data. (%QX0.0~%QX127.7,%MX0.0~%MX65535.7)	Modify the start address of the local buffer to make it have enough space to meet the specified data length.
9029	36905	The start address of the local buffer of bit type for data reading	Modify the start address of the local buffer within the allowed area.

ErrorID		Meaning	How to deal with
Hex	Decimal		
		is out of the allowed area. (%QX0.0~%QX127.7,%MX0.0~%MX65535.7)	
9030	36912	Object type error	Modify the value of the input parameter ObjType.
9031	36913	The specified function code for data reading exceeds the allowed range.	Specify a new function code which is within the allowed range.
9040	36928	The local buffer for data sending has no enough space to meet the specified length of data. (%MW0~%MW32767)	Modify the start address of the local buffer or specified data length.
9042	36930	The start address of the local buffer for data sending is out of the allowed word register area. (Valid range: %MW0~%MW32767)	Modify the start address of the local buffer.
9043	36931	The local buffer specified for data receiving has no enough space to meet the specified length of data. (%MW0~%MW32767)	Modify the start address of the local buffer or specified data length.
9045	36933	The start address of the local buffer specified for data receiving is out of the allowed word register area. (Valid range: %MW0~%MW32767)	Modify the start address of the local buffer.
9100	37120	Socket instruction parameter value exceeds the allowed range.	Modify the Socket instruction parameter values within the allowed range.
9101	37121	Ethernet physical connection is disconnected.	Check if the network cable connection is proper.
9102	37122	TCP remote IP address error	Modify the setting for the remote IP address.
9103	37123	TCP port error	Modify the remote port setting.
9105	37125	An error occurs in the register addresses for TCP data sending.	Modify register address for sending TCP data.
9106	37126	TCP/UDP data receiving is in process.	The last data receiving has not been completed and thus the new receiving can not be triggered.
9107	37127	TCP receiving register address error	Modify the register address for receiving TCP data.
9108	37128	The length of received data exceeds the set length in TCP server mode.	Set the length of received data to the length which is greater than or equal to the number of bytes of the first received data.
9109	37129	The length of received data exceeds the set length in UDP transmission.	Set the length of received data to the length which is greater than or equal to the number of bytes of the first piece of received data.
910A	37130	UDP remote IP address error	Modify the remote IP address setting.
910B	37131	UDP port error	Local port and remote port can not be 0 at the same time.
910C	37132	An error occurs in the register addresses for sent UDP data.	Modify the register addresses for sent data.
910D	37133	An error occurs in the register addresses for received UDP data.	Modify the register addresses for storing the received data.

ErrorID		Meaning	How to deal with
Hex	Decimal		
910E	37134	TCP connection timeout	Check if the Socket configuration is proper or the remote device works normally.
910F	37135	The length of received data exceeds the set length in TCP client mode.	Set the length of received data to the length which is greater than or equal to the number of bytes of the first piece of received data.
9110	37136	TCP link is declined by the remote device.	Check if the remote device is normal or retry the link to the remote device.
9111	37137	TCP/UDP link has not been enabled.	Make sure that the link has been enabled.
9112	37138	TCP/UDP link has been triggered.	The link is being built and thus the link building can not be re-triggered.
9113	37139	TCP/UDP data sending has been triggered.	The last data sending has not been completed and thus the sending can not be re-triggered.
9114	37140	TCP/UDP link has been built.	The link has been built and thus the repeated trigger can not build a link.
9115	37141	TCP/UDP link is being disabled.	The link is being disabled and thus the link disabling can not be re-triggered.
9116	37142	TCP/UDP link is not disabled.	The configuration of Socket parameters can be conducted only when the link is disabled.
9117	37143	The parameter value for the length of sent TCP/UDP data exceeds the limit.	Modify the length of sent data within the allowed range.
9118	37144	The parameter value for the length of received TCP/UDP data exceeds the limit.	Modify the length of received data within the allowed range.
A000	40960	Cam point number error	Modify the cam table number.
A001	40961	Tappet point number error	Modify tappet point number.
A008	40968	M code number error	Modify M code number.
A010	40976	Axes group state machine error	Modify the timing for the instruction execution.
A011	40977	The axes group number exceeds the allowed range.	Modify the axes group number.
A012	40978	The value of the input parameter <i>TransitionMode</i> is incorrect.	Modify the input value.
A013	40979	The value of the input parameter <i>TransitionParameter</i> is incorrect.	Modify the input value.
A014	40980	The setting value of <i>BufferMode</i> does not match that of <i>TransitionMode</i> .	Modify the input value.
A015	40981	The value of <i>CircMode</i> is incorrect.	Modify the input value.
A016	40982	The value of <i>PathChoice</i> is incorrect.	Modify the input value.
A800	43008	The mechanical gear ratio can not be 0 or a negative number.	Modify the mechanical gear ratio.
A801	43009	The <i>UnitsPerRotation</i> value can not be 0 or a negative number.	Modify the <i>UnitsPerRotation</i> value.
A802	43010	Axis type error	Modify the axis type.
A803	43011	The value of the modulo can not be a non-positive number.	Modify the value of the modulo.
A808	43016	<i>Ex_Move</i> is executed again when the instruction execution has not been completed yet.	Modify the timing of the instruction execution.

ErrorID		Meaning	How to deal with
Hex	Decimal		
A809	43017	<i>Ex_Move</i> need be executed first before <i>Ex_Stop</i> is executed.	Modify the timing of the instruction execution.
A80A	43018	The <i>RoundPhase</i> value should be greater than 0.	Modify the <i>RoundPhase</i> value as a value which is greater than 0.
A80B	43019	The <i>StopPhase</i> value should be greater than 0 and less than the <i>RoundPhase</i> value.	Modify the <i>StopPhase</i> value as a value which is greater than 0 and less than the <i>RoundPhase</i> value.
A810	43024	The <i>TorqueRamp</i> value is 0 or a negative number.	Modify the <i>TorqueRamp</i> value.
A818	43032	The <i>Lag</i> value is a negative number.	Modify the <i>Lag</i> value as a non-negative number.
A819	43033	The <i>HoldTime</i> value is a negative number.	Modify the <i>HoldTime</i> value as a non-negative number.
A820	43040	The tappet point count reaches the maximum value.	Make sure that the tappet point count does not exceed the maximum value.
A821	43041	The <i>MasterPos</i> value exceeds the allowable range.	Be sure that the master position of the tappet point is within the range for the master axis set in the software.
A830	43056	The identity number in the axes group has been used.	Modify the identity number.
A831	43057	The axis has been configured as an axis in the current axes group.	Change the axis number.
A838	43064	The operation state of the axes group is interrupted.	Modify the timing for the instruction execution.
A839	43065	When the instruction is executed, <i>Pause</i> and <i>Stop</i> must be FALSE.	Modify the timing for the instruction execution.
A83A	43066	No axes allocated in the axes group.	Modify the timing for the instruction execution.
A83B	43067	Axes in the axes group are not in Standstill state.	Modify the timing for the instruction execution.

12.3 System Trouble Diagnosis through System Error Codes

When the ERR indicator of DVP-15MC series motion controller blinks or is always ON, users can get to know the cause of an error and shoot the trouble through selecting menu Device > Diagnosis Information... in the CANopen Builder software of version 6.0 or above.

System error code		Explanation	Correction
Hexadecimal	Decimal		
1000	4096	Internal RAM detection failed	Contact local technicians if the error still exists after repower on.
1001	4097	Internal Flash detection failed	
1002	4098	The extension port detection failed	
1003	4099	Internal voltage is abnormal (LV)	Adjust input voltage to 24V at the power port.
1004	4100	Flash initializing failed	Contact local technicians if the error still exists after repower on.
1005	4101	Flash ID detection failed.	
1007	4103	The access to flash failed in the Ethernet area.	Contact local technicians if the problem still exists after re-downloading the program and restoring the setting to the factory setting.
1008	4104	The access to flash failed in the extension area.	
1009	4105	The access to flash failed in the program area.	
100A	4106	The access to flash failed in the motion area.	
100B	4107	The access to flash failed in the Task area.	
100C	4108	The access to flash failed in the CANopen communication.	
100D	4109	The access to flash failed in the hardware configuration.	
100E	4110	The access to flash failed in the CAM area.	
100F	4111	The access to flash (the flash management table) failed.	
1010	4112	The access to flash (sheet 1 in the flash management table) failed.	
1011	4113	The access to flash (sheet 2 in the flash management table) fails.	
1012	4114	The reading of flash failed.	
1013	4115	The writing in flash failed.	
1014	4116	The erasing of the content in flash failed.	
1015	4117	CNC file ID is out of the allowed range	Check if the CNC file ID is larger than 64. Update the software and redownload the program if the error still exists after redownloading the program.
1016	4118	The size of CNC file exceeds the range	CNC file is too large in size. Diminish the size and redownload the program.
1017	4119	The position of incremental encoder 1 changes dramatically in short time.	Check if the input of the encoder is too fast or enlarge the resolution of the encoder.
1018	4120	The position of incremental encoder 2 changes dramatically in short time.	Check if the input of the encoder is too fast or enlarge the resolution of the encoder.
1019	4121	System stack is used up.	There are too many intermediate variables in the program. Modify the program.

System error code		Explanation	Correction
Hexadecimal	Decimal		
101A	4122	The Retain file is too large.	There are too many Retain variables. Decrease the number of Retain variables and then redownload the program.
101B	4123	The access to Retain file failed.	Redownload the program after restoring the system to the factory setting.
101C	4124	EIP configuration data upload failed.	Contact local technicians if the problem still exists after re-downloading the program.
101D	4125	Cam table reading failed.	Contact local technicians if the problem still exists after re-downloading the program.
1020	4128	Illegal configuration file type	Contact local technicians if the problem still exists after re-downloading the program.
1021	4129	File storage failure	Contact local technicians if the problem still exists after re-downloading the program.
1022	4130	File reading failed	Contact local technicians if the problem still exists after re-downloading the program.
1023	4131	File check failure	Contact local technicians if the problem still exists after re-downloading the program.
1024	4132	File size exceeds allowed range.	Contact local technicians if the problem still exists after re-downloading the program.
1025	4133	Program file reading failed.	Contact local technicians if the problem still exists after re-downloading the program.
1026	4134	CANopen configuration file reading failed	Contact local technicians if the problem still exists after re-downloading the program.
1027	4135	Motion configuration file reading failed	Contact local technicians if the problem still exists after re-downloading the program.
1028	4136	System configuration file reading failed	Contact local technicians if the problem still exists after re-downloading the program.
1029	4137	Task configuration file reading failed	Contact local technicians if the problem still exists after re-downloading the program.
102A	4138	Extension configuration file reading failed	Contact local technicians if the problem still exists after re-downloading the program.
102B	4139	Cam file reading failed.	Contact local technicians if the problem still exists after re-downloading the program.
102C	4140	RETAIN file reading failed.	Contact local technicians if the problem still exists after re-downloading the program.
102D	4141	ID file reading failed.	Contact local technicians if the problem still exists after re-downloading the program.
102E	4142	Encrypted file reading failed.	Contact local technicians if the problem still exists after re-downloading the program.
102F	4143	CNC file reading failed.	Contact local technicians if the problem still exists after re-downloading the program.
1030	4144	Hardware does not match.	Contact local technicians.
1031	4145	Position parser processing fault	Contact local technicians.
1401	5121	The initializing of Ethernet LAN1 failed.	Contact local technicians if the error still exists after repower on.
1402	5122	The Ethernet LAN1 buffer overflows	
1403	5123	The data sending failed through the Ethernet LAN1.	
1404	5124	Sending the buffer memory distribution through Ethernet failed.	
1405	5125	The IP address of other device is the same as that of the PLC on the Ethernet network.	Ensure that no identical IP addresses exist on the network by changing the IP address of other device or the controller.
1601	5633	The Ethernet LAN2 initializing failed.	Contact local technicians if the error still exists after repower on.
1602	5634	The Ethernet LAN2 buffer overflows.	

System error code		Explanation	Correction
Hexadecimal	Decimal		
1603	5635	Full buffer area for USB communication	Contact local technicians if the problem still exists after re-downloading the program.
3000	12288	The number of inputs or the number of outputs is greater than the limit 32.	Reset the number of input and output variables in the self-defined POU and make sure the number of input or output variables does not exceed 32.
3001	12289	The capacity for one POU is more than 65535 bytes.	Change the capacity of variables in a POU to reduce the variable occupation in the memory.
3002	12290	The number of POUs is more than 1000.	Reduce the number of POUs called by the task and re-download the program.
3003	12291	The POU type is illegal.	Update the software if the error still exists after re-compiling and re-downloading the program and repowering the product.
3004	12292	The types of parameters in the program are illegal.	
3005	12293	Variable's offset address error in the program	
3006	12294	The data types of parameters are illegal in the program.	
3007	12295	The jump range in a program is illegal.	
3008	12296	Program memory allocation alignment is incorrect.	
3009	12297	Virtual axis encoder memory alignment is incorrect.	
300A	12298	The Bit accessed exceeds the range. (Only Bit0~Bit7 can be accessed.)	
300B	12299	It is detected that data types are illegal in the program.	
300C	12300	The length of data type String is too large.	
300D	12301	Illegal addressing method for variables	Update the software if the error still exists after re-compiling and re-downloading the program and repowering the product.
300E	12302	Improper priority setting of the task	Set a proper task priority and cycle time for the task
300F	12303	Exception occurs during accessing the controller's memory	Check whether any index is out of bounds of the array in the program. The pointer is used by not assigning it a value or is used by assigning it an incorrect value. Contact local technicians if the problem still exists after re-downloading the program.
3020	12320	The checksum of the downloaded Motion configuration is illegal.	Update the software if the error still exists after re-compiling and re-downloading the program and repowering the product.
3021	12321	The checksum of the downloaded extension configuration is illegal.	
3022	12322	The checksum of the downloaded program is illegal.	
3023	12323	The checksum of the downloaded task data is illegal.	
3024	12324	The checksum of the downloaded CANopen data is illegal.	
3025	12325	The checksum of the downloaded hardware configuration is illegal.	

System error code		Explanation	Correction
Hexadecimal	Decimal		
3026	12326	Watchdog timeout	Check if the program is correct or there is a loop of which the program execution can not get out when the program execution timeout occurs.
3027	12327	Calling the axis state machine failed.	Contact local technicians if the error still exists after re-downloading the program and restoring to the factory setting.
3028	12328	CNC list analysis error	Check if the CNC file is correct and re-download the program.
3029	12329	CNC file analysis error	Check if the CNC file is correct and re-download the program.
302A	12330	Cam file parsing failed.	Check if the cam file is correct. Contact local technicians if the problem still exists after re-downloading the program.
3031	12337	Source code file parsing failed.	Check if the source code file is correct. Contact local technicians if the problem still exists after re-downloading the program.
3050	12368	The actual time for executing the priority 0 task exceeds the set watchdog timeout time.	Contact local distributors
3051	12369	The actual time for executing the priority 1 task exceeds the set watchdog timeout time.	<ol style="list-style-type: none"> 1. Reset the watchdog time to a larger value for the task. 2. Check whether there is any infinite loop in the program which the task calls. 3. Redownload it after modifying the program.
3052	12370	The actual time for executing the priority2 task exceeds the set watchdog timeout time.	<ol style="list-style-type: none"> 1. Reset the watchdog time to a larger value for the task. 2. Check whether there is any infinite loop in the program which the task calls. 3. Redownload it after modifying the program.
3053	12371	The actual time for executing the priority 3 task exceeds the set watchdog timeout time.	<ol style="list-style-type: none"> 1. Reset the watchdog time to a larger value for the task. 2. Check whether there is any infinite loop in the program which the task calls. 3. Redownload it after modifying the program.
3054	12372	The actual time for executing the priority 4 task exceeds the set watchdog timeout time.	<ol style="list-style-type: none"> 1. Reset the watchdog time to a larger value for the task. 2. Check whether there is any infinite loop in the program which the task calls. 3. Redownload it after modifying the program.
3055	12373	The actual time for executing the priority 5 task exceeds the set watchdog timeout time.	<ol style="list-style-type: none"> 1. Reset the watchdog time to a larger value for the task. 2. Check whether there is any infinite loop in the program which the task calls. 3. Redownload it after modifying the program.
3056	12374	The actual time for executing the priority 6 task exceeds the set watchdog timeout time.	<ol style="list-style-type: none"> 1. Reset the watchdog time to a larger value for the task. 2. Check whether there is any infinite loop in the program which the task calls.

System error code		Explanation	Correction
Hexadecimal	Decimal		
			3. Revise the program or re-download the revised program.
3057	12375	The actual time for executing the priority 7 task exceeds the set watchdog timeout time.	<ol style="list-style-type: none"> 1. Reset the watchdog time to a larger value for the task. 2. Check whether there is any infinite loop in the program which the task calls. 3. Revise the program or re-download the revised program.
3058	12376	The actual time for executing the priority 8 task exceeds the set watchdog timeout time.	<ol style="list-style-type: none"> 1. Reset the watchdog time to a larger value for the task. 2. Check whether there is any infinite loop in the program which the task calls. 3. Redownload it after modifying the program.
3059	12377	The actual time for executing the priority 9 task exceeds the set watchdog timeout time.	<ol style="list-style-type: none"> 1. Reset the watchdog time to a larger value for the task. 2. Check whether there is any infinite loop in the program which the task calls. 3. Redownload it after modifying the program.
305A	12378	The actual time for executing the priority 10 task exceeds the set watchdog timeout time.	<ol style="list-style-type: none"> 1. Reset the watchdog time to a larger value for the task. 2. Check whether there is any infinite loop in the program which the task calls. 3. Redownload it after modifying the program.
305B	12379	The actual time for executing the priority 11 task exceeds the set watchdog timeout time.	<ol style="list-style-type: none"> 1. Reset the watchdog time to a larger value for the task. 2. Check whether there is any infinite loop in the program which the task calls. 3. Redownload it after modifying the program.
305C	12380	The actual time for executing the priority 12 task exceeds the set watchdog timeout time.	<ol style="list-style-type: none"> 1. Reset the watchdog time to a larger value for the task. 2. Check whether there is any infinite loop in the program which the task calls. 3. Redownload it after modifying the program.
305D	12381	The actual time for executing the priority 13 task exceeds the set watchdog timeout time.	<ol style="list-style-type: none"> 1. Reset the watchdog time to a larger value for the task. 2. Check whether there is any infinite loop in the program which the task calls. 3. Redownload it after modifying the program.
305E	12382	The actual time for executing the priority 14 task exceeds the set watchdog timeout time.	<ol style="list-style-type: none"> 1. Reset the watchdog time to a larger value for the task. 2. Check whether there is any infinite loop in the program which the task calls. 3. Redownload it after modifying the program.
305F	12383	The actual time for executing the priority 15 task exceeds the set watchdog timeout time.	<ol style="list-style-type: none"> 1. Reset the watchdog time to a larger value for the task.

System error code		Explanation	Correction
Hexadecimal	Decimal		
			<ol style="list-style-type: none"> 2. Check whether there is any infinite loop in the program which the task calls. 3. Redownload it after modifying the program.
3060	12384	The actual time for executing the priority 16 task exceeds the set watchdog timeout time.	<ol style="list-style-type: none"> 1. Reset the watchdog time to a larger value for the task. 2. Check whether there is any infinite loop in the program which the task calls. 3. Redownload it after modifying the program.
3061	12385	The actual time for executing the priority 17 task exceeds the set watchdog timeout time.	<ol style="list-style-type: none"> 1. Reset the watchdog time to a larger value for the task. 2. Check whether there is any infinite loop in the program which the task calls. 3. Redownload it after modifying the program.
3062	12386	The actual time for executing the priority 18 task exceeds the set watchdog timeout time.	<ol style="list-style-type: none"> 1. Reset the watchdog time to a larger value for the task. 2. Check whether there is any infinite loop in the program which the task calls. 3. Redownload it after modifying the program.
3063	12387	The actual time for executing the priority 19 task exceeds the set watchdog timeout time.	<ol style="list-style-type: none"> 1. Reset the watchdog time to a larger value for the task. 2. Check whether there is any infinite loop in the program which the task calls. 3. Redownload it after modifying the program.
3064	12388	The actual time for executing the priority 20 task exceeds the set watchdog timeout time.	<ol style="list-style-type: none"> 1. Reset the watchdog time to a larger value for the task. 2. Check whether there is any infinite loop in the program which the task calls. 3. Redownload it after modifying the program.
3065	12389	The actual time for executing the priority 21 task exceeds the set watchdog timeout time.	<ol style="list-style-type: none"> 1. Reset the watchdog time to a larger value for the task. 2. Check whether there is any infinite loop in the program which the task calls. 3. Redownload it after modifying the program.
3066	12390	The actual time for executing the priority 22 task exceeds the set watchdog timeout time.	<ol style="list-style-type: none"> 1. Reset the watchdog time to a larger value for the task. 2. Check whether there is any infinite loop in the program which the task calls. 3. Redownload it after modifying the program.
3067	12391	The actual time for executing the priority 23 task exceeds the set watchdog timeout time.	<ol style="list-style-type: none"> 1. Reset the watchdog time to a larger value for the task. 2. Check whether there is any infinite loop in the program which the task calls. 3. Redownload it after modifying the program.

System error code		Explanation	Correction
Hexadecimal	Decimal		
3068	12392	The actual time for executing the priority 24 task exceeds the set watchdog timeout time.	<ol style="list-style-type: none"> 1. Reset the watchdog time to a larger value for the task. 2. Check whether there is any infinite loop in the program which the task calls. 3. Redownload it after modifying the program.
3069	12393	The actual time for executing the priority 25 task exceeds the set watchdog timeout time.	Contact local technicians.
306A	12394	The actual time for executing the priority 26 task exceeds the set watchdog timeout time.	Contact local technicians.
306B	12395	The actual time for executing the priority 27 task exceeds the set watchdog timeout time.	Contact local technicians.
306C	12396	The actual time for executing the priority 28 task exceeds the set watchdog timeout time.	Contact local technicians.
306D	12397	The actual time for executing the priority 29 task exceeds the set watchdog timeout time.	Contact local technicians.
306E	12398	The actual time for executing the priority 30 task exceeds the set watchdog timeout time.	Contact local technicians.
306F	12399	The actual time for executing the priority 31 task exceeds the set watchdog timeout time.	Contact local technicians.
4000	16384	The reading and writing of the SD card data by the PLC failed.	<ol style="list-style-type: none"> 1. Check if the installation of the SD card is proper. 2. Check if the SD card is damaged.
4003	16387	The file in the SD card is read-only.	Modify the file in the SD card as the read-write file
4100	16640	The data in the project backup file is modified or the data format is incorrect.	<ol style="list-style-type: none"> 1. Ensure that the data in the project backup file is not modified. 2. Ensure that the project backup file is generated by CANopen Builder.
4101	16641	The data format of the RETAIN variable backup file is incorrect.	<ol style="list-style-type: none"> 1. Ensure that the data in the RETAIN variable backup file is not modified. 2. Ensure that the RETAIN variable backup file is generated by CANopen Builder.
4102	16642	During restoration, the data in the RETAIN variable backup file is partially different from that in the PLC.	Ensure that the data in the RETAIN variable backup file is consistent with that in the PLC.
4103	16643	During restoration, the data in the RETAIN variable backup file is completely different from that in the PLC.	Ensure that the data in the RETAIN variable backup file is consistent with that in the PLC.
4104	16644	During restoration, the controller model in the project backup file is different from that of the actually connected PLC.	Ensure that the controller model in the project backup file is the same as that of the actually connected PLC.
4105	16645	The program ID in the backup file is different from that of the current PLC.	Ensure that the program ID in the backup file is the same as that of the current PLC.
4106	16646	The PLC password in the backup file is different from that of the	Ensure that the PLC password in the backup

System error code		Explanation	Correction
Hexadecimal	Decimal		
		current PLC.	file is the same as that of the current PLC.
5000	20480	Extension communication checking failed.	Contact local technicians if the error still exists after repower on.
5001	20481	Extension communication timeout	
5100	20736	The module actually connected is inconsistent with that configured in the software.	Make sure that the module acutally connected to the right side of the PLC is consistent with that configured in the software and then re-download the configuration.
5200	20992	The buffer for receiving CANopen data is full.	Adjust the CANopen configuration and check the task setup.
5201	20993	The buffer for sending CANopen data is full.	
5300	21248	The buffer for receiving Motion data is full.	Adjust the Motion configuration and check the task setup.
5301	21249	The buffer for sending Motion data is full.	



Appendix A Modbus Communication

Table of Contents

A.1	Message Format in ASCII Mode	A-2
A.2	Message Format in RTU Mode	A-5
A.3	Modbus Function Codes Supported	A-7
A.4	Modbus Exception Response Code Supported	A-7
A.5	Introduction to Modbus Function Codes	A-8
A.6	Table of Registers and Corresponding Modbus addresses	A-15

A.1 Message Format in ASCII Mode

- Communication data structure

Field name	Components	Explanation
Start character	STX	Start character “:”, the corresponding ASCII code: 16#3A
Communication address	ADR 1	Communication address consists of two ASCII codes.
	ADR 0	
Function code	CMD 1	Function code consists of two ASCII codes.
	CMD 0	
Data	DATA (0)	Data content consists of 2n ASCII codes, n≤205.
	DATA (1)	
	
	DATA (n-1)	
LRC Check	LRC CHK 1	LRC check consists of two ASCII codes.
	LRC CHK 0	
End character	END1	End character consists of two ASCII codes. END1 = CR (16#0D), END0 = LF (16#0A)
	END0	

The corresponding relation between hexadecimal character and ASCII code:

Hexadecimal character	“0”	“1”	“2”	“3”	“4”	“5”	“6”	“7”
ASCII code	16#30	16#31	16#32	16#33	16#34	16#35	16#36	16#37
Hexadecimal character	“8”	“9”	“A”	“B”	“C”	“D”	“E”	“F”
ASCII code	16#38	16#39	16#41	16#42	16#43	16#44	16#45	16#46

- ADR (Communication address)

The valid range of communication address: 0~254.

Communication address: 0 means the broadcast message is sent to all slaves and the slaves which have received the message will not make any response. If communication address is not 0, slaves will respond to master after receiving the message normally. For instance, ASCII codes for the communication address of 16 are denoted below.

Decimal 16 is equal to hexadecimal 10. (ADR 1, ADR 0) = ‘10’, ‘1’=31H, ‘0’ = 30H

- Function code and data

The data format is determined by function codes. For example, to read the two continuous address data with hexadecimal 16#0000 as the start address in DVP-15MC series motion controller. The communication address of DVP-15MC series motion controller is 1, 16#0000 is the Modbus address of %MW0 in the controller.

The data explanation is shown as below:

PC→DVP-15MC series motion controller

3A 30 31 30 33 30 30 30 30 30 30 32 46 41 0D 0A

DVP-15MC series motion controller→PC

3A 30 31 30 33 30 34 30 30 30 31 30 30 30 32 46 35 0D 0A

■ Request message:

Field name	Field character	ASCII code corresponding to field character
Start character	“ : ”	3A
Communication address: 01	“0”	30
	“1”	31
Function code: 03	“0”	30
	“3”	33
Start address: 16#0000	“0”	30
	“0”	30
	“0”	30
	“0”	30
Data number (Counted by word): 2	“0”	30
	“0”	30
	“0”	30
	“2”	32
LRC check code: 16#FA	“F”	46
	“A”	41
End character 1	CR	0D
End character 0	LF	0A

■ Response message:

Field name	Field character	ASCII code corresponding to field character
Start character	“ : ”	3A
Communication address: 01	“0”	30
	“1”	31
Function code: 03	“0”	30
	“3”	33
Data number (Counted by byte):	“0”	30
	“4”	34
Read content of 16#1000 address	“0”	30
	“0”	30
	“0”	30
	“1”	31
Read content of 16#1001 address	“0”	30
	“0”	30
	“0”	30
	“2”	32

Field name	Field character	ASCII code corresponding to field character
LRC check code: 16#F5	"F"	46
	"5"	35
End character 1	CR	0D
End character 0	LF	0A

- LRC check (Check sum)

LRC check code is the value by firstly getting the inverse values of every bit of the result value of addition operation of the data from communication ID to the last data content (Hex.) and then adding 1 to the final inverse value.

For instance, LRC check code value: 16#FA. The method of calculating LRC check code value: $16\#01 + 16\#03 + 16\#00 + 16\#00 + 16\#00 + 16\#02 = 16\#06$, the result 16#FA is got by getting the inverse values of every bit of 16#06 and then adding 1 to the final inverse value.

Field name	Field character	ASCII code corresponding to field character
Start character	" : "	3A
Communication address: 01	"0"	30
	"1"	31
Function code: 03	"0"	30
	"3"	33
Start data address: 16#0000	"0"	30
	"0"	30
	"0"	30
	"0"	30
Data number (Counted by word):2	"0"	30
	"0"	30
	"0"	30
	"2"	32
LRC check code: 16#FA	"F"	46
	"A"	41
End character 1: CR	CR	0D
End character 0: LF	LF	0A

A.2 Message Format in RTU Mode

■ Communication data structure

Start	No input data for more than 10ms
Communication address	Slave address: 8-bit binary address
Function code	Function code: 8-bit binary address
Data (n-1)	Data content n × 8 bit binary data, n ≤ 202
.....	
Data 0	
Low byte of CRC check	CRC check sum
High byte of CRC check	
End	CRC check sum is composed of two 8-bit binary data

■ Communication address

The range of a valid communication address is 0~254. The communication address 0 indicates to broadcast the message to all slaves and the slaves which have received the broadcast message do not make any response. If the communication address is not 0, slaves will reply to master as normal. For example, to communication with the slave with the communication address of 16, the address of the slave is set as 16#10 since decimal 16 is equal to hexadecimal 10.

■ Function code and data

The data format is determined by function codes.

For example, to read the data of two continuous addresses with 16#0000 as start address in DVP-15MC series motion controller, the address of DVP-15MC is 1, 16#0000 is the Modbus address of %MW0 in the controller.

The data in the communication cable and the explanation on them are shown below:

PC→DVP-15MC series motion controller: "01 03 00 00 00 02 C4 0B"

DVP-15MC series motion controller→PC: "01 03 04 00 01 02 00 2A 32"

➤ Request message:

Field name	Character
Start	No input data for more than 10ms
Communication address	01
Function code	03
High byte of Modbus address	00
Low byte of Modbus address	00
Read high byte of data number	00
Read low byte of data number	02
Low byte of CRC check sum	C4
High byte of CRC check sum	0B
End	No input data for more than 10ms

➤ Response message:

Field name	Character
Start	No input data for more than 10ms
Communication address	01
Function code	03
Read data number (Counted by bytes)	04
Read high byte of data content	00
Read low byte of data content	01
Read high byte of data content	00
Read low byte of data content	02
Low byte of CRC check sum	2A
High byte of CRC check sum	32
End	No input data for more than 10ms

■ CRC check (check sum)

CRC check starts from "Communication address" to the last "Data content". The calculation method is shown below.

Step 1: Download a 16-bit hex register (CRC register) with the content value FFFF.

Step 2: Make the XOR operation between the 8-bit data of the first byte in the command and the 8-bit data of the low byte in CRC register and then store the operation result in CRC register.

Step 3: Move the content value of CRC register by one bit towards the right and fill 0 in the highest bit.

Step 4: Check the value of the lowest bit in CRC register. If the value is 0, repeat the action of step 3; if 1, make XOR operation between the content in CRC register and hex. A001 and then store the result in CRC register.

Step 5: Repeat step 3 and step 4 till the content in CRC register is moved by 8 bits towards the right. At this moment, the processing of the first byte of the command message is finished.

Step 6: Repeat the action of step 2 to step 5 for the next byte in the command message till the processing of all bytes is finished. The last content in CRC register is CRC check value. When CRC check value in command message is transmitted, the high and low bytes in calculated CRC check value must exchange with each other, i.e. the low byte is transmitted first.

Example on calculation of CRC check value with C language

```

unsigned char* data    ← // Pointer of command message content
unsigned char length  ← // Length of command message content
unsigned int crc_chk ( unsigned char* data, unsigned char length )
{
  int j;
  unsigned int reg_crc=0xffff;
  while ( length-- )
  {
    reg_crc ^= *data++;
    for ( j=0;j<8;j++ )
    {
      If ( reg_crc & 0x01 ) reg_crc= ( reg_crc>>1 ) ^ 0xa001; /* LSB ( b0 ) =1 */
      else reg_crc=reg_crc >>1;
    }
  }
}

```

```

return reg_crc;// the value that sent back to the CRC register finally
}

```

A.3 Modbus Function Codes Supported

- The function codes which are supported by DVP-15MC series motion controller are listed in the following table when COM2 port is possessed by the motion control module.

Function code	Explanation	Available register
16#01	Read output bit register values; the data of 256 bits at most can be read at a time	%QX
16#02	Read bit register values; the data of 256 bits at most can be read at a time	%IX,%QX
16#03	Read one single or multiple word register value; the data of 100 words at most can be read at a time.	%MW,%QW,%IW
16#05	Write one single bit register value.	%QX
16#06	Write one single word register value.	%MW,%QW
16#0F	Write multiple bit register value; the data of 256 bits at most can be written at a time.	%QX
16#10	Write multiple word register value; the data of 100 words at most can be written at a time.	%MW,%QW

A.4 Modbus Exception Response Code Supported

- Exception response codes supported by DVP-15MC series motion controller are listed in the following table.

Exception response code	Explanation
16#01	Illegal command codes: the command codes in the command message which PLC receives are invalid.
16#02	Illegal register address: the address in the command message received is invalid.
16#03	Illegal register value: the data in the command message received by PLC are invalid.
16#07	<ul style="list-style-type: none"> ◆ Check sum fault <ul style="list-style-type: none"> ✓ Check if the check sum is correct. ◆ Illegal command message <ul style="list-style-type: none"> ✓ Too short command message ✓ The length of the command message exceeds the valid range.

A.5 Introduction to Modbus Function Codes

- Function code 03 reads one single or multi word register values

- Data structure of a request message:

Byte NO.	Name	Byte
Byte0	Modbus ID	Single byte
Byte1	Function code	Single byte
Byte2	Read the start address of word registers in DVP-15MC series motion controller	High byte
Byte3		Low byte
Byte4	Read the number of addresses of word registers in DVP-15MC series motion controller (Counted by Word)	High byte
Byte5		Low byte
Byte6	Low byte of CRC check sum	Low byte
Byte7	High byte of CRC check sum	High byte

- Data structure of a response message:

Byte NO.	Name	Byte
Byte0	Modbus ID	Single byte
Byte1	Function code	Single byte
Byte2	Read the number of addresses of word registers in DVP-15MC series motion controller (Counted by Byte)	Single byte
Byte3	The address content of the word register in DVP-15MC series motion controller	High byte
Byte4		Low byte
...	The address content of the word register in DVP-15MC series motion controller	High byte
...		Low byte
Byte n	The address content of the word register in DVP-15MC series motion controller	High byte
Byte n+1		Low byte
Byte n+2	Low byte of CRC check sum	Low byte
Byte n+3	High byte of CRC check sum	High byte

- Data structure of an exception response message:

Byte NO.	Name	Byte
Byte0	Modbus ID	Single byte
Byte1	16#80+ function code	Single byte
Byte2	Exception response code	Single byte
Byte3	Low byte of CRC check sum	Low byte
Byte4	High byte of CRC check sum	High byte

■ **Example**

To read the contents of address 16#0000 and 16#0001 in DVP-15MC series motion controller via function code 03.

16#0000 and 16#0001 are the Modbus addresses of %MW0 and %MW1 in DVP-15MC series motion controller respectively.

Suppose the value of %MW0 is 16#0001 and %MW1 is 16#0002:

Request message: 01 03 00 00 00 02 C4 0B

Response message: 01 03 04 00 01 00 02 2A 32

- Function code 06 writes one single word register value

■ Data structure of a request message:

Byte NO.	Name	Byte
Byte0	Modbus ID	Single byte
Byte1	Function code	Single byte
Byte2	Controller's register address where to write the value	High byte
Byte3		Low byte
Byte4	The written value	High byte
Byte5		Low byte
Byte6	Low byte of CRC check sum	Low byte
Byte7	High byte of CRC check sum	High byte

■ Data structure of a response message:

Byte NO.	Name	Byte
Byte0	Modbus ID	Single byte
Byte1	Function code	Single byte
Byte2	Controller's word register address where to write the value	High byte
Byte3		Low byte
Byte4	The written value	High byte
Byte5		Low byte
Byte6	Low byte of CRC check sum	Low byte
Byte7	High byte of CRC check sum	High byte

■ Data structure of an exception response message:

Byte NO.	Name	Byte
Byte0	Modbus ID	Single byte
Byte1	16#80+ function code	Single byte
Byte2	Exception response code	Single byte
Byte3	Low byte of CRC check sum	Low byte
Byte4	High byte of CRC check sum	High byte

■ **Example**

Write 16#0100 to the address 16#0000 in DVP-15MC series motion controller via function code 06.

Request message: 01 06 00 00 01 00 88 5A

Response message: 01 06 00 00 01 00 88 5A

- Function code 16#10 writes multiple word register values

- Data structure of a request message:

Byte NO.	Name	Byte
Byte0	Modbus ID	Single byte
Byte1	Function code	Single byte
Byte2	The start address of controller's word registers where to write the value	High byte
Byte3		Low byte
Byte4	The number of addresses of controller's word registers where to write the value. (Counted by word)	High byte
Byte5		Low byte
Byte6	The number of addresses of controller's word registers where to write the value. (Counted by byte)	Single byte
Byte7	The address value written into controller's word register	High byte
Byte8		Low byte
...	The address value written into controller's word register	High byte
...		Low byte
Byte n	The address value written into controller's word register	High byte
Byte n+1		Low byte
Byte n+2	Low byte of CRC check sum	Low byte
Byte n+3	High byte of CRC check sum	High byte

- Data structure of a response message:

Byte NO.	Name	Byte
Byte0	Modbus ID	Single byte
Byte1	Function code	Single byte
Byte2	The start address of controller's word registers where to write the value	High byte
Byte3		Low byte
Byte4	The number of controller's word registers where to write the value. (Counted by Word)	High byte
Byte5		Low byte
Byte6	Low byte of CRC check sum	Low byte
Byte7	High byte of CRC check sum	High byte

- Data structure of an exception response message:

Byte NO.	Name	Byte
Byte0	Modbus ID	Single byte
Byte1	16#80+ function code	Single byte
Byte2	Exception response code	Single byte

Byte NO.	Name	Byte
Byte3	Low byte of CRC check sum	Low byte
Byte4	High byte of CRC check sum	High byte

■ **Example**

Write 16#0100 and 16#0200 to the addresses 16#0000 and 16#0001 in DVP-15MC series controller respectively via function code 16#10. 16#0000 and 16#0001 are Modbus addresses of %MW0 and %MW1 in DVP-15MC series controller respectively.

Request message: 01 10 00 00 00 02 04 01 00 02 00 F3 33

Response message: 01 10 00 00 00 02 41 C8

- Function code 16#01 reads multiple output bit register values

■ Data structure of a request message:

Byte NO.	Name	Byte
Byte0	Modbus ID	Single byte
Byte1	Function code	Single byte
Byte2	The start address of controller's bit registers to be read	High byte
Byte3		Low byte
Byte4	The number of controller's bit registers to be read	High byte
Byte5		Low byte
Byte6	Low byte of CRC check sum	Low byte
Byte7	High byte of CRC check sum	High byte

■ Data structure of a response message:

Byte NO.	Name	Byte
Byte0	Modbus ID	Single byte
Byte1	Function code	Single byte
Byte2	Read the number of bytes of bit registers.	Single byte
Byte3	Read the state value of the bit register.	Single byte
...	Read the state value of the bit register.	Single byte
Byte n	Read the state value of the bit register.	Single byte
Byte n+1	Low byte of CRC check sum	Low byte
Byte n+2	High byte of CRC check sum	High byte

■ Data structure of an exception response message:

Byte NO.	Name	Byte
Byte0	Modbus ID	Single byte
Byte1	16#80+ function code	Single byte
Byte2	Exception response message	Single byte
Byte3	Low byte of CRC check sum	Low byte
Byte4	High byte of CRC check sum	High byte

Note:

The value of Byte 2 in the response message is determined by the values of Byte 4 and Byte 5 in the request message. For example, the number of the read bit registers in the request message is A. Dividing A by 8 produces B. If the quotient is an integer, the number of bytes of bit registers in the response message is B. Otherwise the number of bytes will be B + 1.

See the example below for details.

- **Example**

Read the state value of %QX2.0~%QX3.4 in DVP-15MC series motion controller via function code 01. The address of %QX2.0 is 16#A010. Suppose the value of %QX2.0~%QX2.7 is 1000 0001 and %QX3.0~%QX3.4 is 1 0001.

Request message: 01 01 A0 10 00 0D DE 0A

Response message: 01 01 02 81 11 19 A0

- Function code 16#02 reads multiple bit register values

- Data structure of a request message:

Byte NO.	Name	Byte
Byte0	Modbus ID	Single byte
Byte1	Function code	Single byte
Byte2	The start address of controller's bit registers where to read the state	High byte
Byte3		Low byte
Byte4	Read the number of bit registers.	High byte
Byte5		Low byte
Byte6	Low byte of CRC check sum	Low byte
Byte7	High byte of CRC check sum	High byte

- Data structure of a response message:

Byte NO.	Name	Byte
Byte0	Modbus ID	Single byte
Byte1	Function code	Single byte
Byte2	Read the number of bytes of bit registers.	Single byte
Byte3	Read the state value of the bit register.	Single byte
...	Read the state value of the bit register.	Single byte
Byte n	Read the state value of the bit register.	Single byte
Byte n+1	Low byte of CRC check sum	Low byte
Byte n+2	High byte of CRC check sum	High byte

- Data structure of an exception response message:

Byte NO.	Name	Byte
Byte0	Modbus ID	Single byte
Byte1	16#80+ Function code	Single byte

Byte NO.	Name	Byte
Byte2	Exception response code	Single byte
Byte3	Low byte of CRC check sum	Low byte
Byte4	High byte of CRC check sum	High byte

Note:

The value of Byte 2 in the response message is determined by the values of Byte 4 and Byte 5 in the request message. For example, the number of the read bit registers in request message is A. Dividing A by 8 produces B. If the quotient is an integer, the number of bytes of bit registers in the response message is B. Otherwise the number of bytes will be B+ 1. See the example below for details.

- **Example**

Read the state value of %QX2.0~%QX3.4 in DVP-15MC series motion controller via function code 02. The address of %QX2.0 is 16#A010. Suppose %QX2.0~%QX2.7=1000 0001, %QX3.0~%QX3.4=1 0001.

Request message: 01 02 A0 10 00 0D 9A 0A

Response message: 01 02 02 81 11 19 E4

- Function code 16#05 writes one single bit register value

- Data structure of a request message:

Byte NO.	Name	Byte
Byte0	Modbus ID	Single byte
Byte1	Function code	Single byte
Byte2	Modbus address of the bit register	High byte
Byte3		Low byte
Byte4	The value written in the bit register	High byte
Byte5		Low byte
Byte6	Low byte of CRC check sum	Low byte
Byte7	High byte of CRC check sum	High byte

- Data structure of a response message:

Byte NO.	Name	Byte
Byte0	Modbus ID	Single byte
Byte1	Function code	Single byte
Byte2	Modbus address of the bit register	High byte
Byte3		Low byte
Byte4	The value written in the bit register	High byte
Byte5		Low byte
Byte6	Low byte of CRC check sum	Low byte

Byte7	High byte of CRC check sum	High byte
-------	----------------------------	-----------

- Data structure of an exception response message:

Byte NO.	Name	Byte
Byte0	Modbus ID	Single byte
Byte1	16#80+ Function code	Single byte
Byte2	Exception response code	Single byte
Byte3	Low byte of CRC check sum	Low byte
Byte4	High byte of CRC check sum	High byte

Note: The written value 16#0000 for the bit register in request message or response message indicates the value FALSE is written in the bit register; the written value 16#FF00 for the bit register indicates the value TRUE is written in the bit register.

- **Example**

The value of %QX0.0 in DVP-15MC series motion controller is set to TRUE and the address of %QX0.0 is set to 16#A000 via function code 05.

Request message: 01 05 A0 00 FF 00 AE 3A

Response message: 01 05 A0 00 FF 00 AE 3A

- Function code 16#0F writes multiple bit register values

- Data structure of a request message:

Byte NO.	Name	Byte
Byte0	Modbus ID	Single byte
Byte1	Function code	Single byte
Byte2	The start address of the bit registers where to write values	High byte
Byte3		Low byte
Byte4	The number of bit registers where to write values	High byte
Byte5		Low byte
Byte6	The number of bytes of bit registers where to write values	Single byte
Byte7	The value written to the bit register	Single byte
...	The value written to the bit register	Single byte
Byte n	The value written to the bit register	Single byte
Byte n+1	Low byte of CRC check sum	Low byte
Byte n+2	High byte of CRC check sum	High byte

■ Data structure of a response message:

Byte NO.	Name	Byte
Byte0	Modbus ID	Single byte
Byte1	Function code	Single byte
Byte2	The start address of bit registers where to write values	High byte
Byte3		Low byte
Byte4	The number of bit registers where to write values	High byte
Byte5		Low byte
Byte6	Low byte of CRC check sum	Low byte
Byte7	High byte of CRC check sum	High byte

■ Data structure of an exception response message:

Byte NO.	Name	Byte
Byte0	Modbus ID	Single byte
Byte1	16#80+ Function code	Single byte
Byte2	Exception response code	High byte
Byte3	Low byte of CRC check sum	Low byte
Byte4	High byte of CRC check sum	High byte

Note: How many bytes of data in the request message depend on the number of bit registers in the request message.

■ Example

The value of %QX0.0~%QX0.7 is set to 1000 0001 and the address of %QX0.0 is 16#A000 via function code 0F in DVP-15MC series motion controller.

Request message: 01 0F A0 00 00 08 01 81 26 55

Response message: 01 0F A0 00 00 08 76 0D

A.6 Table of Registers and Corresponding Modbus addresses

- Register numbers in the motion control module of DVP-15MC series and corresponding addresses are listed below:

Register name	Register number	Explanation	Address (hex)	Attribute
I	%IX0.0~%IX127.7	Bit registers	6000 ~ 63FF	Read only
Q	%QX0.0~%QX127.7		A000 ~ A3FF	Read/write
I	%IW0~%IW63	Word registers	8000 ~ 803F	Read only
Q	%QW0~%QW63		A000 ~ A03F	Read/write
M	%MW0~%MW32767		0000 ~ 7FFF	Read/write

MEMO

A



Appendix B Modbus TCP Communication

Table of Contents

B.1	Modbus TCP Message Structure	B-2
B.2	Modbus Function Codes Supported in Modbus TCP	B-2
B.3	Exception Response Code in Modbus TCP	B-3
B.4	Modbus Function Codes in Modbus TCP.....	B-3
B.5	Registers and Corresponding Modbus Addresses	B-12

B.1 Modbus TCP Message Structure

- Modbus TCP message structure

Byte NO.	Name		Explanation
Byte0	Transaction identifier	High byte	0
Byte1		Low byte	
Byte2	Protocol identifier	High byte	0
Byte3		Low byte	
Byte4	Modbus data length	High byte	The number of bytes of Modbus address and the data after it.
Byte5		Low byte	
Byte6	Modbus ID	Single byte	0 ~ 16#FF
Byte7	Function code	Single byte	
Byte8	Register address in the controller	High byte	0~16#FFFF
Byte9		Low byte	
Byte10	Modbus data	High byte	The number of bytes of Modbus data is determined by function code.

B.2 Modbus Function Codes Supported in Modbus TCP

- Modbus function codes which DVP-15MC series motion controller supports

Function code	Function	Register
16#02	Read bit register value; maximum 256 bits of data could be read at a time.	%IX and %QX
16#03	Read one single or multiple word register values; maximum 100 words of data could be read at a time.	%IW, %QW and %MW
16#05	Write one single bit register value.	% QX
16#06	Write one single word register value.	%QW and %MW
16#0F	Write multiple bit register values; maximum 256 bits of data could be written at a time.	% QX
16#10	Write multiple word register values; maximum 100 words of data could be written at a time.	%QW and %MW

B.3 Exception Response Code in Modbus TCP

- Modbus exception response codes that DVP-15MC series motion controller supports are shown in the table below.

Exception response code	Indication
16#01	Unsupportive function code
16#02	Unsupportive Modbus address
16#03	Data length exceeds the range

B.4 Modbus Function Codes in Modbus TCP

- Function code: 03 to read one single or multiple word register values
 - Request message data structure:

Byte NO.	Name	Byte
Byte0	Transaction identifier	High byte
Byte1		Low byte
Byte2	Protocol identifier	High byte
Byte3		Low byte
Byte4	Modbus data length	High byte
Byte5		Low byte
Byte6	Modbus ID	Low byte
Byte7	Function code	Single byte
Byte8	The start address of word registers to be read	High byte
Byte9		Low byte
Byte10	The number of word registers (Counted by Word)	High byte
Byte11		Low byte

- Response message data structure:

Byte NO.	Name	Byte
Byte0	Transaction identifier	High byte
Byte1		Low byte
Byte2	Protocol identifier	High byte
Byte3		Low byte
Byte4	Modbus data length	High byte
Byte5		Low byte
Byte6	Modbus ID	Single byte

Byte NO.	Name	Byte
Byte7	Function code	Single byte
Byte8	The number of read word registers. (Counted by Byte)	Single byte
Byte9	The content value in a word register	High byte
Byte10		Low byte
...	The content value in a word register	High byte
Byte n		Low byte

■ **Exception response message data structure:**

Byte NO.	Name	Byte
Byte0	Transaction identifier	High byte
Byte1		Low byte
Byte2	Protocol identifier	High byte
Byte3		Low byte
Byte4	Modbus data length	High byte
Byte5		Low byte
Byte6	Modbus ID	Single byte
Byte7	16#80+ function code	Single byte
Byte8	Exception response code	Single byte

■ **Example**

To read the content value in the addresses 16#0000 and 16#0001 inside DVP-15MC series motion controller via function code 03. 16#0000 and 16#0001 are the Modbus address of %MW0 and %MW1 inside DVP-15MC series motion controller respectively. Suppose that the value of %MW0 is 16#0100 and the value of %MW1 is 16#0200.

Request message: 00 00 00 00 00 06 01 03 00 00 00 02

Response message: 00 00 00 00 00 07 01 03 04 01 00 02 00

● **Function code: 06 to write one single word register value**

■ **Request message data structure:**

Byte NO.	Name	Byte
Byte0	Transaction identifier	High byte
Byte1		Low byte
Byte2	Protocol identifier	High byte
Byte3		Low byte
Byte4	Modbus data length	High byte
Byte5		Low byte

Byte NO.	Name	Byte
Byte6	Modbus ID	Single byte
Byte7	Function code	Single byte
Byte8	The address of a word register where to write value	High byte
Byte9		Low byte
Byte10	The value written in the word register	High byte
Byte11		Low byte

■ **Response message data structure:**

Byte NO.	Name	Byte
Byte0	Transaction identifier	High byte
Byte1		Low byte
Byte2	Protocol identifier	High byte
Byte3		Low byte
Byte4	Modbus data length	High byte
Byte5		Low byte
Byte6	Modbus ID	Single byte
Byte7	Function code	Single byte
Byte8	The address of a word register where to write a value	High byte
Byte9		Low byte
Byte10	The value written in a word register	High byte
Byte11		Low byte

■ **Exception response message data structure:**

Byte NO.	Name	Byte
Byte0	Transaction identifier	High byte
Byte1		Low byte
Byte2	Protocol identifier	High byte
Byte3		Low byte
Byte4	Modbus data length	High byte
Byte5		Low byte
Byte6	Modbus ID	Single byte
Byte7	16#80+ function code	Single byte
Byte8	Exception response code	Single byte

■ **Example:**

To write the value 16#0100 to the address 16#0000 in DVP-15MC series motion controller via function code 06

Request message: 00 00 00 00 00 06 01 06 00 00 01 00

Response message: 00 00 00 00 00 06 01 06 00 00 01 00

● **Function code: 16#10 to write multiple word register values**

■ **Request message data structure:**

Byte NO.	Name	Byte
Byte0	Transaction identifier	High byte
Byte1		Low byte
Byte2	Protocol identifier	High byte
Byte3		Low byte
Byte4	Modbus data length	High byte
Byte5		Low byte
Byte6	Modbus ID	Single byte
Byte7	Function code	Single byte
Byte8	The start address of word registers where to write values	High byte
Byte9		Low byte
Byte10	The number of word registers where to write values (Counted by Word)	High byte
Byte11		Low byte
Byte12	The number of word registers where to write values (Counted by Byte)	Single byte
Byte13	The value written in a word register	High byte
Byte14		Low byte
...	The value written in a word register	High byte
Byte n		Low byte

■ **Response message data structure:**

Byte NO.	Name	Byte
Byte0	Transaction identifier	High byte
Byte1		Low byte
Byte2	Protocol identifier	High byte
Byte3		Low byte
Byte4	Modbus data length	High byte

Byte NO.	Name	Byte
Byte5		Low byte
Byte6	Modbus ID	Single byte
Byte7	Function code	Single byte
Byte8	The start address of word registers where to write values	High byte
Byte9		Low byte
Byte10	The number of word registers where to write values. (Counted by Word)	High byte
Byte11		Low byte

■ **Exception response message data structure:**

Byte NO.	Name	Byte
Byte0	Transaction identifier	High byte
Byte1		Low byte
Byte2	Protocol identifier	High byte
Byte3		Low byte
Byte4	Modbus data length	High byte
Byte5		Low byte
Byte6	Modbus ID	Single byte
Byte7	16#80+ function code	Single byte
Byte8	Exception response code	Single byte

Note:

How many bytes of data in a response message depend on the number of read register addresses in DVP-15MC series motion controller in the request message. So the value of n in Byte n in the response message can be calculated through reading the number of register addresses in DVP-15MC series motion controller.

■ **Example**

To write 16#0100 and 16#0200 to the addresses 16#0000 and 16#0001 in DVP-15MC series motion controller via function code 06.

16#0000 and 16#0001 are the Modbus addresses of %MW0 and %MW1 in DVP-15MC series motion controller respectively.

Request message: 00 00 00 00 00 0B 01 10 00 00 00 02 04 01 00 02 00

Response message: 00 00 00 00 00 06 01 10 00 00 00 02

- **Function code: 16#02 to read multiple bit register values**

- **Request message data structure:**

Byte NO.	Name	Byte
Byte0	Transaction identifier	High byte
Byte1		Low byte
Byte2	Protocol identifier	High byte
Byte3		Low byte
Byte4	Modbus data length	High byte
Byte5		Low byte
Byte6	Modbus ID	Single byte
Byte7	Function code	Single byte
Byte8	The start address of the read bit registers	High byte
Byte9		Low byte
Byte10	The number of read bit registers	High byte
Byte11		Low byte

- **Response message data structure:**

Byte NO.	Name	Byte
Byte0	Transaction identifier	High byte
Byte1		Low byte
Byte2	Protocol identifier	High byte
Byte3		Low byte
Byte4	Modbus data length	High byte
Byte5		Low byte
Byte6	Modbus ID	Single byte
Byte7	Function code	Single byte
Byte8	How many bytes for the read bit registers	Single byte
Byte9	The status value of a bit register which is read	Single byte
...	The status value of a bit register which is read	Single byte
Byte n	The status value of a bit register which is read	Single byte

■ **Exception response message data structure:**

Byte NO.	Name	Byte
Byte0	Transaction identifier	High byte
Byte1		Low byte
Byte2	Protocol identifier	High byte
Byte3		Low byte
Byte4	Modbus data length	High byte
Byte5		Low byte
Byte6	Modbus ID	Single byte
Byte7	16#80+ function code	Single byte
Byte8	Exception response code	Single byte

■ **Example**

To read the state value of %QX2.0~%QX3.4 in DVP-15MC series motion controller via function code 02. 16#A010 is the address of %QX2.0. Suppose that %QX2.0~%QX2.7=1000 0001 and %QX3.0~%QX3.4=10001.

Request message: 00 00 00 00 00 06 01 02 A0 10 00 0D

Response message: 00 00 00 00 00 06 01 02 02 81 11

● **Function code: 16#05 to write one single bit register value**

■ **Request message data structure:**

Byte NO.	Name	Byte
Byte0	Transaction identifier	High byte
Byte1		Low byte
Byte2	Protocol identifier	High byte
Byte3		Low byte
Byte4	Modbus data length	High byte
Byte5		Low byte
Byte6	Modbus ID	Single byte
Byte7	Function code	Single byte
Byte8	Modbus address of a bit register	High byte
Byte9		Low byte
Byte10	The value written in the bit register	High byte
Byte11		Low byte

■ **Response message data structure:**

Byte NO.	Name	Byte
Byte0	Transaction identifier	High byte
Byte1		Low byte
Byte2	Protocol identifier	High byte
Byte3		Low byte
Byte4	Modbus data length	High byte
Byte5		Low byte
Byte6	Modbus ID	Single byte
Byte7	Function code	Single byte
Byte8	Modbus address of a bit register	High byte
Byte9		Low byte
Byte10	The value written in the bit register	High byte
Byte11		Low byte

■ **Exception response message data structure:**

Byte NO.	Name	Byte
Byte0	Transaction identifier	High byte
Byte1		Low byte
Byte2	Protocol identifier	High byte
Byte3		Low byte
Byte4	Modbus data length	High byte
Byte5		Low byte
Byte6	Modbus ID	Single byte
Byte7	16#80+ function code	Single byte
Byte8	Exception response code	Single byte

Note: The written value 16#0000 means that 0 is written to the bit register and 16#FF00 means that 1 is written to the bit register.

■ **Example**

Set the value of %QX0.0 in DVP-15MC series motion controller to 1 via function code 05; the address of %QX0.0 is 16#A000.

Request message: 00 00 00 00 00 06 01 05 A0 00 FF 00

Response message: 00 00 00 00 00 06 01 05 A0 00 FF 00

- **Function code: 16#0F to write multiple bit register values.**

- **Request message data structure:**

Byte NO.	Name	Byte
Byte0	Transaction identifier	High byte
Byte1		Low byte
Byte2	Protocol identifier	High byte
Byte3		Low byte
Byte4	Modbus data length	High byte
Byte5		Low byte
Byte6	Modbus ID	Single byte
Byte7	Function code	Single byte
Byte8	The start address of the bit registers where to write values	High byte
Byte9		Low byte
Byte10	The number of bit registers where to write values	High byte
Byte11		Low byte
Byte12	How many bytes occupied by bit registers where to write values	Single byte
Byte13	The value written in a bit register	Single byte
Byte n	The value written in a bit register	Single byte

- **Response message data structure**

Byte NO.	Name	Byte
Byte0	Transaction identifier	High byte
Byte1		Low byte
Byte2	Protocol identifier	High byte
Byte3		Low byte
Byte4	Modbus data length	Single byte
Byte5	Modbus ID	High byte
Byte6		Low byte
Byte7	Function code	Single byte
Byte8	The start address of bit registers where to read status	High byte
Byte9		Low byte
Byte10	The number of bit registers where to write values	High byte
Byte 11		Low byte

■ **Exception response message data structure**

Byte NO.	Name	Byte
Byte0	Transaction identifier	High byte
Byte1		Low byte
Byte2	Protocol identifier	High byte
Byte3		Low byte
Byte4	Modbus data length	High byte
Byte5		Low byte
Byte6	Modbus ID	Single byte
Byte7	16#80+ function code	Single byte
Byte8	Exception response code	Single byte

■ **Example**

Set %QX0.0~%QX0.7=1000 0001 via function code 0F and set the address of %QX0.0 to 16#A000 in DVP-15MC series motion controller.

Request message: 00 00 00 00 00 0A 01 0F A0 00 00 08 01 81

Response message: 00 00 00 00 00 06 01 0F A0 00 00 08

B.5 Registers in DVP-15MC Series and Corresponding Modbus Addresses

Register name	Register no.	Explanation	Address (hex)	Attribute
I	%IX0.0~%IX127.7	Bit register	6000 ~ 63FF	Read only
Q	%QX0.0~%QX127.7		A000 ~ A3FF	Read/write
I	%IW0~%IW63	Word register	8000 ~ 803F	Read only
Q	%QW0~%QW63		A000 ~ A03F	Read/write
M	%MW0~%MW32767		0000 ~ 7FFF	Read/write



Appendix C CANopen Protocol

Table of Contents

C.1	Node States	C-4
C.2	Network Management (NMT)	C-6
C.3	PDO (Process Data Object)	C-6
C.4	SDO (Service Data Object)	C-8

● **About CANopen protocol**

The CAN (controller area network) fieldbus only defines the physical layer and data link layer. (See ISO11898 standard.) It does not define the application layer. In the practical design, the physical layer and the data link layer are realized by the hardware. The CAN fieldbus itself is not complete. It needs the superior protocol to define the use of 11/29-bit identifier and 8-byte data.

The CANopen protocol is the CAN-based superior protocol. It is one of the protocols defined and maintained by CiA (CAN-in-Automation). It is developed on the basis of the CAL (CAN application layer) protocol, using a subset of the CAL communication and service protocols.

The CANopen protocol covers the application layer and the communication profile (CiA DS301). It also covers a framework for programmable registers (CiA 302), the recommendations for cables and connectors (CiA 303-1), and SI units and prefix representations (CiA 303-2).

In the OSI model, the relation between the CAN standard and the CANopen protocol is as follows.

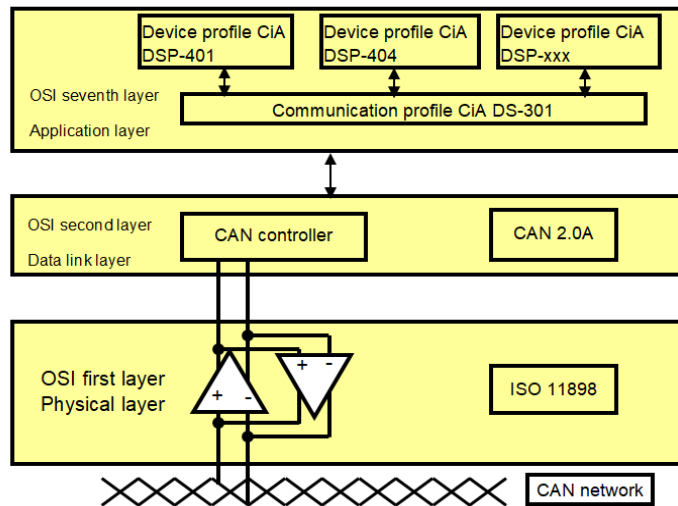

● **The object dictionary**

- CANopen uses an object-based way to define a standard device. Every device is represented by a set of objects, and can be visited by the network. The model of the CANopen device is illustrated below. As the figure below shows, the object dictionary is the interface between the communication program and the superior application program.
- The core concept of CANopen is the device object dictionary (OD). It is an orderly object set. Every object adopts a 16-bit index for addressing. In order to allow the visit to the single element in the data structure, it also defines an 8-bit subindex. Every node in the CANopen network has an object dictionary. The object dictionary includes the parameters which describe the device and the network behavior. The object dictionary of a node is described in the electronic data sheet.

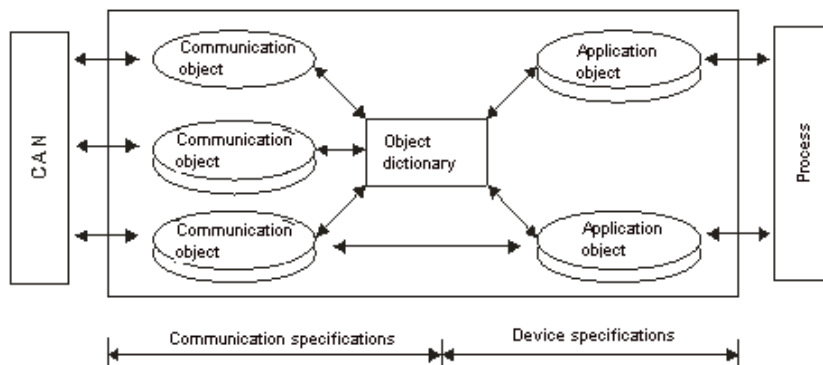

- **The CANopen Communication Object**

The CANopen communication protocol contains PDO, SDO, NMT and other predefined CANopen communication object.

Refer to section C.3 for PDO introduction.

Refer to section C.4 for SDO introduction.

Refer to section C.2 for NMT introduction.

- **Other predefined CANopen communication objects (SYNC and EMCY)**

- **SYNC Object (Synchronous object)**

The synchronous object is the message broadcasted periodically by the master node in the CANopen network. This object is used to realize the network clock signal. Every device decides whether to use the event and undertake the synchronous communication with other network devices according to its configuration. For example, when controlling the driving device, the devices do not act immediately after they receive the command sent by the master. They do act until they receive the synchronous message. In this way, many devices can act synchronously.

The format of the SYNC message:

COB-ID
80 (hex)

- **Emergency Object**

The emergency object is used by the CANopen device to indicate an internal error. When an emergency error occurs in the device, the device sent the emergency message (including the emergency error code), and the device enters the error state. After the error is eliminated, the device sends the emergency message, the emergency error code is 0, and the device enters the normal state.

The format of the emergency message:

COB-ID	Byte 0	Byte 1	Byte 2	Byte 3	Byte 4	Byte 5	Byte 6	Byte 7
80 (hex) +Node-ID	Emergency error code		Error register	Factory-defined error code				
	LSB	MSB						

Note: The value in the error register is mapped to index 1001 (hex) in the object dictionary. If the value is 0, no error occurs. If the value is 1, a general error occurs. If the value is H'80, an internal error occurs in the device.

C.1 Node States

- **Module control services**

The master node in the CANopen network controls the slave by sending the command. The slave executes the command after it receives the command and it does not need to reply. All CANopen nodes have internal NMT states. The slave node has four states, Initializing, Pre-operational, Operational, and Stop state.

The state of the device is illustrated below.

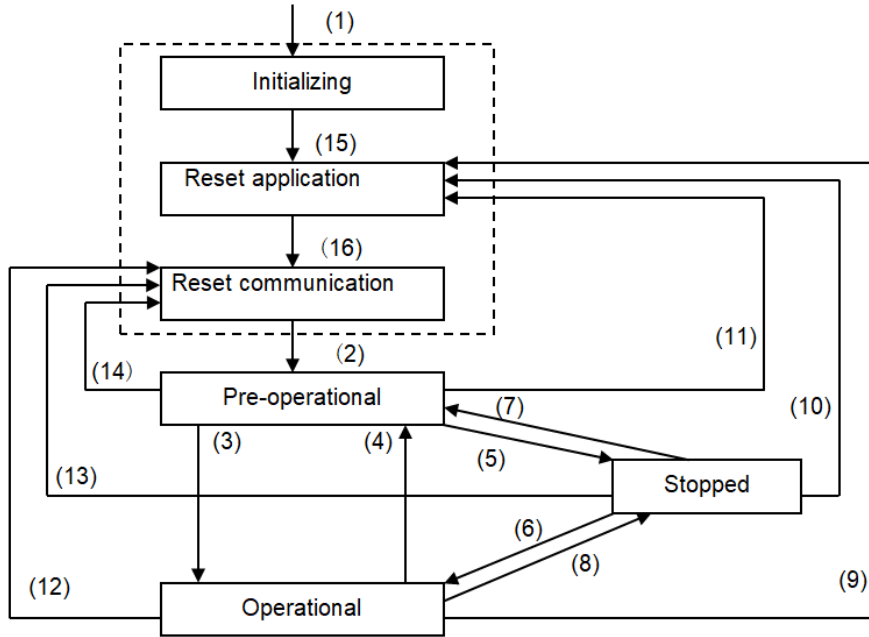

- (1) After the power is supplied, the device automatically enters the initialization state.
- (2) After the initialization is complete, the device automatically enters the Pre-operational state.
- (3)(6) The remote node is started.
- (4)(7) The device enters the Pre-operational state.
- (5)(8) The remote node is stopped.
- (9)(10)(11) The application layer is reset.
- (12)(13)(14) The communication is reset.
- (15) After the initializing is complete, the device automatically enters the “reset application” state.
- (16) After the “reset application” state is complete, the device automatically enters the “reset communication” state.

The relation between the communication object and the state is shown below. The communication object service can be executed only in a proper state. For example, SDO can be executed only in the operational state and in the pre-operational state.

	Initialization	Pre-operational	Operational	Stopped
PDO			X	
SDO		X	X	
SYNC		X	X	
Time Stamp		X	X	
EMCY		X	X	
Boot-up	X			
NMT		X	X	X

The format of the control message for the node state:

COB-ID	Byte 0	Byte 1
0	Command specifier (CS)	Slave address (0: Broadcast)

The command specifiers are listed below.

Command specifier (hex)	Function
01	Start the remote node
02	Stop the remote node
80	Enter the pre-operational state
81	Reset the application layer
82	Reset the communication

- **Error Control services**

The error control service is used to detect the disconnection of the node in the network. The error control services can be classified into two types, Heartbeat and Node Guarding. The PLC only supports Heartbeat. For example, the master can detect the disconnection of the slave only after the slave enables the Heartbeat service.

The Heartbeat principle is illustrated as follows. The Heartbeat producer transmits the Heartbeat message according to the Heartbeat producing time which is set. One or more Heartbeat consumers detect the message transmitted by the Heartbeat producer. If the consumer does not receive the message transmitted by the producer within the timeout period, the heartbeat event generated indicates that the CANopen communication is abnormal.

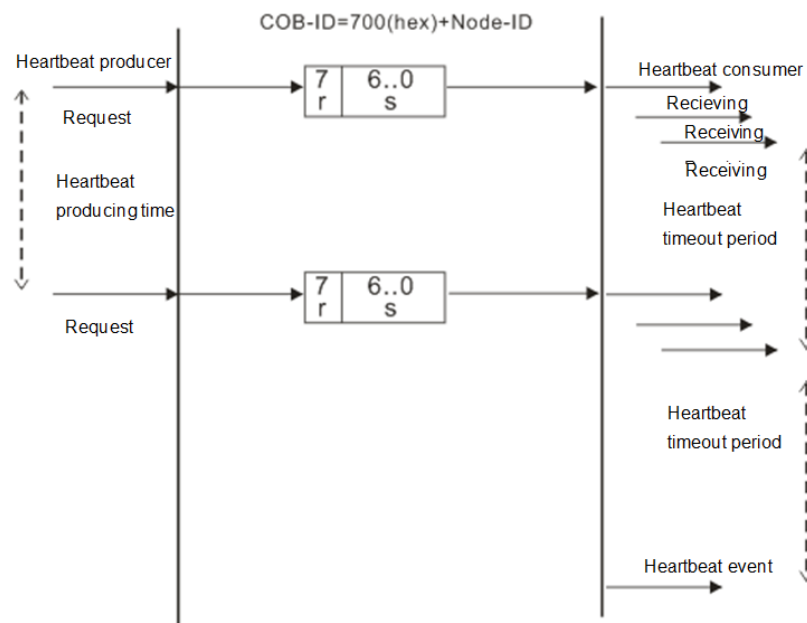

- **Boot-up services**

After the slave completes entering the pre-operational state, it will transmit a Boot-up message, which indicates the initializing is completed.

C.2 Network Management (NMT)

The CANopen network management complies with the Master/Slave mode. Only one NMT master can exist and other nodes are considered as slaves in a CANopen network. NMT contains three types of services, Module control services, Error Control services and Boot-up services. Please refer to section C.1 of the manual for more details.

C.3 PDO (Process Data Object)

- **PDO**

- The PDO provides the direct visit channel for the device application object, is used to transmit the real-time data, and has high priority. Every byte in the PDO CAN message data list is used to transmit the data. The rate of making use of the message is high.
- The PDO is described by means of the “producer/consumer mode”. The data is transmitted from one producer to one or many consumers. The data which can be transmitted are limited to 1-byte data to 8-byte data. After the data is transmitted by the producer, the consumer does not need to reply to the data. Every node in the network will detect the data information transmitted by the transmission node, and decides whether to process the data which is received.
- There are two kinds of PDO services for every PDO: TxPDO and RxPDO. The PDO sent by the producer is called PDO (TxPDO) sent by the producer device. And the PDO the consumer receives is called PDO (RxPDO) which the consumer device receives.
- Every PDO is described with two objects in the object dictionary: The PDO communication parameters and the PDO mapping parameters.

The PDO communication parameters:

Include the COB-ID which will be used by PDO, transmission type, prohibition time and the cycle of the counter.

The PDO mapping parameters:

Contain the object list in an object dictionary. These objects are mapped into the PDO, including the data length (in bits). To explain the contents of the PDO, the producer and the consumer have to understand the mapping.

- The PDO transmission modes: synchronous and asynchronous
 Synchronous: Synchronous periodic and synchronous non-periodic
 Asynchronous: The PDO is transmitted when the data is changed, or it is transmitted after an event trigger.

➤ The transmission modes supported by PDO are as follows.

	Type		PDO transmission		
	Periodic	Non-periodic	Synchronous	Asynchronous	RTR
0		X	X		
1 – 240	X		X		
254				X	
255				X	

Mode 0: The PDO information is transmitted only when the PDO data is changed and the synchronous signal comes.

Modes 1~240: One piece of PDO information is transmitted every 1~240 synchronous signals.

Mode 254: The event trigger transmission is defined by the manufacturer. For DVP-15MC series motion controller, the definition is the same as mode 255.

Mode 255: PDO is transmitted when the data is changed, or it is transmitted after an event trigger.

- All the data in the PDO has to be mapped from the object dictionary. The following is an example of the PDO mapping.

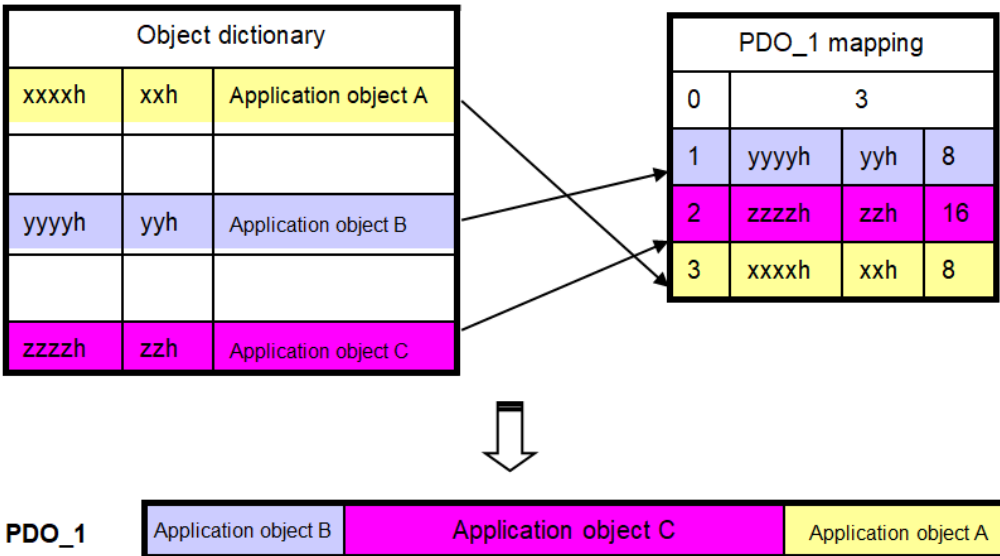

- The data format for RxPDO and TxPDO is as follows.

COB-ID	Byte 0	Byte 1	Byte 2	Byte 3	Byte 4	Byte 5	Byte 6	Byte 7
Object identifier	Data							

C.4 SDO (Service Data Object)

- SDO

- The SDO is used to build the client/server relation between two CANopen devices. The client device can read the data from the object dictionary of the server device, and write the data into the object dictionary of the server device. The access mode of the SDO is “client/server” mode. The mode which is accessed is the SDO server. Every CANopen device has at least one service data object which provides the access channel to the object dictionary of the device. SDO can read all objects in the object dictionary, and write all objects into the object dictionary.
- The SDO message contains the index information and the subindex information which can be used to position the objects in the object dictionary, and the composite data structure can easily pass the SDO access. The trigger method of SDO belongs to the type of command response. In other words, the SDO server must reply after the SDO client sends a read/write request. The client and the server can stop the transmission of the SDO. The request message and response message can be differentiated according to their different COB-IDs.
- The SDO can transmit the data in any length. If the data length is more than 4 bytes, the data has to be transmitted by segment. The last segment of the data contains an end flag. The structures of the SDO requested message and reply message are as follows. The formats of the request message and response message:

➢ The format of the request message

COB-ID	Byte 0	Byte 1	Byte 2	Byte 3	Byte 4	Byte 5	Byte 6	Byte 7
600 (hex) +Node-ID	Request code	Object index		Object index	Requested data			
		LSB	MSB		bit7-0	bit15-8	bit23-16	bit31-24

➢ The definition of the request code in the request message:

Request code (hex)	Description
23	Writing the 4-byte data
2B	Writing the 2-byte data
2F	Writing the 1-byte data
40	Reading the data
80	Stopping current SDO function

➢ The format of the response message

COB-ID	Byte 0	Byte 1	Byte 2	Byte 3	Byte 4	Byte 5	Byte 6	Byte 7
580 (hex) +Node-ID	Response code	Object index		Object subindex	Response data			
		LSB	MSB		bit7-0	bit15-8	bit23-16	bit31-24

➢ The definition of the response code in the response message:

Response code (hex)	Description
43	Reading the 4-byte data
4B	Reading the 2-byte data
4F	Reading the 1-byte data
60	Writing the 1/2/4-byte data
80	Stopping the SDO function



Appendix D Explanation of Homing Modes

Table of Contents

D.1 Explanation of Homing Modes	D-2
--	------------

D.1 Explanation of Homing Modes

DVP-15MC series motion controller provides many homing modes from which user can choose the appropriate one in accordance with the field condition and technical requirement.

➤ Mode 1 Homing which depends on the negative limit switch and Z pulse.

Circumstance 1 : MC_Home instruction is executed when the negative limit switch is OFF and the axis moves in the negative direction at the first-phase speed. The motion direction changes and the axis moves at the second-phase speed when the axis encounters that the negative limit switch is ON. Where the first Z pulse is met is the home position when the negative limit switch is OFF.

Circumstance 2 : MC_Home instruction is executed when the negative limit switch is ON and the axis moves in the positive direction at the second-phase speed. Where the first Z pulse is met is the home position when the negative limit switch is OFF.

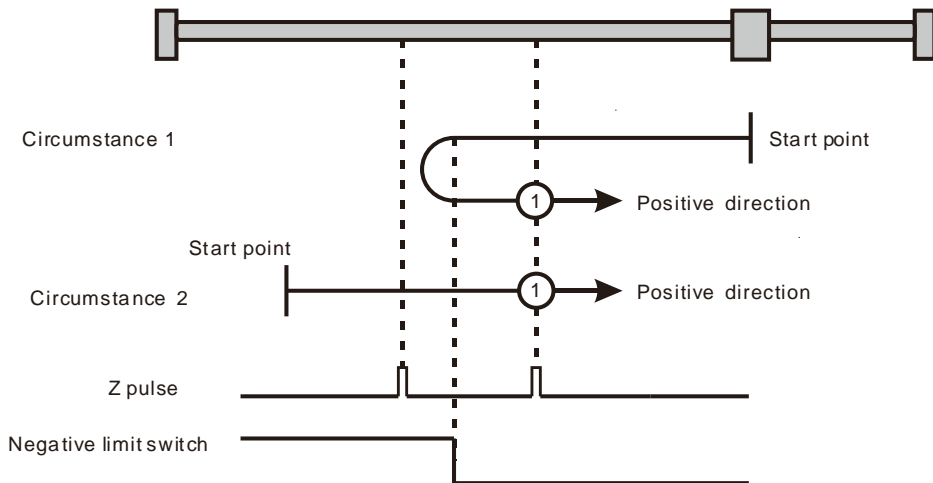

Homing depending on the negative limit switch and Z pulse (①: mode 1)

➤ Mode 2 Homing which depends on the positive limit switch and Z pulse

Circumstance 1 : MC_Home instruction is executed when the positive limit switch is OFF and the axis moves in the positive direction at the first-phase speed. The motion direction changes and the axis moves at the second-phase speed when the axis encounters that the positive limit switch is ON. Where the first Z pulse is met is the home position while the positive limit switch is OFF.

Circumstance 2 : MC_Home instruction is executed when the positive limit switch is ON and the axis moves in the negative direction at the second-phase speed. Where the first Z pulse is met is the home position while the positive limit switch is OFF.

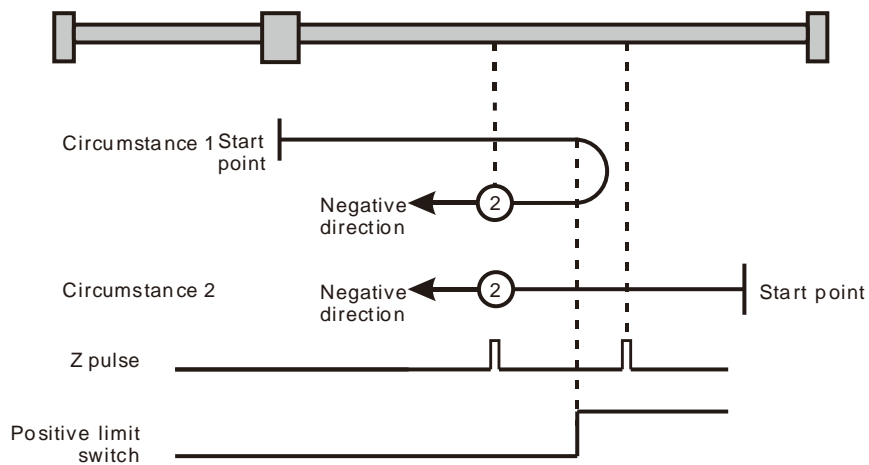

Homing depending on the positive limit switch and Z pulse (Ⓢ: mode 2)

Mode 3 and mode 4 Homing which depends on the home switch and Z pulse

➤ Mode 3

Circumstance 1 : When the home switch is OFF, MC_Home instruction is executed and the axis moves in the positive direction at the first-phase speed. When the axis encounters that the home switch is ON, the motion direction changes and the axis moves at the second-phase speed. Where the first Z pulse is met is the home position when the home switch is OFF.

Circumstance 2 : When the home switch is ON, MC_Home instruction is executed and the axis directly moves in the negative direction at the second-phase speed. Where the first Z pulse is met is the home position while the home switch is OFF.

➤ Mode 4

Circumstance 1 : When the home switch is OFF, MC_Home instruction is executed and the axis moves in the positive direction at the first-phase speed. The axis moves at the second-phase speed when the axis encounters that the home switch is ON. Where the first Z pulse is met is the home position.

Circumstance 2 : When the home switch is ON, MC_Home instruction is executed and the axis moves in the negative direction at the second-phase speed. When the axis encounters that the home switch is OFF, the motion direction changes and the axis moves at the second-phase speed. Where the first Z pulse is met is the home position.

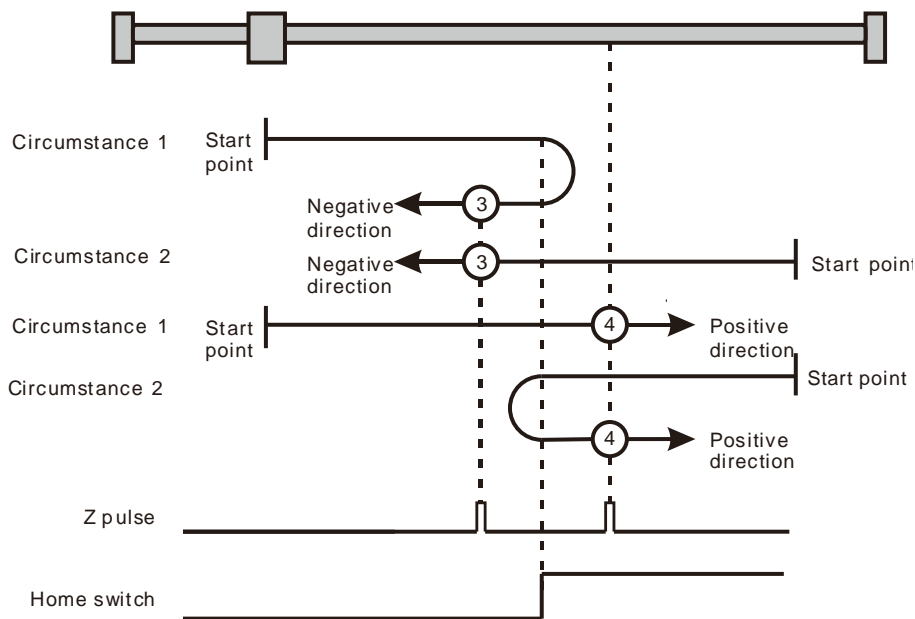

Homing depending on the home switch and Z pulse (③: mode 3; ④: mode 4)

D

Mode 5 and mode 6 Homing which depends on the home switch and Z pulse

➤ Mode 5

Circumstance 1 : When the home switch is ON, MC_Home instruction is executed and the axis moves in the positive direction at the second-phase speed. Where the first Z pulse is met is the home position while the home switch is OFF.

Circumstance 2 : When the home switch is OFF, MC_Home instruction is executed and the axis moves in the negative direction at the first-phase speed. When the home switch is ON, the motion direction changes and the axis moves at the second-phase speed. Where the first Z pulse is met is the home position when the home switch is OFF.

➤ Mode 6

Circumstance 1 : When the home switch is ON, MC_Home instruction is executed and the axis moves in the positive direction at the second-phase speed. When the home switch is OFF, the motion direction changes and the axis moves at the second-phase speed. Where the first Z pulse is met is the home position.

Circumstance 2 : When the home switch is OFF, MC_Home instruction is executed and the axis moves in the negative direction at the first-phase speed. While the home switch is ON, the axis moves at the second-phase speed and where the first Z pulse is met is the home position.

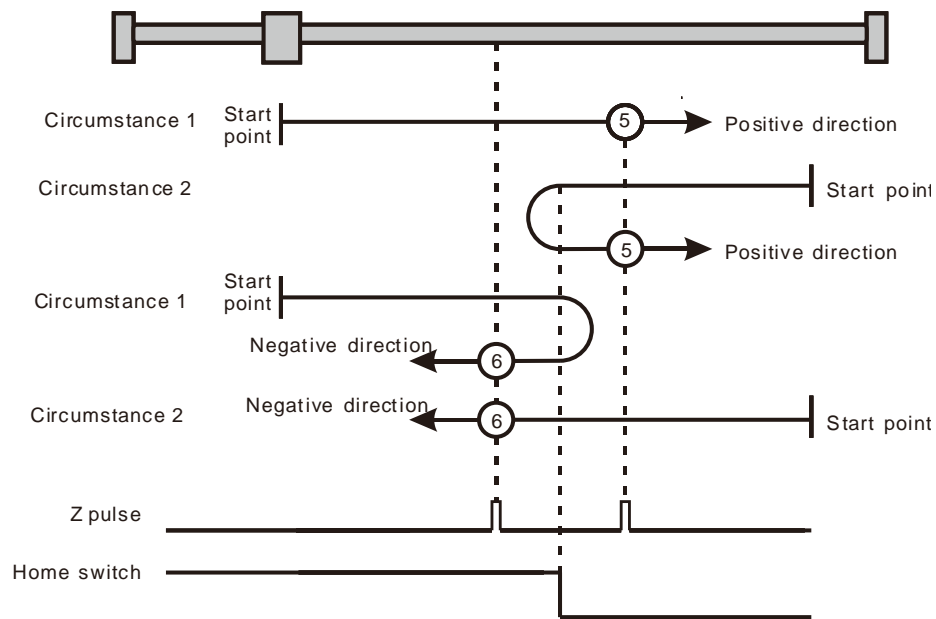

Homing depending on the home switch and Z pulse (⊙: mode 5, ⊙: mode 6)

Mode 7~ mode 10 Homing which depending on the home switch, positive limit switch and Z pulse

➤ Mode 7

- Circumstance 1 :** When the home switch is OFF, MC_Home instruction is executed and the axis moves in the positive direction at the first-phase speed. The motion direction changes and the axis moves at the second-phase speed when the home switch is ON. Where the first Z pulse is met is the home position when the home switch is OFF.
- Circumstance 2 :** When the home switch is ON, MC_Home instruction is executed and the axis moves in the negative direction at the second-phase speed. Where the first Z pulse is met is the home position when the home switch is OFF.
- Circumstance 3 :** When the home switch is OFF, MC_Home instruction is executed and the axis moves in the positive direction at the first-phase speed. The motion direction changes and the axis moves at the first-phase speed when the home switch is OFF and the positive limit switch is ON. The axis starts to move at the second-phase speed when the home switch is ON. Where the first Z pulse is met is the home position when the home switch is OFF.

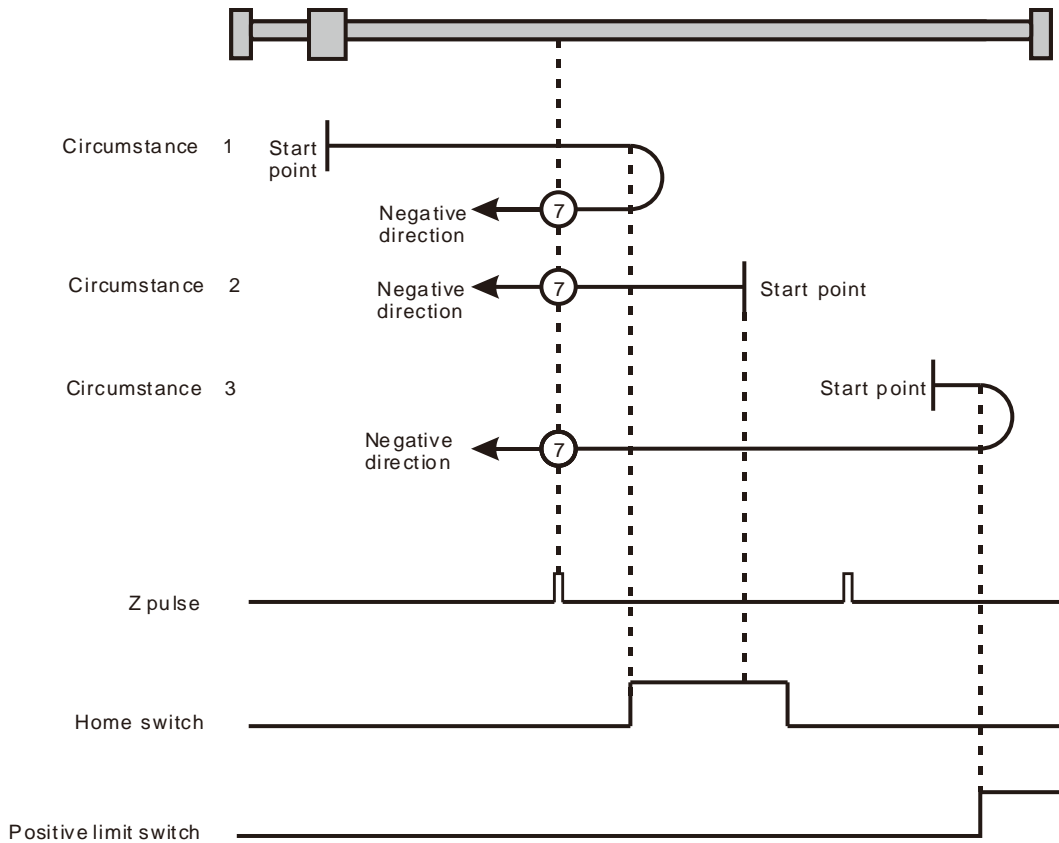

Homing depending on the home switch, positive limit switch and Z pulse (⊙: mode 7)

D

➤ Mode 8

Circumstance 1 : When the home switch is OFF, MC_Home instruction is executed and the axis moves in the positive direction at the first-phase speed. The axis moves at the second-phase speed when the home switch is ON and where the first Z pulse is met is the home position.

Circumstance 2 : MC_Home instruction is executed and the axis moves in the negative direction at the second-phase speed when the home switch is ON. The motion direction changes and the axis moves at the second-phase speed when the home switch is OFF. And where the first Z pulse is met is the home position.

Circumstance 3 : When the home switch is OFF, MC_Home instruction is executed and the axis moves in the positive direction at the first-phase speed. The motion direction changes and the axis moves at the first-phase speed when the home switch is OFF and the positive limit switch is ON. The axis still moves at the first-phase speed when the home switch is ON. The motion direction changes and the axis moves at the first-phase speed when the home switch is OFF. The axis moves at the second-phase speed and where the first Z pulse is met is the home position when the home switch is ON.

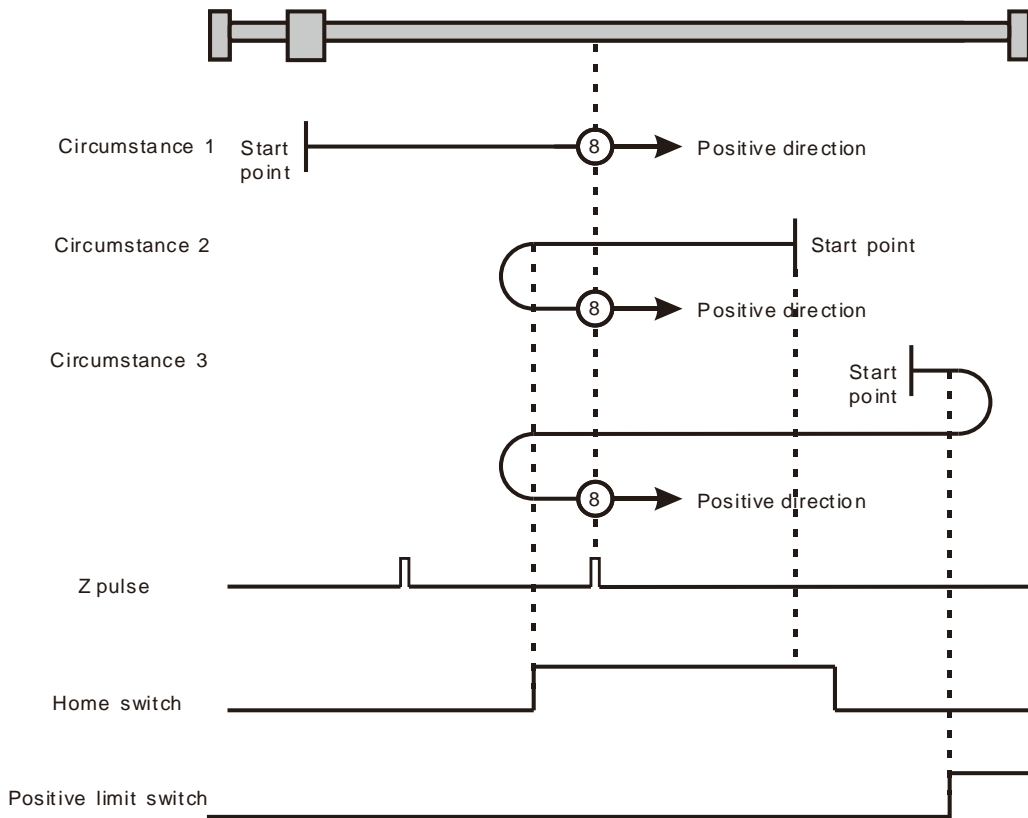

Homing depending on the home switch, positive limit switch and Z pulse (Ⓢ: mode 8)

D

➤ Mode 9

- Circumstance 1 :** MC_Home instruction is executed and the axis moves in the positive direction at the first-phase speed when the home switch is OFF. The axis moves at the second-phase speed when the home switch is ON. The motion direction changes and the axis moves at the second-phase speed when the home switch is OFF. And where the first Z pulse is met is the home position.
- Circumstance 2 :** When the home switch is ON MC_Home instruction is executed and the axis moves in the positive direction at the second-phase speed. The motion direction changes and the axis moves at the second-phase speed when the home switch is OFF. And where the first Z pulse is met is the home position.
- Circumstance 3 :** MC_Home instruction is executed and the axis moves in the positive direction at the first-phase speed when the home switch is OFF. The motion direction changes and the axis moves at the first-phase speed when the home switch is OFF and the positive limit switch is ON. The axis moves at the second-phase speed and where the first Z pulse is met is the home position when the home switch is ON.

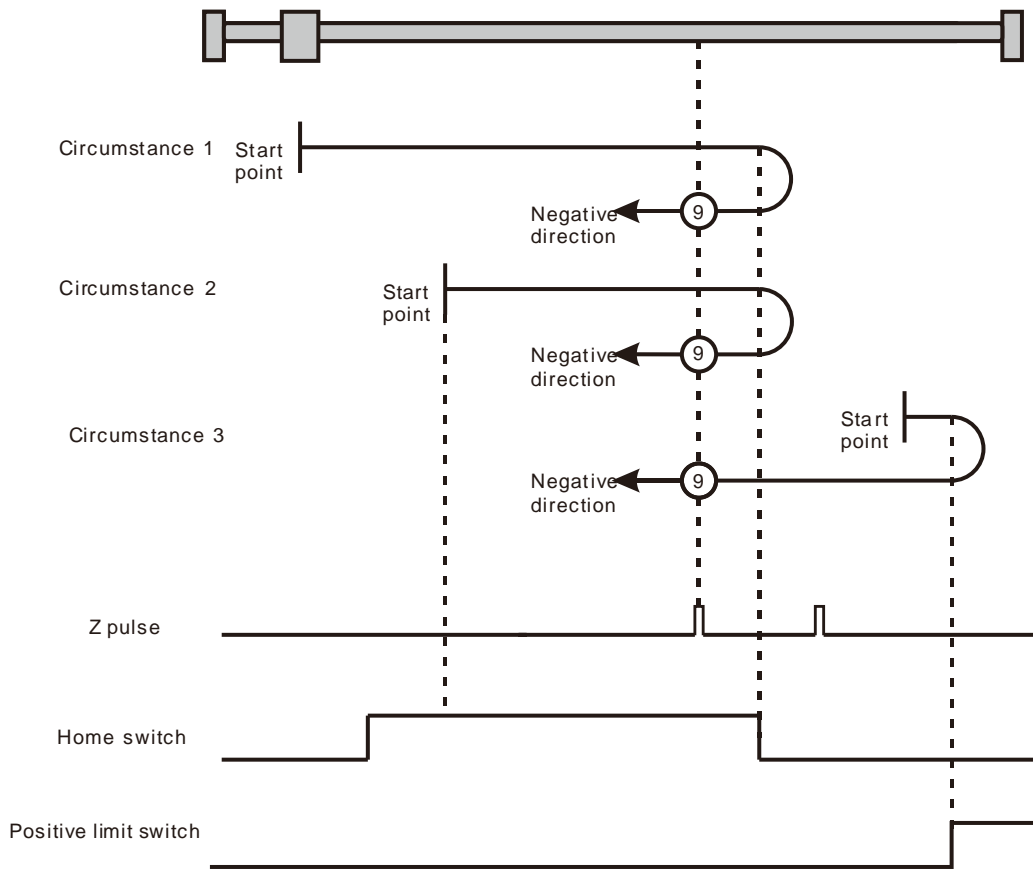

Homing depending on the home switch, positive limit switch and Z pulse (Ⓢ: mode 9)

➤ Mode 10

Circumstance 1 : MC_Home instruction is executed and the axis moves in the positive direction at the first-phase speed when the home switch is OFF. The axis moves at the second-phase speed when the home switch is ON. And where the first Z pulse is met is the home position while the home switch is OFF.

Circumstance 2 : MC_Home instruction is executed and the axis moves in the positive direction at the second-phase speed when the home switch is ON. And where the first Z pulse is met is the home position while the home switch is OFF.

Circumstance 3 : MC_Home instruction is executed and the axis moves in the positive direction at the first-phase speed when the home switch is OFF. The motion direction changes and the axis moves at the first-phase speed when the home switch is OFF and the positive limit switch is ON. The motion direction changes again and the axis moves at the second-phase speed when the home switch is ON. Where the first Z pulse is met is the home position while the home switch is OFF.

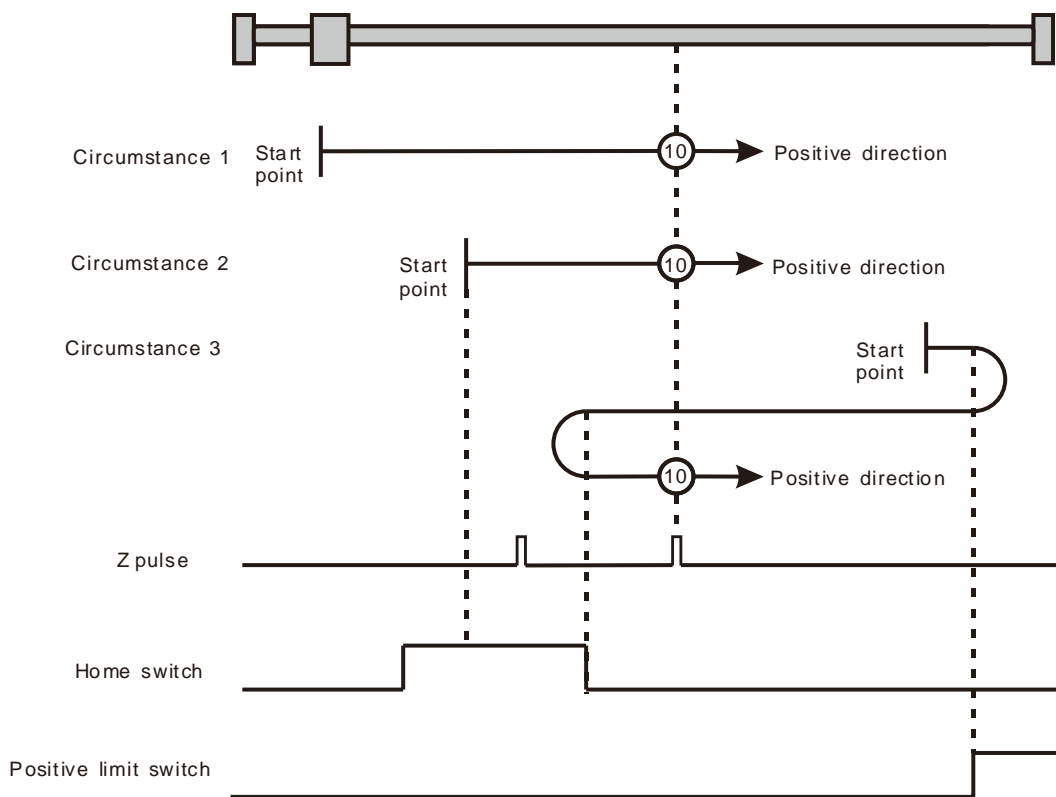

Homing depending on the home switch, positive limit switch and Z pulse (Ⓣ: mode 10)

Mode 11~ mode 14 Homing which depends on the home switch, negative limit switch and Z pulse

➤ Mode 11

- Circumstance 1 :** MC_Home instruction is executed and the axis moves in the negative direction at the first-phase speed when the home switch is OFF. The motion direction changes and the axis moves at the second-phase speed when the home switch is ON. And where the first Z pulse is met is the home position while the home switch is OFF.
- Circumstance 2 :** MC_Home instruction is executed and the axis moves in the positive direction at the second-phase speed while the home switch is ON. And where the first Z pulse is met is the home position while the home switch is OFF.
- Circumstance 3 :** MC_Home instruction is executed and the axis moves in the negative direction at the first-phase speed while the home switch is OFF. The motion direction changes and the axis moves at the first-phase speed while the home switch is OFF and the negative limit switch is ON. The axis moves at the second-phase speed when the home switch is ON. Where the first Z pulse is met is the home position while the home switch is OFF.

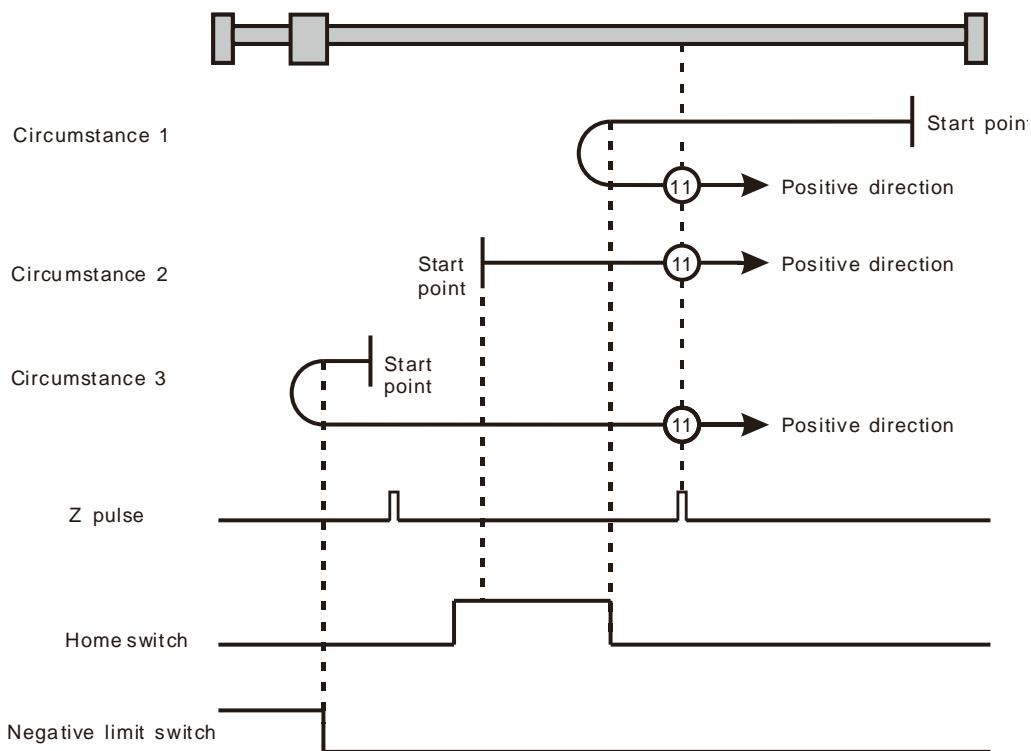

Homing depending on the home switch, negative limit switch and Z pulse (11: mode 11)

➤ Mode 12

- Circumstance 1 :** MC_Home instruction is executed and the axis moves in the negative direction at the first-phase speed when the home switch is OFF. The axis moves at the second-phase speed when the home switch is ON. And where the first Z pulse is met is the home position.
- Circumstance 2 :** MC_Home instruction is executed and the axis moves in the positive direction at the second-phase speed while the home switch is ON. The motion direction changes and the axis moves at the second-phase speed while the home switch is OFF. And where the first Z pulse is met is the home position.
- Circumstance 3 :** MC_Home instruction is executed and the axis moves in the negative direction at the first-phase speed while the home switch is OFF. The motion direction changes and the axis moves at the first-phase speed while the home switch is OFF and the negative limit switch is ON. The axis still moves at the first-phase speed when the home switch is ON. The motion direction changes and the axis moves at the first-phase speed while the home switch is OFF. The axis moves at the second-phase speed while the home switch is ON. And where the first Z pulse is met is the home position.

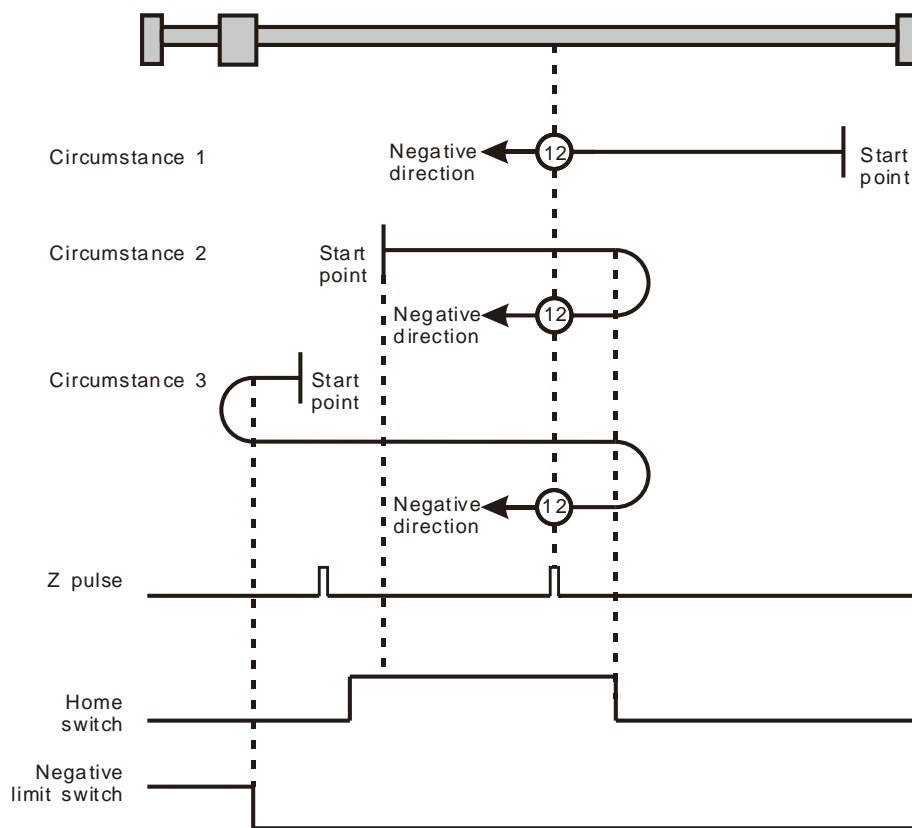

Homing depending on the home switch, negative limit switch and Z pulse (12: mode 12)

D

➤ Mode 13

Circumstance 1 : MC_Home instruction is executed and the axis moves in the negative direction at the first-phase speed while the home switch is OFF. The axis moves at the second-phase speed while the home switch is ON. The motion direction changes and the axis moves at the second-phase speed while the home switch is OFF. And where the first Z pulse is met is the home position.

Circumstance 2 : MC_Home instruction is executed and the axis moves in the negative direction at the second-phase speed while the home switch is ON. The motion direction changes and the axis moves at the second-phase speed while the home switch is OFF. And where the first Z pulse is met is the home position.

Circumstance 3 : MC_Home instruction is executed and the axis moves in the negative direction at the first-phase speed while the home switch is OFF. The motion direction changes and the axis moves at the first-phase speed while the home switch is OFF and the negative limit switch is ON. The axis moves at the second-phase speed and where the first Z pulse is met is the home position when the home switch is ON.

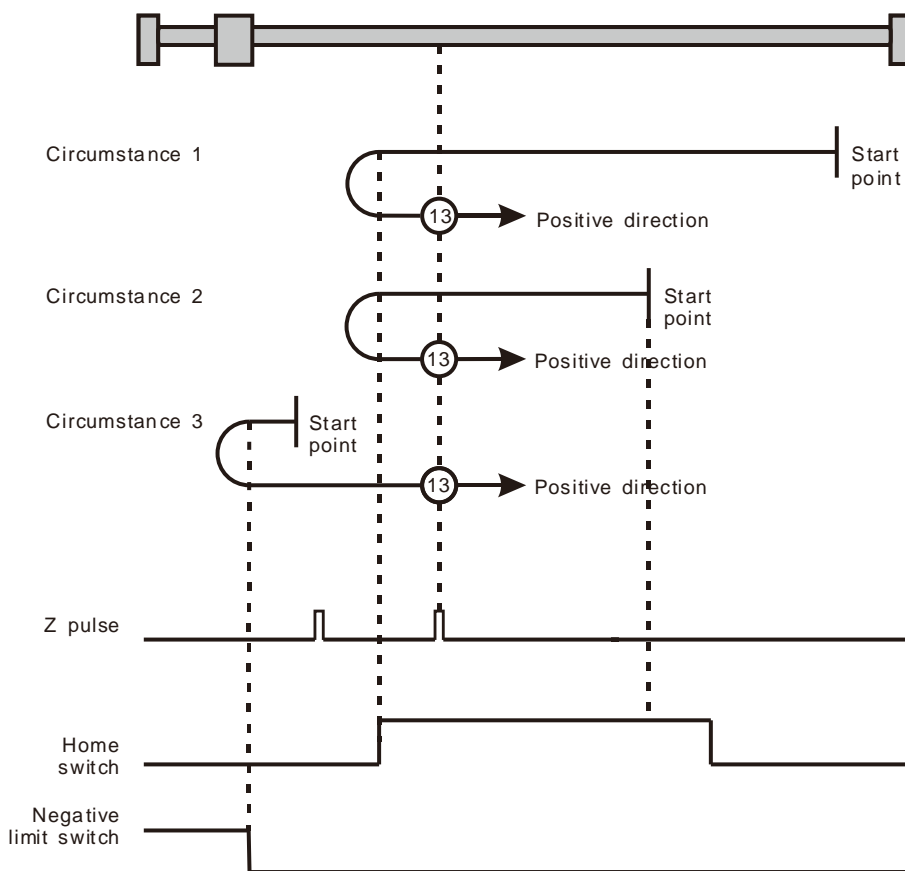

Homing depending on the home switch, negative limit switch and Z pulse (13: mode 13)

➤ Mode 14

Circumstance 1 : MC_Home instruction is executed and the axis moves in the negative direction at the first-phase speed while the home switch is OFF. The axis moves at the second-phase speed once the home switch is ON. And where the first Z pulse is met is the home position while the home switch is OFF.

Circumstance 2 : MC_Home instruction is executed and the axis moves in the negative direction at the second-phase speed while the home switch is ON. Where the first Z pulse is met is the home position while the home switch is OFF.

Circumstance 3 : MC_Home instruction is executed and the axis moves in the negative direction at the first-phase speed while the home switch is OFF. The motion direction changes and the axis moves at the first-phase speed while the home switch is OFF and the negative limit switch is ON. The motion direction changes again and the axis moves at the second-phase speed when the home switch is ON. Where the first Z pulse is met is the home position while the home switch is OFF.

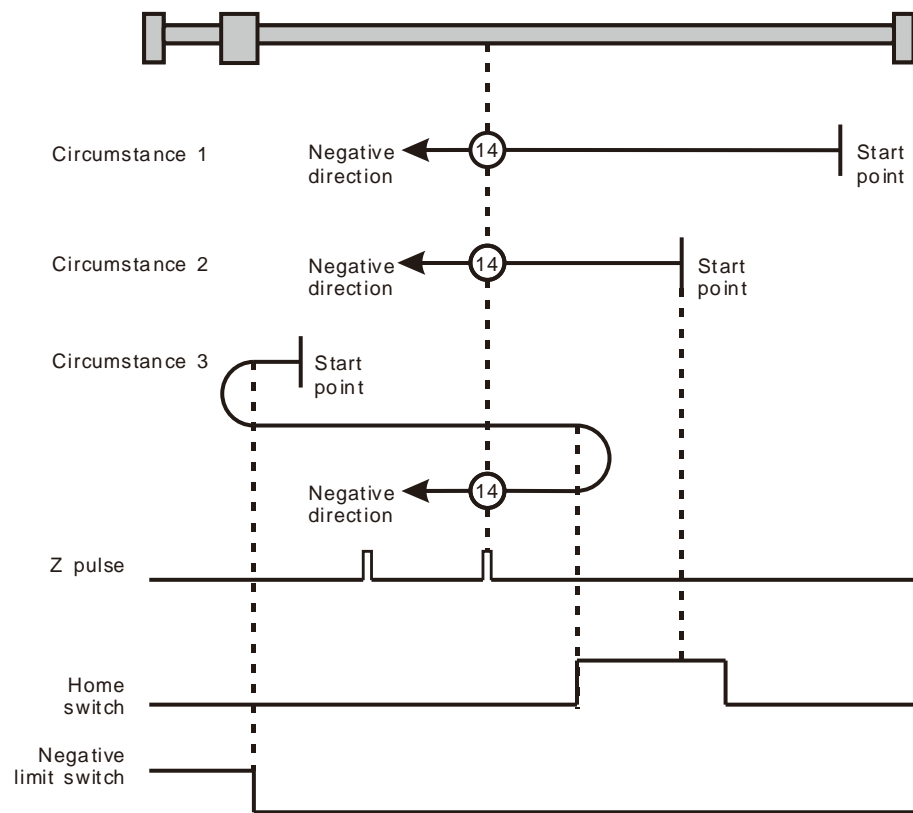

Homing depending on the home switch, negative limit switch and Z pulse (14: mode 14)

Mode 15 and mode 16 are reserved for future development.

Mode 17~mode 30 Homing which has nothing to do with Z pulse

In mode 17~mode 30 which are respectively similar to mode1~mode 14 mentioned previously, the axis has nothing to do with Z pulse but the relevant home switch and limit switch status while returning to the home position. Mode 17 is similar to mode 1, mode 18 is similar to mode 2, mode 19 & mode 20 is similar to mode 3, mode 21 & mode 22 is similar to mode 5, mode 23 & mode 24 is similar to mode 7, mode 25 & mode 26 is similar to mode 9, mode 27 & mode 28 is similar to mode 11, and mode 29 & mode 30 are similar to 13.

➤ Mode 17 Homing which depends on the negative limit switch

Circumstance 1 : MC_Home instruction is executed when the negative limit switch is OFF and the axis moves in the negative direction at the first-phase speed. The motion direction changes and the axis moves at the second-phase speed when the axis encounters that the negative limit switch is ON. Where the servo is when the negative limit switch is OFF is the home position.

Circumstance 2 : MC_Home instruction is executed when the negative limit switch is ON and the axis moves in the positive direction at the second-phase speed. Where the servo is is the home position when the negative limit switch is OFF.

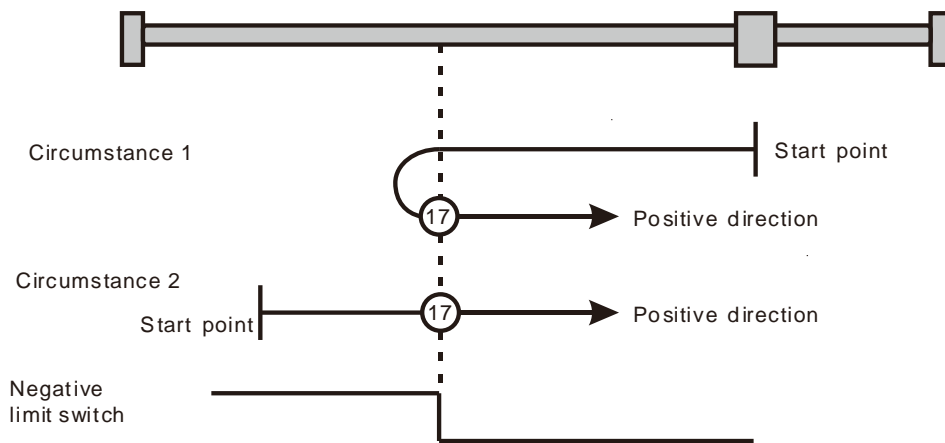

Homing depending on the negative limit switch (17: mode 17)

➤ Mode 18 Homing which depends on the positive limit switch

Circumstance 1 : MC_Home instruction is executed when the positive limit switch is OFF and the axis moves in the positive direction at the first-phase speed. The motion direction changes and the axis moves at the second-phase speed when the axis encounters that the positive limit switch is ON. Where the servo is is the home position while the positive limit switch is OFF.

Circumstance 2 : MC_Home instruction is executed when the positive limit switch is ON and the axis moves in the negative direction at the second-phase speed. Where the servo is is the home position while the positive limit switch is OFF.

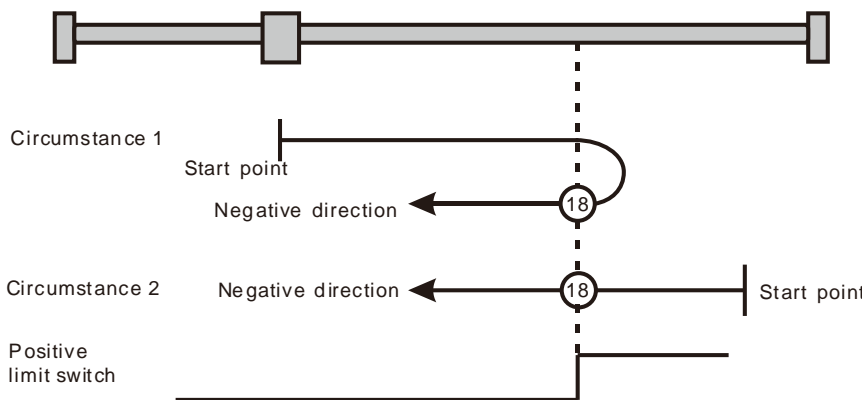

Homing depending on the positive limit switch (18: mode 18)

➤ Mode 19

Circumstance 1 : MC_Home instruction is executed and the axis moves in the positive direction at the first-phase speed while the home switch is OFF. The motion direction changes and the axis moves at the second-phase speed once the home switch becomes ON. And where the axis stands is the home position at the moment the home switch becomes OFF.

Circumstance 2 : MC_Home instruction is executed and the axis directly moves in the negative direction at the second-phase speed while the home switch is ON. And where the axis stands is the home position at the moment when the home switch becomes OFF.

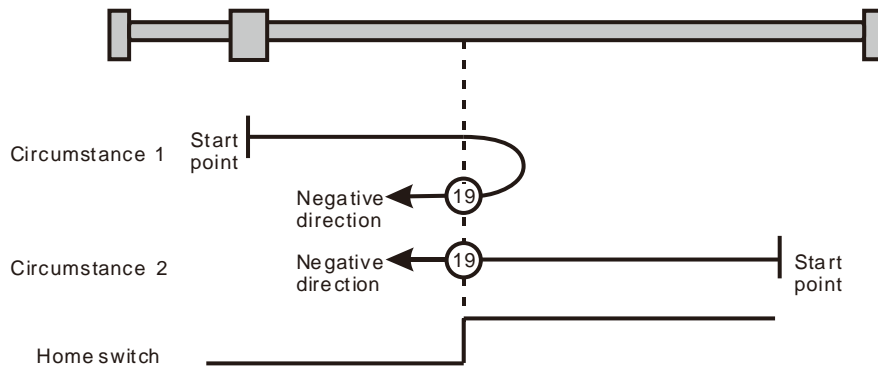

Homing depending on the home switch (19: mode 19)

➤ Mode 20

Circumstance 1 : MC_Home instruction is executed when the home switch is OFF and the axis moves in the positive direction at the first-phase speed. Where the servo is is the home position when the home switch is ON.

Circumstance 2 : MC_Home instruction is executed when the home switch is ON and the axis moves in the negative direction at the second-phase speed. The motion direction changes and the axis moves at the second-phase speed when the home switch becomes OFF. Where the servo is is the home position when the home switch is ON.

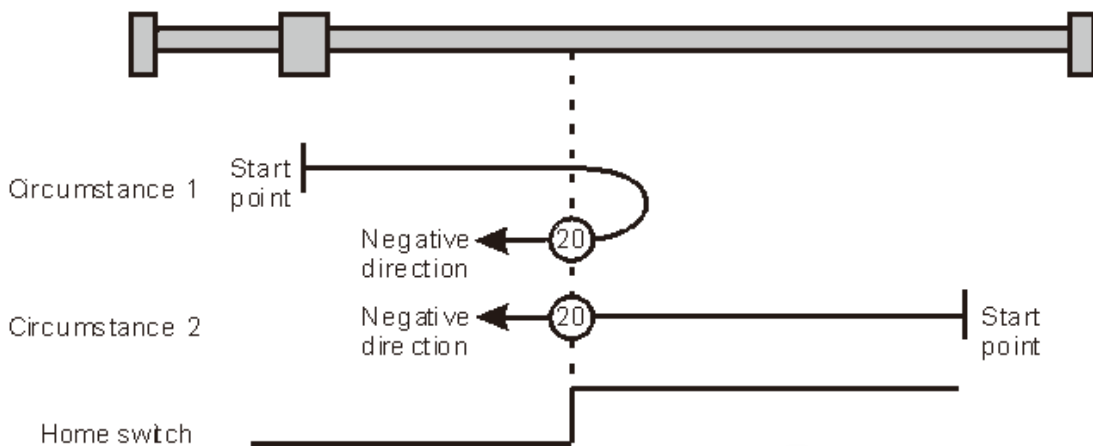

Homing depending on the home switch (20: mode 20)

➤ Mode 21

Circumstance 1 : MC_Home instruction is executed and the axis moves in the negative direction at the first-phase speed while the home switch is OFF. The motion direction changes and the

axis moves at the second-phase speed once the home switch becomes ON. And where the axis stands is the home position at the moment the home switch becomes OFF.

Circumstance 2 : MC_Home instruction is executed and the axis moves in the positive direction at the second-phase speed while the home switch is ON. And where the axis stands is the home position at the moment the home switch becomes OFF.

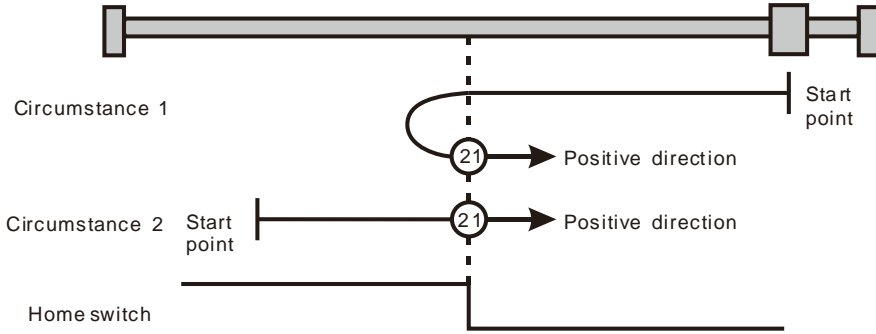

Homing depending on the home switch (21: mode 21)

➤ Mode 22

Circumstance 1 : MC_Home instruction is executed while the home switch is ON and the axis moves in the positive direction at the second-phase speed. The motion direction changes and the axis moves at the second-phase speed once the home switch becomes OFF. Where the axis stands is the home position when the home switch is ON.

Circumstance 2 : MC_Home instruction is executed while the home switch is OFF and the axis moves in the negative direction at the first-phase speed. Where the axis stands is the home position when the home switch becomes ON.

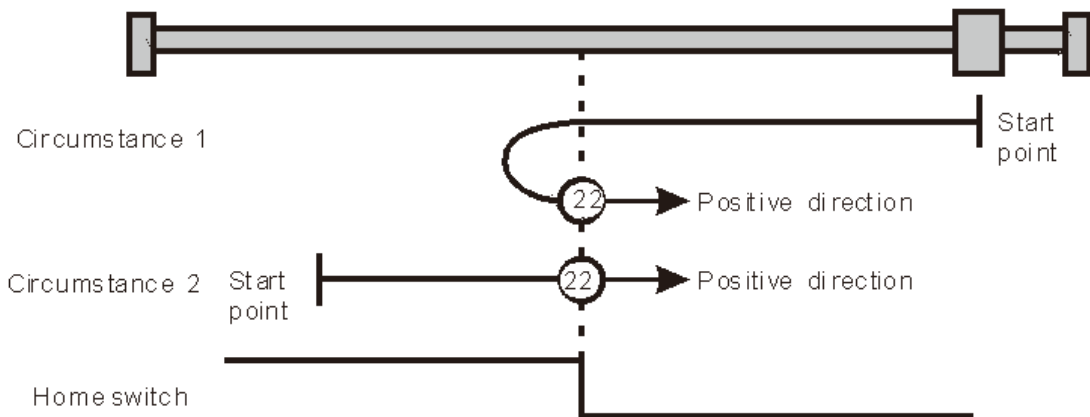

Homing depending on the home switch (22: mode 22)

Homing depending on the home switch (22: mode 22)

➤ Mode 23

Circumstance 1 : MC_Home instruction is executed while the home switch is OFF and the axis moves in the positive direction at the first-phase speed. The motion direction changes and the

axis moves at the second-phase speed once the home switch becomes ON. Where the axis stands is the home position when the home switch is OFF.

Circumstance 2 : MC_Home instruction is executed while the home switch is ON and the axis moves in the negative direction at the second-phase speed. And where the axis stands is the home position when the home switch becomes OFF.

Circumstance 3 : MC_Home instruction is executed while the home switch is OFF. The axis moves in the positive direction at the first-phase speed. The motion direction changes and the axis moves at the first-phase speed when the home switch is OFF and the positive limit switch is ON. When the home switch is ON, the axis starts to move at the second-phase speed. Where the axis stands is the home position when the home switch is OFF.

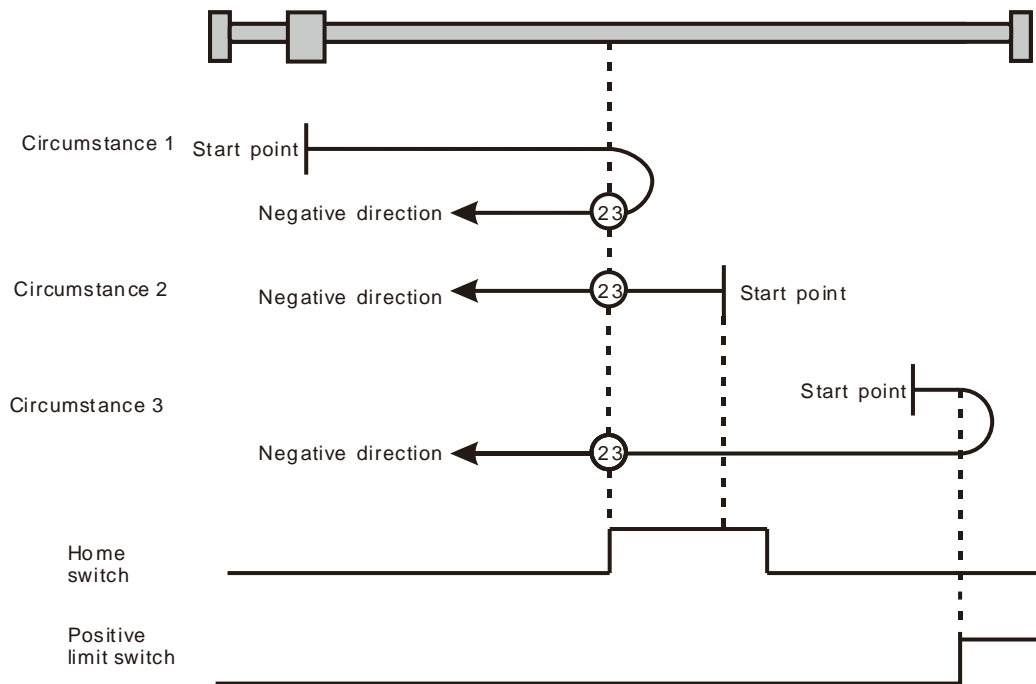

Homing depending on the home switch and positive limit switch (23: mode 23)

➤ Mode 24

Circumstance 1 : MC_Home instruction is executed while the home switch is OFF and the axis starts to move in the positive direction at the first-phase speed. Where the axis stands is the home position when the home switch is ON.

Circumstance 2 : MC_Home instruction is executed while the home switch is ON and the axis moves in the negative direction at the second-phase speed. The motion direction changes and the axis moves at the second-phase speed when the home switch is OFF. Where the axis stands is the home position when the home switch is ON.

Circumstance 3 : MC_Home instruction is executed while the home switch is OFF. The axis moves in the positive direction at the first-phase speed. The motion direction changes and the axis moves at the first-phase speed when the home switch is OFF and the positive limit switch is ON. When the home switch is ON, the axis still moves at the first-phase speed. The motion direction changes and the axis moves at the first-phase speed when the home switch is OFF. Where the axis stands is the home position when the home switch is ON.

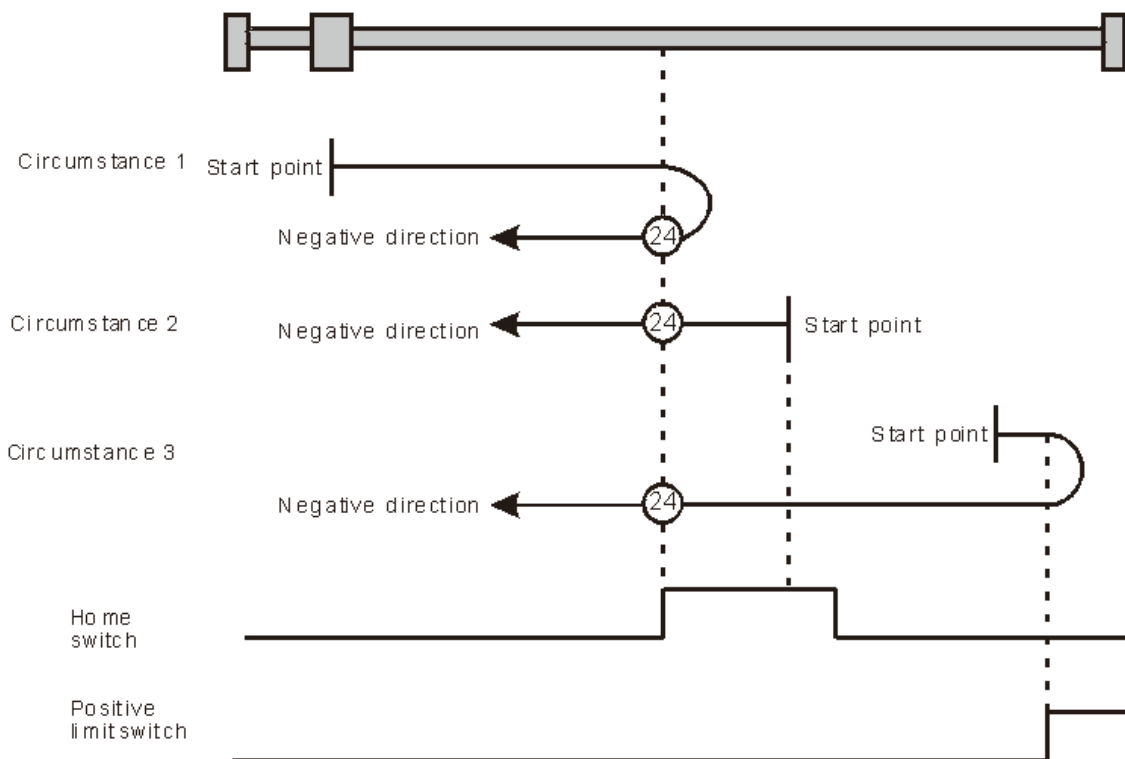

Homing depending on the home switch and positive limit switch (24: mode 24)

➤ Mode 25

Circumstance 1 : MC_Home instruction is executed while the home switch is OFF and the axis starts to move in the positive direction at the first-phase speed. The axis moves at the second-phase speed when the home switch is ON. The motion direction changes and the axis moves at the second-phase speed when the home switch is OFF. Where the axis stands is the home position when the home switch is ON.

Circumstance 2 : MC_Home instruction is executed while the home switch is ON and the axis moves in the positive direction at the second-phase speed. The motion direction changes and the axis moves at the second-phase speed when the home switch is OFF. Where the axis stands is the home position when the home switch is ON.

Circumstance 3 : MC_Home instruction is executed while the home switch is OFF. The axis moves in the positive direction at the first-phase speed. The motion direction changes and the axis moves at the first-phase speed when the home switch is OFF and the positive limit switch is ON. Where the axis stands is the home position when the home switch is ON.

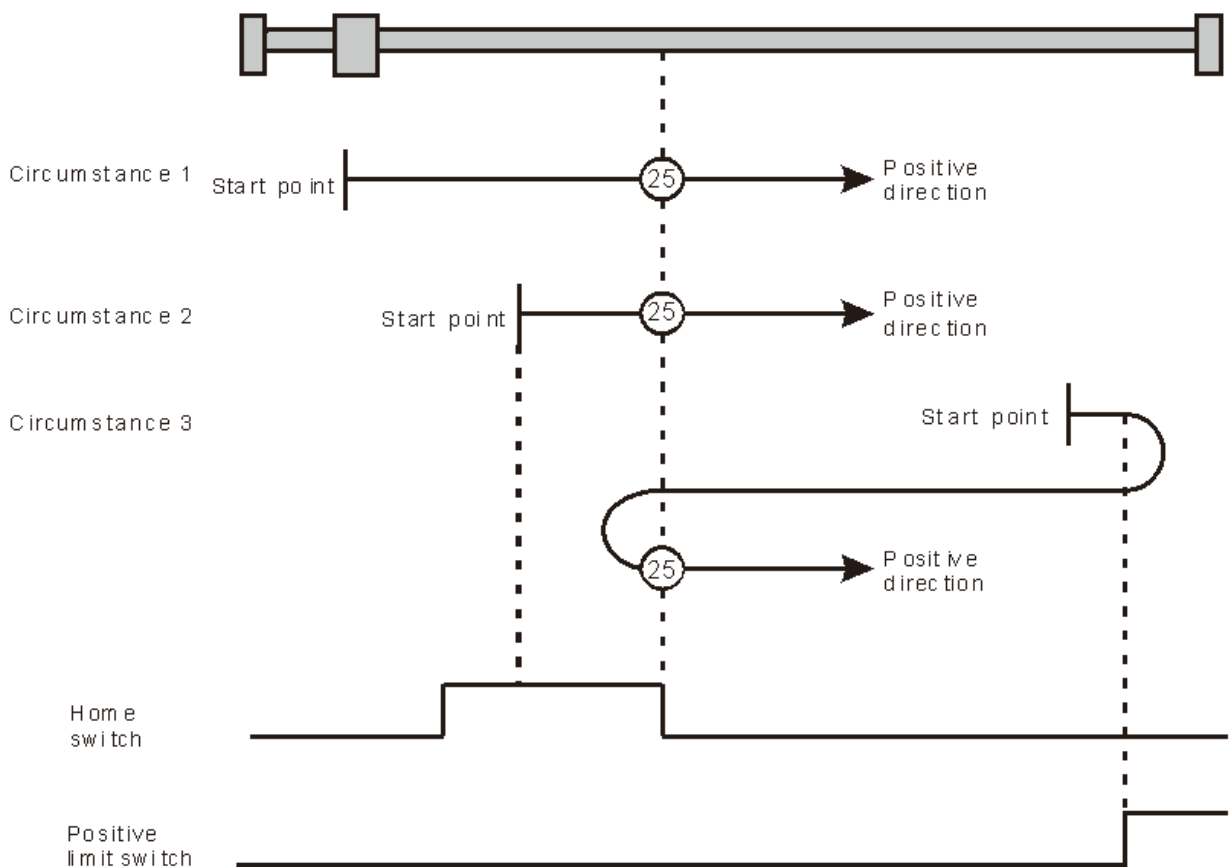

Homing depending on the home switch and positive limit switch (25: mode 25)

➤ Mode 26

Circumstance 1 : MC_Home instruction is executed while the home switch is OFF and the axis starts to move in the positive direction at the first-phase speed. The axis moves at the second-phase speed when the home switch is ON. Where the axis stands is the home position when the home switch is OFF.

Circumstance 2 : MC_Home instruction is executed while the home switch is ON and the axis moves in the positive direction at the second-phase speed. Where the axis stands is the home position when the home switch is OFF.

Circumstance 3 : MC_Home instruction is executed while the home switch is OFF. The axis moves in the positive direction at the first-phase speed. The motion direction changes and the axis moves at the first-phase speed when the home switch is OFF and the positive limit switch is ON. The motion direction changes again and the axis moves at the second-phase speed when the home switch is ON. Where the axis stands is the home position when the home switch is OFF.

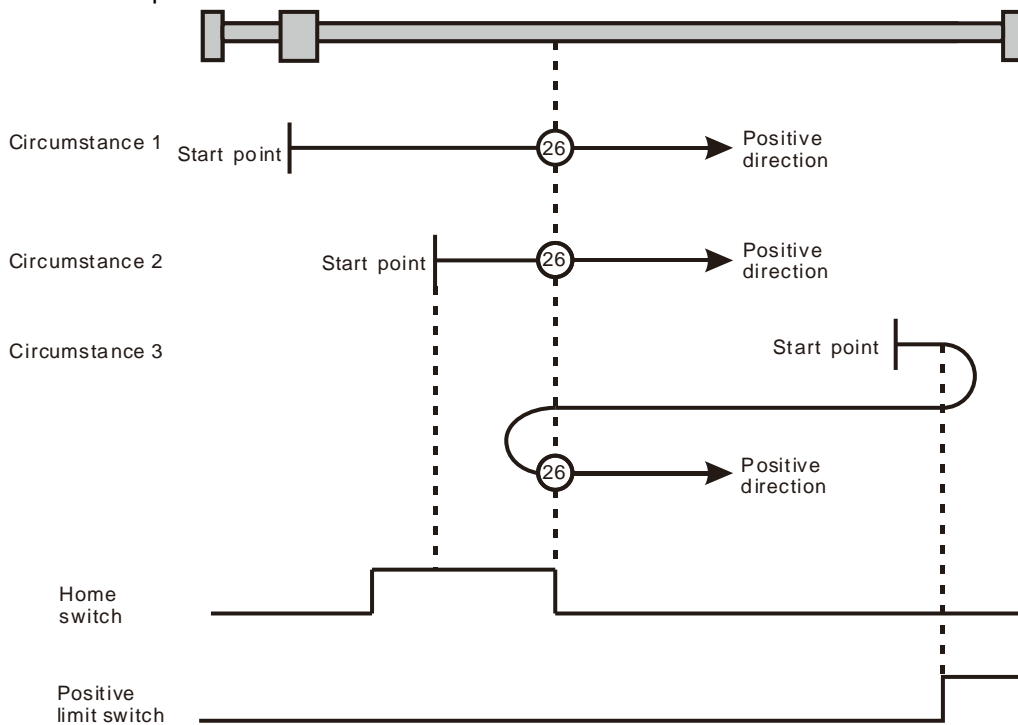

Homing depending on the home switch and positive limit switch (26: mode 26)

D

➤ Mode 27

Circumstance 1 : MC_Home instruction is executed while the home switch is OFF and the axis starts to move in the negative direction at the first-phase speed. The motion direction changes and the axis moves at the second-phase speed when the home switch is ON. Where the axis stands is the home position when the home switch is OFF.

Circumstance 2 : MC_Home instruction is executed while the home switch is ON and the axis moves in the positive direction at the second-phase speed. Where the axis stands is the home position when the home switch is OFF.

Circumstance 3 : MC_Home instruction is executed while the home switch is OFF. The axis moves in the negative direction at the first-phase speed. The motion direction changes and the axis moves at the first-phase speed when the home switch is OFF and the negative limit switch is ON. When the home switch is ON, the axis starts to move at the second-phase speed. Where the axis stands is the home position when the home switch is OFF.

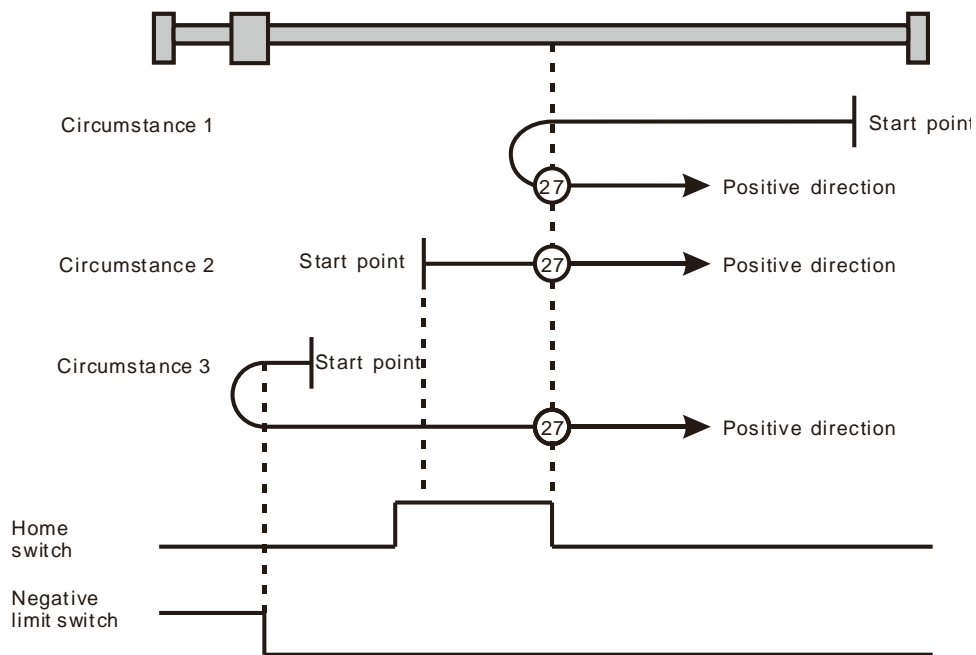

Homing depending on the home switch and negative limit switch (27: mode 27)

➤ Mode 28

Circumstance 1 : MC_Home instruction is executed while the home switch is OFF and the axis starts to move in the negative direction at the first-phase speed. Where the axis stands is the home position when the home switch is ON.

Circumstance 2 : MC_Home instruction is executed while the home switch is ON and the axis moves in the positive direction at the second-phase speed. The motion direction changes and the axis moves at the second-phase speed when the home switch is OFF. Where the axis stands is the home position when the home switch is ON.

Circumstance 3 : MC_Home instruction is executed while the home switch is OFF. The axis moves in the negative direction at the first-phase speed. The motion direction changes and the axis moves at the first-phase speed when the home switch is OFF and the negative limit switch is ON. When the home switch is ON, the axis still moves at the first-phase speed. The motion direction changes and the axis moves at the first-phase speed when the home switch is OFF. Where the axis stands is the home position when the home switch is ON.

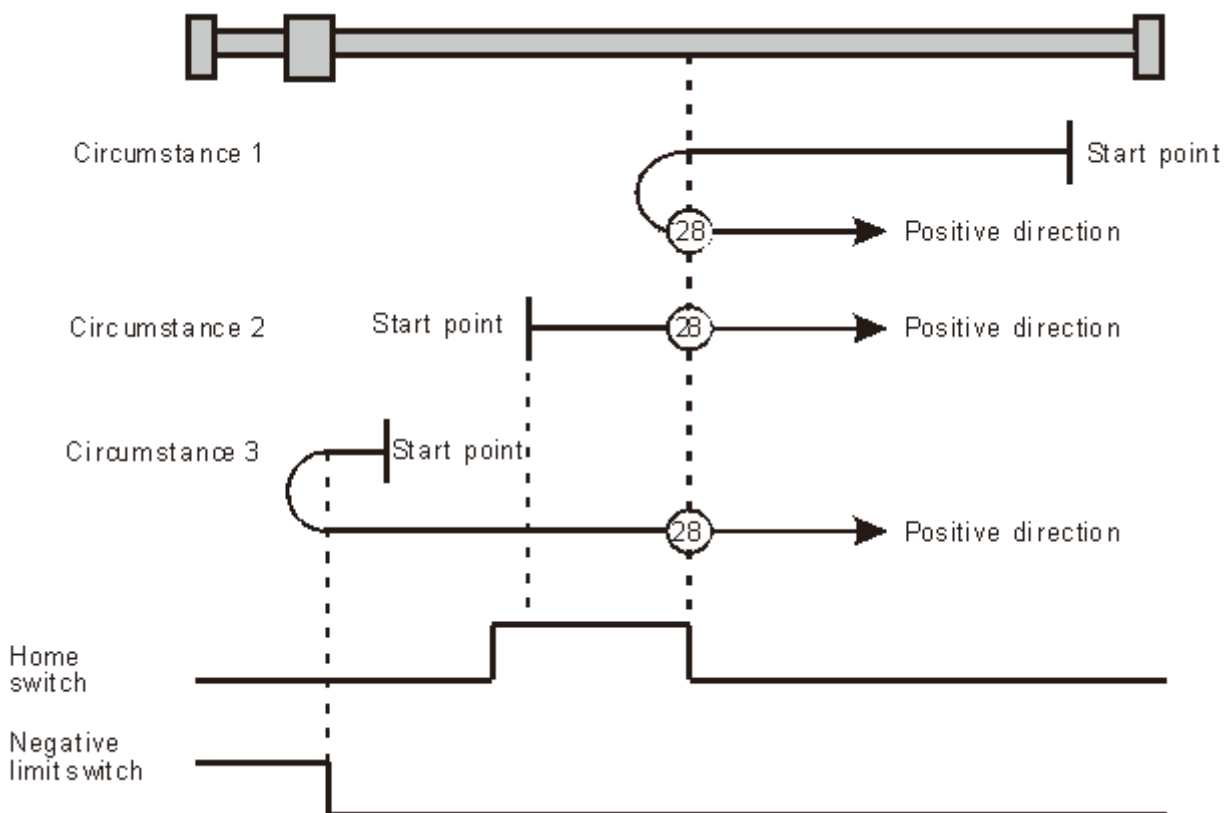

Homing depending on the home switch and negative limit switch (28: mode 28)

➤ Mode 29

Circumstance 1 : MC_Home instruction is executed while the home switch is OFF and the axis starts to move in the negative direction at the first-phase speed. When the home switch is ON, the axis starts to move at the second-phase speed. The motion direction changes and the axis moves at the second-phase speed when the home switch is OFF. Where the axis stands is the home position when the home switch is ON.

Circumstance 2 : MC_Home instruction is executed while the home switch is ON and the axis moves in the negative direction at the second-phase speed. The motion direction changes and the axis moves at the second-phase speed when the home switch is OFF. Where the axis stands is the home position when the home switch is ON.

Circumstance 3 : MC_Home instruction is executed while the home switch is OFF. The axis moves in the negative direction at the first-phase speed. The motion direction changes and the axis moves at the first-phase speed when the home switch is OFF and the negative limit switch is ON. Where the axis stands is the home position when the home switch is ON.

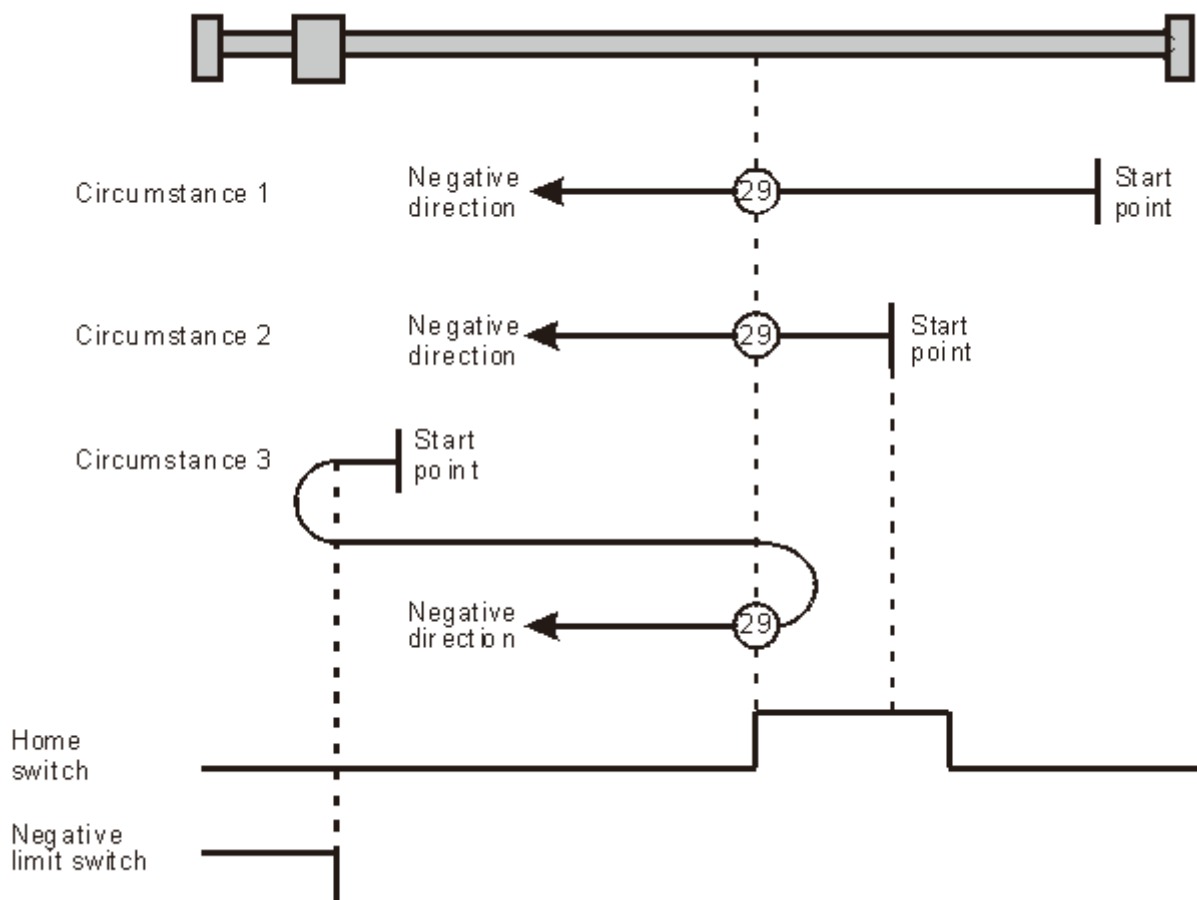

Homing depending on the home switch and negative limit switch (29: mode 29)

➤ Mode 30

- Circumstance 1 :** MC_Home instruction is executed while the home switch is OFF and the axis starts to move in the negative direction at the first-phase speed. When the home switch is ON, the axis starts to move at the second-phase speed. Where the axis stands is the home position when the home switch is OFF.
- Circumstance 2 :** MC_Home instruction is executed while the home switch is ON and the axis moves in the negative direction at the second-phase speed. Where the axis stands is the home position when the home switch is OFF.
- Circumstance 3 :** MC_Home instruction is executed while the home switch is OFF. The axis moves in the negative direction at the first-phase speed. The motion direction changes and the axis moves at the first-phase speed when the home switch is ON and the negative limit switch is ON. When the home switch is ON, the motion direction changes again and the axis moves at the second-phase speed. Where the axis stands is the home position when the home switch is OFF.

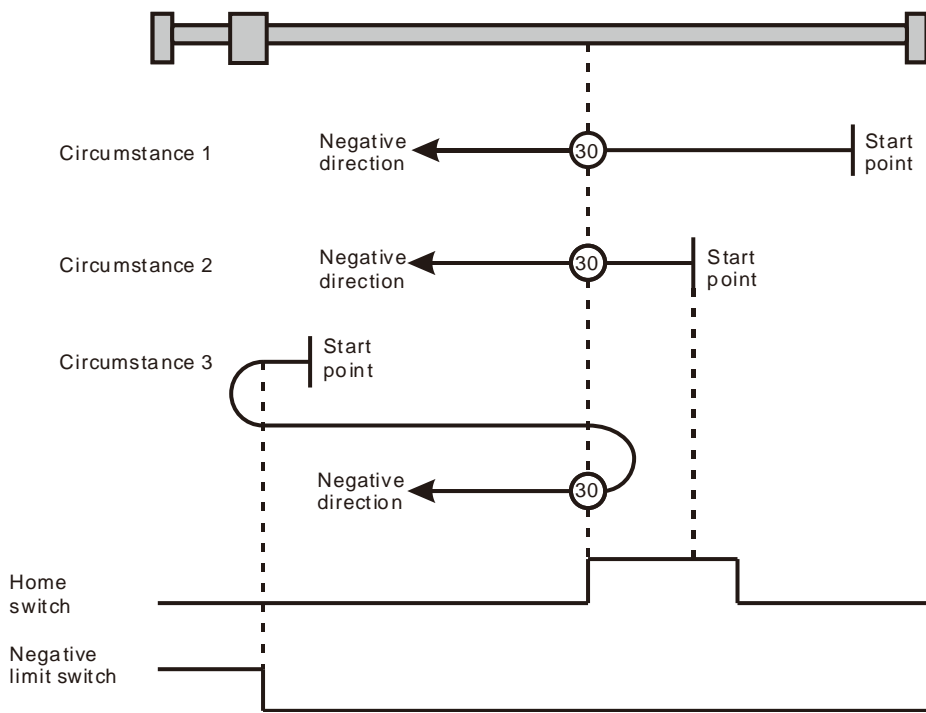

Homing depending on the home switch and negative limit switch (30: mode 30)

Mode 31 and mode 32 Reserved for future development.

Mode 33 ~ mode 34 Homing which depends on Z pulse

➤ Mode 33

In mode 33, MC_Home instruction is executed and the axis moves at the second-phase speed in the negative direction. And the place where the axis stands is the home position once the first Z pulse is met.

➤ Mode 34

In mode 34, MC_Home instruction is executed and the axis moves at the second-phase speed in the positive direction. And the place where the axis stands is the home position once the first Z pulse is met.

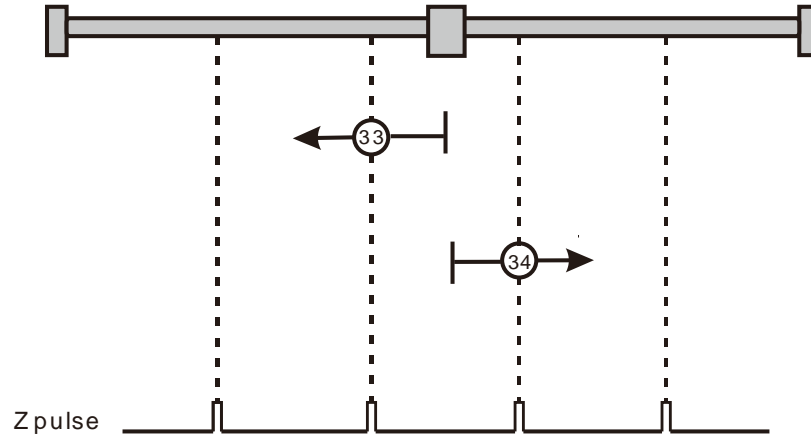

Homing depending on Z pulse (33: mode 33, 34: mode 34)

➤ Mode 35 Homing which depends on the current position

In mode 35, MC_Home instruction is executed, the axis does not move and its current position is regarded as the home position.

MEMO

D





Appendix E List of Accessories

Table of Contents

E.1	Accessories for CANopen Communication.....	E-2
E.2	Accessories for PROFIBUS DP Communication	E-4
E.3	Accessories for DeviceNet Communication	E-4

E.1 Accessories for CANopen Communication

● Cables

Figure	Model	Length	Diameter (AWG)
	UC-DN01Z-01A	305M	2#15 · 2#18 SHLD PVC (Thick cable)
	UC-DN01Z-02A	305M	2#22 · 2#24 SHLD PVC (Thin cable)
	UC-CMC003-01A	0.3M	4#26 · 1#24 PVC (Thin cable)
	UC-CMC005-01A	0.5M	4#26 · 1#24 PVC (Thin cable)
	UC-CMC010-01A	1.0M	4#26 · 1#24 PVC (Thin cable)
	UC-CMC015-01A	1.5M	4#26 · 1#24 PVC (Thin cable)
	UC-CMC020-01A	2.0M	4#26 · 1#24 PVC (Thin cable)
	UC-CMC030-01A	3.0M	4#26 · 1#24 PVC (Thin cable)
	UC-CMC050-01A	5.0M	4#26 · 1#24 PVC (Thin cable)
	UC-CMC100-01A	10.0M	4#26 · 1#24 PVC (Thin cable)
	UC-CMC200-01A	20.0M	4#26 · 1#24 PVC (Thin cable)

Notes:



- The maximum cable length for purchase is 305M per reel and minimum length is 1M with metre as the unit.
- UC-DN01Z-01A and UC-DN01Z-02A can be used as the main-line cable as well as the branch-line cable. The maximum communication distances that they support are different.
The maximum communication distances the two cables support at different CANopen transmission speed are displayed as follows.

CANopen transmission speed (bit/s)	125K	250K	500K	1M
Max. communication distance for UC-DN01Z-01A (m)	500	250	100	40
Max. communication distance for UC-DN01Z-02A (m)	100	100	100	40

- The maximum communication distance at a transmission speed is regulated in the CANopen protocol. The relationships between maximum communication distances and transmission speeds are shown in the following table.

Transmission speed (bit/s)	10K	20K	50K	125K	250K	500K	800K	1M
Max. communication distance (m)	5000	2500	1000	500	250	100	50	40

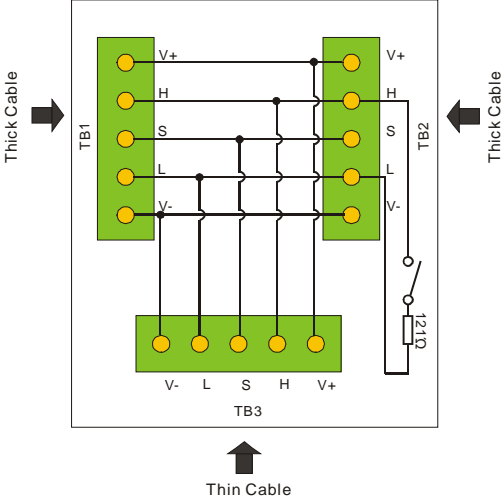
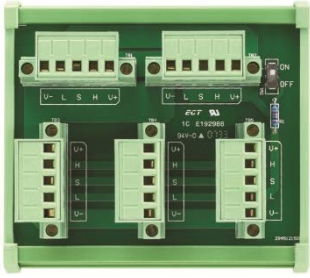
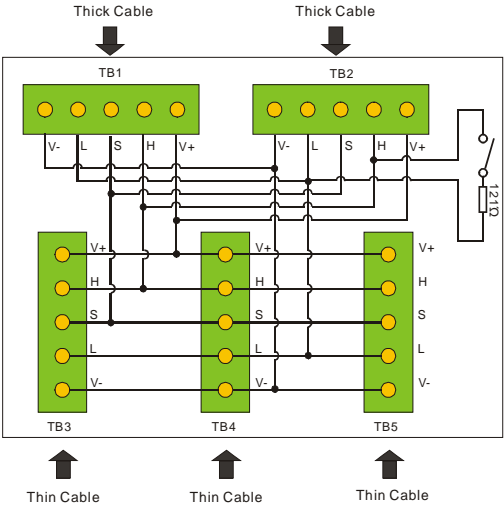
● Distribution box

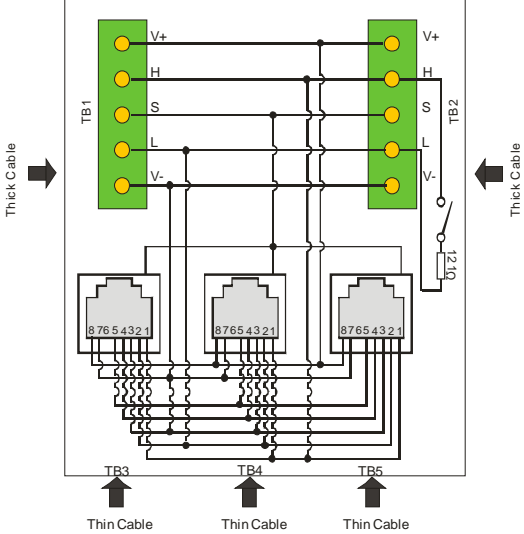
	Model	Circuit figure
TAP-CN01		
TAP-CN02		
TAP-CN03		
Connector	Removable terminals (5.08mm)	
Terminal resistor	120Ω	

● **Terminal resistor**

As suggested in the CANopen protocol, the two ends of the CANopen communication cable should connect a terminal resistor of 120Ω (1/4W) respectively in order to match the impedance of the communication signal and reduce the signal reflection interference in normal signal transmission.

- The terminal resistor connected to the start of the cable:
The terminal resistor on the distribution box can be used just by setting the terminal resistor switch to ON.
- The terminal resistor connected to the terminal end of the cable:
A terminal resistor TAP-TR01 is needed for connecting to the other end of the cable.
- The model of a terminal resistor: TAP-TR01, resistance value: 120Ω (1/4W) as shown below



E.2 Accessories for PROFIBUS DP Communication

● **Connector**

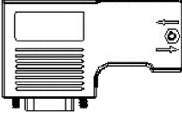
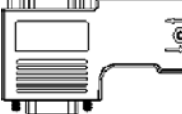
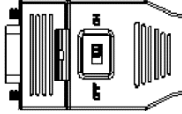
	①	②	③
Model	 UN-03PF-01A	 UN-03PF-02A	 UN-03PF-03A
Connector	Male DB9 connector	Male DB9 connector	Male DB9 connector
Program planning connector	--	Female DB9 connector	--
Terminal resistor*1	120Ω	120Ω	120Ω

*1. : Please set the switches of the connectors to ON when the connectors are placed at two ends of the PROFIBUS network. Set the switches of the connectors to OFF if they are not placed at two ends of the PROFIBUS network.

● **Cable**

	Model	Length	Diameter
	UC-PF01Z-01A	305M	1PR #22 AWG FRFPE FRPE

Note: The maximum cable length for purchase is 305M per reel and minimum length is 1M with Metre as the unit.

E.3 Accessories for DeviceNet Communication

● **Cable**

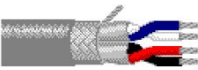
Figure	Model	Length	Diameter (AWG)
	UC-DN01Z-01A	305M	2#15 · 2#18 SHLD PVC (Thick)
	UC-DN01Z-02A	305M	2#22 · 2#24 SHLD PVC (Thin)

Notes:

1. The maximum cable length for purchase is 305M per reel and minimum length is 1M with metre as the unit.

2. UC-DN01Z-01A and UC-DN01Z-02A can be used as the main-line cable as well as the branch-line cable. The maximum communication distances that they support are different. The maximum communication distances the two cables support at different DeviceNet transmission speed are displayed as follows.

DeviceNet transmission speed (bit/s)	125K	250K	500K
Max. communication distance for UC-DN01Z-01A (m)	500	250	100
Max. communication distance for UC-DN01Z-02A (m)	100	100	100

3. The maximum communication distance at a transmission speed is regulated in the DeviceNet protocol. The relationships between maximum communication distances and transmission speeds are shown in the following table.

Transmission speed (bit/s)	10K	20K	50K	125K	250K	500K
Max. communication distance (m)	5000	2500	1000	500	250	100

● Distribution box

Model	Circuit figure
TAP-CN01	
TAP-CN02	

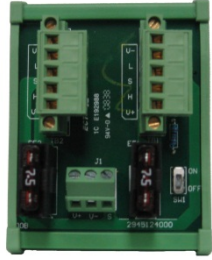
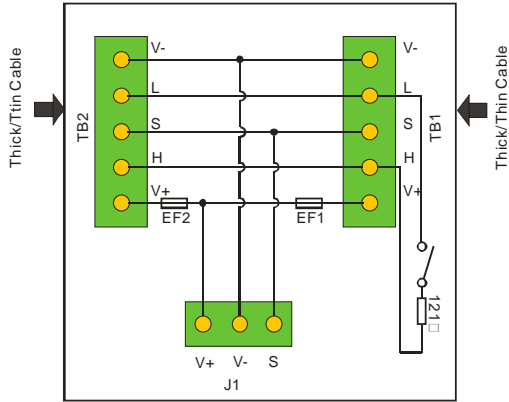
Model		Circuit figure
<p>TAP-CP01 (Power distribution box)</p>		
<p>Connector</p>	<p>Removable terminals (5.08mm)</p>	
<p>Terminal resistor</p>	<p>120Ω</p>	

● **Terminal resistor**

As required in the DeviceNet protocol, the two ends of the DeviceNet communication cable should connect a terminal resistor of 120Ω (1/4W) respectively.

1. The terminal resistor connected to the start of the cable:
The terminal resistor on the distribution box can be used by setting the terminal resistor switch to ON.
2. The terminal resistor connected to the terminal end of the cable:
A terminal resistor of 120Ω (1/4W) is needed for connecting to the terminal end of the cable.